



ROYAL CANADIAN AIR CADETS

PROFICIENCY LEVEL FOUR INSTRUCTIONAL GUIDES

(ENGLISH)

(Supersedes A-CR-CCP-804/PF-001 dated 2009-06-01)

Cette publication est disponible en français sous le numéro A-CR-CCP-804/PF-002.

Issued on Authority of the Chief of the Defence Staff

Canada



NOTICE

This documentation has been reviewed by the technical authority and does not contain controlled goods. Disclosure notices and handling instructions originally received with the document shall continue to apply.

AVIS

Cette documentation a été révisée par l'autorité technique et ne contient pas de marchandises contrôlées. Les avis de divulgation et les instructions de manutention reçues originalement doivent continuer de s'appliquer.



ROYAL CANADIAN AIR CADETS

PROFICIENCY LEVEL FOUR INSTRUCTIONAL GUIDES

(ENGLISH)

(Supersedes A-CR-CCP-804/PF-001 dated 2009-06-01)

Cette publication est disponible en français sous le numéro A-CR-CCP-804/PF-002.

Issued on Authority of the Chief of the Defence Staff

**OPI: D Cdts & JCR 4 – Senior Staff Officer Youth Programs
Development**

2015-09-01

Canada



NOTICE

This documentation has been reviewed by the technical authority and does not contain controlled goods. Disclosure notices and handling instructions originally received with the document shall continue to apply.

AVIS

Cette documentation a été révisée par l'autorité technique et ne contient pas de marchandises contrôlées. Les avis de divulgation et les instructions de manutention reçues originellement doivent continuer de s'appliquer.

LIST OF EFFECTIVE PAGES

Insert latest changed pages and dispose of superseded pages in accordance with applicable orders.

NOTE

The portion of the text affected by the latest change is indicated by a black vertical line in the margin of the page. Changes to illustrations are indicated by miniature pointing hands or black vertical lines.

Dates of issue for original and changed pages are:

Original.....	0	2015-09-01	Ch.....	3
Ch.....	1		Ch.....	4
Ch.....	2		Ch.....	5

Zero in Change No. column indicates an original page. Total number of pages in this publication is 1451 consisting of the following:

Page No.	Change No.	Page No.	Change No.
Cover page.....	0	M403.06B-1 to M403.06B-6.....	0
Title.....	0	C403.01-1 to C403.01-4.....	0
A to E.....	0	C403.01A-1 to C403.01A-2.....	0
i to xii.....	0	C403.01B-1 to C403.01B-10.....	0
400-1 to 400-2.....	0	C403.01B1-1 to C403.01B1-2.....	0
X01-1 to X01-2.....	0	C403.01B2-1 to C403.01B2-2.....	0
X02-1 to X02-2.....	0	C403.01B3-1 to C403.01B3-2.....	0
M403.01-1 to M403.01-8.....	0	C403.01B4-1 to C403.01B4-2.....	0
M403.01A-1 to M403.01A-2.....	0	C403.01B5-1 to C403.01B5-4.....	0
M403.02-1 to M403.02-12.....	0	C403.01B6-1 to C403.01B6-2.....	0
M403.02A-1 to M403.02A-2.....	0	C403.01C-1 to C403.01C-10.....	0
M403.02B-1 to M403.02B-4.....	0	C403.01C1-1 to C403.01C1-2.....	0
M403.02C-1 to M403.02C-2.....	0	C403.01D-1 to C403.01D-8.....	0
M403.02D-1 to M403.02D-2.....	0	C403.01D1-1 to C403.01D1-2.....	0
M403.03-1 to M403.03-8.....	0	C403.01D2-1 to C403.01D2-2.....	0
M403.03A-1 to M403.03A-2.....	0	C403.01D3-1 to C403.01D3-2.....	0
M403.03B-1 to M403.03B-2.....	0	C403.01E-1 to C403.01E-6.....	0
M403.03C-1 to M403.03C-2.....	0	C403.01E1-1 to C403.01E1-2.....	0
M403.04-1 to M403.04-10.....	0	C403.01E2-1 to C403.01E2-2.....	0
M403.04A-1 to M403.04A-2.....	0	X04-1 to X04-2.....	0
M403.04B-1 to M403.04B-4.....	0	X05-1 to X05-2.....	0
M403.05-1 to M403.05-12.....	0	M406.01-1 to M406.01-6.....	0
M403.05A-1 to M403.05A-2.....	0	M406.01A-1 to M406.01A-2.....	0
M403.05B-1 to M403.05B-2.....	0	M406.01B-1 to M406.01B-2.....	0
M403.05C-1 to M403.05C-2.....	0	M406.01C-1 to M406.01C-2.....	0
M403.06-1 to M403.06-10.....	0	M406.01D-1 to M406.01D-2.....	0
M403.06A-1 to M403.06A-4.....	0	M406.01E-1 to M406.01E-2.....	0

LIST OF EFFECTIVE PAGES (Cont)

Page No.	Change No.	Page No.	Change No.
M406.01F-1 to M406.01F-2.....	0	M409.03-1 to M409.03-14.....	0
M406.01G-1 to M406.01G-2.....	0	M409.03A-1 to M409.03A-2.....	0
M406.01H-1 to M406.01H-2.....	0	M409.03B-1 to M409.03B-2.....	0
M406.01I-1 to M406.01I-2.....	0	M409.03C-1 to M409.03C-4.....	0
M406.01J-1 to M406.01J-2.....	0	M409.03D-1 to M409.03D-2.....	0
C406.01-1 to C406.01-8.....	0	M409.03E-1 to M409.03E-2.....	0
C406.01A-1 to C406.01A-4.....	0	M409.03F-1 to M409.03F-2.....	0
C406.02-1 to C406.02-10.....	0	M409.03G-1 to M409.03G-2.....	0
C406.02A-1 to C406.02A-2.....	0	M409.03H-1 to M409.03H-2.....	0
C406.02B-1 to C406.02B-2.....	0	M409.03I-1 to M409.03I-2.....	0
C406.02C-1 to C406.02C-2.....	0	M409.03J-1 to M409.03J-2.....	0
C406.02D-1 to C406.02D-2.....	0	M409.03K-1 to M409.03K-2.....	0
M407.01-1 to M407.01-14.....	0	M409.03L-1 to M409.03L-2.....	0
M407.01A-1 to M407.01A-6.....	0	M409.04-1 to M409.04-6.....	0
M407.02-1 to M407.02-10.....	0	M409.04A-1 to M409.04A-4.....	0
C407.01-1 to C407.01-10.....	0	M409.04B-1 to M409.04B-4.....	0
C407.01A-1 to C407.01A-2.....	0	M409.04C-1 to M409.04C-2.....	0
C407.01B-1 to C407.01B-2.....	0	M409.04D-1 to M409.04D-2.....	0
M408.01-1 to M408.01-6.....	0	M409.04E-1 to M409.04E-6.....	0
M408.02-1 to M408.02-10.....	0	M409.05-1 to M409.05-2.....	0
M408.03-1 to M408.03-12.....	0	C409.01-1 to C409.01-2.....	0
M408.03A-1 to M408.03A-2.....	0	C409.02-1 to C409.02-2.....	0
M408.04-1 to M408.04-6.....	0	C409.03-1 to C409.03-4.....	0
M408.04A-1 to M408.04A-2.....	0	C409.04-1 to C409.04-12.....	0
M408.04B-1 to M408.04B-4.....	0	C409.04A-1 to C409.04A-2.....	0
M408.04C-1 to M408.04C-2.....	0	C409.04B-1 to C409.04B-2.....	0
C408.01-1 to C408.01-8.....	0	C409.04C-1 to C409.04C-4.....	0
C408.01A-1 to C408.01A-2.....	0	C409.04D-1 to C409.04D-2.....	0
C408.02-1 to C408.02-2.....	0	C409.04E-1 to C409.04E-2.....	0
M409.01-1 to M409.01-10.....	0	C409.04F-1 to C409.04F-2.....	0
M409.01A-1 to M409.01A-2.....	0	C409.04G-1 to C409.04G-2.....	0
M409.01B-1 to M409.01B-2.....	0	C409.04H-1 to C409.04H-2.....	0
M409.01C-1 to M409.01C-8.....	0	C409.04I-1 to C409.04I-2.....	0
M409.01D-1 to M409.01D-6.....	0	C409.04J-1 to C409.04J-2.....	0
M409.01E-1 to M409.01E-6.....	0	C409.04K-1 to C409.04K-2.....	0
M409.01F-1 to M409.01F-2.....	0	C409.04L-1 to C409.04L-2.....	0
M409.01G-1 to M409.01G-2.....	0	C409.04M-1 to C409.04M-2.....	0
M409.01H-1 to M409.01H-2.....	0	C409.05-1 to C409.05-6.....	0
M409.02-1 to M409.02-16.....	0	C409.06-1 to C409.06-6.....	0
M409.02A-1 to M409.02A-4.....	0	C409.06A-1 to C409.06A-2.....	0
M409.02B-1 to M409.02B-2.....	0	X20-1 to X20-2.....	0
M409.02C-1 to M409.02C-2.....	0	C429.01-1 to C429.01-14.....	0

LIST OF EFFECTIVE PAGES (Cont)

Page No.	Change No.	Page No.	Change No.
C429.02-1 to C429.02-8.....	0	M436.02B-1 to M436.02B-2.....	0
C429.02A-1 to C429.02A-2.....	0	M436.02C-1 to M436.02C-2.....	0
C429.02B-1 to C429.02B-2.....	0	M436.02D-1 to M436.02D-2.....	0
C429.03-1 to C429.03-14.....	0	M436.02E-1 to M436.02E-2.....	0
C429.03A-1 to C429.03A-2.....	0	M436.02F-1 to M436.02F-2.....	0
C429.03B-1 to C429.03B-2.....	0	M436.02G-1 to M436.02G-2.....	0
C429.03C-1 to C429.03C-2.....	0	M436.02H-1 to M436.02H-4.....	0
C429.03D-1 to C429.03D-2.....	0	M436.02I-1 to M436.02I-2.....	0
C429.04-1 to C429.04-12.....	0	M436.02J-1 to M436.02J-6.....	0
M431.01-1 to M431.01-8.....	0	C436.01-1 to C436.01-6.....	0
M431.01A-1 to M431.01A-14.....	0	C436.01A-1 to C436.01A-4.....	0
M431.02-1 to M431.02-10.....	0	C436.02-1 to C436.02-12.....	0
M431.02A-1 to M431.02A-6.....	0	C436.02A-1 to C436.02A-8.....	0
M431.02B-1 to M431.02B-2.....	0	C436.03-1 to C436.03-22.....	0
M431.02C-1 to M431.02C-2.....	0	C436.03A-1 to C436.03A-2.....	0
C431.01-1 to C431.01-12.....	0	C436.03B-1 to C436.03B-2.....	0
C431.01A-1 to C431.01A-6.....	0	C436.03C-1 to C436.03C-2.....	0
C431.02-1 to C431.02-8.....	0	C436.03D-1 to C436.03D-2.....	0
C431.02A-1 to C431.02A-2.....	0	C436.03E-1 to C436.03E-2.....	0
C431.02B-1 to C431.02B-2.....	0	C436.03F-1 to C436.03F-2.....	0
C431.03-1 to C431.03-8.....	0	C436.03G-1 to C436.03G-2.....	0
M432.01-1 to M432.01-8.....	0	C436.03H-1 to C436.03H-4.....	0
M432.01A-1 to M432.01A-4.....	0	C436.03I-1 to C436.03I-2.....	0
M432.01B-1 to M432.01B-2.....	0	C436.03J-1 to C436.03J-2.....	0
M432.02-1 to M432.02-6.....	0	M437.01-1 to M437.01-12.....	0
M432.02A-1 to M432.02A-2.....	0	M437.01A-1 to M437.01A-2.....	0
M432.03-1 to M432.03-6.....	0	M437.01B-1 to M437.01B-4.....	0
M432.03A-1 to M432.03A-2.....	0	M437.01C-1 to M437.01C-2.....	0
M432.03B-1 to M432.03B-2.....	0	M437.02-1 to M437.02-6.....	0
M432.03C-1 to M432.03C-2.....	0	M437.02A-1 to M437.02A-2.....	0
C432.01-1 to C432.01-6.....	0	M437.02B-1 to M437.02B-2.....	0
C432.01A-1 to C432.01A-2.....	0	M437.02C-1 to M437.02C-2.....	0
C432.02-1 to C432.02-6.....	0	C437.01-1 to C437.01-10.....	0
C432.02A-1 to C432.02A-2.....	0	C437.01A-1 to C437.01A-2.....	0
C432.02B-1 to C432.02B-2.....	0	C437.01B-1 to C437.01B-2.....	0
C432.02C-1 to C432.02C-2.....	0	C437.01C-1 to C437.01C-2.....	0
C432.03-1 to C432.03-6.....	0	C437.02-1 to C437.02-12.....	0
C432.03A-1 to C432.03A-2.....	0	M440.01-1 to M440.01-8.....	0
M436.01-1 to M436.01-10.....	0	M440.01A-1 to M440.01A-4.....	0
M436.01A-1 to M436.01A-6.....	0	M440.01B-1 to M440.01B-4.....	0
M436.02-1 to M436.02-10.....	0	M440.02-1 to M440.02-10.....	0
M436.02A-1 to M436.02A-4.....	0	M440.02A-1 to M440.02A-2.....	0

LIST OF EFFECTIVE PAGES (Cont)

Page No.	Change No.	Page No.	Change No.
M440.02B-1 to M440.02B-6.....	0	C440.11A-1 to C440.11A-2.....	0
M440.02C-1 to M440.02C-4.....	0	C440.11B-1 to C440.11B-6.....	0
C440.01-1 to C440.01-10.....	0	C440.11C-1 to C440.11C-6.....	0
C440.01A-1 to C440.01A-12.....	0	C460.01-1 to C460.01-6.....	0
C440.01B-1 to C440.01B-2.....	0	C460.02-1 to C460.02-8.....	0
C440.01C-1 to C440.01C-2.....	0	C460.03-1 to C460.03-6.....	0
C440.02-1 to C440.02-6.....	0	C470.01-1 to C470.01-6.....	0
C440.02A-1 to C440.02A-2.....	0	C470.01A-1 to C470.01A-2.....	0
C440.02B-1 to C440.02B-2.....	0	C470.01B-1 to C470.01B-2.....	0
C440.02C-1 to C440.02C-2.....	0	C470.01C-1 to C470.01C-2.....	0
C440.03-1 to C440.03-10.....	0	C470.02-1 to C470.02-6.....	0
C440.03A-1 to C440.03A-2.....	0	C470.02A-1 to C470.02A-6.....	0
C440.03B-1 to C440.03B-2.....	0	C470.02B-1 to C470.02B-6.....	0
C440.04-1 to C440.04-10.....	0	C470.03-1 to C470.03-4.....	0
C440.04A-1 to C440.04A-6.....	0	C470.03A-1 to C470.03A-2.....	0
C440.04B-1 to C440.04B-2.....	0	C470.03B-1 to C470.03B-2.....	0
C440.04C-1 to C440.04C-2.....	0	C470.03C-1 to C470.03C-4.....	0
C440.05-1 to C440.05-12.....	0	C470.03D-1 to C470.03D-2.....	0
C440.05A-1 to C440.05A-2.....	0	C470.03E-1 to C470.03E-2.....	0
C440.05B-1 to C440.05B-6.....	0	C470.03F-1 to C470.03F-2.....	0
C440.05C-1 to C440.05C-4.....	0	C470.03G-1 to C470.03G-2.....	0
C440.06-1 to C440.06-10.....	0	M490.01-1 to M490.01-8.....	0
C440.06A-1 to C440.06A-2.....	0	M490.02-1 to M490.02-20.....	0
C440.06B-1 to C440.06B-2.....	0	M490.03-1 to M490.03-28.....	0
C440.06C-1 to C440.06C-2.....	0	M490.03A-1 to M490.03A-4.....	0
C440.07-1 to C440.07-8.....	0	M490.03B-1 to M490.03B-6.....	0
C440.07A-1 to C440.07A-2.....	0	M490.04-1 to M490.04-6.....	0
C440.07B-1 to C440.07B-2.....	0	M490.04A-1 to M490.04A-2.....	0
C440.08-1 to C440.08-8.....	0	M490.04B-1 to M490.04B-2.....	0
C440.08A-1 to C440.08A-2.....	0	M490.05-1 to M490.05-26.....	0
C440.08B-1 to C440.08B-2.....	0	C490.01-1 to C490.01-8.....	0
C440.08C-1 to C440.08C-2.....	0	C490.02-1 to C490.02-12.....	0
C440.09-1 to C440.09-10.....	0	C490.03-1 to C490.03-26.....	0
C440.09A-1 to C440.09A-2.....	0	C490.03A-1 to C490.03A-2.....	0
C440.09B-1 to C440.09B-2.....	0	C490.04-1 to C490.04-16.....	0
C440.09C-1 to C440.09C-2.....	0	C490.05-1 to C490.05-34.....	0
C440.10-1 to C440.10-6.....	0	C490.06-1 to C490.06-24.....	0
C440.10A-1 to C440.10A-2.....	0	C490.06A-1 to C490.06A-2.....	0
C440.11-1 to C440.11-6.....	0		

Contact Officer: D Cdts & JCR 4-7-4 – Air Cadet Program Development Staff Officer

© 2015 DND/MDN Canada

THIS PAGE INTENTIONALLY LEFT BLANK

FOREWORD AND PREFACE

1. **Issuing Authority.** This Instructional Guide (IG) A-CR-CCP-804/PF-001 was developed under the authority of the Director Cadets and Junior Canadian Rangers, and issued on the authority of the Chief of Defence Staff.
2. **Development.** Development of this IG was in accordance with the performance oriented concept of training outlined in the A-P9-050 Series, *Canadian Forces Individual Training and Education System*, with modifications to meet the needs of the Canadian Cadet Organization.
3. **Purpose of the IG.** The IG is to be used by Royal Canadian Air Cadet Squadrons in conjunction with other resources to conduct the Proficiency Level Four Program. The IG provides instructors with the base means from which to deliver training. Individual IGs are to be reviewed in conjunction with the Lesson Specifications (LSs) found in Chapter 4 of A-CR-CCP-804/PG-001, *Royal Canadian Air Cadet Proficiency Level Four Qualification Standard and Plan*, before instructing, so that each instructor can adequately plan for and prepare each lesson. Instructors may be required to develop instructional materials to support training in addition to any that may be provided, eg, posters, videos, handouts, models, etc, supplemental to training control and support documents. Suggested instructional activities are included in most IGs to maximize learning and fun. Instructors are also encouraged to modify and / or enhance the activities, as long as they continue to contribute to enabling objective achievement.
4. **Use of the IG.** Throughout these instructional guides, a series of information boxes are used to highlight information; they include:



Note to the Instructor.



Key information to pass along to cadets.



Refer to the following CF regulations and policies.



Points of interest or special instructions the instructor should pass along to cadets.

5. **Suggested Changes.** Suggested changes to this document may be sent directly to cadettraining@canada.ca.

THIS PAGE INTENTIONALLY LEFT BLANK

TABLE OF CONTENTS

		PAGE
CHAPTER 1	PO 400 – PARTICIPATE IN POSITIVE SOCIAL RELATIONS FOR YOUTH TRAINING	
	PO 400 – PARTICIPATE IN POSITIVE SOCIAL RELATIONS FOR YOUTH TRAINING.....	400-1
CHAPTER 2	PO X01 – PARTICIPATE IN CITIZENSHIP ACTIVITIES	
	PO X01 – PARTICIPATE IN CITIZENSHIP ACTIVITIES	X01-1
CHAPTER 3	PO X02 – PERFORM COMMUNITY SERVICE	
	PO X02 – PERFORM COMMUNITY SERVICE	X02-1
CHAPTER 4	PO 403 – ACT AS A TEAM LEADER	
Section 1	EO M403.01 – DESCRIBE NEEDS AND EXPECTATIONS OF TEAM MEMBERS.....	M403.01-1
Attachment A	NEEDS AND EXPECTATIONS OF TEAM MEMBERS	M403.01A-1
Section 2	EO M403.02 – SELECT A LEADERSHIP APPROACH.....	M403.02-1
Attachment A	OUTCOMES AS A RESULT OF THE TEAM LEADER’S FOCUS	M403.02A-1
Attachment B	M403.02B-1
Attachment C	SCENARIOS	M403.02C-1
Attachment D	TRANSACTIONAL AND TRANSFORMATIONAL LEADERSHIP	M403.02D-1
Section 3	EO M403.03 – MOTIVATE TEAM MEMBERS.....	M403.03-1
Attachment A	EXTRINSIC MOTIVATORS	M403.03A-1
Attachment B	INTRINSIC MOTIVATORS	M403.03B-1
Attachment C	WHEN TEAM LEADERS MOTIVATE TEAM MEMBERS	M403.03C-1
Section 4	EO M403.04 – PROVIDE FEEDBACK TO TEAM MEMBERS.....	M403.04-1
Attachment A	SCENARIOS FOR PROVIDING FEEDBACK	M403.04A-1
Attachment B	EFFECTIVE FEEDBACK	M403.04B-1
Section 5	EO M403.05 – PARTICIPATE IN A MENTORING RELATIONSHIP....	M403.05-1
Attachment A	SCENARIO FOR THE MENTORING DEMONSTRATION	M403.05A-1
Attachment B	SCENARIO 1 FOR THE ROLE-PLAY ACTIVITY	M403.05B-1
Attachment C	SCENARIO 2 FOR THE ROLE-PLAY ACTIVITY	M403.05C-1
Section 6	EO M403.06 – ACT AS A TEAM LEADER DURING A LEADERSHIP APPOINTMENT.....	M403.06-1
Attachment A	POSSIBLE YEAR FOUR LEADERSHIP ASSIGNMENTS	M403.06A-1
Attachment B	LEADERSHIP APPOINTMENT AIDE-MEMOIRE	M403.06B-1
Section 7	EO C403.01 – PARTICIPATE IN A LEADERSHIP SEMINAR.....	C403.01-1
Attachment A	SEMINAR INFORMATION	C403.01A-1
Attachment B	LEADERSHIP SEMINAR PROBLEM SOLVING	C403.01B-1
Appendix 1	C403.01B1-1
Appendix 2	NASA SURVIVAL ON THE MOON TEAM ANSWER SHEET	C403.01B2-1

TABLE OF CONTENTS (Cont)

		PAGE
Appendix 3	ANSWERS TO THE SURVIVAL ON THE MOON	C403.01B3-1
Appendix 4	STEPLADDER OR SIX THINKING HATS SCENARIO	C403.01B4-1
Appendix 5	PROBLEMS TO SOLVE	C403.01B5-1
Appendix 6	ANSWER KEY TO PROBLEMS	C403.01B6-1
Attachment C	LEADERSHIP SEMINAR TIME MANAGEMENT	C403.01C-1
Appendix 1	SCENARIO FOR CREATING A TO-DO LIST	C403.01C1-1
Attachment D	LEADERSHIP SEMINAR COMMUNICATIONS	C403.01D-1
Appendix 1	C403.01D1-1
Appendix 2	SCENARIO FOR ROLE-PLAY	C403.01D2-1
Appendix 3	READING BODY LANGUAGE	C403.01D3-1
Attachment E	LEADERSHIP SEMINAR SUPERVISION	C403.01E-1
Appendix 1	C403.01E1-1
Appendix 2	SCENARIO FOR SUPERVISION PLAN	C403.01E2-1
CHAPTER 5	PO X04 – TRACK PARTICIPATION IN PHYSICAL ACTIVITIES	
	PO X04 – TRACK PARTICIPATION IN PHYSICAL ACTIVITIES.....	X04-1
CHAPTER 6	PO X05 – PARTICIPATE IN PHYSICAL ACTIVITIES	
	PO X05 – PARTICIPATE IN PHYSICAL ACTIVITIES	X05-1
CHAPTER 7	PO 406 – FIRE THE CADET AIR RIFLE DURING RECREATIONAL MARKSMANSHIP	
Section 1	EO M406.01 – PARTICIPATE IN A RECREATIONAL MARKSMANSHIP ACTIVITY.....	M406.01-1
Attachment A	CLASSIFICATION ACTIVITY	M406.01A-1
Attachment B	FUN ACTIVITIES	M406.01B-1
Attachment C	FUN ACTIVITIES	M406.01C-1
Attachment D	FUN ACTIVITIES	M406.01D-1
Attachment E	FUN ACTIVITIES	M406.01E-1
Attachment F	TIMED ACTIVITIES	M406.01F-1
Attachment G	TIMED ACTIVITIES	M406.01G-1
Attachment H	TIMED ACTIVITIES	M406.01H-1
Attachment I	COMPETITIVE ACTIVITIES	M406.01I-1
Attachment J	COMPETITIVE ACTIVITIES	M406.01J-1
Section 2	EO C406.01 – ASSIST THE RANGE SAFETY OFFICER (RSO).....	C406.01-1
Attachment A	WAYS TO ASSIST THE RSO	C406.01A-1
Section 3	EO C406.02 – SCORE AIR RIFLE MARKSMANSHIP TARGETS.....	C406.02-1
Attachment A	SAMPLE GROUPING TARGET	C406.02A-1
Attachment B	AIR RIFLE GROUPING TEMPLATE	C406.02B-1
Attachment C	SAMPLE COMPETITION TARGET	C406.02C-1

TABLE OF CONTENTS (Cont)

		PAGE
Attachment D	SCORING TEMPLATE	C406.02D-1
CHAPTER 8	PO 407 – SERVE IN AN AIR CADET SQUADRON	
Section 1	EO M407.01 – DISCUSS PROFICIENCY LEVEL FOUR TRAINING OPPORTUNITIES.....	M407.01-1
Attachment A	M407.01A-1
Section 2	EO M407.02 – DISCUSS YEAR FOUR CADET SUMMER TRAINING CENTRE (CSTC) TRAINING OPPORTUNITIES.....	M407.02-1
Section 3	EO C407.01 – PREPARE FOR A MERIT REVIEW BOARD.....	C407.01-1
Attachment A	EXAMPLE QUESTIONS TO EXPECT AT A MERIT REVIEW BOARD FOR PROMOTION	C407.01A-1
Attachment B	PREPARATION FOR A MERIT REVIEW BOARD FOR PROMOTION	C407.01B-1
CHAPTER 9	PO 408 – COMMAND A FLIGHT ON PARADE	
Section 1	EO M408.01 – DISCUSS COMMANDING A FLIGHT ON PARADE....	M408.01-1
Section 2	EO M408.02 – IDENTIFY PARADE SEQUENCE.....	M408.02-1
Section 3	EO M408.03 – COMMAND A SQUAD.....	M408.03-1
Attachment A	PARADE SEQUENCE AIDE-MÉMOIRE CARD	M408.03A-1
Section 4	EO M408.04 – INSPECT A CADET ON PARADE.....	M408.04-1
Attachment A	DRESS INSTRUCTIONS ACTIVITY WORKSHEET	M408.04A-1
Attachment B	DRESS INSTRUCTIONS ACTIVITY WORKSHEET ANSWER SHEET	M408.04B-1
Attachment C	DRESS INSTRUCTIONS CHECKLIST	M408.04C-1
Section 5	EO C408.01 – DISCUSS THE HISTORY OF DRILL.....	C408.01-1
Attachment A	SUMMARY OF SIGNIFICANT DRILL EVENTS	C408.01A-1
Section 6	EO C408.02 – VIEW A RE-ENACTMENT THAT DEMONSTRATES THE HISTORY OF DRILL.....	C408.02-1
CHAPTER 10	PO 409 – INSTRUCT A LESSON	
Section 1	EO M409.01 – IDENTIFY METHODS OF INSTRUCTION.....	M409.01-1
Attachment A	M409.01A-1
Attachment B	M409.01B-1
Attachment C	METHODS OF INSTRUCTION PUZZLE	M409.01C-1
Attachment D	M409.01D-1
Attachment E	M409.01E-1
Attachment F	M409.01F-1
Attachment G	METHOD MADNESS	M409.01G-1
Attachment H	METHODS OF INSTRUCTION SUMMARY	M409.01H-1
Section 2	EO M409.02 – IDENTIFY ELEMENTS OF A POSITIVE LEARNING ENVIRONMENT.....	M409.02-1

TABLE OF CONTENTS (Cont)

	PAGE
Attachment A RELAXATION EXERCISES	M409.02A-1
Attachment B CREATE A POSITIVE LEARNING ENVIRONMENT CROSSWORD PUZZLE	M409.02B-1
Attachment C CREATE A POSITIVE LEARNING ENVIRONMENT ANSWER KEY .	M409.02C-1
Section 3 EO M409.03 – DESCRIBE LEARNER NEEDS.....	M409.03-1
Attachment A TIGER COMIC	M409.03A-1
Attachment B LEARNING PYRAMID	M409.03B-1
Attachment C DEVELOPMENTAL PERIODS CONFIRMATION	M409.03C-1
Attachment D LEARNING STYLES INFORMATION SHEET	M409.03D-1
Attachment E LEARNING STYLES SURVEY	M409.03E-1
Attachment F HOW TO MAKE A JUMPING FROG	M409.03F-1
Attachment G HOW TO MAKE A TRIANGULAR BOX	M409.03G-1
Attachment H	M409.03H-1
Attachment I INSTRUCTOR TIPS FOR LEARNING STYLES	M409.03I-1
Attachment J INSTRUCTOR TIPS FOR LEARNING STYLES ANSWER KEY	M409.03J-1
Attachment K ACTIVITIES IN DEVELOPMENTAL PERIODS	M409.03K-1
Attachment L ACTIVITIES IN DEVELOPMENTAL PERIODS ANSWER KEY	M409.03L-1
Section 4 EO M409.04 – EXPLAIN ASSESSMENT.....	M409.04-1
Attachment A ASSESSMENT OF LEARNING PLAN – PROFICIENCY LEVEL THREE	M409.04A-1
Attachment B 303 PC ASSESSMENT INSTRUCTIONS.....	M409.04B-1
Attachment C 303 PC ASSESSMENT RUBRIC	M409.04C-1
Attachment D 308 PC ASSESSMENT CHECKLIST	M409.04D-1
Attachment E 390 PC ASSESSMENT CHECKLIST	M409.04E-1
Section 5 EO M409.05 – INSTRUCT A 30-MINUTE LESSON.....	M409.05-1
Section 6 EO C409.01 – PLAN A LESSON.....	C409.01-1
Section 7 EO C409.02 – INSTRUCT A 30-MINUTE LESSON.....	C409.02-1
Section 8 EO C409.03 – ACT AS AN ASSISTANT INSTRUCTOR.....	C409.03-1
Section 9 EO C409.04 – PARTICIPATE IN A CREATIVE LESSON-PLANNING WORKSHOP.....	C409.04-1
Attachment A MIXER	C409.04A-1
Attachment B PICTURE THIS...	C409.04B-1
Attachment C CLICHE STRECTCHING	C409.04C-1
Attachment D MIXER ANSWER KEY	C409.04D-1
Attachment E	C409.04E-1
Attachment F THE BENEFITS OF CREATIVE LESSONS	C409.04F-1
Attachment G	C409.04G-1
Attachment H	C409.04H-1
Attachment I BENEFITS OF CREATIVE LESSONS PHRASE STRIPS	C409.04I-1

TABLE OF CONTENTS (Cont)

		PAGE
Attachment J	THE CREATIVE PROCESS	C409.04J-1
Attachment K	C409.04K-1
Attachment L	C409.04L-1
Attachment M	WAYS TO INCORPORATE CREATIVITY	C409.04M-1
Section 10	EO C409.05 – ACT AS AN ASSISTANT DRILL INSTRUCTOR.....	C409.05-1
Section 11	EO C409.06 – INSTRUCT A 30-MINUTE DRILL LESSON.....	C409.06-1
Attachment A	DRILL INSTRUCTIONAL TECHNIQUES	C409.06A-1
CHAPTER 11	PO X20 – PARTICIPATE IN CAF FAMILIARIZATION	
	PO X20 – PARTICIPATE IN CAF FAMILIARIZATION.....	X20-1
CHAPTER 12	PO 429 – COMMUNICATE USING RADIO PROCEDURES FOR AVIATION TRANSMISSION	
Section 1	EO C429.01 – EXPLAIN REGULATIONS AND OPERATING PROCEDURES FOR AVIATION TRANSMISSION AND LICENSING.	C429.01-1
Section 2	EO C429.02 – COMMUNICATE USING RADIO PROCEDURES FOR AVIATION TRANSMISSION.....	C429.02-1
Attachment A	PROCEDURAL WORDS AND PHRASES	C429.02A-1
Attachment B	C429.02B-1
Section 3	EO C429.03 – DESCRIBE RADIO WAVELENGTHS, SIGNALS, LICENCES AND EQUIPMENT.....	C429.03-1
Attachment A	C429.03A-1
Attachment B	C429.03B-1
Attachment C	C429.03C-1
Attachment D	C429.03D-1
Section 4	EO C429.04 – EXPLAIN EMERGENCY, URGENCY AND SAFETY COMMUNICATIONS.....	C429.04-1
CHAPTER 13	PO 431 – EXPLAIN PRINCIPLES OF FLIGHT	
Section 1	EO M431.01 – EXPLAIN FEATURES OF WING DESIGN.....	M431.01-1
Attachment A	M431.01A-1
Section 2	EO M431.02 – DESCRIBE FLIGHT INSTRUMENTS.....	M431.02-1
Attachment A	M431.02A-1
Attachment B	SAMPLE QUESTIONS	M431.02B-1
Attachment C	INSTRUCTIONS FOR CREATION OF PITOT STATIC INSTRUCTIONAL AIDS	M431.02C-1
Section 3	EO C431.01 – EXPLAIN FLIGHT PERFORMANCE FACTORS.....	C431.01-1
Attachment A	C431.01A-1
Section 4	EO C431.02 – DEMONSTRATE TURNS, CLIMBS AND DESCENTS IN A FLIGHT SIMULATOR.....	C431.02-1
Attachment A	C431.02A-1

TABLE OF CONTENTS (Cont)

		PAGE
Attachment B	CLIMBS, TURNS AND DESCENTS HANDOUT	C431.02B-1
Section 5	EO C431.03 – FLY A RADIO-CONTROLLED AIRCRAFT.....	C431.03-1
CHAPTER 14	PO 432 – DESCRIBE AERO ENGINE SYSTEMS	
Section 1	EO M432.01 – DESCRIBE FUEL SYSTEMS.....	M432.01-1
Attachment A	M432.01A-1
Attachment B	CARBURETOR STUDY HANDOUT	M432.01B-1
Section 2	EO M432.02 – DESCRIBE PROPELLER SYSTEMS.....	M432.02-1
Attachment A	M432.02A-1
Section 3	EO M432.03 – DESCRIBE ENGINE INSTRUMENTS.....	M432.03-1
Attachment A	M432.03A-1
Attachment B	AERO ENGINES REVIEW WORKSHEET	M432.03B-1
Attachment C	AERO ENGINES REVIEW WORKSHEET ANSWER KEY	M432.03C-1
Section 4	EO C432.01 – DESCRIBE IGNITION AND ELECTRICAL SYSTEMS.	C432.01-1
Attachment A	C432.01A-1
Section 5	EO C432.02 – DESCRIBE TURBOCHARGING AND SUPERCHARGING SYSTEMS.....	C432.02-1
Attachment A	C432.02A-1
Attachment B	TURBOCHARGING AND SUPERCHARGING WORKSHEET	C432.02B-1
Attachment C	TURBOCHARGING AND SUPERCHARGING WORKSHEET ANSWER KEY	C432.02C-1
Section 6	EO C432.03 – DESCRIBE GAS TURBINE ENGINES.....	C432.03-1
Attachment A	C432.03A-1
CHAPTER 15	PO 436 – EXPLAIN ASPECTS OF METEOROLOGY	
Section 1	EO M436.01 – EXPLAIN WINDS.....	M436.01-1
Attachment A	M436.01A-1
Section 2	EO M436.02 – DESCRIBE AIR MASSES AND FRONTS.....	M436.02-1
Attachment A	WARM AND COLD FRONT DEMONSTRATION OUTLINE	M436.02A-1
Attachment B	M436.02B-1
Attachment C	M436.02C-1
Attachment D	WEATHER MAP SYMBOLS	M436.02D-1
Attachment E	COLD FRONT	M436.02E-1
Attachment F	WARM FRONT	M436.02F-1
Attachment G	STATIONARY FRONT	M436.02G-1
Attachment H	OCCLUDED FRONTS	M436.02H-1
Attachment I	UPPER FRONTS	M436.02I-1
Attachment J	M436.02J-1
Section 3	EO C436.01 – EXPLAIN FOG.....	C436.01-1
Attachment A	C436.01A-1

TABLE OF CONTENTS (Cont)

		PAGE
Section 4	EO C436.02 – DESCRIBE SEVERE WEATHER CONDITONS.....	C436.02-1
Attachment A	C436.02A-1
Section 5	EO C436.03 – ANALYZE WEATHER INFORMATION.....	C436.03-1
Attachment A	SAMPLE METARS AND SPECIS	C436.03A-1
Attachment B	WORLD METEOROLOGICAL ORGANIZATION CODE FOR PRESENT WEATHER	C436.03B-1
Attachment C	SAMPLE TAFS	C436.03C-1
Attachment D	SAMPLE FDS	C436.03D-1
Attachment E	DECODING FDS	C436.03E-1
Attachment F	C436.03F-1
Attachment G	C436.03G-1
Attachment H	C436.03H-1
Attachment I	GFA WEATHER SYMBOLS	C436.03I-1
Attachment J	C436.03J-1
CHAPTER 16	PO 437 – EXPLAIN ASPECTS OF AIR NAVIGATION	
Section 1	EO M437.01 – DEFINE AIR NAVIGATION TERMS.....	M437.01-1
Attachment A	M437.01A-1
Attachment B	M437.01B-1
Attachment C	HEADINGS AND BEARINGS WORKSHEET	M437.01C-1
Section 2	EO M437.02 – DESCRIBE THE MAGNETIC COMPASS.....	M437.02-1
Attachment A	M437.02A-1
Attachment B	MAGNETIC HEADINGS WORKSHEET	M437.02B-1
Attachment C	MAGNETIC HEADINGS ANSWER KEY	M437.02C-1
Section 3	EO C437.01 – SOLVE NAVIGATION PROBLEMS WITH A MANUAL FLIGHT COMPUTER.....	C437.01-1
Attachment A	C437.01A-1
Attachment B	NAVIGATION PROBLEMS WORKSHEET	C437.01B-1
Attachment C	NAVIGATION PROBLEMS ANSWER KEY	C437.01C-1
Section 4	EO C437.02 – USE A VISUAL FLIGHT RULES (VFR) NAVIGATION CHART (VNC).....	C437.02-1
CHAPTER 17	PO 440 – DISCUSS AEROSPACE STRUCTURES	
Section 1	EO M440.01 – IDENTIFY AEROSPACE MATERIALS.....	M440.01-1
Attachment A	M440.01A-1
Attachment B	M440.01B-1
Section 2	EO M440.02 – DESCRIBE CANADIAN SATELLITES.....	M440.02-1
Attachment A	M440.02A-1
Attachment B	M440.02B-1
Attachment C	M440.02C-1

TABLE OF CONTENTS (Cont)

		PAGE
Section 3	EO C440.01 – DESCRIBE MODEL ROCKETRY.....	C440.01-1
Attachment A	C440.01A-1
Attachment B	CANADIAN ASSOCIATION OF ROCKETRY: CANADA MODEL ROCKET SAFETY CODE	C440.01B-1
Attachment C	C440.01C-1
Section 4	EO C440.02 – LAUNCH A SMALL MODEL ROCKET.....	C440.02-1
Attachment A	LAUNCH SITE SET-UP	C440.02A-1
Attachment B	MODEL ROCKET LAUNCH PROCEDURE	C440.02B-1
Attachment C	IF THE ROCKET ENGINE DOES NOT IGNITE	C440.02C-1
Section 5	EO C440.03 – DISCUSS CHARACTERISTICS OF THE PLANETS IN THE SOLAR SYSTEM.....	C440.03-1
Attachment A	PLANET SPECIFICATIONS SHEET	C440.03A-1
Attachment B	PLANET SPECIFICATIONS ANSWER KEY	C440.03B-1
Section 6	EO C440.04 – APPLY THE MATERIAL SCIENCE OF TRUSSES.....	C440.04-1
Attachment A	C440.04A-1
Attachment B	C440.04B-1
Attachment C	C440.04C-1
Section 7	EO C440.05 – DESCRIBE ROBOTICS.....	C440.05-1
Attachment A	C440.05A-1
Attachment B	C440.05B-1
Attachment C	C440.05C-1
Section 8	EO C440.06 – USE STAR CHARTS.....	C440.06-1
Attachment A	C440.06A-1
Attachment B	C440.06B-1
Attachment C	C440.06C-1
Section 9	EO C440.07 – OPERATE A TELESCOPE.....	C440.07-1
Attachment A	C440.07A-1
Attachment B	C440.07B-1
Section 10	EO C440.08 – WATCH <i>BLAST!</i> (<i>BALLOON-BORNE LARGE APERTURE SUB-MILLIMETRE TELESCOPE</i>).....	C440.08-1
Attachment A	C440.08A-1
Attachment B	C440.08B-1
Attachment C	QUESTIONS TO CONSIDER WHILE WATCHING <i>BLAST!</i>	C440.08C-1
Section 11	EO C440.09 – DESCRIBE THE RELATIONSHIP BETWEEN GRAVITY AND SPACE-TIME.....	C440.09-1
Attachment A	C440.09A-1
Attachment B	GRAVITY, SPACE-TIME AND GP-B	C440.09B-1
Attachment C	ANSWER KEY—GRAVITY, SPACE-TIME AND GP-B	C440.09C-1
Section 12	EO C440.10 – DISCUSS KINETIC AND POTENTIAL ENERGY.....	C440.10-1

TABLE OF CONTENTS (Cont)

		PAGE
Attachment A	C440.10A-1
Section 13	EO C440.11 – WATCH <i>EINSTEIN'S BIG IDEA</i>	C440.11-1
Attachment A	C440.11A-1
Attachment B	C440.11B-1
Attachment C	C440.11C-1
CHAPTER 18	PO 460 – DESCRIBE AERODROME OPERATIONS CAREER OPPORTUNITIES	
Section 1	EO C460.01 – DESCRIBE AERODROME OPERATIONS CAREER OPPORTUNITIES.....	C460.01-1
Section 2	EO C460.02 – DESCRIBE AIR TRAFFIC CONTROL (ATC) CAREER OPPORTUNITIES.....	C460.02-1
Section 3	EO C460.03 – DESCRIBE AIRPORT SECURITY CAREER OPPORTUNITIES.....	C460.03-1
CHAPTER 19	PO 470 – DISCUSS ASPECTS OF AIRCRAFT MANUFACTURING AND MAINTENANCE	
Section 1	EO C470.01 – DISCUSS AIRCRAFT MANUFACTURERS.....	C470.01-1
Attachment A	INTERNATIONAL PARTNERSHIPS	C470.01A-1
Attachment B	INTERNATIONAL PARTNERSHIP SUMMARY SHEET	C470.01B-1
Attachment C	UNMANNED AERIAL VEHICLE (UAV) MANUFACTURERS WORKSHEET	C470.01C-1
Section 2	EO C470.02 – DISCUSS AIRCRAFT ASSEMBLY.....	C470.02-1
Attachment A	C470.02A-1
Attachment B	C470.02B-1
Section 3	EO C470.03 – IDENTIFY AVIATION HARDWARE.....	C470.03-1
Attachment A	AVIATION HARDWARE HANDOUT	C470.03A-1
Attachment B	BOLTS	C470.03B-1
Attachment C	RIVETS	C470.03C-1
Attachment D	SCREWS	C470.03D-1
Attachment E	TURNLOCK FASTENERS	C470.03E-1
Attachment F	AVIATION HARDWARE IDENTIFICATION WORKSHEET	C470.03F-1
Attachment G	AVIATION HARDWARE IDENTIFICATION WORKSHEET ANSWER KEY	C470.03G-1
CHAPTER 20	PO 490 – PARTICIPATE IN AN AIRCREW SURVIVAL EXERCISE	
Section 1	EO M490.01 – ASSEMBLE AN EMERGENCY SURVIVAL KIT.....	M490.01-1
Section 2	EO M490.02 – OPERATE A STOVE AND A LANTERN.....	M490.02-1
Section 3	EO M490.03 – TIE KNOTS AND LASHINGS.....	M490.03-1
Attachment A	KNOT-TYING INSTRUCTIONS	M490.03A-1
Attachment B	LASHING INSTRUCTIONS	M490.03B-1

TABLE OF CONTENTS (Cont)

		PAGE
Section 4	EO M490.04 – NAVIGATE TO A WAYPOINT USING A GLOBAL POSITIONING SYSTEM (GPS) RECEIVER.....	M490.04-1
Attachment A	WAYPOINT FORM	M490.04A-1
Attachment B	EXAMPLE OF COMPLETED WAYPOINT FORM	M490.04B-1
Section 5	EO M490.05 – LIGHT FIRES USING IMPROVISED IGNITION.....	M490.05-1
Section 6	EO C490.01 – DESCRIBE CLIMATIC AND SEASONAL CONCERNS.....	C490.01-1
Section 7	EO C490.02 – IMPROVISE TOOLS FOR USE IN A SURVIVAL SITUATION.....	C490.02-1
Section 8	EO C490.03 – MOVE A CASUALTY TO SHELTER.....	C490.03-1
Attachment A	EMERGENCY SCENE MANAGEMENT SCENARIOS	C490.03A-1
Section 9	EO C490.04 – PRACTICE SAFE TOOLCRAFT.....	C490.04-1
Section 10	EO C490.05 – NAVIGATE A ROUTE USING A MAP AND COMPASS.....	C490.05-1
Section 11	EO C490.06 – ERECT, TEAR DOWN AND PACK TENTS.....	C490.06-1
Attachment A	C490.06A-1



**COMMON TRAINING
PROFICIENCY LEVEL FOUR
INSTRUCTIONAL GUIDE
POSITIVE SOCIAL RELATIONS FOR YOUTH**



SECTION 1

PO 400 – PARTICIPATE IN POSITIVE SOCIAL RELATIONS FOR YOUTH TRAINING

Total Time:

The instructional guides for this PO are located in A-CR-CCP-915/PG-001, Positive Social Relations for Youth Training Facilitator's Package.

THIS PAGE INTENTIONALLY LEFT BLANK



**COMMON TRAINING
ALL TRAINING LEVELS
INSTRUCTIONAL GUIDE
CITIZENSHIP**



POSITIVE SOCIAL RELATIONS FOR YOUTH

SECTION 1

PO X01 – PARTICIPATE IN CITIZENSHIP ACTIVITIES

Total Time:

For the following EOs, refer to the lesson specifications located in A-CR-CCP-701/PG-001, *Royal Canadian Army Cadets Green Star Qualification Standard and Plan*:

- MX01.01A – Participate in a Citizenship Tour,
- MX01.01B – Attend a Presentation by a Community Organization,
- MX01.01C – Attend a Presentation by a Citizen-of-Interest,
- MX01.01D – Participate in the Canadian Citizenship Challenge,
- MX01.01E – Host a Citizenship Ceremony, and
- CX01.01 – Participate in Citizenship Activities.

For the following EOs, refer to the instructional guides located in A-CR-CCP-701/PF-001, *Canadian Army Cadets Green Star Instructional Guides*:

- MX01.01F – Participate in an Election,
- MX01.01G – Participate in Heritage Minutes Video Activities, and
- MX01.01H – Participate in Citizenship Learning Stations.

THIS PAGE INTENTIONALLY LEFT BLANK



**COMMON TRAINING
ALL TRAINING LEVELS
INSTRUCTIONAL GUIDE
COMMUNITY SERVICE**



SECTION 1

PO X02 – PERFORM COMMUNITY SERVICE

Total Time:

For the following EOs, refer to the instructional guides located in A-CR-CCP-801/PF-001, *Royal Canadian Air Cadets Proficiency Level One Instructional Guides*:

- MX02.01 – Perform Community Service, and
- CX02.01 – Perform Community Service.

THIS PAGE INTENTIONALLY LEFT BLANK



**COMMON TRAINING
PROFICIENCY LEVEL FOUR
INSTRUCTIONAL GUIDE**



SECTION 1

EO M403.01 – DESCRIBE NEEDS AND EXPECTATIONS OF TEAM MEMBERS

Total Time:

30 min

PREPARATION

PRE-LESSON INSTRUCTIONS

Resources needed for the delivery of this lesson are listed in the lesson specification located in A-CR-CCP-804/PG-001, *Proficiency Level Four Qualification Standard and Plan*, Chapter 4. Specific uses for said resources are identified throughout the instructional guide within the TP for which they are required.

Review the lesson content and become familiar with the material prior to delivering the lesson.

Photocopy the Needs and Expectations of Team Members handout located at Attachment A for each cadet.

PRE-LESSON ASSIGNMENT

Nil.

APPROACH

An interactive lecture was chosen for TP 1 to orient the cadets to team members' needs.

An in-class activity was chosen for TP 2 as it is an interactive way to provoke thought and stimulate interest among cadets about expectations that a team member has of a team leader.

A group discussion was chosen for TP 3 as it allows the cadets to interact with their peers and share their knowledge, experiences, opinions and feelings about how a team leader should strive to meet team members needs and expectations.

INTRODUCTION

REVIEW

Nil.

OBJECTIVES

By the end of this lesson the cadet shall be expected to describe the needs and expectations of team members.

IMPORTANCE

It is important for cadets to describe the needs and expectations of team members to assist in the development of their leadership skills. This information aids the cadets in meeting the aim of developing in youth the attributes of good leadership stated in CATO 11-03, *Cadet Program Mandate*. To become an effective team leader, the cadet must be aware of needs and expectations, and strive to satisfy those needs and expectations.

Teaching Point 1**Describe the needs of team members.**

Time: 5 min

Method: Interactive Lecture

THE NEEDS OF TEAM MEMBERS

To be an effective leader, a team leader must be aware that every team member has needs to be satisfied.

Acceptance of and by Other Team Members

Each team member needs to accept the other members of the team. There may be differences in age, gender, race and opinion but each team member should appreciate all other members. In turn, each team member needs to feel accepted by other team members. Once team members feel acknowledged and understood by others on the team, team members may strive to make teamwork possible. Once the team forms into a cohesive group, the accomplishment of a task becomes easier.

Acceptance and Understanding of Leaders

Team members need to know that the team leader will welcome them into the team. It is important for a team leader to encourage a sense of belonging in each team member. Team members also need the team leader to show compassion and sensitivity to their opinions and feelings.

Approval of Leaders

Team members need to know that the team leader appreciates them and their contribution. It is important for team leaders to show respect and praise team members.

Opportunities to Try Different Tasks and Roles

Team members need opportunities to attempt different tasks and roles to practice applying skills and knowledge.

CONFIRMATION OF TEACHING POINT 1**QUESTIONS:**

- Q1. What are the needs of team members?
- Q2. Once team members feel acknowledged and understood by others on the team, what may happen?
- Q3. How do team leaders show approval of team members?

ANTICIPATED ANSWERS:

- A1. The needs of team members are:
 - acceptance of and by other team members;
 - acceptance and understanding of leaders;
 - approval of leaders; and
 - opportunities to try different tasks and roles.
- A2. Once team members feel acknowledged and understood by others on the team, team members strive to make teamwork possible.
- A3. Team leaders show approval of team members by giving team members respect and praise.

Teaching Point 2**Conduct an activity where cadets describe the expectations that a team member has of a team leader.**

Time: 10 min

Method: In-Class Activity

BACKGROUND KNOWLEDGE



The purpose of the in-class activity is to draw the following information from the three groups.

THE EXPECTATIONS THAT A TEAM MEMBER HAS OF A TEAM LEADER

Every team member has expectations of the team leader. Team members hope that the team leader will fulfill their expectations. Team member expectations include:

Good Leadership

Team members expect good leadership from team leaders. Team leaders need to display good leadership, to include:

- **Leading by example.** Team members expect that what they are asked to do can also be done by the team leader. They expect the team leader will model the correct behaviour.
- **Putting the needs of the team members first.** The team leader is expected to put the team's needs ahead of their own. Team members need to know that the team leader will accept, approve and understand them. Team members also expect that the team leader will give them opportunities to try different tasks and roles.
- **Being sensitive to cultural and gender differences.** Each team member is unique and the team leader must have an awareness of the differences between each of them. Having an understanding of cultural and gender differences between members of the team will allow the team members to feel included and appreciated.

Effective Communication

Team members expect that the team leader will provide them with effective communication. Team leaders need to display effective communication to team members, to include:

- **Giving information on what is expected of them.** Team members need to know what is expected of them. Team members require basic information about what they are to accomplish.
- **Explaining changes in situations.** Team members like to know when changes in situations occur. Keeping team members informed of changes and providing new directions may ensure that goals and tasks are accomplished.
- **Asking for assistance with tasks.** Team members are more cooperative when they are asked for assistance by the team leader rather than being ordered to do something. By asking for the team's assistance, team members may feel needed by their team leader.
- **Providing concrete examples during explanations.** Team members may understand concepts and ideas more easily if the team leader uses examples from life and if the team leader can connect the concept or idea to what the team member already knows.

Effective Supervision

Team members expect that the team leader will provide them with effective supervision. Team leaders need to effectively supervise team members, to include:

- **Operating in a safe environment.** Team members expect to be operating in a safe environment. Every team leader must be concerned with the team's safety and well-being at all times.
- **Freedom from over-supervision.** Team members should feel like their team leader has confidence in them to accomplish tasks. Very few team members appreciate it when the team leader is always looking over their shoulder.
- **Recognition of good performance.** Team members like to be praised when things go well. Praise may be verbal or may take the form of certificates and awards.

ACTIVITY

Time: 10 min

OBJECTIVE

The objective of this activity is to have the cadets describe the expectations that a team member has of a team leader.

RESOURCES

- Three flip charts, and
- Three markers.

ACTIVITY LAYOUT

Set a flip chart in three corners of the room.

ACTIVITY INSTRUCTIONS

1. Divide the cadets into three groups.
2. Assign each group to a flip chart.
3. Have each group write one of the headings on the flip chart: Good Leadership, Effective Communication, and Effective Supervision.
4. Have the cadets brainstorm short descriptions for the heading on the flip chart paper for three minutes and write their ideas on the flip chart paper.
5. Have one cadet from each group present their ideas to the rest of the cadets.



Any of the background information that was missed during the presentation by cadets must be stated before moving to the next TP.

SAFETY

Nil.

CONFIRMATION OF TEACHING POINT 2

The cadets' participation in the activity will serve as the confirmation for this TP.

Teaching Point 3

Conduct a group discussion on how a team leader should strive to meet the needs and expectations of team members.

Time: 10 min

Method: Group Discussion



If the class of Proficiency Level Four cadets is large, divide them into groups.

This teaching point has been designed to provide the cadets an opportunity to reflect on and share their opinions and feelings about how a team leader should strive to meet team member's needs and expectations.

BACKGROUND KNOWLEDGE



The purpose of the group discussion is to draw information from the group using the tips for answering / facilitating discussion and the suggested questions provided.

GROUP DISCUSSION



TIPS FOR ANSWERING / FACILITATING DISCUSSION:

- Establish ground rules for discussion, eg, everyone should listen respectfully; don't interrupt; only one person speaks at a time; no one's ideas should be made fun of; you can disagree with ideas but not with the person; try to understand others as much as you hope they understand you; etc.
- Sit the group in a circle, making sure all cadets can be seen by everyone else.
- Ask questions that will provoke thought; in other words avoid questions with yes or no answers.
- Manage time by ensuring the cadets stay on topic.
- Listen and respond in a way that indicates you have heard and understood the cadet. This can be done by paraphrasing their ideas.
- Give the cadets time to respond to your questions.
- Ensure every cadet has an opportunity to participate. One option is to go around the group and have each cadet answer the question with a short answer. Cadets must also have the option to pass if they wish.
- Additional questions should be prepared ahead of time.

SUGGESTED QUESTIONS:

- Q1. Give examples of when you have seen a team leader satisfy the needs of their team members.
- Q2. List ways a team leader might satisfy the needs of their team members.
- Q3. Give examples of when you have seen a team leader meet the expectations of team members.
- Q4. List ways a team leader might meet the expectations of their team.
- Q5. Give examples of when you have seen a team leader not satisfy the needs or not meet the expectations of their team.



Other questions and answers will develop throughout the group discussion. The group discussion should not be limited to only those suggested.



Reinforce those answers given and comments made during the group discussion, ensuring the teaching point has been covered.

CONFIRMATION OF TEACHING POINT 3

The cadets' participation in the group discussion will serve as confirmation of this TP.

END OF LESSON CONFIRMATION**QUESTIONS:**

- Q1. What are the needs of team members?
- Q2. What are the three expectations that team members have of the team leader?
- Q3. List ways a team leader might satisfy the needs or meet the expectations of their team members.

ANTICIPATED ANSWERS:

- A1. The needs of team members are:
 - acceptance of and by other team members;
 - acceptance and understanding of leaders;
 - approval of leaders; and
 - opportunities to try different tasks and roles.

A2. The three expectations that team members have of the team leader are:

- good leadership,
- effective communication, and
- effective supervision.

A3. Answers will vary.



Distribute the Needs and Expectations of Team Members handout located at Attachment A to each cadet.

CONCLUSION

HOMEWORK / READING / PRACTICE

Nil.

METHOD OF EVALUATION

This EO is assessed IAW A-CR-CCP-804/PG-001, *Proficiency Level Four Qualification Standard and Plan*, Chapter 3, Annex B, 403 PC.

CLOSING STATEMENT

To be an effective leader, team leaders must satisfy the needs and meet the expectations of team members. Having an awareness of those needs and expectations will assist the team leader in doing so.

INSTRUCTOR NOTES / REMARKS

Nil.

REFERENCES

A0-047 A-PA-005-000/AP-004 Canadian Defence Academy–Canadian Forces Leadership Institute. (2005). *Leadership in the CF conceptual foundations*. Ottawa, ON: Department of National Defence.

A0-048 A-PA-005-000/AP-003 Canadian Defence Academy–Canadian Forces Leadership Institute. (2005). *Leadership in the CF doctrine foundations*. Ottawa, ON: Department of National Defence.

A0-131 A-CR-CCP-910/PT-001 Director Cadets 6. (1989). *Training school leadership*. Ottawa, ON: Department of National Defence.

C0-115 ISBN 0-7879-4059-3 van Linden, J. A., & Fertman, C. I. (1998). *Youth leadership*. San Francisco, CA: Jossey-Bass Inc., Publishers.

NEEDS AND EXPECTATIONS OF TEAM MEMBERS

THE NEEDS OF TEAM MEMBERS

To be an effective leader, a team leader must be aware that every team member has needs to be satisfied.

Acceptance of and by Other Team Members

Each team member needs to accept the other members of the team. There may be differences in age, gender, race and opinion but each team member should appreciate all other members. In turn, each team member needs to feel accepted by other team members. Once team members feel acknowledged and understood by others on the team, team members may strive to make teamwork possible. Once the team forms into a cohesive group, the accomplishment of a task becomes easier.

Acceptance and Understanding of Leaders

Team members need to know that the team leader will welcome them into the team. It is important for a team leader to encourage a sense of belonging in each team member. Team members also need the team leader to show compassion and sensitivity to their opinions and feelings.

Approval of Leaders

Team members need to know that the team leader appreciates them and their contribution. It is important for team leaders to show respect and praise team members.

Opportunities to Try Different Tasks and Roles

Team members need opportunities to attempt different tasks and roles to practice applying skills and knowledge.

THE EXPECTATIONS THAT A TEAM MEMBER HAS OF A TEAM LEADER

Every team member has expectations of the team leader. Team members hope that the team leader will fulfill their expectations. Team member expectations include:

Good Leadership

Team members expect good leadership from team leaders. Team leaders need to display good leadership, to include:

- **Leading by example.** Team members expect that what they are asked to do can also be done by the team leader. They expect the team leader will model the correct behaviour.
- **Putting the needs of the team members first.** The team leader is expected to put the team's needs ahead of their own. Team members need to know that the team leader will accept, approve and understand them. Team members also expect that the team leader will give them opportunities to try different tasks and roles.
- **Being sensitive to cultural and gender differences.** Each team member is unique and the team leader must have an awareness of the differences between each of them. Having an understanding of cultural and gender differences between members of the team will allow the team members to feel included and appreciated.

Effective Communication

Team members expect that the team leader will provide them with effective communication. Team leaders need to display effective communication to team members, to include:

- **Giving information on what is expected of them.** Team members need to know what is expected of them. Team members require basic information about what they are to accomplish.
- **Explaining changes in situations.** Team members like to know when changes in situations occur. Keeping team members informed of changes and providing new directions may ensure that goals and tasks are accomplished.
- **Asking for assistance with tasks.** Team members are more cooperative when they are asked for assistance by the team leader rather than being ordered to do something. By asking for the team's assistance, team members may feel needed by their team leader.
- **Providing concrete examples during explanations.** Team members may understand concepts and ideas more easily if the team leader uses examples from life and if the team leader can connect the concept or idea to what the team member already knows.

Effective Supervision

Team members expect that the team leader will provide them with effective supervision. Team leaders need to effectively supervise team members, to include:

- **Operating in a safe environment.** Team members expect to be operating in a safe environment. Every team leader must be concerned with the team's safety and well-being at all times.
- **Freedom from over-supervision.** Team members should feel like their team leader has confidence in them to accomplish tasks. Very few team members appreciate it when the team leader is always looking over their shoulder.
- **Recognition of good performance.** Team members like to be praised when things go well. Praise may be verbal or may take the form of certificates and awards.



**COMMON TRAINING
PROFICIENCY LEVEL FOUR
INSTRUCTIONAL GUIDE**



SECTION 2

EO M403.02 – SELECT A LEADERSHIP APPROACH

Total Time:

60 min

PREPARATION

PRE-LESSON INSTRUCTIONS

Resources needed for the delivery of this lesson are listed in the lesson specification located in A-CR-CCP-804/PG-001, *Proficiency Level Four Qualification Standard and Plan*, Chapter 4. Specific uses for said resources are identified throughout the instructional guide within the TP for which they are required.

Review the lesson content and become familiar with the material prior to delivering the lesson.

Photocopy the handouts located at Attachments A, B and D for each cadet.

Photocopy the scenarios located at Attachment C. Cut out a scenario for each cadet.

PRE-LESSON ASSIGNMENT

Nil.

APPROACH

An interactive lecture was chosen for TPs 1, 2 and 3 to review, clarify, emphasize and summarize transactional and transformational leadership, the outcomes of a team leader's focus and leadership approaches.

An in-class activity was chosen for TP 4 as it is an interactive way to provoke thought and stimulate interest among cadets.

INTRODUCTION

REVIEW

Nil.

OBJECTIVES

By the end of this lesson the cadet shall have selected a leadership approach.

IMPORTANCE

It is important for cadets to select a leadership approach in order to help them become effective team leaders during a leadership appointment. For every leadership opportunity, an effective leader will use a leadership approach that enables the team members to accomplish the goal.

Teaching Point 1**Describe transactional and transformational leadership.**

Time: 5 min

Method: Interactive Lecture

TRANSACTIONAL AND TRANSFORMATIONAL LEADERSHIP

Transactional leadership. Leaders exchange promises of rewards and benefits to team members so the team members will fulfill agreements with the leaders. This type of leadership is task-oriented. The leader sets the rules and procedures to complete a task and the team members comply with the rules and follow the procedures to accomplish the task.

Transactional Leadership:

- Values problem and solution identification.
- Makes decisions – even if everyone has not been heard – in order to move forward.
- Uses standards and principles as guides in decision making.
- Develops the self to be a better decision maker for the group.
- Gets things done.
- Recognizes the importance of the product.
- Takes charge (personal power).

Transformational leadership. Focuses on the process of being a leader by helping team members transform themselves from followers into leaders. Transformational leadership involves assisting team members to transcend their own self-interest for the good of the group, organization or society; to consider their long-term needs to develop themselves, rather than their immediate needs; and generally, to become more aware of what is really important.

Transformational Leadership:

- Values the participation and contribution of others.
- Takes all viewpoints and advice into account before making a decision.
- Considers individuals within their contexts and situations.
- Uses individuals to test decisions.
- Develops the self first to be a better contributor to the group.
- Learns from experiences to generalize to 'real life'.
- Recognizes the importance of the process.
- Shares leadership (group power).



Leadership within the cadet program has been designed to create transformational leadership. Transformational leadership enables the Cadet Program to meet its first aim—to develop in youth the attributes of good citizenship and leadership.

Transactional leadership focuses on the skills and tasks associated with leadership, such as public speaking, writing, delegating authority, leading meetings and making decisions. It is what people who are leaders do.

Transformational leadership focuses on the process of leadership and what it means to be a leader. It is concerned with how individuals use their abilities to influence people. Think of the main difference between transactional and transformational leadership as doing leadership tasks versus being a leader.

CONFIRMATION OF TEACHING POINT 1

QUESTIONS:

- Q1. Describe transactional leadership.
- Q2. On what does transformational leadership focus?
- Q3. Leadership within the cadet program has been designed to create which kind of leadership?

ANTICIPATED ANSWERS:

- A1. Transactional leadership is when leaders exchange promises of rewards and benefits to team members so the team members will fulfill agreements with the leaders.
 - A2. Transformational leadership focuses on the process of being a leader by helping team members transform themselves from followers into leader.
 - A3. Leadership within the cadet program has been designed to create transformational leadership.
-

Teaching Point 2

Describe the outcomes that occur as a result of the team leader focussing on team members and the goal.

Time: 10 min

Method: Interactive Lecture



Distribute Attachment A to each cadet.

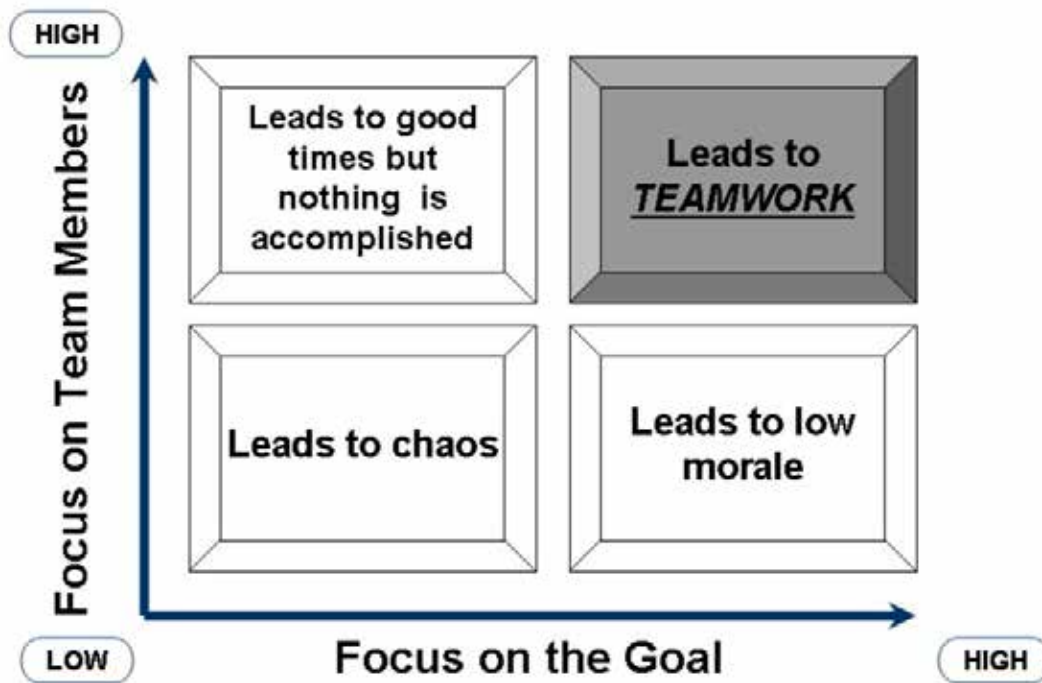



Figure 1 Outcomes as a Result of the Team Leader's Focus

Note. Created by Director Cadets 3, 2009, Ottawa, ON: Department of National Defence.

There are two main things on which to focus while leading a team: the team members and the goal.

If a team leader is not focused on the goal and is not focused on their team members, the outcome is usually chaos.



Ask cadets why they think chaos would occur. Ask cadets to provide one or two examples, from a leadership perspective, when they have seen such chaos occur. The examples do not necessarily need to involve the Cadet Program (CP).

If a team leader is not concerned with the goal but is highly concerned about how their team members feel, the outcome may lead to good times but nothing gets accomplished.



Ask cadets why they think the result of good times but nothing gets accomplished may occur. Ask cadets to provide one or two examples, from a leadership perspective, when they have seen good times occur but nothing gets accomplished. The examples do not necessarily need to involve the CP.

If a team leader is highly concerned with the goal but not concerned about how their team member's feel, the outcome may lead to low morale.



Ask cadets why they think low morale would occur. Ask cadets to provide one or two examples, from a leadership perspective, of when they have seen low morale occur. The examples do not necessarily need to involve the CP.

If a team leader is highly concerned with the goal and highly concerned about how their team members feel, the outcome is usually teamwork.



Ask cadets why they think teamwork would occur. Ask cadets to provide one or two examples, from a leadership perspective, when they have seen teamwork occur. The examples do not necessarily need to involve the CP.



Every leadership opportunity within the cadet program has been designed to create teamwork.

CONFIRMATION OF TEACHING POINT 2

QUESTIONS:

- Q1. What are the two main things on which a team leader needs to focus while leading a team?
- Q2. If a team leader is not focused on the goal and is not focused on their team members, what is usually the outcome?
- Q3. What has every leadership opportunity within the CP has been designed to create?

ANTICIPATED ANSWERS:

- A1. The team leader needs to focus on the team members and on the goal.
- A2. If a team leader is not focused on the goal and is not focused on their team members, the outcome is usually chaos.
- A3. Every leadership opportunity within the CP has been designed to create teamwork.

Teaching Point 3

Describe leadership approaches.

Time: 15 min

Method: Interactive Lecture

LEADERSHIP APPROACHES

There are three main leadership approaches in the CP. They are:

- control,
- coach and
- empower.

Each leadership approach is based on balancing the concern for the relationship with team members for the concern for accomplishing the task.

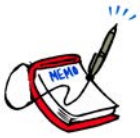

Distribute Attachment B to each cadet.

Key Aspects of the Control Approach

Key aspects of the control approach are:

- The team leader defines the roles and tasks for the team members. The team leader gives the team members clear direction and supervises them closely.
- The team leader provides detailed explanations on what needs to be done and gives team members the information they need to know on how to do the task.
- Communication is mainly one-way.

Key Aspects of the Coach Approach

Key aspects of the coach approach are:

- The roles and tasks are still defined by the team leader but ideas and suggestions are solicited from team members.
- The team leader provides information and opinions but supports the team to develop possible solutions to problems while the final decision remains with the team leader.
- The team leader encourages team members to assume responsibility.
- Communication is mainly two-way.

Key Aspects of the Empower Approach

Key aspects of the empower approach are:

- The team leader empowers team members to make decisions and take action in areas where the team members have experience and expertise.
- Team members can operate independently and have a strong sense of responsibility but know when to seek assistance from the team leader.
- Communication is mainly two-way.

Selecting the Approach

Each of the three leadership approaches may be equally effective. The approach selected must be based on the leadership assignment and / or appointment and the leadership team.

The factors to be considered when looking at the leadership assignment / appointment are:

- the level of simplicity of the task; and
- the level of safety of cadets.

The factors to be considered when looking at the leadership team are:

- the level of capability / competence of cadets; and
- the level of motivation of cadets.

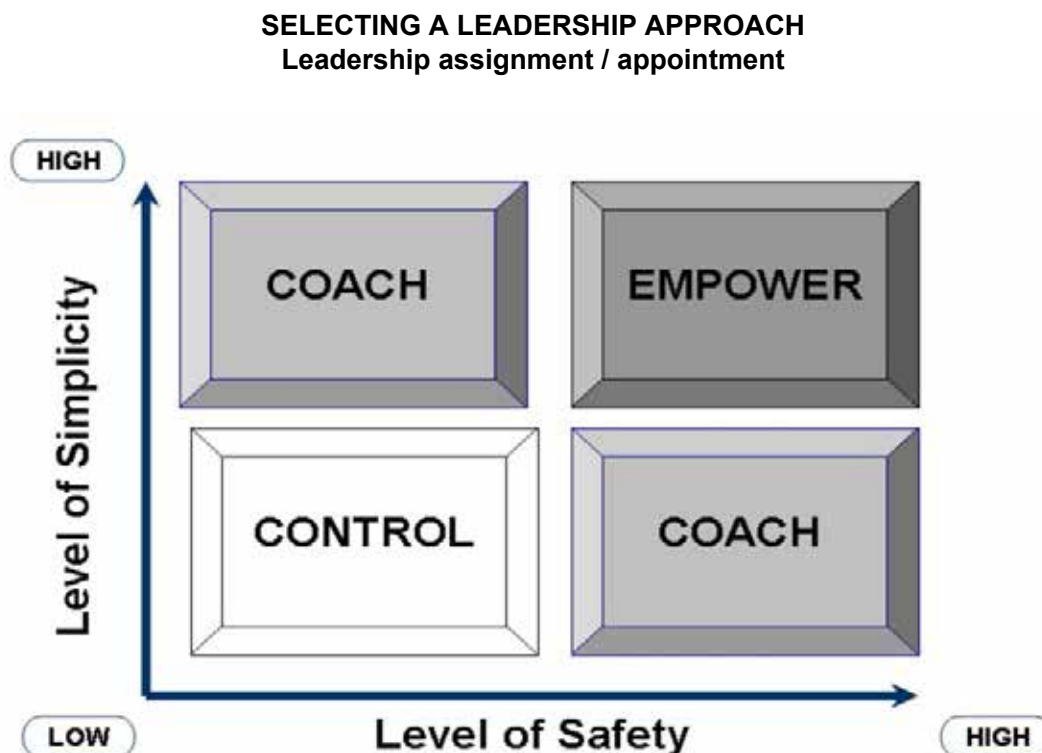

Figure 2 Selecting a Leadership Approach

Note. Created by Director Cadets 3, 2009, Ottawa, ON: Department of National Defence.

If the task is complicated and the cadets are doing something with some risk, the team leader should choose the control approach. This allows for better supervision of team members.

If the task is simple but the cadets are doing something with some risk, the team leader should choose the coaching approach. This allows the team members an opportunity to develop their leadership skills and knowledge because the team leader provides extra feedback.

If the task is complicated but the cadets are doing something without risk, the team leader should choose the coaching approach. This allows the team members an opportunity to develop their leadership skills and knowledge because the team leader provides extra feedback.

If the task is simple and the cadets are doing something without risk, the team leader should choose the empower approach. This allows the team members develop their leadership skills and their sense of responsibility.



Have cadets give examples of when they have seen each approach used based on the simplicity of the task and the level of safety.

SELECTING A LEADERSHIP APPROACH

Leadership team

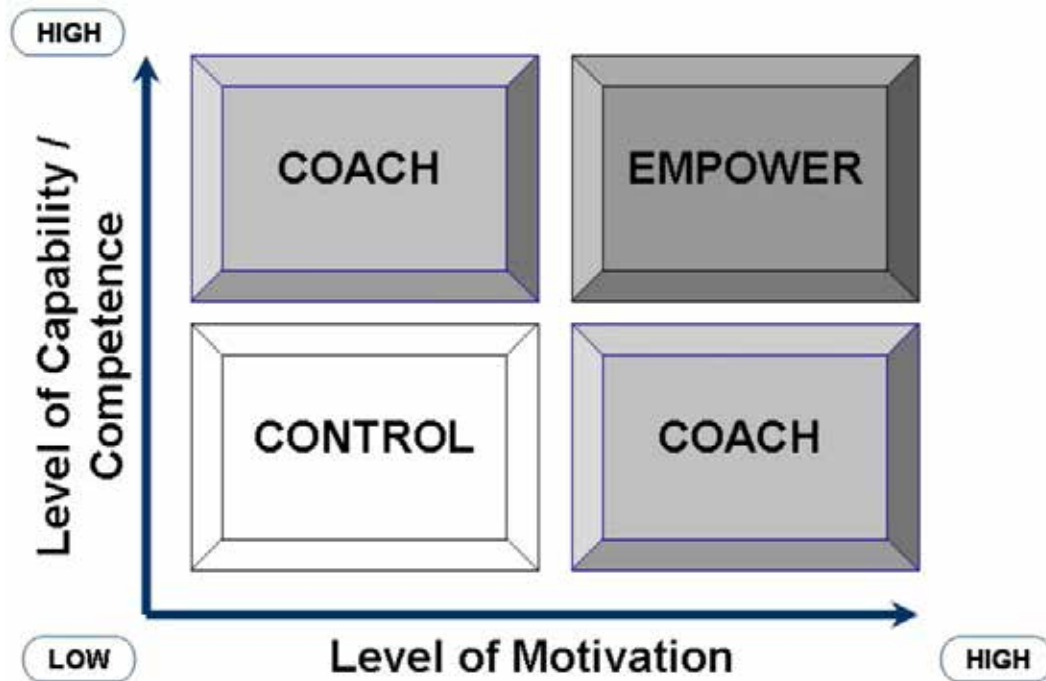

Figure 3 Selecting a Leadership Approach

Note. Created by Director Cadets 3, 2009, Ottawa, ON: Department of National Defence.

If the task is new or the task is difficult and the cadets are uninspired or apathetic, the team leader should choose the control approach. This allows for better supervision of cadets.

If the team has experience with the task but the cadets are uninspired or apathetic, the team leader should choose the coaching approach. This allows the team members an opportunity to develop their leadership skills and knowledge because the team leader provides extra feedback.

If the task is new or the task is difficult, but the cadets are inspired and enthusiastic, the team leader should choose the coaching approach. This allows the team members an opportunity to develop their leadership skills and knowledge because the team leader provides extra feedback.

If the team has experience with the task, and the cadets are inspired and enthusiastic, the team leader should choose the empower approach. This allows the team members to develop their leadership skills and their sense of responsibility by giving opportunities to operate independently.



Have cadets give examples of when they have seen each approach used based on the capability / competence of the team and the level of motivation.

CONFIRMATION OF TEACHING POINT 3**QUESTIONS:**

- Q1. Name the three leadership approaches used in the CP.
- Q2. Which leadership approach is based on one-way communication?
- Q3. What are the four topics that must be considered when selecting a leadership approach?

ANTICIPATED ANSWERS:

- A1. The three leadership approaches used in the CP are:
- control,
 - coach, and
 - empower.
- A2. The leadership approached based on one-way communication is control.
- A3. The four factors that must be considered when selecting a leadership approach are:
- the level of simplicity of the task;
 - the level of safety of cadets;
 - the level of capability / competence of cadets; and
 - the level of motivation level of cadets.

Teaching Point 4

Conduct an activity where cadets will explain what leadership approach they would select and why for a given scenario.

Time: 20 min

Method: In-Class Activity

ACTIVITY**OBJECTIVE**

The objective of this activity is to have the cadets explain what leadership approach would be selected and why for a given scenario.

RESOURCES

Scenarios.

ACTIVITY LAYOUT

Nil.

ACTIVITY INSTRUCTIONS

1. Distribute a scenario located at Attachment C to each cadet.
2. Allow the cadet two minutes to read and think about the scenario.

3. Have the cadet select what leadership approach they would use to complete the scenario.
4. Have one cadet read their scenario out loud and explain which leadership approach they would choose and why. The explanation of the selection must be based on the information provided during TP3.
5. Allow the other cadets to comment on the choice and reasons.
6. Repeat Steps 4 and 5 until each cadet has had a turn.

SAFETY

Nil.

CONFIRMATION OF TEACHING POINT 4

The cadets' participation in the activity will serve as the confirmation of this TP.

END OF LESSON CONFIRMATION



Distribute the handout located at Attachment D to each cadet.

The cadets' participation in the in-class activity will serve as the confirmation of this lesson.

CONCLUSION

HOMEWORK / READING / PRACTICE

Nil.

METHOD OF EVALUATION

This EO is assessed IAW A-CR-CCP-804/PG-001, *Proficiency Level Four Qualification Standard and Plan*, Chapter 3, Annex B, 403 PC.

CLOSING STATEMENT

In every leadership opportunity, the effective team leader will use a leadership approach that enables the team leader to have a positive relationship with their team members and to accomplish tasks. Selecting and implementing leadership approaches is a life-long transformational leadership skill.

INSTRUCTOR NOTES / REMARKS

Cadets will select leadership approaches during leadership assignments and leadership appointments throughout the training year.

REFERENCES

C0-115 ISBN 0-7879-4059-3 van Linden, J. A., & Fertman, C. I. (1998). *Youth leadership*. San Francisco, CA: Jossey-Bass Inc., Publishers.

C0-410 The ASPIRA Association. (2009). *Module #5: Defining leadership styles*. Retrieved on February 12, 2009, from http://www.aspira.org/files/documents/youthdev08/U_V_M_5_dls.pdf

C0-413 University of Arkansas, Division of Agriculture, Cooperative Extension Service. (2006). *4-H volunteer leaders' series: The enabler—A leadership style*. Retrieved February 18, 2009, from http://www.uaex.edu/other_areas/publications/PDF/4HCD2.pdf

THIS PAGE INTENTIONALLY LEFT BLANK

OUTCOMES AS A RESULT OF THE TEAM LEADER'S FOCUS

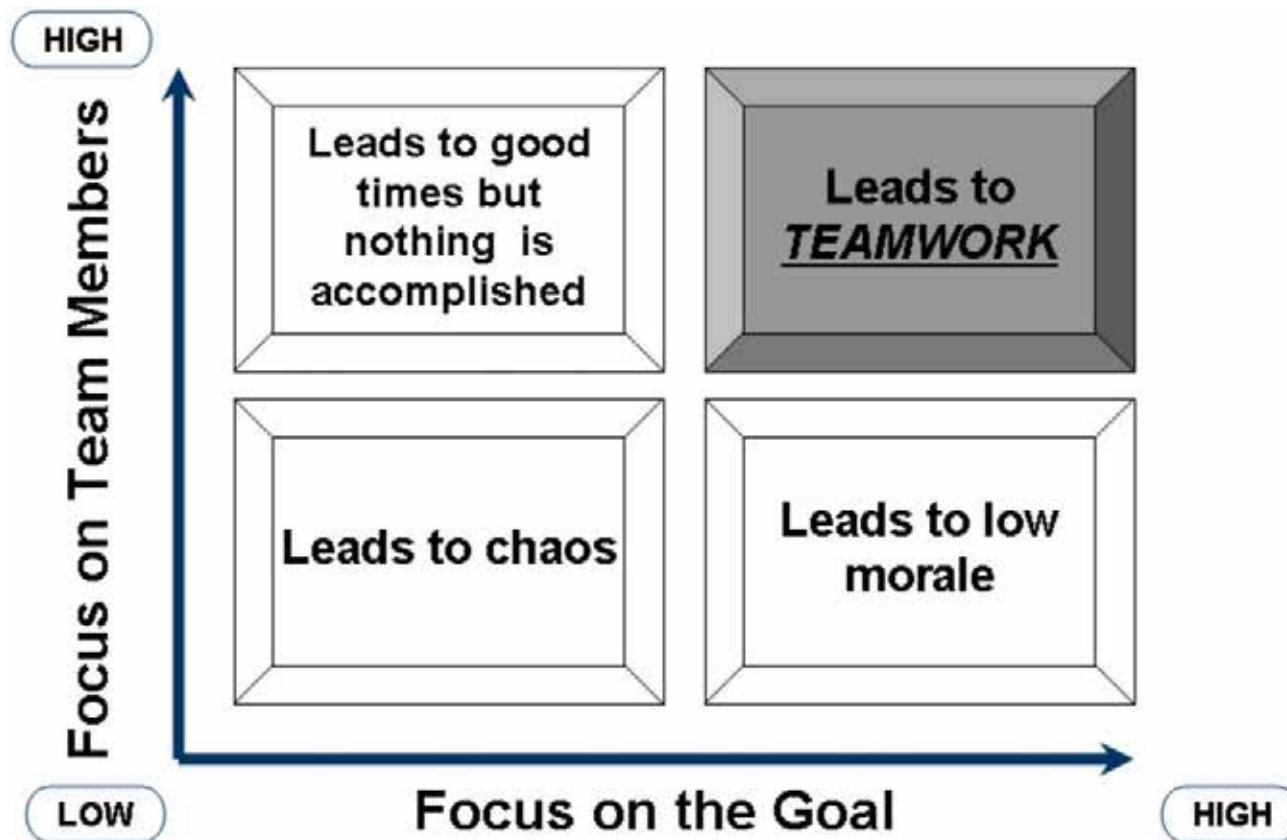

Figure A-1 Outcome as a Result of the Team Leader's Focus

Note. Created by Director Cadets 3, 2009, Ottawa, ON: Department of National Defence

THIS PAGE INTENTIONALLY LEFT BLANK

KEY ASPECTS OF EACH LEADERSHIP APPROACH



Key aspects of this approach:

- The leader defines the roles and tasks for the team members, gives them clear direction and supervises them closely.
- The leader provides detailed explanations on what needs to be done and gives the team members the information they need on how to do the task.
- Communication is mainly one-way.



Key aspects of this approach:

- The roles and tasks are still defined by the leader but ideas and suggestions are solicited from team members.
- The leader provides information and opinions but supports the team to develop possible solutions to problems while the final decision remains with the leader.
- The leader encourages members of the team to assume responsibility
- Communication is mainly two-way.

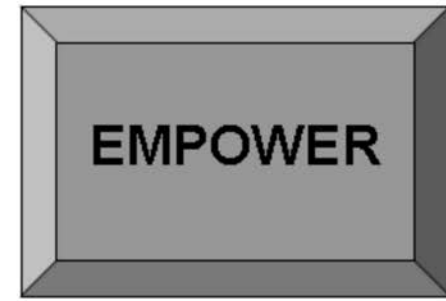

Key aspects of this approach:

- The leader empowers members of the team to make decisions and take action in areas where they have experience and expertise.
- Members of the team can operate independently and have a strong sense of responsibility but know when to seek assistance from the leader.
- Communication is mainly two-way.

Figure B-1 Key Aspects of Leadership Approaches

Note. Created by Director Cadets 3, 2009, Ottawa, ON: Department of National Defence

SELECTING A LEADERSHIP APPROACH ***Leadership assignment / appointment***

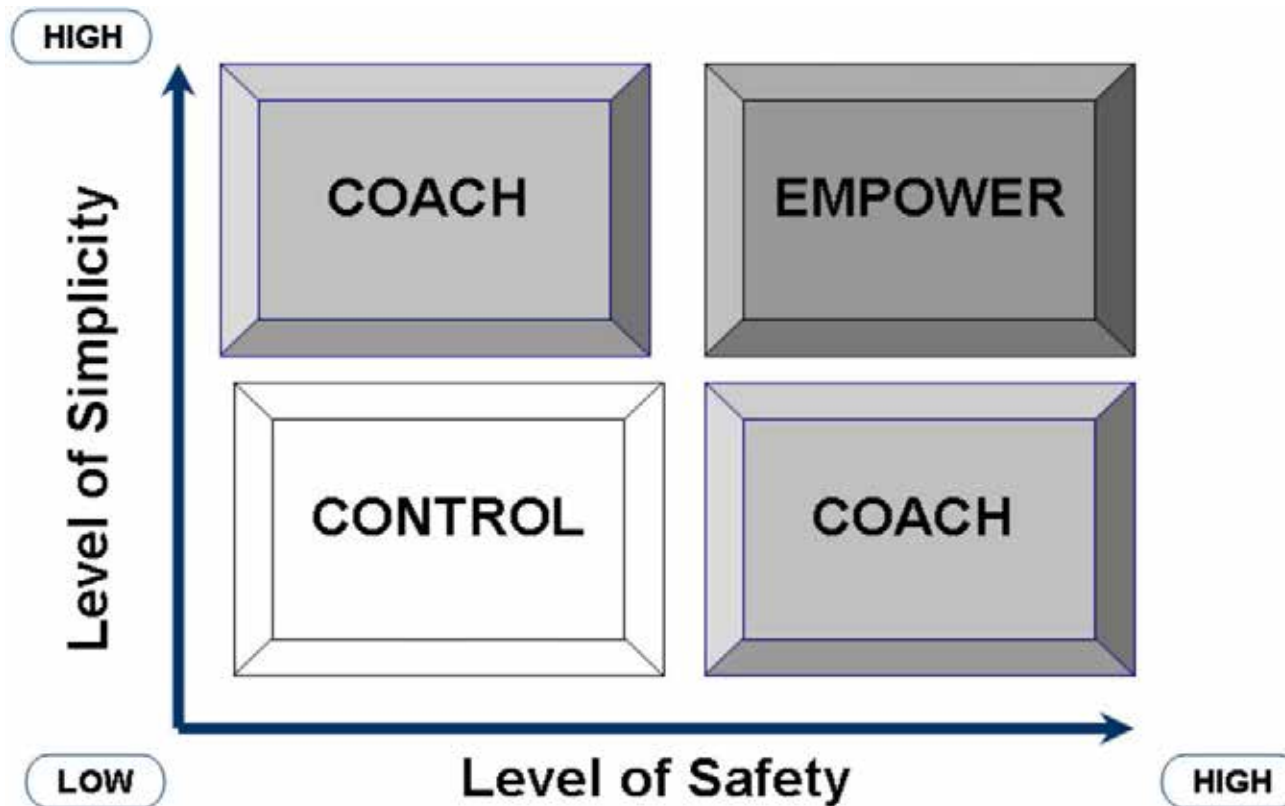

Figure B-2 Selecting a Leadership Approach

Note. Created by Director Cadets 3, 2009, Ottawa, ON: Department of National Defence

SELECTING A LEADERSHIP APPROACH

Leadership team

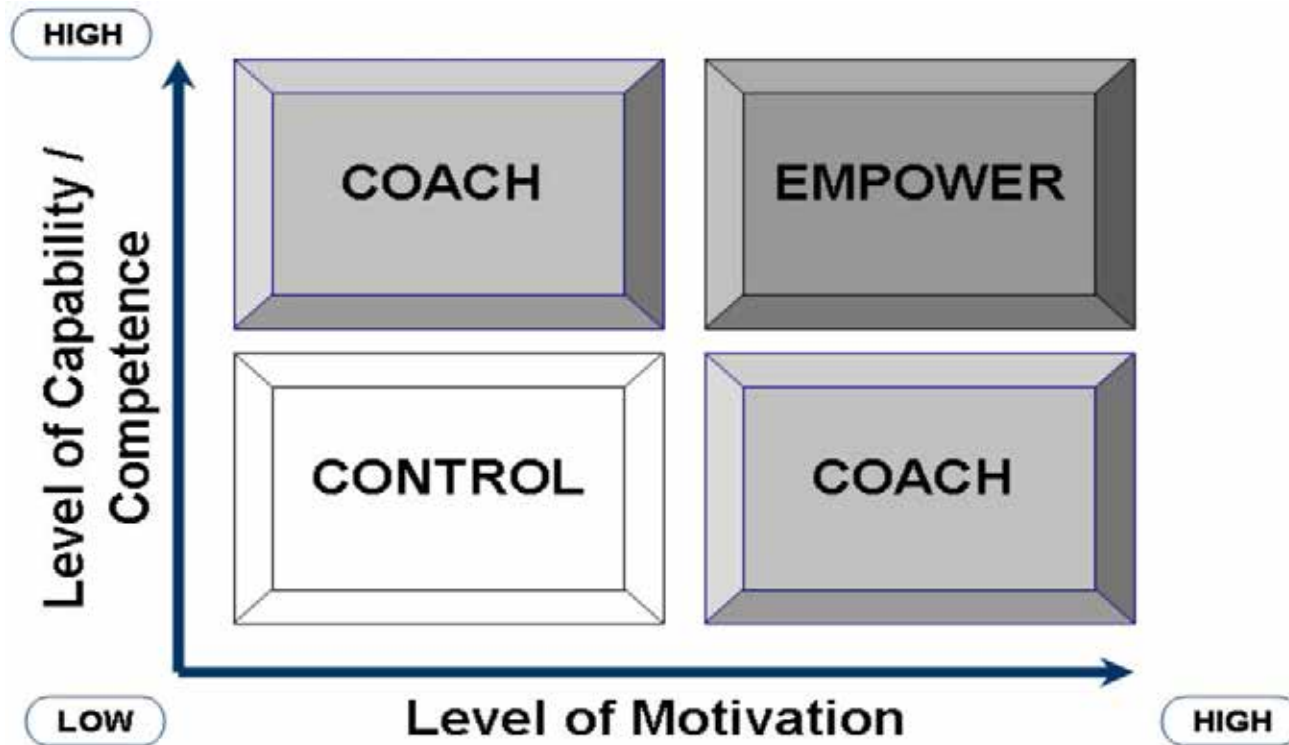

Figure B-3 Selecting a Leadership Approach

Note. Created by Director Cadets 3, 2009, Ottawa, ON: Department of National Defence

THIS PAGE INTENTIONALLY LEFT BLANK

SCENARIOS

SCENARIO #1

You and your team have been tasked with providing the first year cadets with one hour of team-building games. This activity will take place next parade night.

SCENARIO #2

You and your team have been tasked with setting up two classrooms. The class will begin in 10 minutes.

SCENARIO #3

You and your team have been tasked with operating the canteen at breaks. The canteen has not been stocked and must be ready to go in two weeks.

SCENARIO #4

You and your team have been tasked with putting away all the flags, poles and a dais from the Commanding Officer's parade. The parade will be over in two hours.

SCENARIO #5

You and your team have been tasked with taking attendance of all 13-year-old cadets before everyone departs the building. The parade night ends in 30 minutes.

SCENARIO #6

You and your team have been tasked with ensuring all lights have been turned off and all inner doors are locked at the end of every parade night.

SCENARIO #7

You and your team have been tasked with providing first year cadets with tutoring in how to wear their uniforms throughout the training year.

SCENARIO #8

You and your team have been tasked with conducting one sports activity to be held during the next parade night.

THIS PAGE INTENTIONALLY LEFT BLANK

TRANSACTIONAL AND TRANSFORMATIONAL LEADERSHIP

Transactional leadership. Leaders exchange promises of rewards and benefits to team members so the team members will fulfill agreements with the leaders. This type of leadership is task-oriented. The leader sets the rules and procedures to complete a task and the team members comply with the rules and follow the procedures to accomplish the task.

Transactional Leadership:

- Values problem and solution identification.
- Makes decisions – even if everyone has not been heard – in order to move forward.
- Uses standards and principles as guides in decision making.
- Develops the self to be a better decision maker for the group.
- Gets things done.
- Recognizes the importance of the product.
- Takes charge (personal power).

Transformational leadership. Focuses on the process of being a leader by helping team members transform themselves from followers into leaders. Transformational leadership involves assisting team members to transcend their own self-interest for the good of the group, organization or society; to consider their long-term needs to develop themselves, rather than their immediate needs; and generally, to become more aware of what is really important.

Transformational Leadership:

- Values the participation and contribution of others.
- Takes all viewpoints and advice into account before making a decision.
- Considers individuals within their contexts and situations.
- Uses individuals to test decisions.
- Develops the self first to be a better contributor to the group.
- Learns from experiences to generalize to 'real life'.
- Recognizes the importance of the process.
- Shares leadership (group power).



Leadership within the cadet program has been designed to create transformational leadership. Transformational leadership enables the Cadet Program to meet its first aim—to develop in youth the attributes of good citizenship and leadership.

Transactional leadership focuses on the skills and tasks associated with leadership, such as public speaking, writing, delegating authority, leading meetings and making decisions. It is what people who are leaders do. Transformational leadership focuses on the process of leadership and what it means to be a leader. It is concerned with how individuals use their abilities to influence people. Think of the main difference between transactional and transformational leadership as doing leadership tasks versus being a leader.



**COMMON TRAINING
PROFICIENCY LEVEL FOUR
INSTRUCTIONAL GUIDE**



SECTION 3

EO M403.03 – MOTIVATE TEAM MEMBERS

Total Time:

60 min

PREPARATION

PRE-LESSON INSTRUCTIONS

Resources needed for the delivery of this lesson are listed in the lesson specification located in A-CR-CCP-804/PG-001, *Proficiency Level Four Qualification Standard and Plan*, Chapter 4. Specific uses for said resources are identified throughout the instructional guide within the TP for which they are required.

Review the lesson content and become familiar with the material prior to delivering the lesson.

Photocopy the handouts located at Attachments A, B and C for each cadet.

PRE-LESSON ASSIGNMENT

Nil.

APPROACH

An in-class activity was chosen for TP 1 as it is an interactive way to provoke thought and stimulate interest among cadets about advantages and disadvantages of extrinsic and intrinsic motivators.

An interactive lecture was chosen for TP 2 to orient the cadets to encourage intrinsic motivation.

A group discussion was chosen for TP 3 as it allows the cadets to interact with their peers and share their knowledge, experiences, opinions and feelings about when and how to motivate team members.

INTRODUCTION

REVIEW

Nil.

OBJECTIVES

By the end of this lesson the cadet shall motivate team members.

IMPORTANCE

It is important for cadets to motivate team members because motivation is the key ingredient for success in the cadet organization. One of the duties of a team leader is to motivate team members to succeed to accomplish goals. Motivating team members also may encourage team members to develop new knowledge and skills. In addition, recognizing team members for the effort they put toward a task makes them feel appreciated.

Teaching Point 1

Conduct an in-class activity where the cadets will explain to each other the advantages and disadvantages of extrinsic and intrinsic motivators.

Time: 20 min

Method: In-Class Activity

ACTIVITY**OBJECTIVE**

The objective of this activity is to have the cadets explain to each other the advantages and disadvantages of extrinsic and intrinsic motivators.

RESOURCES

- Two flip charts,
- Two markers,
- Extrinsic Motivators handout located at Attachment A, and
- Intrinsic Motivators handout located at Attachment B.

ACTIVITY LAYOUT

Nil.

ACTIVITY INSTRUCTIONS

1. Divide the class into two groups.
2. Distribute the handout located at Attachment A to group A.
3. Distribute the handout located at Attachment B to group B.
4. Have each group read and complete their handout for two minutes.
5. Have group A list the examples of extrinsic motivators from their handout on the flip chart paper.
6. Have group B list the examples of intrinsic motivators from their handout on the flip chart paper.
7. After 10 minutes, have each cadet from group A find a cadet from group B with whom they will share the information.
8. Have each cadet from group A explain what extrinsic motivators are, their advantages and disadvantages, and give examples to the cadet from group B. The cadet from group B must paraphrase the answers from the cadet from group A.
9. Have each cadet from group B explain what intrinsic motivators are, their advantages and disadvantages, and give examples to the cadet from group A. The cadet from group A must paraphrase the answers from the cadet from group B.
10. Distribute the handout located at Attachment B to the cadets from group A. Distribute the handout located at Attachment A to the cadets from group B.

SAFETY

Nil.

CONFIRMATION OF TEACHING POINT 1

The cadets' participation in the activity will serve as confirmation of the TP.

Teaching Point 2

Explain why team leaders should encourage intrinsic motivation.

Time: 5 min

Method: Interactive Lecture

WHY TEAM LEADERS SHOULD ENCOURAGE INTRINSIC MOTIVATION



Display the following statement on a presentation aid (eg, whiteboard / flip chart / OHP / multimedia projector), "Leaders do things right and they do the right things."

Have the cadets reflect upon the saying while thinking about whether extrinsic or intrinsic motivation should be used by their team members.

As a team leader, cadets should lead by example and be intrinsically motivated to accomplish goals and tasks. Although this may be difficult, team leaders need to accomplish their goals and believe the goals are worth accomplishing.

When a team leader leads by example, the team members may also realize that accomplishing goals and tasks are a good and right thing to do.

When a team leader displays intrinsic motivation, team members may realize that intrinsic motivation is an attribute to be imitated. Any positive attribute that a team member imitates may assist the team member in becoming a better leader in the future.

As an example, a team leader will wear their uniform correctly because it is the right thing to do. A team leader takes pride in their uniform and does not need to be given an external reward to do this. Team members see this behaviour and want to be like their team leader and may not continue to need external rewards. Team members begin to imitate the team leader and become intrinsically motivated.



Have the cadets give other examples of how team leaders have encouraged intrinsic motivation in their team members.

It is important to remember that extrinsic motivation will boost morale for a only short period of time.

CONFIRMATION OF TEACHING POINT 2

QUESTIONS:

- Q1. While using intrinsic motivation, why do team leaders need to accomplish goals and tasks?
- Q2. What happens when a team leader displays intrinsic motivation?
- Q3. Give an example of a team leader encouraging intrinsic motivation in team members.

ANTICIPATED ANSWERS:

- A1. While using intrinsic motivation, team leaders need to accomplish goals and tasks because they believe the goals and tasks are worth accomplishing.
- A2. When a team leader displays intrinsic motivation, team members realize that intrinsic motivation is an attribute to be imitated.
- A3. Answers will vary.

Teaching Point 3

Conduct a group discussion about when and how team leaders motivate team members.

Time: 25 min

Method: Group Discussion

BACKGROUND KNOWLEDGE



The purpose of the group discussion is to draw the following information from the group using the tips for answering / facilitating discussion and the suggested questions provided.

WHEN TEAM LEADERS MOTIVATE TEAM MEMBERS

The team leader must motivate team members. The skill of knowing when your team members need to be motivated will develop over time. As a team leader during Proficiency Level Four, it is important to motivate team members at every opportunity.

HOW TEAM LEADERS MOTIVATE TEAM MEMBERS

One of the most common methods used to motivate team members is to use praise. Verbal praise is a very effective way to motivate team members.

Verbal praise may be used as positive feedback before, during and at the end of tasks. If possible, team leaders should praise team members in front of others as it makes team members feel valued.

Praising Effort and Perseverance During a Task

It is very important for team leaders to praise team members for their effort and perseverance during a task. Encouraging and caring about team members is an important aspect of being a leader.

Praising the use of Different Strategies During a Task

Team leaders should praise team members when they use different strategies to during a task. Creative thinking is an important tool for leaders.

Praising Improvement During a Task

When team members have completed a task before and they complete the task again more effectively or efficiently, praise should be given. Leaders and team members should always try to improve their performance.

Encouraging the Development of Knowledge and Skills

Team leaders should encourage team members when they learn something new. Everything new that a team member learns may be used at some point to assist the team.

Praising the Completion of a Task

When team members complete a task, praise should be given. It is important to recognize dedication shown in seeing a task through to completion.

Thanking Team Members for Their Endeavours

Team leaders should try to recognize each team member for their contribution in the completion of a task. Making team members feel special is a great way to win even more cooperation from the team.

Giving credit for the completion of tasks to the team rather than yourself

When team leaders are given credit for completing a task, they should ensure that credit is given also to the team members. Recognizing the team for their accomplishments boosts the team's morale.



When team leaders model praise correctly, they lead by example. This may help team members begin to use the same strategies, thus reinforcing motivation.

GROUP DISCUSSION



TIPS FOR ANSWERING / FACILITATING DISCUSSION:

- Establish ground rules for discussion, eg, everyone should listen respectfully; don't interrupt; only one person speaks at a time; no one's ideas should be made fun of; you can disagree with ideas but not with the person; try to understand others as much as you hope they understand you; etc.
- Sit the group in a circle, making sure all cadets can be seen by everyone else.
- Ask questions that will provoke thought; in other words avoid questions with yes or no answers.
- Manage time by ensuring the cadets stay on topic.
- Listen and respond in a way that indicates you have heard and understood the cadet. This can be done by paraphrasing their ideas.
- Give the cadets time to respond to your questions.
- Ensure every cadet has an opportunity to participate. One option is to go around the group and have each cadet answer the question with a short answer. Cadets must also have the option to pass if they wish.
- Additional questions should be prepared ahead of time.

SUGGESTED QUESTIONS:

- Q1. Give some examples of when a team leader may praise their team members.
- Q2. Give some examples of what a team leader might say to praise their team members.
- Q3. Give some examples of when you were praised by team members, team leaders, activity managers, officers or adults?

Q4. How do you feel when you are praised by team members, team leaders, activity managers, officers or adults?

Q5. Why is praise an important tool for motivating team members?



Other questions and answers will develop throughout the group discussion. The group discussion should not be limited to only those suggested.



Reinforce those answers given and comments made during the group discussion, ensuring the teaching point has been covered.

CONFIRMATION OF TEACHING POINT 3

The cadets' participation in the group discussion will serve as the confirmation of this TP.

END OF LESSON CONFIRMATION

The cadets' participation in the group discussion in TP 3 will serve as the confirmation of this lesson.



Distribute the handout located at Attachment C to each cadet.

CONCLUSION

HOMework / READING / PRACTICE

Nil.

METHOD OF EVALUATION

This EO is assessed IAW A-CR-CCP-804/PG-001, *Proficiency Level Four Qualification Standard and Plan*, Chapter 3, Annex B 403 PC.

CLOSING STATEMENT

One of the duties of a team leader is to motivate team members to succeed to accomplish goals. Motivating team members also may encourage them to develop new knowledge and skills. In addition, recognizing team members for the effort they put towards a task makes them feel appreciated.

INSTRUCTOR NOTES / REMARKS

Nil.

REFERENCES

- C0-245 ISBN 1-58062-513-4 Adams, B. (2001). *The everything leadership book*. Avon, MA: Adams Media.
- C0-401 ISBN 0-7879-6068-3 Hesselbein, F., & Johnston, R. (2002). *A leader to leader guide: On mission and leadership*. San Francisco, CA: Jossey-Bass Publishing.
- C0-411 Dweck, C. S. (2007). The perils and promises of praise. *Education Leadership*, 65(2), 34-39.
- C0-414 Bainbridge, C. (2009). About.com: Gifted children. *Extrinsic Motivation*. Retrieved on February 26, 2009, from <http://giftedkids.about.com/od/glossary/g/extrinsic.htm>
- C0-415 Bainbridge, C. (2009). About.com: Gifted children. *Intrinsic Motivation*. Retrieved on February 26, 2009, from <http://giftedkids.about.com/od/glossary/g/intrinsic.htm>

THIS PAGE INTENTIONALLY LEFT BLANK

EXTRINSIC MOTIVATORS

Extrinsic motivators refer to motivators that come from outside an individual. The motivating factors are external and are given as rewards. Rewards may include grades, stickers, trophies and badges.

Advantage

Extrinsically motivated people may work hard on a task even when they have little interest in the task. The extrinsically motivated person gets satisfaction because they will receive some kind of reward. These rewards provide satisfaction and pleasure that the task itself may not provide.

Disadvantage

The disadvantage to using extrinsic motivators is that these rewards only produce short-term results and a brief boost in morale. Over time, extrinsically motivated people are only satisfied when they receive some kind of reward.

List some examples of extrinsic motivators:

THIS PAGE INTENTIONALLY LEFT BLANK

INTRINSIC MOTIVATORS

Intrinsic motivators refer to motivators that come from inside an individual rather than from any external or outside reward.

Advantage

Motivation comes from the pleasure the person gets from the task itself, the sense of satisfaction in completing the task or a sense of satisfaction from working on the task. This means that no physical reward is required.

Disadvantage

Intrinsic motivation is a learned behaviour and it takes some time to develop. Some individuals will take longer to be motivated by their inner drives rather than physical rewards.

List some examples of intrinsic motivators:

THIS PAGE INTENTIONALLY LEFT BLANK

WHEN TEAM LEADERS MOTIVATE TEAM MEMBERS

The team leader must motivate team members. The skill of knowing when your team members need to be motivated will develop over time. As a team leader during Proficiency Level Four, it is important to motivate team members at every opportunity.

HOW TEAM LEADERS MOTIVATE TEAM MEMBERS

The team leader must motivate team members. The skill of knowing when your team members need to be motivated will develop over time. As a team leader during Proficiency Level Four, it is important to motivate team members at every opportunity.

HOW TEAM LEADERS MOTIVATE TEAM MEMBERS

One of the most common methods used to motivate team members is to use praise. Verbal praise is a very effective way to motivate team members.

Verbal praise may be used as positive feedback before, during and at the end of tasks. If possible, team leaders should praise team members in front of others as it makes team members feel valued.

Praising Effort and Perseverance During a Task

It is very important for team leaders to praise team members for their effort and perseverance during a task. Encouraging and caring about team members is an important aspect of being a leader.

Praising the use of Different Strategies During a Task

Team leaders should praise team members when they use different strategies to during a task. Creative thinking is an important tool for leaders.

Praising Improvement During a Task

When team members have completed a task before and they complete the task again more effectively or efficiently, praise should be given. Leaders and team members should always try to improve their performance.

Encouraging the Development of Knowledge and Skills

Team leaders should encourage team members when they learn something new. Everything new that a team member learns may be used at some point to assist the team.

Praising the Completion of a Task

When team members complete a task, praise should be given. It is important to recognize dedication shown in seeing a task through to completion.

Thanking Team Members for Their Endeavours

Team leaders should try to recognize each team member for their contribution in the completion of a task. Making team members feel special is a great way to win even more cooperation from the team.

Giving credit for the completion of tasks to the team rather than yourself

When team leaders are given credit for completing a task, they should ensure that credit is given also to the team members. Recognizing the team for their accomplishments boosts the team's morale.

THIS PAGE INTENTIONALLY LEFT BLANK



**COMMON TRAINING
PROFICIENCY LEVEL FOUR
INSTRUCTIONAL GUIDE**



SECTION 4

EO M403.04 – PROVIDE FEEDBACK TO TEAM MEMBERS

Total Time:

60 min

PREPARATION

PRE-LESSON INSTRUCTIONS

Resources needed for the delivery of this lesson are listed in the lesson specification located in A-CR-CCP-804/PG-001, *Proficiency Level Four Qualification Standard and Plan*, Chapter 4. Specific uses for said resources are identified throughout the instructional guide within the TP for which they are required.

Review the lesson content and become familiar with the material prior to delivering the lesson.

Photocopy the scenarios located at Attachment A. Cut out the scenarios and distribute one to each cadet. If there are more cadets than scenarios provided, multiple cadets may be given the same scenario.

Photocopy the Effective Feedback handout located at Attachment B for each cadet.

PRE-LESSON ASSIGNMENT

Nil.

APPROACH

An in-class activity was chosen for TPs 1 and 5 as an interactive way to provoke thought, and to stimulate an interest among cadets about feedback.

An interactive lecture was chosen for TPs 2–4 to orient the cadets to giving effective feedback.

INTRODUCTION

REVIEW

Review what “feedback” is. This is previously discussed in Proficiency Level Three and can be summarized as follows:

Feedback is a reactive form of communication. It is a response to some kind of action or input. Feedback may:

- answer a question;
- fulfill a request for information;
- reply to or rebut a point of discussion;

- suggest a revision during a task; or
- evaluate task or job performance.

OBJECTIVES

By the end of this lesson the cadet shall have provided feedback to team members.

IMPORTANCE

It is important for cadets to provide feedback because it is an essential skill for a team leader. Feedback is given to help team members improve. Providing feedback correctly to team members gives the team members regular guidance to complete their tasks.

Teaching Point 1**Have the cadets brainstorm and prepare a list of opportunities when feedback should be provided.**

Time: 5 min

Method: In-Class Activity

ACTIVITY**OBJECTIVE**

The objective of this activity is to have cadets brainstorm and prepare a list of opportunities when feedback should be provided.

RESOURCES

- Two flip charts, and
- Two markers.

ACTIVITY LAYOUT

Nil.

ACTIVITY INSTRUCTIONS

1. Divide the cadets into two groups.
2. Give each group a flip chart and marker.
3. Have each group brainstorm and record on the flip chart a list of opportunities when feedback should be provided.
4. Have one member of each group share their list with the class.

SAFETYNil

CONFIRMATION OF TEACHING POINT 1

The cadets' participation in the activity will serve as the confirmation of this TP.

Teaching Point 2**Explain the principles of effective feedback.**

Time: 10 min

Method: Interactive Lecture

PRINCIPLES OF EFFECTIVE FEEDBACK

Feedback may be given to the team as a whole or it may be given to individual team members. Giving feedback well is a skill. Feedback is a practical method for giving team members feedback, and when giving feedback, it should be frequent, accurate, specific, and timely.

Frequent. Frequent means occurring often or in close succession. Team leaders should give feedback often. After giving feedback, a team leader should note if the team members are responding. If the feedback is not being used by the team members, it may need to be restated in a different way.

Accurate. Accurate means careful, precise or lacking errors. Accurate feedback means giving feedback that is truthful and fact-based. Accurate feedback should be correct, balanced and appropriate; if not, team members may begin to lose respect for the team leader as every instance of feedback has an effect on the team members' trust.

Specific. Specific means clearly defined, definite or precise. Specific feedback means giving feedback that is detailed and clear-cut. Telling team members what they do right and wrong is not specific enough; the team leader must also tell team members exactly what steps are necessary to improve their performance. This is usually done by asking reflective questions to the team members so they generate suggestions for improvement. When giving specific feedback, team leaders should set concrete goals and deadlines for team members.

Timely. Timely means opportune, occurring, done or made at suitable or appropriate time. Timely feedback means giving feedback at the right time. The closer in time the feedback follows the performance, the more impact it will have on team members because the performance and the feedback are tied closely together.



Feedback must be based on the team member's behaviour and / or performance—not the person or their personality.



Ask cadets to give examples of when feedback has been given to them that was frequent, accurate, specific, and timely.

CONFIRMATION OF TEACHING POINT 2

QUESTIONS:

- Q1. What does frequent feedback mean?
- Q2. What does accurate feedback mean?
- Q3. What does specific feedback mean?
- Q4. What does timely feedback mean?

ANTICIPATED ANSWERS:

- A1. Frequent feedback means giving feedback to team members often.
- A2. Accurate feedback means giving feedback that is truthful and fact-based.
- A3. Specific feedback means giving feedback that is detailed and clear-cut.
- A4. Timely feedback means giving feedback at the right time.

Teaching Point 3**Explain the ground rules for providing feedback.**

Time: 10 min

Method: Interactive Lecture

GROUND RULES FOR PROVIDING FEEDBACK

The following ground rules for providing feedback may enable the team leader to give helpful, constructive feedback, without creating conflict or confrontational behaviour with team members.

Focusing on What is Observed

Team leaders should give feedback based on what they see because it is factual. What team leaders believe is based on supposition and inference; it is an interpretation of what they have seen. When team leaders give feedback based on interpretation rather than fact, the interpretation may be wrong.

For example:

A team member is looking at their boots as the team leader speaks to him. The team leader says "Pay attention." This is incorrect because the team leader is inferring that the team member is not paying attention. The team leader should say "You should be looking here." This statement focuses on what the team leader saw.

Focusing on Behaviour

Team leaders should give feedback based on the behaviour of team members, not on the person or personality of a team member.

For example:

A team leader observes a team member slouching against a wall. The team leader says "Don't be lazy." This is incorrect because the team leader is making judgment on the team member's personality. The team leader should say "Stand up straight." This statement does not make any judgment but focuses directly on the behaviour required by the team member.

Keeping it Neutral

Team leaders should give feedback that is unbiased and does not make judgments. When a team leader is objective when giving feedback, the team members can determine for themselves the effect of their behaviour. This presents a more meaningful learning opportunity for team members.

For example:

The team leader observes a team member arriving late again. The team leader says "You are late a lot." This is incorrect because the team leader has made a judgment on how many times the team member has been late. The team leader should say "You have been late three times in the past two months." This is a statement of fact.

Using it to Inform

Team leaders should give feedback that is enlightening and does not advise. When the team leader gives feedback, it leaves the team members free to draw their own conclusions. This freedom allows the team members to decide what actions are necessary to change their behaviour.

For example:

A team leader does an inspection and observes that a team member's boots are not up to standard. The team leader says "Everyone needs to work on their boots." The team leader should say "Our team's boots are not meeting inspection standard." This statement allows team members to decide what should be done.



If the team members cannot generate an idea, the team leader may have to explain what behaviour is required.

Making it Supportive

Team leaders should give feedback that is reassuring and not threatening. When the team leader gives feedback that is supportive, it does not sound like a put-down. The choice of language and tone must be carefully considered. Even the friendliest and best intentioned feedback can sound intimidating.

For example:

A team leader observes a team member leading a team-building activity. The team leader says "I want to talk to you about that activity." This may be perceived as frightful and ominous. The team leader should say "I thought your activity went well, but let's have a chat about making it even better." This statement starts with something positive and then offers and opportunity to discuss ways of improving.

Keeping it Simple

Team leaders should give feedback that is uncomplicated. Team members can usually only process one or two pieces of information at any one time. If team leaders overload team members with too much feedback, there is a possibility that the information will not be received. Feedback on one or two major points is more useful than feedback on six or seven minor points.

For example:

A team leader supervises as a team member conducts an inspection. The team leader notices that the team member's uniform and boots are not up to inspection standard. The team member starts the inspection at the cadet's back and continues to make errors. The team leader says "Very few things went correctly during that inspection—you look bad, you started with their backs and your comments made no sense." This is incorrect because the team leader is focusing on too many issues at once. The team leader should have said "Very few things went correctly during that inspection and we will start with your uniform." This allows the team member to focus on one behaviour at a time.

ACTIVITY

Time: 5 min

OBJECTIVE

The objective of this activity is to have the cadets identify the ground rules for providing feedback.

RESOURCES

Nil.

ACTIVITY LAYOUT

Nil.

ACTIVITY INSTRUCTIONS

1. Have the cadets find a partner.
2. Have the cadet with the earliest birthday recite one ground rule for providing feedback to their partner.

3. Have the cadet with the latest birthday recite another ground rule for providing feedback to their partner.
4. Have the cadets take turns reciting the ground rules for providing feedback until all the ground rules have been recited.

SAFETY

Nil.

CONFIRMATION OF TEACHING POINT 3

The cadets' participation in the activity will serve as the confirmation of this TP.

Teaching Point 4

Explain the steps for providing and receiving feedback.

Time: 10 min

Method: Interactive Lecture

STEPS FOR PROVIDING FEEDBACK

The purpose for providing feedback is to let team members know how they are doing and when they are not meeting expectations. Team leaders should ensure that feedback is given when team members meet and / or exceed their commitments, as well as when team members do not meet their commitments. There are five steps for providing feedback.

Planning What to Say. Team leaders need to plan what they will say during feedback using the ground rules for providing feedback. Team leaders should think ahead of time about the team member's behaviour to be discussed. Team leaders should also have suggestions for improvement; however, these ideas should only be given if the team member cannot generate suggestions for improvement themselves.

Providing Examples of Behaviours. Team leaders need to give feedback that provides examples of the behaviour that needs to change. Giving unclear or vague examples may lead to anxiety in team members because they are not sure what behaviour needs to be modified.

Allowing Time for Feedback. Once team leaders have provided examples to the team members, they should allow time for discussion. The team members may agree, disagree or provide their perspective of the situation to the team leader. The team members may need to ask for clarification of the behaviours or they may ask for suggestions to assist them in changing their behaviour.

Motivating. Once team leaders have allowed time for discussion of the feedback, team leaders should motivate the team members. The team member may be disappointed by the feedback so the team leader should encourage and stimulate them to reach their goals.

Setting a Timeline for Action and Follow-Up. Team leaders need to set a timeframe for action by the team member to check for progress on the behaviour change. Team leaders need to follow up to ensure the team members are making the corrections required.

RECEIVING FEEDBACK

In every feedback session, there must be a sender and a receiver. When receiving feedback, there are five considerations.

Seeing Each Feedback Session as a Learning Opportunity. Each time feedback is received, the feedback session should be seen as a learning opportunity because ideas are generated on how to improve performance. Whether the idea comes from the receiver or the sender, acting on suggestions usually leads to developing skills and knowledge.

Actively Listening to the Sender's Ideas. Active listening encourages the sender to present their feedback in a non-threatening environment. Active listening on the part of the receiver shows the sender that their feedback is important.

Asking for More Information if the Ideas are Not Understood. When the sender gives feedback and the ideas are not understood, the receiver should ask for more information. By asking questions for clarification, the receiver should be able to understand the sender's intent.

Being Honest About How the Feedback is Affecting One's Emotions. Receiving feedback can make the receiver feel uncomfortable. The receiver should be honest with the sender about how the feedback is affecting them. As the receiver, try not to get emotional or take the feedback personally.

Remaining Open-Minded About Future Learning Opportunities. It is important to be open-minded about future feedback. Senders may follow up on their feedback and may even provide even more feedback. The receiver should be aware of these future learning opportunities.

CONFIRMATION OF TEACHING POINT 4

QUESTIONS:

- Q1. State two of the five steps for providing feedback.
- Q2. State two of the five considerations for receiving feedback.

ANTICIPATED ANSWERS:

- A1. Planning what to say; providing examples of behaviours; allowing time for feedback; motivating; and setting a timeline for action and follow-up.
- A2. Seeing each feedback session as a learning opportunity; actively listening to the sender's ideas; asking for more information if the ideas are not understood; being honest about how the feedback is affecting one's emotions; and remaining open-minded about future learning opportunities.

Teaching Point 5

Using scenarios, have the cadets practice providing feedback to team members.

Time: 15 min

Method: In-Class Activity

ACTIVITY

OBJECTIVE

The objective of this activity is to have cadets practice providing feedback to team members.

RESOURCES



If there are more cadets than scenarios provided, multiple cadets may be given the same scenario.

Scenarios located at Attachment A.

ACTIVITY LAYOUT

Nil.

ACTIVITY INSTRUCTIONS

To give each cadet an equal opportunity to give feedback, divide the time equally between the number of cadets in the group.

1. Distribute a scenario to each cadet.
2. Give the cadets one minute to read the scenario and make notes on the feedback they wish to give. Ensure the cadets know the length of time they have to give feedback.
3. Ask for a volunteer to give their feedback.
4. Have the volunteer read their scenario and then give their feedback.
5. Repeat Steps 3 and 4 until all cadets have given their feedback.

SAFETY

Nil.

CONFIRMATION OF TEACHING POINT 5

The cadets' participation in the activity will serve as the confirmation of this TP.

END OF LESSON CONFIRMATION

The cadets' participation in the feedback activity will serve as the confirmation of this lesson.



Distribute the Effective Feedback handout located at Attachment B to each cadet.

CONCLUSION**HOMEWORK / READING / PRACTICE**

Nil.

METHOD OF EVALUATION

This EO is assessed IAW A-CR-CCP-804/PG-001, *Proficiency Level Four Qualification Standard and Plan*, Chapter 3, Annex B, 403 PC.

CLOSING STATEMENT

Providing feedback is an essential skill for a team leader. Feedback is given to help team members improve. Providing feedback correctly to team members gives the team members regular guidance to complete their tasks.

INSTRUCTOR NOTES / REMARKS

Nil.

REFERENCES

C0-258 ISBN 978-1-59869-450-5 Nigro, N. (2008). *The everything coaching and mentoring book*. (2nd ed.). Avon, MA: F+W Publications Company.

C0-403 Peeling, G. (2000). *Feedback techniques: 7 things to know about giving feedback: Trainers Guide*. Cambridgeshire, England: Fenman Limited.

C0-404 Mochal, T. (2006). *Follow these six steps when providing constructive performance feedback*. Retrieved February 5, 2009, from http://articles.techrepublic.com.com/5100-10878_11-6102736.html

C0-412 ISBN 978-0-87425-495-2 Tulgan, B. (1999). *Fast feedback* (2nd ed). Amherst, MA: HRD Press, Inc.

SCENARIOS FOR PROVIDING FEEDBACK

SCENARIO #1

One of your team members has not displayed a positive attitude toward the last three tasks assigned to him. He is complaining about having to do any work at all. His outlook is having a negative effect on the team. He is a second year cadet and wishes to go to summer training this summer.

SCENARIO #2

One of your team members has not worn her uniform to cadets twice this month. When she has worn her uniform, it has not been up to inspection standards. She is a first year cadet and does very well in her classes.

SCENARIO #3

One of your team members was tasked with setting up and tearing down a classroom for a staff meeting. He completed the task but was 10 minutes late for the set-up and 5 minutes late for the tear-down. He is always asking to be given more duties.

SCENARIO #4

One of your team members was absent from the last three parade nights and did not call to explain his absence. He is at cadets this evening. He is a first year cadet and wishes to go to summer training this summer.

SCENARIO #5

One of your team members has been late coming to class after break the last three weeks in a row. He is a volunteer at the canteen.

SCENARIO #6

One of your team members was tasked to clean up a classroom. This task was not accomplished. She is a third year cadet.

SCENARIO #7

One of your team member's hair does not meet the standard. Her hair is on her shoulders. Her uniform and boots do meet the standard.

SCENARIO #8

One of your team members has been accomplishing all tasks assigned. He has been to every parade night and volunteers for all cadet activities. He is a second year cadet and wishes to go to summer training this summer.

SCENARIO #9

One of your team members has been accomplishing three quarters of the tasks assigned. She has been to all parade nights except two. She volunteers for nearly all cadet activities. She is a second year cadet and wishes to go to summer training this summer.

SCENARIO #10

One of your team members has been accomplishing all tasks assigned and is very enthusiastic while doing them. He has been to all parade nights except two. He volunteers for nearly all cadet activities. He is a first year cadet and wishes to go to summer training this summer.

THIS PAGE INTENTIONALLY LEFT BLANK

EFFECTIVE FEEDBACK

PRINCIPLES OF EFFECTIVE FEEDBACK

Feedback is a reactive form of communication. It is a response to some kind of action or input. Feedback may:

- answer a question;
- fulfill a request for information;
- reply to or rebut a point of discussion;
- suggest a revision during a task; or
- evaluate task or job performance.

Feedback may be given to the team as a whole or it may be given to individual team members. Giving feedback well is a skill. Feedback is a practical method for giving team members feedback, and when giving feedback, it should be frequent, accurate, specific, and timely.

Frequent. Frequent means occurring often or in close succession. Team leaders should give feedback often. After giving feedback, a team leader should note if the team members are responding. If the feedback is not being used by the team members, it may need to be restated in a different way.

Accurate. Accurate means careful, precise or lacking errors. Accurate feedback means giving feedback that is truthful and fact-based. Accurate feedback should be correct, balanced and appropriate; if not, team members may begin to lose respect for the team leader as every instance of feedback has an effect on the team members' trust.

Specific. Specific means clearly defined, definite or precise. Specific feedback means giving feedback that is detailed and clear-cut. Telling team members what they do right and wrong is not specific enough; the team leader must also tell team members exactly what steps are necessary to improve their performance. This is usually done by asking reflective questions to the team members so they generate suggestions for improvement. When giving specific feedback, team leaders should set concrete goals and deadlines for team members.

Timely. Timely means opportune, occurring, done or made at suitable or appropriate time. Timely feedback means giving feedback at the right time. The closer in time the feedback follows the performance, the more impact it will have on team members because the performance and the feedback are tied closely together.

GROUND RULES FOR PROVIDING FEEDBACK

The following ground rules for providing feedback may enable the team leader to give helpful, constructive feedback, without creating conflict or confrontational behaviour with team members.

Focusing on What is Observed

Team leaders should give feedback based on what they see because it is factual. What team leaders believe is based on supposition and inference; it is an interpretation of what they have seen. When team leaders give feedback based on interpretation rather than fact, the interpretation may be wrong.

Focusing on Behaviour

Team leaders should give feedback based on the behaviour of team members, not on the person or personality of a team member.

Keeping it Neutral

Team leaders should give feedback that is unbiased and does not make judgments. When a team leader is objective when giving feedback, the team members can determine for themselves the effect of their behaviour. This presents a more meaningful learning opportunity for team members.

Using it to Inform

Team leaders should give feedback that is enlightening and does not advise. When the team leader gives feedback, it leaves the team members free to draw their own conclusions. This freedom allows the team members to decide what actions are necessary to change their behaviour.

Making it Supportive

Team leaders should give feedback that is reassuring and not threatening. When the team leader gives feedback that is supportive, it does not sound like a put-down. The choice of language and tone must be carefully considered. Even the friendliest and best intentioned feedback can sound intimidating.

Keeping it Simple

Team leaders should give feedback that is uncomplicated. Team members can usually only process one or two pieces of information at any one time. If team leaders overload team members with too much feedback, there is a possibility that the information will not be received. Feedback on one or two major points is more useful than feedback on six or seven minor points.

STEPS FOR PROVIDING FEEDBACK

The purpose for providing feedback is to let team members know how they are doing and when they are not meeting expectations. Team leaders should ensure that feedback is given when team members meet and / or exceed their commitments, as well as when team members do not meet their commitments. There are five steps for providing feedback.

Planning What to Say. Team leaders need to plan what they will say during feedback using the ground rules for providing feedback. Team leaders should think ahead of time about the team member's behaviour to be discussed. Team leaders should also have suggestions for improvement; however, these ideas should only be given if the team member cannot generate suggestions for improvement themselves.

Providing Examples of Behaviours. Team leaders need to give feedback that provides examples of the behaviour that needs to change. Giving unclear or vague examples may lead to anxiety in team members because they are not sure what behaviour needs to be modified.

Allowing Time for Feedback. Once team leaders have provided examples to the team members, they should allow time for discussion. The team members may agree, disagree or provide their perspective of the situation to the team leader. The team members may need to ask for clarification of the behaviours or they may ask for suggestions to assist them in changing their behaviour.

Motivating. Once team leaders have allowed time for discussion of the feedback, team leaders should motivate the team members. The team member may be disappointed by the feedback so the team leader should encourage and stimulate them to reach their goals.

Setting a Timeline for Action and Follow-Up. Team leaders need to set a timeframe for action by the team member to check for progress on the behaviour change. Team leaders need to follow up to ensure the team members are making the corrections required.

RECEIVING FEEDBACK

In every feedback session, there must be a sender and a receiver. When receiving feedback, there are five considerations.

Seeing Each Feedback Session as a Learning Opportunity. Each time feedback is received, the feedback session should be seen as a learning opportunity because ideas are generated on how to improve performance. Whether the idea comes from the receiver or the sender, acting on suggestions usually leads to developing skills and knowledge.

Actively Listening to the Sender's Ideas. Active listening encourages the sender to present their feedback in a non-threatening environment. Active listening on the part of the receiver shows the sender that their feedback is important.

Asking for More Information if the Ideas are Not Understood. When the sender gives feedback and the ideas are not understood, the receiver should ask for more information. By asking questions for clarification, the receiver should be able to understand the sender's intent.

Being Honest About How the Feedback is Affecting One's Emotions. Receiving feedback can make the receiver feel uncomfortable. The receiver should be honest with the sender about how the feedback is affecting them. As the receiver, try not to get emotional or take the feedback personally.

Remaining Open-Minded About Future Learning Opportunities. It is important to be open-minded about future feedback. Senders may follow up on their feedback and may even provide even more feedback. The receiver should be aware of these future learning opportunities.

THIS PAGE INTENTIONALLY LEFT BLANK



**COMMON TRAINING
PROFICIENCY LEVEL FOUR
INSTRUCTIONAL GUIDE**



SECTION 5

EO M403.05 – PARTICIPATE IN A MENTORING RELATIONSHIP

Total Time:

60 min

PREPARATION

PRE-LESSON INSTRUCTIONS

Resources needed for the delivery of this lesson are listed in the lesson specification located in A-CR-CCP-804/PG-001, *Proficiency Level Four Qualification Standard and Plan*, Chapter 4. Specific uses for said resources are identified throughout the instructional guide within the TP for which they are required.

Review the lesson content and become familiar with the material prior to delivering the lesson.

Photocopy the scenario located at Attachment B for half the cadets in the class.

Photocopy the scenario located at Attachment C for half the cadets in the class.

PRE-LESSON ASSIGNMENT

Nil.

APPROACH

An interactive lecture was chosen for TPs 1 and 3 to review the mentoring relationship and to orient the cadets to the steps in a mentoring session.

A group discussion was chosen for TP 2 as it allows the cadets to interact with their peers and share knowledge, experiences, opinions and feeling about formal and informal mentoring.

A demonstration was chosen for TP 4 as it allows the instructor to explain and demonstrate a mentoring session.

A role-play was chosen for TP 5 as it provides the cadets an opportunity to view and then conduct a mentoring session under supervision.

INTRODUCTION

REVIEW

Nil.

OBJECTIVES

By the end of this lesson the cadet shall have participated in a mentoring relationship.

IMPORTANCE

It is important for cadets to participate in a mentoring relationship to assist in the development of their leadership abilities. The mentoring relationship provides an opportunity to expand leadership knowledge and skills of participants, enhances communication skills, resolves conflict and promotes constructive feedback, and should aid in leadership development.

Teaching Point 1**Review the mentoring relationship.**

Time: 5 min

Method: Interactive Lecture

THE MENTORING RELATIONSHIP

A mentoring relationship is an association between two people that focuses on self-development. One is the mentor; the other is the cadet being mentored. Both individuals are expected to learn from the relationship.

Recognizing the Purpose of a Mentoring Relationship

The purpose of the mentoring relationship is to share experiences between the mentor and the cadet being mentored, so the cadet being mentored is better prepared to move forward through the program with knowledge and confidence.

Identifying the Benefits of Participating in a Mentoring Relationship

The most significant benefit for the mentor is the realization that they have inspired the cadet to perform at higher levels than the cadet would have without a mentor. The basic benefit for a cadet being mentored is to show growth in skills and become a more independent and effective cadet.

Contributing to a Mentoring Match

Both the mentor and the cadet being mentored will have input with whom they are matched. The mentoring relationship is based on trust; ensure a long-term and valuable connection can be made with the person chosen.

Being Open to New Things

For a mentoring relationship to be successful, both individuals must be willing to try new things. Expanding boundaries and increasing knowledge are foundations of the mentoring relationship. Being receptive to new ideas and experiences takes courage.

Being Responsive to Suggestions and Constructive Criticism

The mentor should use constructive criticism and attempt to provide feedback that will assist the cadet being mentored. The task of the cadet being mentored is to be receptive to recommendations being made.

Providing Feedback to the Mentor

It is important that the cadet being mentored provides feedback to the mentor. This feedback should be based on feelings, both positive and negative, and observations. If the cadet being mentored does not express feelings to the mentor about the relationship, then progress may be hindered.

Learning From the Mentor's Example

It is up to the mentor to set an example that the cadet being mentored would want to emulate. This example should be in all facets of the program. The cadet being mentored should learn not only from the mentor's successes but from the mentor's failures.

Participating in Mentoring Activities

The cadet being mentored must be prepared to participate in mentoring activities. These activities may include reflection, self-assessment, and discussions about successes, problems and failures. The mentor must also be prepared for each mentoring session. They need to have an agenda or plan of what will be discussed and ensure that the discussions stay on track.

Appreciating the Mentoring Relationship

An effective mentoring relationship must be respected by both people involved. Each person should have a high regard for the other in the relationship. Appreciating the other person for their effort, time and accomplishments can help ensure a long-lasting and mutually beneficial partnership.

CONFIRMATION OF TEACHING POINT 1

QUESTIONS:

- Q1. What is the basic benefit of a mentoring relationship for the cadet being mentored?
- Q2. What are the foundations of a mentoring relationship?
- Q3. What are some examples of mentoring activities?

ANTICIPATED ANSWERS:

- A1. The basic benefit is that the cadet being mentored will grow in their skills and become a more independent cadet.
- A2. Expanding boundaries and increasing knowledge are foundations of the mentoring relationship.
- A3. Mentoring activities may include reflection, self-assessment, and discussions about successes, problems and failures.

Teaching Point 2

Discuss the difference between formal and informal mentoring.

Time: 5 min

Method: Group Discussion

BACKGROUND KNOWLEDGE



The purpose of the group discussion is to draw the following information from the group using the tips for answering / facilitating discussion and the suggested questions provided.

FORMAL MENTORING

Formal mentoring is a process where the mentor and cadet being mentored have regular meetings to discuss feedback. By the end of each meeting, expectations for the participants are agreed to. Usually, formal mentoring has specific goals such as the transfer of knowledge from the mentor to the cadet being mentored and developing the mentored cadet's leadership skills.

INFORMAL MENTORING

Informal mentoring is a practice where the mentor and the cadet being mentored discuss feedback. Informal mentoring is similar to teaching / coaching on the spot. There are no specific meetings during informal mentoring. The dialogue between the mentor and the cadet being mentored takes place as soon as possible after the activity or task.

GROUP DISCUSSION



TIPS FOR ANSWERING / FACILITATING DISCUSSION:

- Establish ground rules for discussion, eg, everyone should listen respectfully; don't interrupt; only one person speaks at a time; no one's ideas should be made fun of; you can disagree with ideas but not with the person; try to understand others as much as you hope they understand you; etc.
- Sit the group in a circle, making sure all cadets can be seen by everyone else.
- Ask questions that will provoke thought; in other words avoid questions with yes or no answers.
- Manage time by ensuring the cadets stay on topic.
- Listen and respond in a way that indicates you have heard and understood the cadet. This can be done by paraphrasing their ideas.
- Give the cadets time to respond to your questions.
- Ensure every cadet has an opportunity to participate. One option is to go around the group and have each cadet answer the question with a short answer. Cadets must also have the option to pass if they wish.
- Additional questions should be prepared ahead of time.

SUGGESTED QUESTIONS:

- Q1. Do you feel there is a difference between formal and informal mentoring? What is the difference?
- Q2. Which do you feel would be more appropriate for you? Why?
- Q3. Is formal or informal mentoring used more often within the Cadet Program? Give some examples of formal mentoring you have seen. Give some examples of informal mentoring you have seen.



Other questions and answers will develop throughout the group discussion. The group discussion should not be limited to only those suggested.



Reinforce those answers given and comments made during the group discussion, ensuring the teaching point has been covered.

CONFIRMATION OF TEACHING POINT 2

The cadets' participation in the group discussion will serve as the confirmation for this TP.

Teaching Point 3**Describe the steps of a formal mentoring session.**

Time: 10 min

Method: Interactive Lecture



When a cadet mentors another individual, the cadet contributes to the social competence and cognitive competence participant outcomes of the Cadet Program as listed in CATO 11-03, *Cadet Program Mandate*.

STEPS OF A FORMAL MENTORING SESSION

Mentoring is results-oriented. The mentor and the cadet being mentored must see results for the mentoring sessions to be considered successful.



Mentoring is based on three Ps: people, performance and positive outcomes.

A formal mentoring session has four steps:

1. **Getting acquainted.** The initial mentoring session must have an introduction where both the mentor and the cadet who is being mentored provide a few details about themselves. This step should allow both participants to establish a bond of trust.



Active listening is the most important skill of a good mentor. Active listening demands that the listener put aside any internal reactions and turn their attention to the speaker without judging what is being said.

2. **Setting goals.** During this step, goals are established. Work must be done to ensure the goals are specific, measurable, achievable, relevant, and timed. These goals should be in writing.
3. **Meeting goals and expectations.** During this step, the cadet being mentored must describe how they are going to meet the goals just set. In subsequent mentoring sessions, the cadet being mentored should be praised for achieving goals but may need to account for why the goals and expectations were not met.
4. **Concluding the mentoring session.** This conclusion should begin with the cadet being mentored giving a short explanation of new goals to be met and how the cadet plans to achieve them. The mentor should encourage the cadet being mentored and arrange the time and date for the next mentoring session.

CONFIRMATION OF TEACHING POINT 3**QUESTIONS:**

- Q1. What are the three Ps of mentoring?
- Q2. What is the most important skill for a mentor?
- Q3. What are the four steps of a formal mentoring session?

ANTICIPATED ANSWERS:

- A1. The three Ps of mentoring are people, performance and positive outcomes.
- A2. The most important skill for a mentor is active listening.
- A3. The four steps of a formal mentoring session are:
1. getting acquainted;
 2. setting goals;
 3. meeting goals and expectations; and
 4. concluding the mentoring session.

Teaching Point 4**Demonstrate and explain a mentoring session.**

Time: 10 min

Method: Demonstration



Present the following information before demonstrating a mentoring session.

Successful mentoring is based on the quality of the relationship between both participants. Trust is a basic ingredient to this relationship. The mentor must build and maintain trust by:

- keeping the mentoring relationship professional;
- keeping the conversation during the mentoring session in confidence; and
- using the ground rules for feedback during a mentoring session.

KEEPING THE MENTORING RELATIONSHIP PROFESSIONAL

Mentors must maintain a professional relationship with the cadet being mentored. The position of mentor can be rewarding but comes with inherent risks. Mentors need to remember that they are in a position of authority and must use their authority wisely. Mentors may deal with the cadets being mentored in a friendly manner; however, mentors cannot be their friends.

KEEPING THE CONVERSATION DURING THE MENTORING SESSION IN CONFIDENCE

The mentor and the cadet being mentored should keep the conversation between them in confidence. The dialogue should be kept private to avoid embarrassment by either participant.

USING THE GROUND RULES FOR FEEDBACK DURING A MENTORING SESSION

The mentor should use the ground rules for feedback during a mentoring session. It is important to provide feedback during a mentoring session correctly by:

- focusing on what is observed;
- focusing on behaviour;
- keeping it neutral;

- using it to inform;
- making it supportive; and
- keeping it simple.



This demonstration should be conducted as a role-play, where the instructor is the mentor and a cadet from the group is the cadet being mentored. Begin the demonstration by reading the scenario located at Attachment A to the cadets. Then begin introducing the remaining information in this TP while demonstrating a mentoring session.

One of the duties of a team leader is to mentor cadets. The format for a mentoring session is done using the following sequence:

1. The mentor and the cadet being mentored will sit across from each other and begin the session by introducing themselves.
2. The mentor and the cadet being mentored must set goals if goals have not been set.
3. If the goals have been set, the mentor will review the goals and expectations and ask the cadet being mentored how they are meeting those goals and expectations. The cadet being mentored is required to use self-reflection during this review stage.



This review stage should be done by asking various questions such as:

- How do you think things are going for you?
- Do you think you have areas that need improvement?
- What areas would you like to see improvement?
- How do you think you can improve in those areas?

If the cadet being mentored has no ideas on how to improve, then suggestions by the mentor may be given.

4. Before leaving the mentoring session, the cadet being mentored must be able to explain to the mentor their plan to keep old goals or set new goals. The mentor should encourage the cadet being mentored and arrange the time and date for the next mentoring session.



Planning to keep old goals or set new goals may be done by asking various questions such as:

- What are your long-term goals?
- What are you going to do to meet your long-term goals?

If the cadet being mentored has no ideas on how to keep old goals or set new goals, then suggestions by the mentor may be given.

CONFIRMATION OF TEACHING POINT 4**QUESTIONS:**

- Q1. How does a mentor build trust with the cadet being mentored?
- Q2. Did the mentoring session go well? Why or why not?
- Q3. Give some examples of how the mentor used active listening skills?

ANTICIPATED ANSWERS:

- A1. The mentor builds trust by:
- keeping the mentoring relationship professional;
 - keeping the conversation during the mentoring session in confidence; and
 - using the ground rules for feedback during a mentoring session.
- A2. Answers will vary.
- A3. Answers will vary.

Teaching Point 5

Have the cadets role-play a mentoring session based on two given scenarios.

Time: 20 min

Method: Role-play



The scenarios for the role-play activity are located at Attachment B for Scenario 1 and Attachment C for Scenario 2.

ACTIVITY**OBJECTIVE**

The objective of this activity is to have the cadets role-play a mentoring session based on given scenarios.

RESOURCES

Scenarios located at Attachments B and C.

ACTIVITY LAYOUT

Nil.

ACTIVITY INSTRUCTIONS

1. Divide the cadets into pairs.
2. Distribute Attachment B to one cadet in each pair.
3. Distribute Attachment C to the other cadet in each pair.

4. Designate one cadet as the mentor and the other cadet as the cadet to be mentored in each pair.
5. Supervise while one cadet mentors another cadet by:
 - a. getting acquainted;
 - b. setting goals;
 - c. meeting goals and expectations; and
 - d. concluding the mentoring session.
6. After approximately 10 minutes have the cadets change roles.
7. Repeat Steps 4 and 5 for approximately 10 minutes.

SAFETY

Nil.

CONFIRMATION OF TEACHING POINT 5

The cadets' participation in the activity will serve as the confirmation for this TP.

END OF LESSON CONFIRMATION

The cadets' participation in the role-play will serve as the confirmation for this lesson.

CONCLUSION

HOMEWORK / READING / PRACTICE

Nil.

METHOD OF EVALUATION

Nil.

CLOSING STATEMENT

Being mentored and mentoring others is one way to enhance skills and knowledge of leadership. The mentoring relationship develops trust and trust is the foundation of leadership. The mentoring relationship provides an opportunity to expand leadership knowledge and skills, enhances communication skills, resolves conflict and promotes constructive feedback.

INSTRUCTOR NOTES / REMARKS

Cadets will have opportunities to participate in formal and informal mentoring relationships through the training year. A cadet in Proficiency Level Four is in a position to both mentor a subordinate cadet and be mentored by a more senior cadet and / or adult staff member.

REFERENCES

C0-258 ISBN 978-1-59869-450-5 Nigro, N. (2008). *The everything coaching and mentoring book*. (2nd ed.). Avon, MA: F+W Publications Company.

C0-324 Taylor, J. S. (2003). *Training new mentees: A manual for preparing youth in mentoring programs*. USA: The National Mentoring Center.

C0-405 ISBN 0-7879-6294-5 Rhodes, J. (2002). *New directions for youth development: A critical view of youth mentoring*. New York, NY: Jossey-Bass.

THIS PAGE INTENTIONALLY LEFT BLANK

SCENARIO FOR THE MENTORING DEMONSTRATION

The cadet being mentored is in the second year of training. The cadet is still having problems with wearing their uniform. The cadet being mentored is quite shy and does not like to ask for assistance. The cadet being mentored has set a goal of attending the Basic Leadership course for the summer.

THIS PAGE INTENTIONALLY LEFT BLANK

SCENARIO 1 FOR THE ROLE-PLAY ACTIVITY

The cadet being mentored is in their first year of training. They are having problems attending training nights each week. They have missed three of the last six training nights. The cadet being mentored is quite confident and when they attend training nights, their uniform and boots exceed inspection standard. The cadet being mentored has set a goal of attending the General Training course for the summer.

THIS PAGE INTENTIONALLY LEFT BLANK

SCENARIO 2 FOR THE ROLE-PLAY ACTIVITY

The cadet being mentored is in their second year of training. The cadet always talks while on parade and during classes and is disruptive to other members of the class. The cadet being mentored is sometimes defensive when correction is given to them. The cadet being mentored has set a goal of attending the Basic Fitness and Sports course for the summer.

THIS PAGE INTENTIONALLY LEFT BLANK



**COMMON TRAINING
PROFICIENCY LEVEL FOUR
INSTRUCTIONAL GUIDE**



SECTION 6

EO M403.06 – ACT AS A TEAM LEADER DURING A LEADERSHIP APPOINTMENT

Total Time:	30 min
-------------	--------

PREPARATION

PRE-LESSON INSTRUCTIONS

Resources needed for the delivery of this lesson are listed in the lesson specification located in A-CR-CCP-804/PG-001, *Proficiency Level Four Qualification Standard and Plan*, Chapter 4. Specific uses for said resources are identified throughout the instructional guide within the TP for which they are required.

Review the lesson content and become familiar with the material prior to delivering the lesson.

Acquire the list of leadership appointments developed by the Training Officer.

Photocopy the Leadership Appointment Aide-Memoire located at Attachment B for each cadet.

PRE-LESSON ASSIGNMENT

Nil.

APPROACH

An interactive lecture was chosen for this lesson to orient the cadets to the leadership appointment.

INTRODUCTION

REVIEW

Nil.

OBJECTIVES

By the end of this lesson the cadet shall be expected to act as a team leader during a leadership appointment.

IMPORTANCE

It is important for cadets to understand the concept of and steps involved in successfully completing a leadership appointment. All cadets will be assessed during a leadership appointment in Proficiency Level Four. When appointed in their given role, each cadet must know the expectations for successful completion. An effective team leader will merge together what has been learned throughout previous leadership training and practice, including problem solving and supervision.

Teaching Point 1**Describe a leadership assignment and a leadership appointment.**

Time: 5 min

Method: Interactive Lecture

LEADERSHIP ASSIGNMENT

A leadership assignment is a specific, short- or long-term practical leadership opportunity during which the team leader must apply their leadership skills. The team leader will have temporary team members either within or outside their peer group for whom they will be responsible. The team will accomplish a singular minor duty or task.



Leadership assignments in Proficiency Level Four (PL4) may be the same as PL3. Each PL4 cadet has already completed at least two leadership assignments during their third year of training.

LEADERSHIP APPOINTMENT

A leadership appointment is a specific long-term practical leadership opportunity that is more comprehensive in nature than a leadership assignment. The team leader must apply their leadership knowledge and skills and display the core leadership qualities of a cadet. The team leader will have an assigned, established team of cadets outside their peer group. The team will accomplish a singular major duty or task. These may be organizational appointments (eg, Flight Sergeant, Squadron Commander, etc.), training appointments (eg, Proficiency Level Instructor, Leadership and Ceremonial Instructor, etc.) or supplementary appointments (eg, Canteen Steward, Drill Team Commander, etc.). In generating leadership appointments, consideration must be given to the duration of the major duty or task and frequency of opportunities to exercise leadership. The team leader is expected to meet with their team on a number of occasions over a period of time. Leadership appointments may be held by a single PL4 cadet (eg, Drill Team Commander) or the PL4 cadets may rotate through a position (eg, Canteen Steward). If a PL4 cadet rotates through a leadership appointment, the appointment must be meaningful for the cadet and be of a duration that allows the cadet to meet the objectives of applying their leadership knowledge and skills and displaying the core leadership qualities of a cadet.

The team leader must supervise team members, communicate with team members to solve problems, strive to meet the needs and expectations of team members, motivate team members, and provide feedback to team members. The team leader must attempt to develop the skills and knowledge of their team members.

Direction for the leadership appointment must be given by a superior, usually an activity leader or activity manager.



During PL4 training, each cadet will be assessed at least once on a leadership assignment and once on a leadership appointment.

CONFIRMATION OF TEACHING POINT 1

QUESTIONS:

- Q1. What kind of team will the team leader have during a leadership appointment?
- Q2. How many leadership assignments will be assessed in PL4 training?
- Q3. How many leadership appointments will be assessed in PL4 training?

ANTICIPATED ANSWERS:

- A1. During a leadership appointment, the team leader will have an assigned, established team of cadets outside their peer group.
- A2. At least one leadership assignment will be assessed in PL4 training.
- A3. One leadership appointment will be assessed in PL4 training.

Teaching Point 2

Describe the leadership appointments that may be assigned at the squadron.

Time: 5 min

Method: Interactive Lecture



Acquire the list of leadership appointments developed by the Training Officer before instructing this class. A list of possible Proficiency Level Four leadership assignments and appointments is located at Attachment A.

SAMPLE YEAR FOUR LEADERSHIP APPOINTMENTS

Organizational Appointments

- Flight Sergeant,
- Flight Commander,
- Squadron Commander,
- Drum Major, and
- Flag Party Commander.

Training Appointments

- Proficiency Level Instructor,
- Aviation Subjects Instructor,
- Leadership and Ceremonial Instructor,
- Fitness and Sports and Instructor,
- Air Rifle Marksmanship Instructor,

- Survival Instructor, and
- Band Section Leader.

Supplementary Appointments

- Supply Assistant,
- Administration Assistant,
- Training Assistant,
- Canteen Steward,
- Drill Team Commander,
- Marksmanship Team Captain,
- Range Assistant,
- First Aid Team Captain,
- Biathlon Team Captain, and
- Sports Team Captain.

CONFIRMATION OF TEACHING POINT 2

QUESTIONS:

Q1. What leadership appointments are available at the squadron?

ANTICIPATED ANSWERS:

A1. Answers will vary.

Teaching Point 3

Describe how to conduct the leadership appointment.

Time: 15 min

Method: Interactive Lecture



Each cadet has led a team through at least two leadership assignments; the steps for a leadership appointment are very similar.

When conducting the leadership appointment, use the following steps:

1. prepare for the leadership appointment;
2. brief the team members at the onset and then throughout the leadership appointment;
3. carry out the tasks associated with the leadership appointment;

4. provide feedback to the team members throughout and at the completion of the leadership appointment; and
5. meet with the activity manager throughout and at the completion of the leadership appointment to discuss the outcomes of the leadership appointment.

PREPARING FOR THE LEADERSHIP APPOINTMENT

Ensuring the Required Resources are Available

Make sure all the resources necessary for using during the appointment are available. For example, if the appointment is to act as a flag party commander, the flags, poles, etc will need to be available, both for practice and performance opportunities.

Completing a Time Appreciation

Be aware of the end date of the appointment. If the appointment is comprised of stages or phases, the leader must determine how much time to allocate to each stage or phase. All members involved in the appointment must be aware of the current date and the end date of the appointment.

Making a Plan

Make a plan to be successful in the appointment by:

1. determining what stages or phases comprise the appointment;
2. determining tasks inherent within the appointment;
3. developing a process to accomplish all tasks; and
4. identifying and allocating resources.

BRIEFING TEAM MEMBERS DURING THE LEADERSHIP APPOINTMENT

Communicating the Overall Plan

Explain how the appointment will be carried out. All team members should know what is involved as the leader carries out the appointment. This may include identifying various stages and phases.

Communicating the Tasks Involved in the Leadership Appointment

Explain the tasks involved within the leadership appointment. Leadership appointments may be comprised of a series of tasks.

Assigning Tasks to Team Members as Applicable

Assign each team member the tasks that must be completed within the scope of the appointment. Every team member should be actively engaged in a meaningful activity.

Ensuring the Team Members Understand Their Tasks

Confirm the team members understand their tasks and ask the team members if they have any questions. The team leader should also ask a few questions to various team members to ensure comprehension. When team members are assigned specific tasks, it is important they understand what is expected of them.

CARRYING OUT THE TASKS ASSOCIATED WITH THE LEADERSHIP APPOINTMENT

Supervising Team Members

Throughout the leadership appointment, the team leader will have many occasions during which to supervise team members. The most important aspect of supervision is to ensure the tasks are being conducted safely. Supervision also allows the team leader to provide ongoing feedback to team members.

Ensuring the Tasks Within the Appointment are Progressing According to the Time Allotted

Do not wait until the last minute to ensure tasks are being completed. If tasks are not being completed as planned, whether too slow or too fast, the plan may need to be adjusted and feedback should be given. Careful monitoring of team members and the overall situation will ensure the team leader is leading successfully during the leadership appointment and the major duty or task will be accomplished.

Providing Feedback to the Team Members Throughout the Appointment

The team leader will provide feedback throughout the appointment. This feedback may be given to the team as a whole or it may be given to individual team members. Feedback should be provided such that it is frequent, accurate, specific, and timely. Successful supervision allows for ongoing feedback to be provided to the team. Feedback is necessary for the team members as it will allow them to develop as leaders also.

Modifying the Plan as Required

If the plan is not working, take time to modify it. If help is required from team members, ask for it. Modifying aspects of the plan partway through the appointment may benefit the outcome; however, always keep time limits and constraints in mind. If the plan is being revised, communicate the new plan to the team members and work with them to implement it.

PROVIDING FEEDBACK TO THE TEAM MEMBERS UPON CONCLUSION OF THE LEADERSHIP APPOINTMENT

It is important to give feedback to the team members upon conclusion of the leadership appointment. It is vital for the team leader to spend time focusing on how the team members worked together to achieve a common goal. When team members successfully complete a task, praise should be given. It is important to recognize dedication shown in seeing a task through to completion. Team leaders should try to recognize each team member for their contribution to the completion of a task.



It is important to know how the team members felt about their participation in the completion of the assignment.

The team leader should ask for feedback on the appointment from the team members. This can be done using general questions about the leadership appointment, such as:

- What was learned during the appointment?
- Was the goal met? What contributed to the success?
- How did everyone interact during the appointment?
- Were there behaviours that helped and / or hindered during the appointment?
- Were there any cadets who were not motivated to participate in the activity? How did this affect the morale of the remainder of the team?
- Were there leaders that emerged from within the team?

MEETING WITH THE ACTIVITY MANAGER TO DISCUSS THE OUTCOMES OF THE LEADERSHIP APPOINTMENT

Just as the team leader will provide ongoing feedback to the team members during the leadership appointment, the team leader will need periodic feedback from the activity manager to discuss and monitor progress of the major duty or task. Feedback from the activity manager should assist the team leader in improving performance. Once the leadership appointment is concluded, the team leader should meet with the activity leader for an overall debriefing. This feedback will aid the team leader during future leadership appointments.

CONFIRMATION OF TEACHING POINT 3

QUESTIONS:

- Q1. List the steps to conduct a leadership appointment.
- Q2. How does the team leader brief team members during a leadership appointment?
- Q3. After the leadership appointment is completed, why should the team leader meet with the activity manager to discuss the appointment?

ANTICIPATED ANSWERS:

- A1. The steps to conduct a leadership appointment are:
 - 1. prepare for the leadership appointment;
 - 2. brief the team members at the onset and then throughout the leadership appointment;
 - 3. carry out the tasks associated with the leadership appointment;
 - 4. provide feedback to the team members throughout and at the completion of the leadership appointment; and
 - 5. meet with the activity manager throughout and at the completion of the leadership appointment to discuss the outcomes of the leadership appointment.
- A2. The team leader briefs team members during a leadership appointment by:
 - 1. communicating the overall plan;
 - 2. communicating the tasks involved in the leadership appointment;
 - 3. assigning tasks to team members as applicable; and
 - 4. ensuring the team members understand their tasks.
- A3. After the leadership appointment is completed, the team leader should meet with the activity manager to discuss the appointment because feedback from the activity manager should give the team leader ideas to help improve performance.



Distribute the Leadership Appointment Aide-Memoire located at Attachment B to each cadet.

END OF LESSON CONFIRMATION

QUESTIONS:

- Q1. What kind of team will the team leader have during a leadership appointment?
- Q2. What leadership appointments are available at the squadron?
- Q3. List the steps to conduct a leadership appointment.

ANTICIPATED ANSWERS:

- A1. The team leader for a leadership appointment will have an assigned, established team of cadets outside their peer group.
- A2. Answers will vary.
- A3. The steps to conduct a leadership appointment are:
1. prepare for the leadership appointment;
 2. brief the team members at the onset and then throughout the leadership appointment;
 3. carry out the tasks associated with the leadership appointment;
 4. provide feedback to the team members throughout and at the completion of the leadership appointment; and
 5. meet with the activity manager throughout and at the completion of the leadership appointment to discuss the outcomes of the leadership appointment.

CONCLUSION

HOMEWORK / READING / PRACTICE

Nil.

METHOD OF EVALUATION

This EO is assessed IAW A-CR-CCP-804/PG-001, *Proficiency Level Four Qualification Standard and Plan* Chapter 3, Annex B, 403 PC.

CLOSING STATEMENT

When appointed as team leader for a given major duty or task, the team leader is expected to follow a series of steps for successful conclusion of the appointment. Being able to motivate cadets, solve problems, supervise followers, give feedback and develop the skills and knowledge of team members during a leadership appointment is an expectation of all year four cadets.

INSTRUCTOR NOTES / REMARKS

Acquire the list of leadership appointments developed by the Training Officer before instructing this lesson.

REFERENCES

C0-114 ISBN 0-02-863656-2 Pell, A. R. (1999). *The complete idiot's guide to team building*. Indianapolis, IN: Alpha Books.

C0-243 Clark, D. (2007). *After action reviews*. Retrieved February 21, 2008, from <http://www.nwlink.com/~donclark/leader/leadaar.html>

C0-243 Clark, D. (2007). *Leadership & direction*. Retrieved February 21, 2008, from <http://www.nwlink.com/~donclark/leader/leaddir.html>

C0-245 ISBN 1-58062-513-4 Adams, B. (2001). *The everything leadership book*. Avon, MA: Adams Media.

C0-247 ISBN 0-14-024272-4 Rosen, R. H., & Brown, P. B. (1997). *Leading people*. New York, NY: Penguin Books.

C0-248 ISBN 0-7894-4862-9 Heller, R. (1999). *Learning to lead*. New York, NY: DK Publishing, Inc.

C0-253 ISBN 0-7894-8006-9 Bruce, A., & Langdon, K. (2001). *Do it now!* New York, NY: DK Publishing, Inc.

C0-254 ISBN 0-7894-3244-7 Heller, R. (1998). *Communicate clearly*. New York, NY: DK Publishing, Inc.

C0-255 ISBN 0-7645-5408-5 Brounstein, M. (2002). *Managing teams for dummies*. Indianapolis, IN: Wiley Publishing, Inc.

C0-256 ISBN 0-7894-4863-7 Heller, R. (1999). *Achieving excellence*. New York, NY: DK Publishing, Inc.

THIS PAGE INTENTIONALLY LEFT BLANK

POSSIBLE YEAR FOUR LEADERSHIP ASSIGNMENTS

Recreational Marksmanship Assignments

- Set up a range for recreational marksmanship.
- Organize relays for recreational marksmanship.
- Control pellets and issue targets for recreational marksmanship.
- Conduct concurrent activities during recreational marksmanship.
- Tear down a range after recreational marksmanship.

Summer Biathlon Assignments

- Set up a range for a recreational summer biathlon activity.
- Conduct a warm-up activity prior to participating in a recreational summer biathlon activity.
- Control pellets for a recreational summer biathlon activity.
- Conduct a cool-down activity after participating in a recreational summer biathlon activity.
- Tear down a range after a recreational summer biathlon activity.

Recreational Sports Assignments

- Set up a recreational sports activity.
- Tear down a recreational sports activity.
- Organize a team for recreational sports.
- Conduct a warm-up prior to recreational sports.
- Conduct a concurrent activity during recreational sports.
- Conduct a cool-down after recreational sports.

Parade Assignments

- Set up chairs for a parade.
- Set up the dais area for a parade.
- Set up flags and parade markers for a parade.
- Tear down chairs after a parade.
- Tear down the dais area after a parade.
- Tear down flags and parade markers after a parade.

Weekly Cadet Night Assignments

- Set up classroom space.
- Rearrange classroom space.
- Tear down classroom space.

- Set up a canteen.
- Staff a canteen.
- Tear down a canteen.
- Set up a presentation area for a guest speaker.
- Tear down a presentation area for a guest speaker.
- Set up for an extracurricular activity.
- Conduct a concurrent activity.

Community Service Assignments

- Organize a team during a community service activity.
- Conduct concurrent activities during a community service activity.
- Complete a final garbage sweep.

Other Leadership Assignment Possibilities

- Ensure the safe loading and unloading of personnel on vehicles during transportation.
- Conduct uniform inspection of cadets.
- Collect and dispose of garbage after weekly parade.
- Collect, sort and dispose of recycling after weekly parade.
- Turn off lights and close windows after weekly parade.

AIR CADET SURVIVAL TRAINING ASSIGNMENTS

Prior to the Survival Training

- Distribute personal equipment.
- Label personal equipment.
- Load team equipment and supplies.

Setting Up the Bivouac Site

- Unload equipment and supplies.
- Construct a food hang.
- Set up the POL, first aid and fire points.
- Set up the female sleeping area.
- Set up the male sleeping area.
- Mark the components of the bivouac site.

Routine Tasks That Will Occur Throughout the Survival Training

- Prepare a meal for a section.
- Clean up the site after a meal.
- Prepare the bivouac site for the night.
- Organize lights out for the female cadets.
- Organize lights out for the male cadets.

Tearing Down the Bivouac Site

- Tear down the female sleeping area.
- Tear down the male sleeping area.
- Dismantle the POL, first aid and fire points.
- Load team equipment and supplies after the survival training.
- Erase signs of occupancy and complete a final garbage sweep.

After the Survival Training

- Unload equipment and supplies.
- Collect personal equipment.

AIR CADET GLIDING DAY ASSIGNMENTS

- Organize the distribution of a meal.
- Clean up the site after a meal.
- Conduct concurrent activities.
- Complete a final garbage sweep.

AIR CADET SKILLS DAY ASSIGNMENTS

- Organize the distribution of a meal.
- Clean up the site after a meal.
- Set up a skills activity.
- Organize a team for a skills activity.
- Conduct a warm-up prior to the skills activity.
- Conduct a concurrent activity during the skills activity.
- Conduct a cool-down after skills activity.
- Tear down a skills activity.
- Complete a final garbage sweep.

POSSIBLE YEAR FOUR LEADERSHIP APPOINTMENTS

Organizational Appointments

- Flight Sergeant,
- Flight Commander,
- Squadron Commander,
- Drum Major, and
- Flag Party Commander.

Training Appointments

- Proficiency Level Instructor,
- Aviation Subjects Instructor,
- Leadership and Ceremonial Instructor,
- Fitness and Sports and Instructor,
- Air Rifle Marksmanship Instructor,
- Survival Instructor, and
- Band Section Leader.

Supplementary Appointments

- Supply Assistant,
- Administration Assistant,
- Training Assistant,
- Canteen Steward,
- Drill Team Commander,
- Marksmanship Team Captain,
- Range Assistant,
- First Aid Team Captain,
- Biathlon Team Captain, and
- Sports Team Captain.

LEADERSHIP APPOINTMENT AIDE-MEMOIRE

TABLE OF CONTENTS

Leadership Assignment	B-2
Leadership Appointment	B-2
How to Conduct a Leadership Appointment	B-2
Preparing for the Leadership Appointment	B-2
Briefing Team Members During a Leadership Appointment	B-3
Carrying Out the Tasks Associated With the Leadership Appointment	B-3
Providing Feedback to the Team Upon Conclusion of the Leadership Appointment	B-4
Meeting With the Activity Manager to Discuss the Outcomes of the Leadership Appointment	B-4
403 PC 01 Assessment Rubric Leadership Assignment	B-5
403 PC 02 Assessment Rubric Leadership Appointment	B-6

During year four training, each cadet will be assessed at least once on a leadership assignment and once on a leadership appointment.

LEADERSHIP ASSIGNMENT

A leadership assignment is a specific, short- or long-term practical leadership opportunity during which the team leader must apply their leadership skills. The team leader will have temporary team members either within or outside their peer group for whom they will be responsible. The team will accomplish a singular minor duty or task.

LEADERSHIP APPOINTMENT

A leadership appointment is a specific long-term practical leadership opportunity that is more comprehensive in nature than a leadership assignment. The team leader must apply their leadership knowledge and skills and display the core leadership qualities of a cadet. The team leader will have an assigned, established team of cadets outside their peer group. The team will accomplish a singular major duty or task. These may be organizational appointments (eg, Flight Sergeant, Squadron Commander, etc.), training appointments (eg, Proficiency Level Instructor, Leadership and Ceremonial Instructor, etc.) or supplementary appointments (eg, Canteen Steward, Drill Team Commander, etc.). In generating leadership appointments, consideration must be given to the duration of the major duty or task and frequency of opportunities to exercise leadership. The team leader is expected to meet with their team on a number of occasions over a period of time. Leadership appointments may be held by a single PL4 cadet (eg, Drill Team Commander) or the PL4 cadets may rotate through a position (eg, Canteen Steward). If a PL4 cadet rotates through a leadership appointment, the appointment must be meaningful for the cadet and be of a duration that allows the cadet to meet the objectives of applying their leadership knowledge and skills and displaying the core leadership qualities of a cadet.

The team leader must supervise team members, communicate with team members to solve problems, strive to meet the needs and expectations of team members, motivate team members, and provide feedback to team members. The team leader must attempt to develop the skills and knowledge of their team members.

Direction for the leadership appointment must be given by a superior, usually an activity leader or activity manager.

HOW TO CONDUCT A LEADERSHIP APPOINTMENT

When conducting the leadership appointment, use the following steps:

1. prepare for the leadership appointment;
2. brief the team members at the onset and then throughout the leadership appointment;
3. carry out the tasks associated with the leadership appointment;
4. provide feedback to the team members throughout and at the completion of the leadership appointment;
and
5. meet with the activity manager throughout and at the completion of the leadership appointment to discuss the outcomes of the leadership appointment.

PREPARING FOR THE LEADERSHIP APPOINTMENT

Ensuring the Required Resources are Available

Make sure all the resources necessary for using during the appointment are available. For example, if the appointment is to act as a flag party commander, the flags, poles, etc will need to be available, both for practice and performance opportunities.

Completing a Time Appreciation

Be aware of the end date of the appointment. If the appointment is comprised of stages or phases, the leader must determine how much time to allocate to each stage or phase. All members involved in the appointment must be aware of the current date and the end date of the appointment.

Making a Plan

Make a plan to be successful in the appointment by:

1. determining what stages or phases comprise the appointment;
2. determining tasks inherent within the appointment;
3. developing a process to accomplish all tasks; and
4. identifying and allocating resources.

BRIEFING TEAM MEMBERS DURING THE LEADERSHIP APPOINTMENT

Communicating the Overall Plan

Explain how the appointment will be carried out. All team members should know what is involved as the leader carries out the appointment. This may include identifying various stages and phases.

Communicating the Tasks Involved in the Leadership Appointment

Explain the tasks involved within the leadership appointment. Leadership appointments may be comprised of a series of tasks.

Assigning Tasks to Team Members as Applicable

Assign each team member the tasks that must be completed within the scope of the appointment. Every team member should be actively engaged in a meaningful activity.

Ensuring the Team Members Understand Their Tasks

Confirm the team members understand their tasks and ask the team members if they have any questions. The team leader should also ask a few questions to various team members to ensure comprehension. When team members are assigned specific tasks, it is important they understand what is expected of them.

CARRYING OUT THE TASKS ASSOCIATED WITH THE LEADERSHIP APPOINTMENT

Supervising Team Members

Throughout the leadership appointment, the team leader will have many occasions during which to supervise team members. The most important aspect of supervision is to ensure the tasks are being conducted safely. Supervision also allows the team leader to provide ongoing feedback to team members.

Ensuring the Tasks Within the Appointment are Progressing According to the Time Allotted

Do not wait until the last minute to ensure tasks are being completed. If tasks are not being completed as planned, whether too slow or too fast, the plan may need to be adjusted and feedback should be given. Careful monitoring of team members and the overall situation will ensure the team leader is leading successfully during the leadership appointment and the major duty or task will be accomplished.

Providing Feedback to the Team Members Throughout the Appointment

The team leader will provide feedback throughout the appointment. This feedback may be given to the team as a whole or it may be given to individual team members. Feedback should be provided such that it is frequent, accurate, specific, and timely. Successful supervision allows for ongoing feedback to be provided to the team. Feedback is necessary for the team members as it will allow them to develop as leaders also.

Modifying the Plan as Required

If the plan is not working, take time to modify it. If help is required from team members, ask for it. Modifying aspects of the plan partway through the appointment may benefit the outcome; however, always keep time limits and constraints in mind. If the plan is being revised, communicate the new plan to the team members and work with them to implement it.

PROVIDING FEEDBACK TO THE TEAM MEMBERS UPON CONCLUSION OF THE LEADERSHIP APPOINTMENT

It is important to give feedback to the team members upon conclusion of the leadership appointment. It is vital for the team leader to spend time focusing on how the team members worked together to achieve a common goal. When team members successfully complete a task, praise should be given. It is important to recognize dedication shown in seeing a task through to completion. Team leaders should try to recognize each team member for their contribution to the completion of a task.

The team leader should ask for feedback on the appointment from the team members. This can be done using general questions about the leadership appointment, such as:

- What was learned during the appointment?
- Was the goal met? What contributed to the success?
- How did everyone interact during the appointment?
- Were there behaviours that helped and / or hindered during the appointment?
- Were there any cadets who were not motivated to participate in the activity? How did this affect the morale of the remainder of the team?
- Were there leaders that emerged from within the team?

MEETING WITH THE ACTIVITY MANAGER TO DISCUSS THE OUTCOMES OF THE LEADERSHIP APPOINTMENT

Just as the team leader will provide ongoing feedback to the team members during the leadership appointment, the team leader will need periodic feedback from the activity manager to discuss and monitor progress of the major duty or task. Feedback from the activity manager should assist the team leader in improving performance. Once the leadership appointment is concluded, the team leader should meet with the activity leader for an overall debriefing. This feedback will aid the team leader during future leadership appointments.

**403 PC 01 ASSESSMENT RUBRIC
LEADERSHIP ASSIGNMENT**

	Incomplete (I)	Completed With Difficulty (D)	Completed Without Difficulty (C)	Exceeded the Standard (E)
Select a leadership approach.	Did not select an approach appropriate to the assignment.	Selected an approach and was challenged with balancing focus on the team members and the goal.	Selected an approach and strived to balance team members and the goal and simplicity and safety of the task.	Selected the most appropriate approach with a strong balance of team members and the goal and simplicity and safety of the task.
Communicate as a team leader.	Did not communicate with team members.	Communicated with team members occasionally. Team members needed clarification on many occasions.	Communicated with team members on many occasions. Team members needed few clarifications.	Communicated to the team throughout the leadership task. Team members did not need clarification.
Supervise team members.	Did not supervise team members.	Only supervised team members at the beginning and / or end of the leadership assignment.	Supervised throughout the leadership assignment making some corrections when necessary.	Supervised throughout the leadership assignment making corrections as necessary.
Solve problems.	Did not solve problems.	Attempted to solve some problems and selected inefficient problem solving methods.	Solved most problems as they arose and often selected the appropriate problem solving method.	Solved problems as they arose and selected the most appropriate problem solving method.
Motivate team members.	Did not motivate team members.	Only motivated periodically and without enthusiasm.	Motivated frequently and with enthusiasm, with attention at times to both individuals and the team.	Motivated consistently and with enthusiasm, addressing both individuals and the team.
Provide feedback to team members.	Did not provide feedback to team members.	Provided select feedback; was not always frequent, accurate, specific and / or timely.	Provided periodic feedback and was often frequent, accurate, specific and / or timely.	Provided consistent feedback and was regularly frequent, accurate, specific and / or timely.
Meet expectations of team members.	Made no effort to meet the needs and expectations of team members.	Made some efforts to meet the needs and expectations of team members but with limited results.	Made considerable efforts to meet the needs and expectations of team members with adequate results.	Made consistent efforts to meet the needs and expectations of team members with solid results.
Complete the leadership assignment.	Did not complete the leadership assignment.		Completed the leadership assignment.	
Perform self-assessment.	Did not complete the self-assessment.		Completed the self-assessment.	

**403 PC 02 ASSESSMENT RUBRIC
 LEADERSHIP APPOINTMENT**

	Incomplete (I)	Completed With Difficulty (D)	Completed Without Difficulty (C)	Exceeded the Standard (E)
Select a leadership approach.	Did not select appropriate approach(es) throughout the appointment.	Selected an approach and was challenged with balancing focus on the team members and the goal throughout the appointment.	Selected approach(es) throughout the appointment and strived to balance team members and the goal and simplicity and safety of the task.	Selected the most appropriate approach(es) throughout the appointment with a strong balance of team members and the goal and simplicity and safety of the task.
Communicate as a team leader.	Did not communicate with team members.	Did not communicate with team members frequently enough. Team members needed clarification on many occasions.	Communicated with team members on many occasions. Team members needed few clarifications.	Communicated with team members consistently throughout the leadership appointment. Team members did not need clarification.
Supervise team members.	Did not supervise team members.	Did not successfully apply the principles of supervision; supervision was infrequent throughout the appointment.	Supervised throughout the leadership appointment, making some corrections when necessary.	Supervised consistently throughout the leadership assignment, making corrections as necessary.
Solve problems.	Did not solve problems.	Attempted to solve some problems and selected inefficient problem solving methods.	Solved most problems as they arose and often selected the appropriate problem solving method.	Solved problems as they arose and selected the most appropriate problem solving method.
Motivate team members.	Did not motivate team members.	Only motivated periodically and without enthusiasm.	Motivated frequently and with enthusiasm, with attention at times to both individuals and the team.	Motivated consistently and with enthusiasm, addressing both individuals and the team.
Provide feedback to team members.	Did not provide feedback to team members.	Provided select feedback; was not always frequent, accurate, specific and / or timely.	Provided periodic feedback and was often frequent, accurate, specific and / or timely.	Provided consistent feedback and was regularly frequent, accurate, specific and / or timely.
Meet expectations of team members.	Made no effort to meet the needs and expectations of team members.	Made some efforts throughout the appointment to meet the needs and expectations of team members but with limited results.	Made considerable efforts throughout the appointment to meet the needs and expectations of team members with adequate results.	Made consistent efforts throughout the appointment to meet the needs and expectations of team members with solid results.
Perform self-assessment.	Did not complete the self-assessment.		Completed the self-assessment.	



**COMMON TRAINING
PROFICIENCY LEVEL FOUR
INSTRUCTIONAL GUIDE**



SECTION 7

EO C403.01 – PARTICIPATE IN A LEADERSHIP SEMINAR

Total Time:

90 min

PREPARATION

PRE-LESSON INSTRUCTIONS

Resources needed for the delivery of this lesson are listed in the lesson specification located in A-CR-CCP-804/PG-001, *Proficiency Level Four Qualification Standard and Plan*, Chapter 4. Specific uses for said resources are identified throughout the instructional guide within the TP for which they are required.

Review the lesson content and become familiar with the material prior to delivering the lesson.

Review the information on seminars located at Attachment A.

Choose one of the four seminars. Prepare all materials for the seminar located at Attachments B–E.

PRE-LESSON ASSIGNMENT

Nil.

APPROACH

A seminar method was chosen for this lesson to stimulate active participation in a tutorial setting and to allow cadets to practice reflective thinking skills. Seminars assist cadets in developing new and imaginative interpretations of leadership topics being explored. Seminars are an interactive way to exchange information on techniques and approaches to the leadership subjects being researched and discussed.

INTRODUCTION

REVIEW

Nil.

OBJECTIVES

By the end of this lesson the cadets shall have participated in a leadership seminar.

IMPORTANCE

It is important for cadets to participate in a leadership seminar so they have an opportunity to further develop their leadership skills and knowledge. Leadership seminars allow cadets to discuss the best practices and explore leadership topics. This EO may be an introduction to the seminar format, which will be used throughout Proficiency Level Five.

Teaching Point 1

Have the cadets participate in a leadership seminar.

Time: 80 min

Method: Seminar



Have the cadets participate in a leadership seminar on one or more of the following topics:

- problem solving,
- time management,
- communication, and
- supervision.

ACTIVITY

OBJECTIVE

The objective of this activity is to have the cadets participate in a leadership seminar.

RESOURCES

As per the selected topic (located at Attachments B–E).

ACTIVITY LAYOUT

Set up the classroom IAW the selected leadership seminar (located at Attachments B–E).

ACTIVITY INSTRUCTIONS

Follow the activity instructions IAW the selected leadership seminar (located at Attachments B–E).

SAFETY

Nil.

CONFIRMATION OF TEACHING POINT 1

The cadets' participation in a leadership seminar will serve as the confirmation of this TP.

END OF LESSON CONFIRMATION

The cadets' participation in a leadership seminar will serve as the confirmation of this lesson.

CONCLUSION

HOMEWORK / READING / PRACTICE

Nil.

METHOD OF EVALUATION

Nil.

CLOSING STATEMENT

Participating in leadership seminars may assist you in further developing leadership skills and knowledge. One can never know all there is to know about leadership and seminars are an important tool to further explore each leadership topic. In addition, the seminar format used during this lesson will be used throughout Proficiency Level Five.

INSTRUCTOR NOTES / REMARKS

This EO may be conducted as many as four times during Proficiency Level Four training.

REFERENCES

C0-022 ISBN 0-02864-207-4 Cole, Kris (2002). *The complete idiot's guide to clear communication*. Indianapolis, IN: Alpha Books.

C0-115 ISBN 0-7879-4059-3 van Linden, J. A., & Fertman, C. I. (1998). *Youth leadership*. San Francisco, CA: Jossey-Bass Inc., Publishers.

C0-425 Shurdington Scouts Resource. (1999). *NASA exercise: Survival on the moon*. Retrieved April 14, 2009, from <http://www.shurdington.org/Downloads/NASA%20Exercise.pdf>

C0-477 Mindtools: Essential skills for an excellent career. (2009). *Stepladder technique: Making better group decisions*. Retrieved April 14, 2009, from http://www.mindtools.com/pages/article/newTED_89.htm

C0-477 Mindtools: Essential skills for an excellent career. (2009). *Six thinking hats*. Retrieved April 14, 2009, from http://www.mindtools.com/pages/article/newTED_07.htm

C0-477 Mindtools: Essential skills for an excellent career. (2009). *Why do we procrastinate*. Retrieved March 30, 2009, from http://www.mindtools.com/pages/article/newHTE_96.htm

C0-477 Mindtools: Essential skills for an excellent career. (2009). *Preparing a to-do list*. Retrieved March 30, 2009, from http://www.mindtools.com/pages/article/newHTE_05.htm

C0-477 Mindtools: Essential skills for an excellent career. (2009). *Simple prioritization*. Retrieved March 30, 2009, from http://www.mindtools.com/pages/article/newHTE_92.htm

C0-479 PedagoNet: Brainteasers. (2009). *Problem solving: Do you have the answer?* Retrieved April 15, 2009, from <http://www.pedagonet.com/brain/brainers.html>

C0-480 Discovery Education. (2009). *Brain boosters*. Retrieved April 15, 2009, from <http://school.discoveryeducation.com/brainboosters/>

C0-481 Total success: A different type of training. (2009). *Time management: Manage yourself, not your time*. Retrieved March 31, 2009, from <http://www.tsuccess.dircon.co.uk/timemanagementtips.htm>

C0-482 About.com: Small Business: Canada. (2009). *11 Time management tips*. Retrieved March 30, 2009, from <http://sbinfocanada.about.com/cs/timemanagement/a/timemgttips.htm>

C0-483 College Board: Inspiring Minds (2009). *Time management tips for high school students*. Retrieved March 31, 2009, from <http://www.collegeboard.com/student/plan,college-success/116.html>

C0-487 Department for Community Development, Government of Western Australia. (2008). *Supervision of children*. Retrieved April 1, 2009, from <http://www.pscwa.org.au/documents/DCDGUIOSHCFactSheetSupervisionofChildren.pdf>

THIS PAGE INTENTIONALLY LEFT BLANK

SEMINAR INFORMATION

SEMINARS

Seminars are effective ways to communicate information on a particular topic to the rest of the group. Seminars are a tutorial arrangement involving an instructor and a small group. They are best used as a part of the developmental learning process. A seminar will be meaningful and realistic when it is focused on specific needs.

Seminars have many uses. They can be used to:

- pass on new information to a group;
- provide general guidance for a group working on a project;
- exchange information on techniques and approaches being explored by members of a group; and
- develop new and imaginative solutions to problems a group is encountering.

PREPARATION OF A GROUP

Prepare the group attending the activity so that they understand the importance of the seminar and are in the proper mindset. The instructor should:

1. prepare the problem, project, or topic of study in advance of the session;
2. introduce the lesson, identify the topic and its importance / relevance to the group, and describe how the seminar will proceed prior to the actual forum; and
3. assign research or study materials on a topic, prior to the seminar, if appropriate.

HOW TO CONDUCT A SEMINAR

During a seminar, employ strategies / approaches to explore new material, solve problems and exchange information such as:

- instructor presentation;
- learner presentation;
- group discussion;
- group brainstorming; or
- group work.

Follow the discussions and lead the group to draw conclusions regarding how to solve the problem or how they will use the new information.

Finally, close the discussion by highlighting the major conclusions and decisions made.

Workshops are similar and closely related to seminars. During a workshop, the group is presented with a problem or study subject and are required to produce possible solutions. A workshop can be used as an aspect of a seminar where the group concentrates on small amounts of material.

THIS PAGE INTENTIONALLY LEFT BLANK

LEADERSHIP SEMINAR PROBLEM SOLVING

Total Time:

90 min

PREPARATION

Photocopy Appendices 1, 4, 5 and 6 to Attachment B for each cadet.

Photocopy Appendices 2 and 3 to Attachment B.

The following components are conducted during this seminar:

Number	Component	Time
1	Conduct an in-class activity where cadets solve the NASA moon survival scenario individually.	10 min
2	Conduct an in-class activity where cadets solve the NASA moon survival scenario as a group.	20 min
3	Conduct a group discussion on the NASA moon survival scenario.	10 min
4	Explain how to use the stepladder problem-solving technique and the six thinking hats technique.	10 min
5	Conduct an in-class activity where cadets solve a problem using the stepladder or six thinking hats technique.	10 min
6	Have cadets solve problems.	15 min
7	Conduct a group discussion on the problem-solving seminar.	5 min

CONDUCT AN IN-CLASS ACTIVITY WHERE CADETS SOLVE THE NASA MOON SURVIVAL SCENARIO INDIVIDUALLY

ACTIVITY

Time: 10 min

OBJECTIVE

The objective of this activity is to have the cadets solve the NASA Survival on the Moon scenario individually.

RESOURCES

- NASA Survival on the Moon scenario and individual answer sheet located at Appendix 1 to Attachment B, and
- Pen / pencil.

ACTIVITY LAYOUT

Nil.

ACTIVITY INSTRUCTIONS

1. Distribute the NASA Survival on the Moon scenario and individual answer sheet to each cadet.
2. Have the cadets complete the NASA Survival on the Moon scenario.

SAFETY

Nil.

CONDUCT AN IN-CLASS ACTIVITY WHERE CADETS SOLVE THE NASA MOON SURVIVAL SCENARIO AS A GROUP

ACTIVITY

Time: 20 min

OBJECTIVE

The objective of this activity is to have cadets solve the NASA Survival on the Moon scenario as a group.

RESOURCES

- NASA Survival on the Moon scenario,
- Completed NASA Survival on the Moon scenario and individual answer sheet from previous activity,
- NASA Survival on the Moon team answer sheet located at Appendix 2 to Attachment B, and
- Pen / pencil.

ACTIVITY LAYOUT

Nil.

ACTIVITY INSTRUCTIONS

1. Distribute NASA Survival on the Moon scenario to one cadet from the group.
2. Have one cadet read the scenario to the group.
3. Have the cadets complete the NASA Survival on the Moon scenario as a group using their previous answers as a guide.
4. Review the group's answers to the NASA Survival on the Moon scenario using Appendix 3 to Attachment B.
5. Have cadets score their answers as a group and then as individuals.

SAFETY

Nil.

CONDUCT A GROUP DISCUSSION ON THE NASA MOON SURVIVAL SCENARIO

Time: 10 min

BACKGROUND KNOWLEDGE



The purpose of the group discussion is to draw the following information from the group using the tips for answering / facilitating discussion and the suggested questions provided.

TRANSACTIONAL AND TRANSFORMATIONAL LEADERSHIP

Transactional leadership. Leaders exchange promises of rewards and benefits to team members so the team members will fulfill agreements with the leaders. This type of leadership is task-oriented. The leader sets the rules and procedures to complete a task and the team members comply with the rules and follow the procedures to accomplish the task.

Transactional Leadership:

- Values problem and solution identification.
- Makes decisions – even if everyone has not been heard – in order to move forward.
- Uses standards and principles as guides in decision making.
- Develops the self to be a better decision maker for the group.
- Gets things done.
- Recognizes the importance of the product.
- Takes charge (personal power).

Transformational leadership. Focuses on the process of being a leader by helping team members transform themselves from followers into leaders. Transformational leadership involves assisting team members to transcend their own self-interest for the good of the group, organization or society; to consider their long-term needs to develop themselves, rather than their immediate needs; and generally, to become more aware of what is really important.

Transformational Leadership:

- Values the participation and contribution of others.
- Takes all viewpoints and advice into account before making a decision.
- Considers individuals within their contexts and situations.
- Uses individuals to test decisions.
- Develops the self first to be a better contributor to the group.
- Learns from experiences to generalize to 'real life'.

- Recognizes the importance of the process.
- Shares leadership (group power).



Leadership within the cadet program has been designed to create transformational leadership. Transformational leadership enables the Cadet Program to meet its first aim—to develop in youth the attributes of good citizenship and leadership.

Transactional leadership focuses on the skills and tasks associated with leadership, such as public speaking, writing, delegating authority, leading meetings and making decisions. It is what people who are leaders do. Transformational leadership focuses on the process of leadership and what it means to be a leader. It is concerned with how individuals use their abilities to influence people. Think of the main difference between transactional and transformational leadership as doing leadership tasks versus being a leader.

GROUP DISCUSSION



TIPS FOR ANSWERING / FACILITATING DISCUSSION:

- Establish ground rules for discussion, eg, everyone should listen respectfully; don't interrupt; only one person speaks at a time; no one's ideas should be made fun of; you can disagree with ideas but not with the person; try to understand others as much as you hope they understand you; etc.
- Sit the group in a circle, making sure all cadets can be seen by everyone else.
- Ask questions that will provoke thought; in other words avoid questions with yes or no answers.
- Manage time by ensuring the cadets stay on topic.
- Listen and respond in a way that indicates you have heard and understood the cadet. This can be done by paraphrasing their ideas.
- Give the cadets time to respond to your questions.
- Ensure every cadet has an opportunity to participate. One option is to go around the group and have each cadet answer the question with a short answer. Cadets must also have the option to pass if they wish.
- Additional questions should be prepared ahead of time.

SUGGESTED QUESTIONS:

- Q1. Based on the two previous activities, which decisions were easier to make—individually or as a group?
- Q2. Which do you think was more effective?
- Q3. Give some examples of how decisions were made.
- Q4. Who influenced the decisions and how?
- Q5. Could better decisions have been made? How?
- Q6. How was conflict managed?

- Q7. How do you feel about the decisions?
- Q8. Were you satisfied with each decision? Why or why not?
- Q9. What would you change if you did this again?



Other questions and answers will develop throughout the group discussion. The group discussion should not be limited to only those suggested.



Reinforce those answers given and comments made during the group discussion, ensuring the teaching point has been covered.

EXPLAIN HOW TO USE THE STEPLADDER PROBLEM SOLVING TECHNIQUE AND THE SIX THINKING HATS TECHNIQUE

Time: 10 min

The Stepladder Technique

The stepladder technique is a step-by-step approach to help ensure that all members of the group are heard. The technique allows shy, quiet people to present their ideas to the group before other group members may influence them. This method allows everyone to hear many different viewpoints before reaching a final decision.

The stepladder technique steps:

1. present the problem or task;
2. form the core group of two members;
3. share ideas and discuss;
4. add the third member to the group;
5. share ideas and discuss;
6. add the fourth member to the group;
7. share ideas and discuss;
8. add additional members, one at a time, sharing ideas and discussing after each, until all members have been added; and
9. reach a final decision.

Many groups begin to lose effectiveness and the ability to make quality decisions if they have too many members. Keep the group small—four to six team members—to maximize effectiveness.

The Six Thinking Hats Technique

Six Thinking Hats is a good technique for looking at the effects of a decision from a number of different points of view. It allows necessary emotion and scepticism to be brought into what would otherwise be purely rational decisions. It opens up the opportunity for creativity within decision making. The Six Thinking Hats technique helps groups make better decisions by moving people outside their habitual ways of thinking. For example, persistently pessimistic cadets may be asked to be positive and creative.

Each Thinking Hat is a different style of thinking. These are:

White Hat. With this thinking hat, cadets must focus on the data available. They must look at the information they have and see what can be learned from it. They must look at gaps in the knowledge and either try to fill them or account for them. These cadets will analyze past trends and try to predict on the basis of what is known, what may happen.

Red Hat. With this thinking hat, cadets must look at the decision using intuition, gut reaction and emotion. They must try to think how other people may react emotionally, and try to understand the responses of others who do not know how the decision was made.

Black Hat. With this thinking hat, cadets must look at things pessimistically, cautiously and defensively. They try to see why ideas and approaches might not work. This may highlight the weak points in a plan or course of action. This allows the group to alter the approach or prepare contingency plans to counter problems that arise.

Yellow Hat. With this thinking hat, cadets must think only positively. They must keep an optimistic viewpoint that helps to see all the benefits and opportunities that arise from the decision or course of action. Yellow hat thinking helps to keep the group going when everything seems to be gloomy or difficult.

Green Hat. With this thinking hat, cadets must think creatively. They try to develop new, innovative and imaginative solutions to the problem or task. These cadets must think outside the box and not critique their own ideas before expressing them.

Blue Hat. With this thinking hat, cadets must focus on process control. This is the hat worn by people chairing the problem-solving session. When running into difficulties because ideas are running dry, they may direct cadets into a different coloured hat.

Using the Six Thinking Hats technique should improve the quality of decision-making. By "wearing" each of the thinking hats in turn, decisions are systematically explored.

CONDUCT AN IN-CLASS ACTIVITY WHERE CADETS SOLVE A PROBLEM SCENARIO USING THE STEPLADDER OR SIX THINKING HATS TECHNIQUE

ACTIVITY

Time: 10 min

OBJECTIVE

The objective of this activity is to have cadets solve a problem using the stepladder or Six Thinking Hats technique.

RESOURCES

Scenario located at Appendix 4 to Attachment B.

ACTIVITY LAYOUT

Nil.

ACTIVITY INSTRUCTIONS

1. Have the cadets select the stepladder technique or six thinking hats technique to solve the scenario.
2. Distribute the scenario to each cadet.
3. Have the cadets read the scenario.
4. Divide the cadets into groups of no more than six.
5. Have the cadets solve the scenario using the technique selected.

SAFETY

Nil.

HAVE CADETS SOLVE PROBLEMS

ACTIVITY

Time: 15 min

OBJECTIVE

The objective of this activity is to have the cadets solve problems.

RESOURCES

- Brainteasers and puzzles located at Appendix 5 to Attachment B, and
- Answer keys located at Appendix 6 to Attachment B.

ACTIVITY LAYOUT

Nil.

ACTIVITY INSTRUCTIONS



There are 10 problems to be solved. Cadets do not have to solve all the problems. Cadets should work on the problems in small groups.

1. Distribute Appendix 5 to Attachment B to each cadet.
2. Divide cadets into groups of no larger than three.
3. Have cadets solve the problems.
4. After 12 minutes, distribute answer keys located at Appendix 6 to Attachment B to each group.
5. Have the groups check their answers.

SAFETY

Nil.

CONDUCT A GROUP DISCUSSION ON THE PROBLEM-SOLVING SEMINAR

Time: 5 min



The purpose of the group discussion is to have cadets practice reflective thinking skills. Use the tips for answering / facilitating discussion and the suggested questions provided.

GROUP DISCUSSION



TIPS FOR ANSWERING / FACILITATING DISCUSSION:

- Establish ground rules for discussion, eg, everyone should listen respectfully; don't interrupt; only one person speaks at a time; no one's ideas should be made fun of; you can disagree with ideas but not with the person; try to understand others as much as you hope they understand you; etc.
- Sit the group in a circle, making sure all cadets can be seen by everyone else.
- Ask questions that will provoke thought; in other words avoid questions with yes or no answers.
- Manage time by ensuring the cadets stay on topic.
- Listen and respond in a way that indicates you have heard and understood the cadet. This can be done by paraphrasing their ideas.
- Give the cadets time to respond to your questions.
- Ensure every cadet has an opportunity to participate. One option is to go around the group and have each cadet answer the question with a short answer. Cadets must also have the option to pass if they wish.
- Additional questions should be prepared ahead of time.

SUGGESTED QUESTIONS:

- Q1. What have you learned during this seminar?
- Q2. Which activities did you enjoy during the seminar? Why?
- Q3. Will this information be useful to you?
- Q4. Where do you think you will use the information from this seminar?
- Q5. Now that you know the Stepladder and Six Thinking Hats Techniques, how have you changed your approach to solving a problem? How will this impact your decision-making?



Other questions and answers will develop throughout the group discussion. The group discussion should not be limited to only those suggested.



Reinforce those answers given and comments made during the group discussion, ensuring the teaching point has been covered.

THIS PAGE INTENTIONALLY LEFT BLANK



NASA Survival on the Moon

Scenario:

You are a member of a space crew originally scheduled to rendezvous with a mother ship on the lighted surface of the moon. However, due to mechanical difficulties, your ship was forced to land at a spot some 200 kilometres from the rendezvous point. During re-entry and landing, much of the equipment aboard was damaged and, since survival depends on reaching the mother ship, the most critical items available must be chosen for the 200-kilometre trip. The 15 items left intact and undamaged after landing are listed on the next page. Your task is to rank them in order of importance for your crew to help them reach the rendezvous point. Place the number 1 by the most important item, the number 2 by the second most important, and so on through number 15 for the least important.

NASA Survival on the Moon Individual Answer Sheet

Name _____

To be completed individually.

- _____ Box of Matches
- _____ Food Concentrate
- _____ 15 Metres of Nylon Rope
- _____ Parachute Silk
- _____ Portable Heating Unit
- _____ Two .45 Calibre Pistols
- _____ One Case of Dehydrated Milk
- _____ Two 50-Kilogram Tanks of Oxygen
- _____ Stellar Map
- _____ Self-Inflating Life Raft
- _____ Magnetic Compass
- _____ 20 Litres of Water
- _____ Signal Flares
- _____ First Aid Kit, Including Injection Needle
- _____ Solar-Powered FM Receiver-Transmitter

NASA Survival on the Moon Team Answer Sheet

TEAM NAME _____

To be completed as a group.

Team ranking

NASA Ranking

_____ Box of Matches _____

_____ Food Concentrate _____

_____ 15 Metres of Nylon Rope _____

_____ Parachute Silk _____

_____ Portable Heating Unit _____

_____ Two .45 Calibre Pistols _____

_____ One Case of Dehydrated Milk _____

_____ Two 50-Kilogram Tanks of Oxygen _____

_____ Stellar Map _____

_____ Self-inflating Life Raft _____

_____ Magnetic Compass _____

_____ 20 Litres of water _____

_____ Signal Flares _____

_____ First Aid Kit, Including Injection Needle _____

_____ Solar-Powered FM Receiver-Transmitter _____

THIS PAGE INTENTIONALLY LEFT BLANK

Answers to the Survival on the Moon

ITEM	NASA RANKING	NASA REASONING
Box of Matches	15	Virtually worthless—there is no oxygen on the moon to sustain combustion.
Food Concentrate	4	Efficient means of supplying energy requirements.
15 Metres of Nylon Rope	6	Useful for scaling cliffs and for tying team members together while scaling cliffs.
Parachute Silk	8	Protection from the sun's rays.
Portable Heating Unit	13	Not needed unless on the dark side of the moon.
Two .45 Calibre Pistols	11	Possible means of self-propulsion.
One Case of Dehydrated Milk	12	Bulkier duplication of food concentrate.
Two 50-Kilogram Tanks of Oxygen	1	Most pressing survival need (weight is not a factor since gravity is one-sixth of the Earth's).
Stellar Map	3	Primary means of navigation—star patterns appear essentially identical on the moon as on Earth.
Self-Inflating Life Raft	9	Carbon dioxide bottle in the military raft may be used for propulsion.
Magnetic Compass	14	The magnetic field on the moon is not polarized, so it is worthless for navigation.
20 Litres of Water	2	Needed for tremendous liquid loss on the light side of the moon.
Signal Flares	10	Use as distress signal when the mother ship is sighted.
First Aid Kit Including Injection Needle	7	Needles connected to vials of vitamins and medicines will fit in a special aperture in the NASA spacesuit.
Solar-Powered FM Receiver-Transmitter	5	For communications with the mother ship (FM radio requires line of sight transmission and can only be used over a short range).

Scoring:

For each item, mark the number of points that your team score differs from the NASA ranking, then add up all the points. Disregard plus or minus differences. The lower the total, the better your score.

0–25 excellent

26–32 good

33–45 average

46–55 fair

56–70 poor—suggests use of Earth-bound logic.

71–112 very poor—you are one of the casualties of the space program!

STEPLADDER OR SIX THINKING HATS SCENARIO

Your squadron has been given a large grant from the town / city of \$20 000. The squadron staff want to spend the money on a tour. The entire squadron can go on a fully paid tour of Washington, DC for seven days or the squadron can send two cadets from each proficiency level on a fully paid tour for one week to World War II sites in Europe. A decision must be made and the squadron staff would like your input.

THIS PAGE INTENTIONALLY LEFT BLANK

PROBLEMS TO SOLVE

Problem #1

Four women, Louise, Lise, Carol and Lily, are seated at a table. They are chatting about their holidays.

They went to California, Texas, Florida and Arizona riding a lion, a tiger, a zebra, and a pony.

Question: What are the destinations and mode of transportation for each woman?

Hints:

- The woman riding the zebra did not smoke.
- Carol declared that she loved Miami.
- The woman riding the tiger had a cigarette with Lily.
- Louise said "Buy your pony a new saddle, Carol. I saw some during our trip to California?"
- The women riding the tiger mentioned that she has seen the Alamo in Texas.
- Lise was a chain smoker.

Problem #2

An army general wanted 10 soldiers to cross a river. There was no bridge and the soldiers could not swim. The general saw a row boat with two children on board. The boat could only hold two children or one soldier.

Question: How did the soldiers cross the river in the boat?

Problem #3

A crime has been committed. A life has been taken. The name, address and personal information are known to the police. However, this person shall never go to trial.

Question: Why?

Problem #4

A knight wanted to visit a princess. He had to arrive exactly at 1700 hours. If he travelled at 15 kilometres per hour, he would arrive one hour too early. If he travelled at 10 kilometres per hour, he would arrive one hour too late.

Questions:

At what time should he leave?

What distance will he travel?

At what speed will he travel?

Problem #5

A large ship is ignited on the high seas. All sailors, except the captain, leave aboard lifeboats. The captain dives and swims under the water for 90 metres. He hears an explosion. When he surfaces, he immediately hears another explosion. The captain rejoins a lifeboat and is pulled aboard by the sailors.

The captain mentions that he heard two explosions. The sailors state that they only heard one explosion. Both the captain and the sailors are telling the truth.

Question: How is this possible?

Problem #6

A girl, who was just learning to drive, went down a one-way street in the wrong direction, but did not break the law.

Question: How is this possible?

Problem #7

After school on Monday, Jody found this note in code taped to her locker.

Yg ctg jcxkpi c uwtrtkug rctva hqt Ou. Dtqyp.

At first, she couldn't figure it out. Then someone whispered in her ear, "M stands for K." Just that one clue helped Jody crack the code.

Question: What does the note say? How did you crack the code?

Problem #8

One man, one woman and some kids are out boating. There were three boats—one red, one blue, and one yellow—out on the river that morning. The boats were three different types: a yacht, a sailboat and a canoe. The people on the boats were from three different countries: France, Sweden and Italy.

Questions: What colour is each boat? What type is each boat? Who is on each boat? Which country do the people come from?

Hints:

- The woman is not in a yellow boat and is not from France.
- The red boat is not from Italy.
- The kids are in a blue boat, but they are not from Italy or Sweden.
- The man and his dog are on a yacht with an Italian flag.
- The sailboat is from France, while the canoe is red.

Problem #9

Amir tied two sacks of salt to the back of his donkey and headed for the market to sell the salt. On the way, Amir and the donkey passed a stream. The donkey jumped in to cool himself. As a result, much of the salt dissolved into the water, ruining the salt for Amir but improving matters for the donkey because his load became much lighter. Amir tried to get to the market on the following days, but the donkey always ruined the salt. Finally, Amir decided to teach the donkey a lesson. He once again set out with the donkey and the two sacks.

Question: What did Amir do differently this time so that after that day the donkey stopped taking a swim?

Problem #10

Train A and train B are crossing the country, from coast to coast, over 5 000 kilometres of railroad track. Train A is going from east to west at 80 kilometres per hour, and Train B is going from west to east at 90 kilometres per hour.

Question: Which train will be closer to the west coast when they meet?

Hint: You don't have to do any math to get the answer.

THIS PAGE INTENTIONALLY LEFT BLANK

ANSWER KEY TO PROBLEMS

Problem #1

Answer:

Louise - California - zebra
Lise - Texas - tiger
Carol - Florida - pony
Lily- Arizona - lion

Problem #2

Answer:

Start with two children crossing. One child gets out of the boat, the other child returns in the boat. The second child gets out of the boat and the soldier crosses. The first soldier gets out of the boat, and the first child gets in the boat and returns. Repeat the process until all the soldiers, the general and the children have crossed the river.

Problem #3

Answer:

No person shall go to trial because the crime was a suicide.

Problem #4

Answer:

He should leave at 1200 hours. He will travel 60 kilometres. He will travel 12 kilometres per hour.

Problem #5

Answer:

It is true because sound travels more rapidly under water than on the surface.

Problem #6

Answer:

She was walking.

Problem #7

Answer:

The message reads, "We are having a surprise party for Ms. Brown." M stands for K tells you that the alphabet has shifted two letters.

STRATEGY: Write the alphabet in a row, with a second alphabet below it, starting with a below c. When you get to x in the second row, go to the a in the top row and write y below it and z below b.

Problem #8

Answer:

Yellow - yacht - man - Italy

Red - canoe - woman - Sweden

Blue - sailboat - kids - France

Problem #9

Answer:

Amir loaded the sacks not with salt but with sand. When the donkey jumped in the stream and got the sacks wet, they became much heavier.

Problem #10

When the trains meet, they will be at exactly the same point. Therefore, they will each be the same distance from the west coast.

LEADERSHIP SEMINAR TIME MANAGEMENT

Total Time:

90 min

PREPARATION

Photocopy Appendix 1 to Attachment C.

The following components are conducted during this seminar:

Number	Component	Time
1	Explain that time management is a myth.	5 min
2	Conduct an activity where cadets brainstorm a list of time stealers.	10 min
3	Conduct an activity where cadets reflect on and create a list of activities where they spend the most time and the least time.	10 min
4	Explain procrastination.	10 min
5	Conduct an activity where cadets brainstorm time-management tips.	10 min
6	Explain time-management tips for teens.	5 min
7	Explain preparing to-do lists.	5 min
8	Conduct a group discussion on how technology may aid in time management.	5 min
9	Conduct an in-class activity where cadets create a to-do list based on a scenario.	15 min
10	Conduct a group discussion on the time-management seminar.	5 min

EXPLAIN THAT TIME MANAGEMENT IS A MYTH

Time: 5 min

TIME MANAGEMENT IS A MYTH

There are only 24 hours in every day. Time never changes. Time management does not refer to managing time; it refers to managing ourselves. Organizing and managing workload and free time is what is meant by time management. It means what one does with the time one has.

CONDUCT AN ACTIVITY WHERE CADETS BRAINSTORM A LIST OF TIME STEALERS

BACKGROUND KNOWLEDGE

Time stealers include:

- interruptions (telephones, visitors, etc),
- procrastination and indecisions,
- dealing with minor tasks that should have be delegated,
- acting with incomplete information,
- lack of planning,

- stress and fatigue,
- inability to say "No", and
- personal disorganization.

ACTIVITY

Time: 10 min

OBJECTIVE

The objective of this activity is to have the cadets brainstorm a list of time stealers.

RESOURCES

- Two flip charts, and
- Two markers.

ACTIVITY LAYOUT

Nil.

ACTIVITY INSTRUCTIONS

1. Divide the cadets into two groups.
2. Give each group a flip chart and marker.
3. Have each group brainstorm and record on the flip chart a list of time stealers.
4. Have one member from each group share their list with the class.

SAFETY

Nil.

CONDUCT AN ACTIVITY WHERE CADETS REFLECT ON AND CREATE A LIST OF ACTIVITIES WHERE THEY SPEND THE MOST TIME AND THE LEAST TIME

Time: 10 min

OBJECTIVE

The objective of this activity is to have the cadets reflect on and create a list of activities where they spend the most time and the least time.

RESOURCES

- Paper, and
- Pen / pencil.

ACTIVITY LAYOUT

Nil.

ACTIVITY INSTRUCTIONS

1. Distribute paper and pen / pencil to each cadet.
2. Explain to the cadets that they are to reflect and create a list of activities where they spend the most time and the least time.



Do not force cadets to share their list if they do not wish.

3. After six minutes have the cadets present their list to the class.

SAFETY

Nil.

EXPLAIN PROCRASTINATION

Time: 10 min

WHY DO CADETS PROCRASTINATE?

Procrastination is putting things off that should be focused on right now. Usually, things are put off in favour of doing something that is more enjoyable or that is easier to accomplish. Procrastinators work as many hours in a day as other cadets but procrastinators invest their time in the wrong tasks.

Sometimes this is simply because cadets do not understand the difference between urgent tasks (time-sensitive) and important tasks (significant), and they jump straight into urgent tasks that are not actually important. They may think they are doing the right thing because they are reacting quickly or they may simply be driven by the person whose demands are the loudest.

Important. Of great effect or consequence; significant.

Urgent. Demanding or requiring immediate action or attention.

Causes of Procrastination

Another common cause of procrastination is that cadets feel overwhelmed by the task. Cadets may not know where to begin, or they may doubt they have the skills or resources to complete the task. Cadets may seek comfort in doing tasks that they know they are capable of completing.

Other Causes of Procrastination

Other causes of procrastination include:

- waiting for the "right" mood or the "right" time to tackle the important tasks;
- a fear of failure or success;
- underdeveloped decision-making skills;

- poor organizational skills; and
- perfectionism (cadets think they do not have the right skills or resources to accomplish the task perfectly so they do not begin at all).



Ask cadets to name some tasks that they might procrastinate on rather than getting started.

HOW TO OVERCOME PROCRASTINATION

Whatever the reason behind procrastination, it must be acknowledged, dealt with and controlled.

1. **Recognize that you are procrastinating.** Be honest with yourself; you probably know when you are procrastinating.
2. **Work out why you are procrastinating.** Why you procrastinate can depend on both you and the task. Understanding the reason for procrastination for each situation will help you select the best approach to overcoming your reluctance to get going.
3. **Get over it.** If you are putting something off because you just do not want to do it, and you can not delegate the work, you need to find a way to motivate yourself. The following approaches may be helpful:
 - make up your own rewards;
 - ask someone to check up on you; or
 - identify unpleasant consequences of not doing the task.

If you are putting off starting a project because you find it overwhelming, you may need a different approach. Here are some tips:

- break the project into smaller, or manageable tasks;
- start with some quick small tasks, even if these are not the logical place to start. This will help you feel like you are achieving results.

CONDUCT AN ACTIVITY WHERE CADETS BRAINSTORM TIME-MANAGEMENT TIPS

ACTIVITY

Time: 10 min

OBJECTIVE

The objective of this activity is to have the cadets brainstorm time-management tips.

RESOURCES

- Flipchart, and
- Marker.

ACTIVITY LAYOUT

Nil.

ACTIVITY INSTRUCTIONS

1. Divide the cadets into groups of no more than six.
2. Have the cadets select a recorder for the brainstorming session.
3. Explain to cadets that they are to create a list of time-management tips for other cadets.
4. Have the selected cadet record the suggestions.
5. Have each group share their tips with the rest of the class.

SAFETY

Nil.

EXPLAIN TIME-MANAGEMENT TIPS FOR TEENS

Time: 5 min

If it seems like there is never enough time in the day to get everything done, use the following tips to organize and take control of the situation:

- make a to-do list;
- use spare minutes wisely;
- it's okay to say "No";
- find the right and best time for work;
- get a good night's sleep;
- communicate the schedule to others;
- create a time budget and plan accordingly;
- don't waste time agonizing; get on with it; and
- set realistic goals.

EXPLAIN HOW TO PREPARE TO-DO LISTS

Time: 5 min

A to-do list is a prioritized list of tasks that need to be completed. It lists what must be done with the important tasks at the top of the list and the least important tasks at the bottom of the list.

Keeping to-do lists ensures that all tasks that need to be accomplished are captured in one place. This is essential in order not to forget things. By prioritizing work, a plan is created. This ensures that tasks that need immediate attention are completed first.

Preparing a To-do List

Begin by writing down all of the tasks that need to be completed. If the tasks are large, break them into parts. All tasks on the list should take no more than 1–2 hours to complete.

How to Prioritize the To-do List

The next step in creating a useful to-do list is to prioritize each task on the to-do list. There are many ways to prioritize but usually priorities are based on time constraints and / or the benefit of the accomplishment of the task. For example, a priority based on time constraints could be if you have to take a sibling to a ball game at six in the evening, and the clock reads 5:30 pm, that task will move to a very high priority. An example based on a benefit of the task could be if you wish to buy a newer car, you cannot miss shifts at work. Shifts at work will have a very high priority.

Allocate priorities for each task from A (very important or very urgent) to F (unimportant or not urgent at all). If too many tasks have a high priority, go through the to-do list again and demote the less important tasks. Once this has been accomplished, rewrite the list in order of priority.

CONDUCT A GROUP DISCUSSION ON HOW TECHNOLOGY MAY AID IN TIME MANAGEMENT

Time: 5 min

GROUP DISCUSSION



TIPS FOR ANSWERING / FACILITATING DISCUSSION:

- Establish ground rules for discussion, eg, everyone should listen respectfully; don't interrupt; only one person speaks at a time; no one's ideas should be made fun of; you can disagree with ideas but not with the person; try to understand others as much as you hope they understand you; etc.
- Sit the group in a circle, making sure all cadets can be seen by everyone else.
- Ask questions that will provoke thought; in other words avoid questions with yes or no answers.
- Manage time by ensuring the cadets stay on topic.
- Listen and respond in a way that indicates you have heard and understood the cadet. This can be done by paraphrasing their ideas.
- Give the cadets time to respond to your questions.
- Ensure every cadet has an opportunity to participate. One option is to go around the group and have each cadet answer the question with a short answer. Cadets must also have the option to pass if they wish.
- Additional questions should be prepared ahead of time.

SUGGESTED QUESTIONS:

- Q1. What types of technology may help in time-management?
- Q2. How can those technologies help?

Q3. Do you use technologies to help keep you on track and organized?

Q4. How do they help you?



Other questions and answers will develop throughout the group discussion. The group discussion should not be limited to only those suggested.



Reinforce those answers given and comments made during the group discussion, ensuring the teaching point has been covered.

**CONDUCT AN IN-CLASS ACTIVITY WHERE CADETS
CREATE A TO-DO LIST BASED ON A SCENARIO**

ACTIVITY

Time: 15 min

OBJECTIVE

The objective of this activity is to have the cadets create a to-do list based on a scenario.

RESOURCES

- Scenario located at Appendix 1 to Attachment C,
- Paper, and
- Pen / pencil.

ACTIVITY LAYOUT

Nil.

ACTIVITY INSTRUCTIONS

1. Distribute the scenario to each cadet.
2. Have cadets create a to-do list based on the scenario.
3. Have cadets present their to-do list to the group, and explain why they prioritized their list the way they did.

SAFETY

Nil.

CONDUCT A GROUP DISCUSSION ON THE TIME-MANAGEMENT SEMINAR

Time: 5 min

BACKGROUND KNOWLEDGE



The purpose of the group discussion is to have cadets practice reflective thinking skills. Use the tips for answering / facilitating discussion and the suggested questions provided.

GROUP DISCUSSION



TIPS FOR ANSWERING / FACILITATING DISCUSSION:

- Establish ground rules for discussion, eg, everyone should listen respectfully; don't interrupt; only one person speaks at a time; no one's ideas should be made fun of; you can disagree with ideas but not with the person; try to understand others as much as you hope they understand you; etc.
- Sit the group in a circle, making sure all cadets can be seen by everyone else.
- Ask questions that will provoke thought; in other words avoid questions with yes or no answers.
- Manage time by ensuring the cadets stay on topic.
- Listen and respond in a way that indicates you have heard and understood the cadet. This can be done by paraphrasing their ideas.
- Give the cadets time to respond to your questions.
- Ensure every cadet has an opportunity to participate. One option is to go around the group and have each cadet answer the question with a short answer. Cadets must also have the option to pass if they wish.
- Additional questions should be prepared ahead of time.

SUGGESTED QUESTIONS:

- Q1. What have you learned during this seminar?
- Q2. Which activities did you enjoy during the seminar? Why?
- Q3. Will this information be useful to you?
- Q4. Where do you think you will use the information from this seminar?



Other questions and answers will develop throughout the group discussion. The group discussion should not be limited to only those suggested.



Reinforce those answers given and comments made during the group discussion, ensuring the teaching point has been covered.

THIS PAGE INTENTIONALLY LEFT BLANK

SCENARIO FOR CREATING A TO-DO LIST

It is Friday morning at 8:00 am. All tasks must be completed by 8:00 am on Monday.

The following tasks must be accomplished. Create a to-do list in priority order.

- Go to school from 9:00 am to 3:00 pm on Friday.
- Work from 6:00 pm to 9:00 pm on Saturday night.
- Pick up your sister from ballet on Sunday at 1:00 pm.
- Clean your room.
- Polish your boots.
- Take out the garbage.
- Make a lesson plan for cadets on Monday night.
- Go to a movie.
- Hang out with your friends.
- Cut the lawn.
- Do your homework which includes a 1 000 word essay, four math problems, and reading two chapters of your history text.
- Play basketball on Saturday.
- Update your resume.
- Have supper at your grandparents on Sunday.
- Study for final exams.
- Eat meals.
- Sleep at least eight hours a night.
- Work out with weights.

THIS PAGE INTENTIONALLY LEFT BLANK

LEADERSHIP SEMINAR COMMUNICATIONS

Total Time:

90 min

PREPARATION

Photocopy Appendices 1 and 3 to Attachment D for each cadet.

Photocopy Appendices 2 to Attachment D.

The following components are conducted during this seminar:

Number	Component	Time
1	Have cadets participate in a communication exercise.	15 min
2	Conduct a group discussion on the communications exercise.	5 min
3	Demonstrate and explain how to build rapport using a role-play scenario.	20 min
4	Explain reading body language.	15 min
5	Conduct an activity where cadets read negative and positive body language.	20 min
6	Conduct a group discussion on the communications seminar.	5 min

HAVE CADETS PARTICIPATE IN A COMMUNICATION EXERCISE

ACTIVITY

Time: 15 min

OBJECTIVE

The objective of this activity is to have the cadets give and receive instructions without non-verbal cues.

RESOURCES

- Figures located at Appendix 1 to Attachment D,
- Paper, and
- Pens / pencil.

ACTIVITY LAYOUT

Nil.

ACTIVITY INSTRUCTIONS

1. Have the cadets find a partner.
2. Have the cadets sit back-to-back.
3. Distribute paper and pen / pencil to each cadet.
4. Distribute picture A to one cadet and picture B to the other cadet.

5. Have the first cadet describe and give instructions to the other cadet to reproduce picture A. The cadet receiving instructions cannot ask for clarification; they may only ask for repetition.
6. Allow the first cadet seven minutes to complete the instructions.
7. Have the other cadet describe and give instructions to the first cadet to reproduce picture B. The cadet receiving instructions cannot ask for clarification; they may only ask for repetition.
8. Allow the second cadet seven minutes to complete the instructions.
9. Have each cadet exchange pictures.

SAFETY

Nil.

CONDUCT A GROUP DISCUSSION ON THE COMMUNICATIONS EXERCISE

Time: 5 min



The purpose of the group discussion is to have cadets practice reflective thinking skills. Use the tips for answering / facilitating discussion and the suggested questions provided.

GROUP DISCUSSION



TIPS FOR ANSWERING / FACILITATING DISCUSSION:

- Establish ground rules for discussion, eg, everyone should listen respectfully; don't interrupt; only one person speaks at a time; no one's ideas should be made fun of; you can disagree with ideas but not with the person; try to understand others as much as you hope they understand you; etc.
- Sit the group in a circle, making sure all cadets can be seen by everyone else.
- Ask questions that will provoke thought; in other words avoid questions with yes or no answers.
- Manage time by ensuring the cadets stay on topic.
- Listen and respond in a way that indicates you have heard and understood the cadet. This can be done by paraphrasing their ideas.
- Give the cadets time to respond to your questions.
- Ensure every cadet has an opportunity to participate. One option is to go around the group and have each cadet answer the question with a short answer. Cadets must also have the option to pass if they wish.
- Additional questions should be prepared ahead of time.

SUGGESTED QUESTIONS:

- Q1. How did you feel about giving instructions? Were your instructions to the point?
- Q2. How did you feel about receiving instructions? Could the instructions you were given be more clear?
- Q3. Which was more difficult, giving or receiving instruction? Why?
- Q4. Would this exercise have been easier if you could see your partner? Why or why not?



Other questions and answers will develop throughout the group discussion. The group discussion should not be limited to only those suggested.



Reinforce those answers given and comments made during the group discussion, ensuring the teaching point has been covered.

DEMONSTRATE AND EXPLAIN HOW TO BUILD RAPPORT USING A ROLE-PLAY SCENARIO

BACKGROUND KNOWLEDGE

BUILDING RAPPORT

Rapport builds naturally over time with cadets who are trusted and who are believable. The process of building rapport can be sped up by matching and mirroring the other cadet's verbal and non-verbal communications.

Matching Body Language

Matching body language can take several forms. One may match the other cadet's whole body position, the position of the upper or lower half of their body, or the angle of their head and shoulder. Matching may also be done by using the cadet's same type and rate of movement and gestures. One may match things exactly or partially.

Matching Voice

Matching may also be done using the other cadet's voice. One may match their volume, speed, pitch, rhythm, inflections and pauses. One may match their type of language and vocabulary and speech patterns.

Matching Energy

One may match the other cadet's energy level also. One may match how rapidly they breathe and whether they breathe using shallow or deep breaths.

Mirroring

Instead of matching the cadet's body movements, one may mirror them. When the cadet crosses their right leg over their left, one may cross their left leg over their right.

The idea of building rapport through matching and mirroring is not to copy blindly every movement a cadet makes or each body position they sit in. Building rapport is something that is done "with" a cadet, not "to" a cadet.

ACTIVITY

Time: 20 min



When conducting the role-play, take the part of a mentor. Ensure when acting as the mentor during the role-play to use matching and mirroring techniques.

OBJECTIVE

The objective of this activity is to have the cadets see communications that build rapport using a role-play scenario.

RESOURCES

- Role-play scenario located at Appendix 2 to Attachment D,
- Paper,
- Pen/ pencil.

ACTIVITY LAYOUT

Nil.

ACTIVITY INSTRUCTIONS

1. Distribute paper and a pen / pencil to each cadet.
2. Ask cadets to volunteer to take part in the role-play.
3. Select one cadet to take part in the role-play.
4. Distribute the role-play scenario to the selected cadet.
5. Ask all other cadets to write down their observations about the role-play scenario.
6. Conduct the role-play scenario with the selected cadet.
7. After eight minutes, conclude the role-play scenario.
8. Have the rest of the cadets share their observations about the scenario. Ensure the cadets give examples for their observations.
9. Describe the matching and mirroring techniques that were used during the role-play scenario.

SAFETY

Nil.

EXPLAIN READING BODY LANGUAGE

Time: 15 min

Body language reveals a cadet's true thoughts. It may forewarn problems, such as lack of understanding, disagreement or conflict. It may signal support, agreement or encouragement. It may show how comfortable a cadet is with what is being said or how committed they really are to their own words.

Reading Other's Body Language

Most people understand body language intuitively and quickly, and the conclusions that are reached go straight into the subconscious. However, it pays to look out for certain positive and negative signals. If other's body language is read correctly, one should know whether one's communications are succeeding or missing their mark.

The Signal	What it may say
Nodding the head.	This cadet is listening to me. This cadet agrees with me.
Scratching the neck or rubbing eyes and looking at the ceiling (female) or the floor (man).	This cadet may not be telling the truth.
Clenched hands.	This cadet is frustrated.
Hand on cheek.	This cadet has some doubts.
Hand on cheek with thumb under chin.	This cadet is interested but has some doubts.
Picking off imaginary lint.	This cadet disagrees with or disproves of what has been said but is not willing to say so.
Crossed arms and legs.	This cadet is tuning out or filtering what is being said.

One must be careful of a cadet's unspoken messages. Crossed arms may say "I feel threatened by what you are saying and I am closed to hearing it", but it may also say "I'm cold". A tapping foot may mean "I would like to be on my way", but it may also reflect a lot of nervous energy or a need to go to the washroom.

Look Out for Negative Signals

A cadet's body language may serve as an early warning signal that something is amiss in the communication process. Negative signals include:

Boredom may look like:

- feet pointing away from the speaker;
- tapping feet;
- rapidly nodding the head;
- covering the nose;
- rubbing or scratching the neck or nose;
- looking skyward;
- avoiding or limiting eye contact;
- covering the mouth;
- body orienting away from the speaker;
- tense posture;
- covering or rubbing of the ears;
- "dancing" around;
- forming a fist, clenching the hands;
- rapidly exhaling breath;
- fidgeting (eg, tapping a pencil);
- drumming the fingers on the table; and
- buttoning the coat or jacket.

Boredom may look like:

- doodling;
- drumming the fingers;
- crossed legs with the foot swinging or kicking;
- head held in hands;
- a blank stare;
- taking deep breaths;
- tapping the floor with the foot; and
- clicking a pen in and out.

Frustration may look like:

- short breaths;
- "tssk" sounds;
- hands tightly clenched;
- fist-like gestures;
- wringing hands;
- pointing index fingers;
- running hands through the hair;
- rubbing the back of the neck; and
- kicking the ground at an imaginary object.

Look Out for Positive Signals

Just as body language may alert one to looming problems, it may also herald success. Positive signals include:

- nodding thoughtfully;
- relaxed posture;
- body oriented toward the speaker;
- open hands;
- feet pointed towards the speaker;
- stroking of the chin;
- open body position;
- eye contact, particularly when the pupils are dilated (enlarged);
- handling the documents or materials one is presenting; and
- thoughtful "um-hums".

Cooperation may look like:

- open hands;
- sitting on the edge of the chair;
- unbuttoning the coat or jacket;
- tilted head;
- leaning toward the speaker; and
- moving closer to the speaker.

Evaluation may look like:

- hand-to-face gestures;
- tilted head;
- stroking the chin or chin in the palm of the hand;
- taking their glasses off to clean them;
- sucking on a pen or glasses' arm; and
- peering over their glasses.



Distribute Appendix 3 to Attachment D to each cadet.

CONDUCT AN ACTIVITY WHERE CADETS READ NEGATIVE AND POSITIVE BODY LANGUAGE

Time: 20 min

OBJECTIVE

The objective of this activity is to have the cadets read negative and positive body language.

RESOURCES

Nil.

ACTIVITY LAYOUT

Nil.

ACTIVITY INSTRUCTIONS

1. Have cadets select a partner.
2. Select one set of partners to go first.
3. Have one cadet act as the sender while the other cadet acts as the receiver of the information.
4. Have the receiver select one body language signal to display throughout the sender's presentation.
5. Have the sender tell the receiver about everything they have done during the previous week.
6. Have the receiver display the body language selected throughout the sender's presentation.
7. Have the sender talk for approximately two minutes.
8. Have the sender guess what body language was being displayed.
9. Have the rest of the class guess what body language was being displayed.
10. Have the receiver confirm or deny the guesses. If the guesses were not correct, have the receiver explain what body language was being displayed.
11. Repeat Steps 5–10 until each set of partners has been both the sender and the receiver.

SAFETY

Nil.

CONDUCT A GROUP DISCUSSION ON THE COMMUNICATIONS SEMINAR

Time: 5 min



The purpose of the group discussion is to have cadets practice reflective thinking skills. Use the tips for answering / facilitating discussion and the suggested questions provided.

GROUP DISCUSSION



TIPS FOR ANSWERING / FACILITATING DISCUSSION:

- Establish ground rules for discussion, eg, everyone should listen respectfully; don't interrupt; only one person speaks at a time; no one's ideas should be made fun of; you can disagree with ideas but not with the person; try to understand others as much as you hope they understand you; etc.
- Sit the group in a circle, making sure all cadets can be seen by everyone else.
- Ask questions that will provoke thought; in other words avoid questions with yes or no answers.
- Manage time by ensuring the cadets stay on topic.
- Listen and respond in a way that indicates you have heard and understood the cadet. This can be done by paraphrasing their ideas.
- Give the cadets time to respond to your questions.
- Ensure every cadet has an opportunity to participate. One option is to go around the group and have each cadet answer the question with a short answer. Cadets must also have the option to pass if they wish.
- Additional questions should be prepared ahead of time.

SUGGESTED QUESTIONS:

- Q1. What have you learned during this seminar?
- Q2. Which activities did you enjoy during the seminar? Why?
- Q3. Will this information be useful to you?
- Q4. Where do you think you will use the information from this seminar?



Other questions and answers will develop throughout the group discussion. The group discussion should not be limited to only those suggested.



Reinforce those answers given and comments made during the group discussion, ensuring the teaching point has been covered.

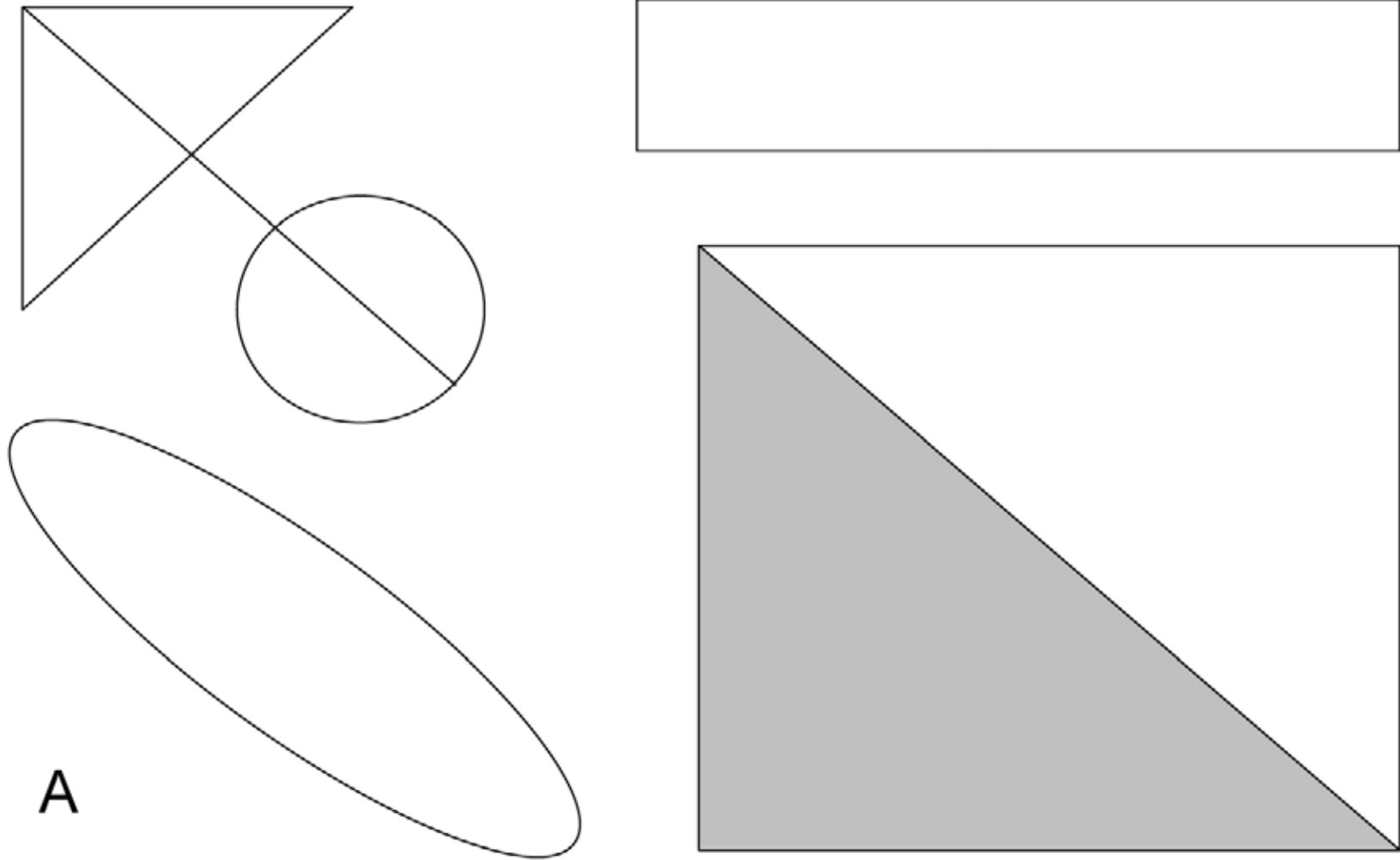

A

Figure D1-1 Picture A

Note. Created by Director Cadets 3, 2009, Ottawa, ON: Department of National Defence

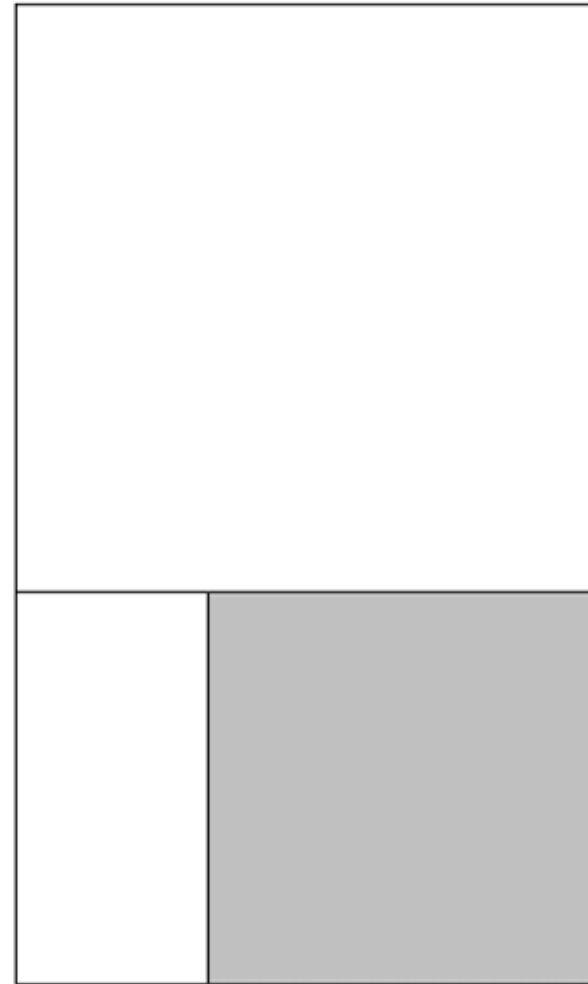
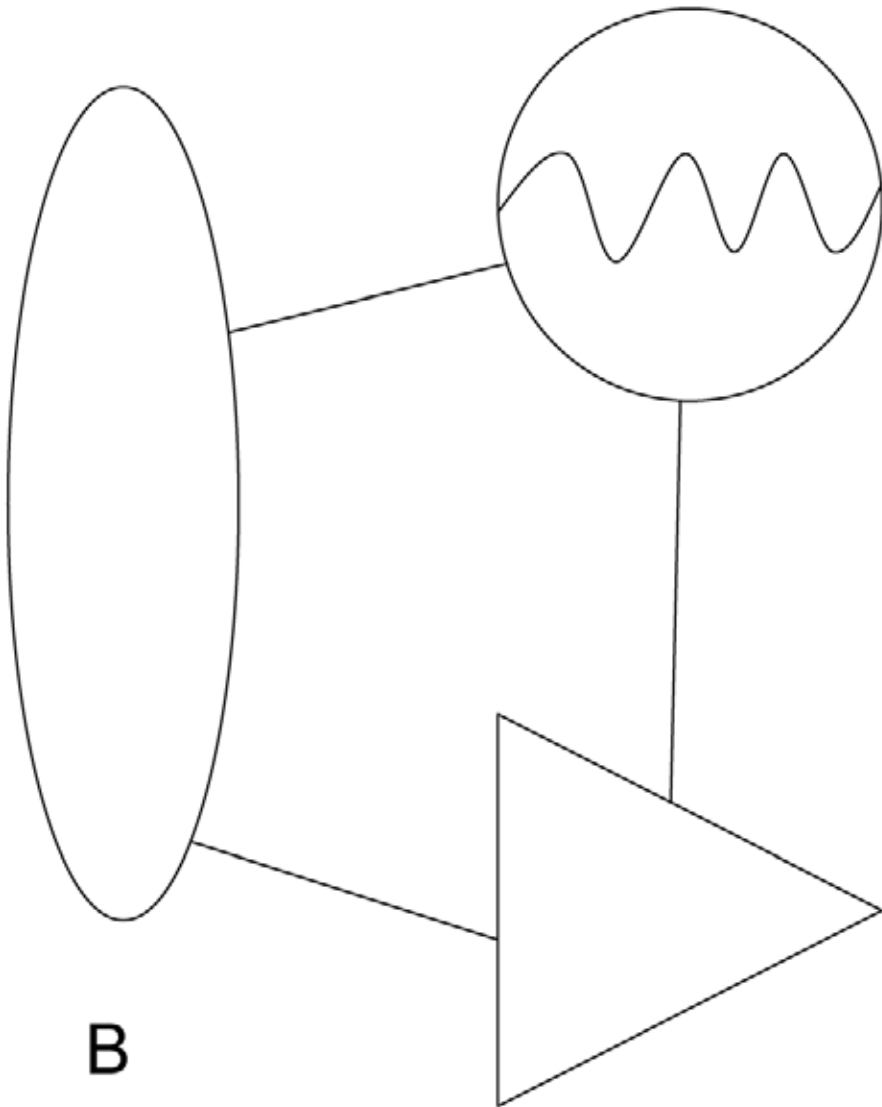

Figure D1-2 Picture B

Note. Created by Director Cadets 3, 2009, Ottawa, ON: Department of National Defence

SCENARIO FOR ROLE-PLAY

You are a second year cadet who is often timid and shy. You are often late to parade nights and you do not take care of your uniform very well. You attended the General Training (GT) course last summer and this summer you wish to attend the three-week Basic Musician Course.

THIS PAGE INTENTIONALLY LEFT BLANK

READING BODY LANGUAGE

Body language reveals a cadet's true thoughts. It may forewarn problems, such as lack of understanding, disagreement or budding conflict. It may signal support, agreement or encouragement. It may show how comfortable a cadet is with what is being said or how committed they really are to their own words.

Reading Other's Body Language

Most people understand body language intuitively and quickly, and the conclusions that are reached go straight into the subconscious. However, it pays to look out for certain positive and negative signals. If other's body language is read correctly, one should know whether one's communications are succeeding or missing their mark.

The Signal	What it may say
Nodding the head.	This cadet is listening to me. This cadet agrees with me.
Scratching the neck or rubbing eyes and looking at the ceiling (female) or the floor (man).	This cadet may not be telling the truth.
Clenched hands.	This cadet is frustrated.
Hand on cheek.	This cadet has some doubts.
Hand on cheek with thumb under chin.	This cadet is interested but has some doubts.
Picking off imaginary lint.	This cadet disagrees with or disproves of what has been said but is not willing to say so.
Crossed arms and legs.	This cadet is tuning out or filtering what is being said.

One must be careful of a cadet's unspoken messages. Crossed arms may say "I feel threatened by what you are saying and I am closed to hearing it", but it may also say "I'm cold". A tapping foot may mean "I would like to be on my way", but it may also reflect a lot of nervous energy or a need to go to the washroom.

Look Out for Negative Signals

A cadet's body language may serve as an early warning signal that something is amiss in the communication process. Negative signals include:

- feet pointing away from the speaker;
- tapping feet;
- rapidly nodding the head;
- covering the nose;
- rubbing or scratching the neck or nose;
- looking skyward;
- avoiding or limiting eye contact;
- covering the mouth;
- body orienting away from the speaker;
- tense posture;
- covering or rubbing of the ears;
- "dancing" around;
- forming a fist, clenching the hands;
- rapidly exhaling breath;
- fidgeting (eg, tapping a pencil);
- drumming the fingers on the table; and
- buttoning the coat or jacket.

Boredom may look like:

- doodling;
- drumming the fingers;
- crossed legs with the foot swinging or kicking;
- head held in hands;
- a blank stare;
- taking deep breaths;
- tapping the floor with the foot; and
- clicking a pen in and out.

Frustration may look like:

- short breaths;
- "tssk" sounds;
- hands tightly clenched;
- fist-like gestures;
- wringing hands;
- pointing index fingers;
- running hands through the hair;
- rubbing the back of the neck; and
- kicking the ground at an imaginary object.

Look Out for Positive Signals

Just as body language may alert one to looming problems, it may also herald success. Positive signals include:

- nodding thoughtfully;
- relaxed posture;
- body oriented toward the speaker;
- open hands;
- feet pointed towards the speaker;
- stroking of the chin;
- open body position;
- eye contact, particularly when the pupils are dilated (enlarged);
- handling the documents or materials one is presenting; and
- thoughtful "um-hums".

Cooperation may look like:

- open hands;
- sitting on the edge of the chair;
- unbuttoning the coat or jacket;
- tilted head;
- leaning toward the speaker; and
- moving closer to the speaker.

Evaluation may look like:

- hand-to-face gestures;
- tilted head;
- stroking the chin or chin in the palm of the hand
;
- taking their glasses off to clean them;
- sucking on a pen or glasses' arm; and
- peering over their glasses.

LEADERSHIP SEMINAR SUPERVISION

Total Time:

90 min

PREPARATION

Photocopy Appendices 1 and 2 to Attachment E for each cadet.

The following components are conducted during this seminar:

Number	Component	Time
1	Describe supervision systems.	10 min
2	Explain how to supervise effectively.	15 min
3	Conduct a group discussion on supervision.	25 min
4	Conduct an activity where cadets create a supervision plan based on a scenario.	25 min
5	Conduct a group discussion on the supervision seminar.	5 min

DESCRIBE SUPERVISION SYSTEMS

Time: 10 min

In general, the system of supervision will vary according to:

- the type of activity,
- the location of the activity,
- the age and skill of cadets, and
- the age and skill of the team leader / supervisor.

An assessment of the situation will determine the most appropriate supervision system to ensure the safety of cadets. The following systems may be used to cater to various situations.

Direct and Constant Supervision

Some activities require direct and constant supervision by a team leader to ensure all cadets remain safe. To determine whether direct and constant supervision is required, an assessment must be made on the level or risk involved in the activity and the skills and development of the cadets participating in the activity.

Intermittent Supervision

Intermittent supervision is appropriate for the supervision of more mature, responsible cadets participating in low-risk activities. Intermittent supervision must be well planned. The expectations for the cadets must be clearly stated and the cadets must be checked regularly.

Area Supervision

Area supervision requires a team leader to take responsibility for a particular area such as a basketball court or dining area. Area supervision allows cadets to move freely between areas and is easy to manage and plan.

Group Supervision

Group supervision relates to the supervision of a group of cadets regardless of the area they are in. Group supervision is more useful on excursions to venues where it is more difficult to supervise a large group of cadets or allow cadets to be grouped according to interest or skill level.

Floater Supervision

Floater supervision refers to a system where a team leader moves among all areas supporting and encouraging cadets and staff. The floater keeps track of the big picture and does not monitor a specific area or activity.

EXPLAIN HOW TO SUPERVISE EFFECTIVELY

Time: 15 min

Being totally aware of what is happening around and beyond a specific activity requires the development of specific supervision skills. These skills include:

- scanning;
- positioning;
- listening; and
- being "with it".

Scanning

Scanning involves regularly glancing around the whole area to see what is happening. By continually scanning the area, the team leader is able to quickly intervene in a situation where cadets could be at risk or intervene in a dispute.

Positioning

The physical position that the team leader takes will determine how well the team leader is able to supervise the cadets in their vicinity. Always position the body to be able to observe the maximum area possible. If the team leader is responsible for a high-risk activity, they must never leave the activity.

Listening

As well as positioning and scanning the area, the team leader will need to listen carefully to what is happening. As the team leader listens to cadets, they will learn the sounds that indicate that all is well or sounds that indicate something is not right.

Being "With It"

Being "with it" is the key to any supervision system. It is the desire and ability to be aware of:

- what has happened in the past;
- what is happening in the present; and
- what is likely to happen in the future.

Being "with it" requires the team leader to know the cadets in their care and monitor what they are doing. This includes all cadets' range of skills, interests, and their ability to interact with others. Being "with it" may enable the team leader to be aware of the positive behaviour displayed by cadets. The team leader may notice the leadership, perseverance, cooperation, and kindness of cadets.



Distribute Appendix 1 to Attachment E to each cadet.

CONDUCT A GROUP DISCUSSION ON SUPERVISION

Time: 25 min



The purpose of the group discussion is to have cadets practice reflective thinking skills. Use the tips for answering / facilitating discussion and the suggested questions provided.

GROUP DISCUSSION



TIPS FOR ANSWERING / FACILITATING DISCUSSION:

- Establish ground rules for discussion, eg, everyone should listen respectfully; don't interrupt; only one person speaks at a time; no one's ideas should be made fun of; you can disagree with ideas but not with the person; try to understand others as much as you hope they understand you; etc.
- Sit the group in a circle, making sure all cadets can be seen by everyone else.
- Ask questions that will provoke thought; in other words avoid questions with yes or no answers.
- Manage time by ensuring the cadets stay on topic.
- Listen and respond in a way that indicates you have heard and understood the cadet. This can be done by paraphrasing their ideas.
- Give the cadets time to respond to your questions.
- Ensure every cadet has an opportunity to participate. One option is to go around the group and have each cadet answer the question with a short answer. Cadets must also have the option to pass if they wish.
- Additional questions should be prepared ahead of time.

SUGGESTED QUESTIONS:

- Q1. Name some locations around the squadron where the cadets will need to be supervised in the building?
- Q2. How do you supervise these areas?
- Q3. Is supervision of cadets different in the classroom than in the rest of the building? Why or why not?
- Q4. Is supervision of cadets different in the canteen than in the rest of the building? Why or why not?

- Q5. Is supervision of cadets different on the range than in the rest of the building? Why or why not?
- Q6. How will you supervise the areas in the rest of the building (eg, washrooms, stairs, hallways)?
- Q7. Is supervision of cadets different when cadets are participating in an outdoor activity (eg, sailing, expedition, or launching rockets)?
- Q8. Give some examples of how and why the supervision is different?
- Q9. How does supervision lower the risks of those activities?
- Q10. Can supervision duties be delegated to others? Why or why not?



Other questions and answers will develop throughout the group discussion. The group discussion should not be limited to only those suggested.



Reinforce those answers given and comments made during the group discussion, ensuring the teaching point has been covered.

CONDUCT AN ACTIVITY WHERE CADETS CREATE A SUPERVISION PLAN BASED ON A SCENARIO

Time: 25 min

OBJECTIVE

The objective of this activity is to have the cadets create a supervision plan based on a scenario.

RESOURCES

- Scenario located at Appendix 2 to Attachment E,
- Paper, and
- Pen / pencil.

ACTIVITY LAYOUT

Nil.

ACTIVITY INSTRUCTIONS

1. Have the cadets find a partner.
2. Distribute the scenario to each pair of cadets.
3. Allow the cadets 15 minutes to create their supervision plan.
4. Have each pair present their supervision plan to the other cadets.
5. Allow one minute for questions and answers.

SAFETY

Nil.

CONDUCT A GROUP DISCUSSION ON THE SUPERVISION SEMINAR

Time: 5 min



The purpose of the group discussion is to have cadets practice reflective thinking skills. Use the tips for answering / facilitating discussion and the suggested questions provided.

GROUP DISCUSSION



TIPS FOR ANSWERING / FACILITATING DISCUSSION:

- Establish ground rules for discussion, eg, everyone should listen respectfully; don't interrupt; only one person speaks at a time; no one's ideas should be made fun of; you can disagree with ideas but not with the person; try to understand others as much as you hope they understand you; etc.
- Sit the group in a circle, making sure all cadets can be seen by everyone else.
- Ask questions that will provoke thought; in other words avoid questions with yes or no answers.
- Manage time by ensuring the cadets stay on topic.
- Listen and respond in a way that indicates you have heard and understood the cadet. This can be done by paraphrasing their ideas.
- Give the cadets time to respond to your questions.
- Ensure every cadet has an opportunity to participate. One option is to go around the group and have each cadet answer the question with a short answer. Cadets must also have the option to pass if they wish.
- Additional questions should be prepared ahead of time.

SUGGESTED QUESTIONS:

- Q1. What have you learned during this seminar?
- Q2. Which activities did you enjoy during the seminar? Why?
- Q3. Will this information be useful to you?
- Q4. Where do you think you will use the information from this seminar?



Other questions and answers will develop throughout the group discussion. The group discussion should not be limited to only those suggested.



Reinforce those answers given and comments made during the group discussion, ensuring the teaching point has been covered.

SUPERVISION SYSTEMS

In general, the system of supervision will vary according to:

- the type of activity,
- the location of the activity,
- the age and skill of cadets, and
- the age and skill of the team leader / supervisor.

An assessment of the situation will determine the most appropriate supervision system to ensure the safety of cadets. The following systems may be used to cater to various situations.

Direct and Constant Supervision

Some activities require direct and constant supervision by a team leader to ensure all cadets remain safe. To determine whether direct and constant supervision is required, an assessment must be made on the level or risk involved in the activity and the skills and development of the cadets participating in the activity.

Intermittent Supervision

Intermittent supervision is appropriate for the supervision of more mature, responsible cadets participating in low-risk activities. Intermittent supervision must be well planned. The expectations for the cadets must be clearly stated and the cadets must be checked regularly.

Area Supervision

Area supervision requires a team leader to take responsibility for a particular area such as a basketball court or dining area. Area supervision allows cadets to move freely between areas and is easy to manage and plan.

Group Supervision

Group supervision relates to the supervision of a group of cadets regardless of the area they are in. Group supervision is more useful on excursions to venues where it is more difficult to supervise a large group of cadets or allow cadets to be grouped according to interest or skill level.

Floater Supervision

Floater supervision refers to a system where a team leader moves among all areas supporting and encouraging cadets and staff. The floater keeps track of the big picture and does not monitor a specific area or activity.

HOW TO SUPERVISE EFFECTIVELY

Being totally aware of what is happening around and beyond a specific activity requires the development of specific supervision skills. These skills include:

- scanning;
- positioning;
- listening; and
- being "with it".

Scanning

Scanning involves regularly glancing around the whole area to see what is happening. By continually scanning the area, the team leader is able to quickly intervene in a situation where cadets could be at risk or intervene in a dispute.

Positioning

The physical position that the team leader takes will determine how well the team leader is able to supervise the cadets in their vicinity. Always position the body to be able to observe the maximum area possible. If the team leader is responsible for a high-risk activity, they must never leave the activity.

Listening

As well as positioning and scanning the area, the team leader will need to listen carefully to what is happening. As the team leader listens to cadets, they will learn the sounds that indicate that all is well or sounds that indicate something is not right.

Being "With It"

Being "with it" is the key to any supervision system. It is the desire and ability to be aware of:

- what has happened in the past;
- what is happening in the present; and
- what is likely to happen in the future.

Being "with it" requires the team leader to know the cadets in their care and monitor what they are doing. This includes all cadets' range of skills, interests, and their ability to interact with others. Being "with it" may enable the team leader to be aware of the positive behaviour displayed by cadets. The team leader may notice the leadership, perseverance, cooperation, and kindness of cadets.

SCENARIO FOR SUPERVISION PLAN

Your squadron is going on a weekend citizenship tour. The squadron will travel by bus approximately 150 kilometres. The bus will depart Saturday morning at 8:00 am. The first stop for the squadron will be a museum. Lunch will occur at 12:00 pm on site at the museum. The bus will depart the museum and travel to a restaurant for supper at 4:30 pm. The bus will depart the fast food restaurant after one hour to drive to the armoury. The squadron will spend the night sleeping in the armoury. On Sunday morning, breakfast will be brought to the armoury at 08:30 am. The bus will depart the armoury at 10:00 am to drive to a mall. Cadets will have lunch in the mall at the food court. The bus will depart the mall at 2:30 pm to return home.

The squadron will take 15 first year cadets, 10 second year cadets, 7 third year cadets, 4 fourth year cadets, and 2 fifth year cadets. There will be 6 adult supervisors: 4 officers and 2 Civilian Instructors.

Create a supervision plan for the weekend activity using third, fourth and fifth year cadets. Adult supervisors may also be used.

THIS PAGE INTENTIONALLY LEFT BLANK



**COMMON TRAINING
ALL TRAINING LEVELS
INSTRUCTIONAL GUIDE**



PERSONAL FITNESS AND HEALTHY LIVING

SECTION 1

PO X04 – TRACK PARTICIPATION IN PHYSICAL ACTIVITIES

Total Time:

For the following EOs, refer to the lesson specifications located in A-CR-CCP-801/PG-001, *Royal Canadian Air Cadets Proficiency Level One Qualification Standard and Plan*:

- CX04.01 – Participate in the Cadet Fitness Assessment and Identify Strategies for Improving Personal Physical Fitness,
- CX04.03 – Participate in a Cooking Class,
- CX04.04 – Attend a Personal Fitness and Healthy Living Presentation, and
- CX04.05 – Attend a Local Amateur Sporting Event.

For the following EOs, refer to the instructional guides located in A-CR-CCP-801/PF-001, *Royal Canadian Air Cadets Proficiency Level One Instructional Guides*:

- MX04.01 – Participate in 60 Minutes of Moderate- to Vigorous-Intensity Physical Activity (MVPA) and Track Participation in Physical Activities,
- MX04.02 – Identify Strategies to Improve Participation in Physical Activities and Participate in the Cadet Fitness Assessment,
- MX04.03 – Participate in the Cadet Fitness Assessment and Identify Strategies for Improving Personal Physical Fitness, and
- CX04.02 – Participate in Activities that Reinforce the Three Components of Physical Fitness.

THIS PAGE INTENTIONALLY LEFT BLANK



**COMMON TRAINING
ALL TRAINING LEVELS
INSTRUCTIONAL GUIDE
PHYSICAL ACTIVITIES**



SECTION 1

PO X05 – PARTICIPATE IN PHYSICAL ACTIVITIES

Total Time:

For the following EOs, refer to the instructional guides located in A-CR-CCP-801/PF-001, *Royal Canadian Air Cadets Proficiency Level One Instructional Guides*:

- MX05.01 – Participate in Physical Activities,
- CX05.01 – Participate in Physical Activities, and
- CX05.02 – Participate in a Tournament.

THIS PAGE INTENTIONALLY LEFT BLANK



**COMMON TRAINING
PROFICIENCY LEVEL FOUR
INSTRUCTIONAL GUIDE**



SECTION 1

EO M406.01 – PARTICIPATE IN A RECREATIONAL MARKSMANSHIP ACTIVITY

Total Time:

90 min

PREPARATION

PRE-LESSON INSTRUCTIONS

Resources needed for the delivery of this lesson are listed in the lesson specification located in A-CR-CCP-804/PG-001, *Proficiency Level Four Qualification Standard and Plan*, Chapter 4. Specific uses for said resources are identified throughout the instructional guide within the TP for which they are required.

Review the lesson content, unit range standing orders, and become familiar with the material prior to delivering the lesson.

Photocopy the targets located at Attachments B–J as required.

Construct a range IAW A-CR-CCP-177/PT-001, *Canadian Cadet Movement: Cadet Marksmanship Program Reference Manual*.

PRE-LESSON ASSIGNMENT

Nil.

APPROACH

A practical activity was chosen for this lesson as it is an interactive way to allow the cadets to experience recreational marksmanship in a safe and controlled environment. This activity contributes to the development of marksmanship skills and knowledge in a fun and challenging setting.

INTRODUCTION

REVIEW

The review for this lesson will be from EO M106.02 (Carry Out Safety Precautions on the Cadet Air Rifle).

QUESTIONS:

- Q1. Why do we follow safety regulations?
- Q2. How would you verify the safety catch is ON?
- Q3. What are the four “ACTS” of firearm safety?

ANTICIPATED ANSWERS:

- A1. We follow safety regulations to prevent accidents with the cadet air rifle.
- A2. When the safety is ON, no red can be seen.
- A3. The mnemonic “ACTS” stands for:
- Assume every firearm is loaded.
 - Control the muzzle direction at all times.
 - Trigger finger must be kept off the trigger and out of the trigger guard.
 - See that the firearm is unloaded (prove it safe).

OBJECTIVES

By the end of this lesson the cadet shall have participated in a recreational marksmanship activity.

IMPORTANCE

It is important for cadets to participate in a recreational marksmanship activity because it allows them to experience marksmanship in a fun, dynamic and safe setting.

Teaching Point 1**Supervise the cadet's participation in a recreational marksmanship activity.**

Time: 80 min

Method: Practical Activity



A range briefing is conducted to pass on vital information and answer any questions the cadets may have prior to participating in a marksmanship activity. The range briefing is required to ensure the safe execution of a marksmanship activity.

CONDUCT A RANGE BRIEFING

1. Explain pertinent sections of the local range standing orders.
2. Review general rules observed on all ranges, to include:
 - a. proving that rifles are safe prior to being picked up, handed to or received from another person;
 - b. never pointing rifles at people;
 - c. inserting safety rods into the barrels of rifles when not in use on the range;
 - d. never horseplaying on a range;
 - e. always pointing rifles down range; and
 - f. following the Range Safety Officer's (RSO) directions and orders at all times.



Review range commands with an explanation and demonstration for each command.
All loading / firing is to be simulated.

3. Review commands used on an air rifle range (as illustrated in Figure 1).

COMMAND	ACTION TO BE TAKEN
Cover off your firing point	Stand up, move behind the firing point and await further commands.
Place your equipment down and stand back	Lay the equipment down on the mat and stand back when finished.
Adopt the prone position	Adopt the prone position, pick up the rifle, ready the equipment and put on hearing and eye protection.
Type of firing (GRIT)	GRIT is the acronym for: <ol style="list-style-type: none"> 1. Group (relay), 2. Range (distance), 3. Indication (number of rounds), and 4. Type (grouping, scored).

COMMAND	ACTION TO BE TAKEN
Relay, load	<ol style="list-style-type: none"> 1. Pick up and hold the rifle with the dominant hand. 2. Ensure the safety catch is in the "ON" position. 3. Pump the rifle, observing a three-second pause. 4. Load a pellet (flat end forward). 5. Close the bolt.
Relay, fire	<ol style="list-style-type: none"> 1. Place the safety catch in the "OFF" position. 2. Aim the rifle at the target. 3. Squeeze the trigger. 4. Open the bolt. 5. Repeat the following sequence for each shot: <ol style="list-style-type: none"> a. Pump the rifle, observing a three-second pause. b. Load a pellet (flat end forward). c. Close the bolt. d. Aim the rifle at the target. e. Squeeze the trigger. f. Open the bolt. 6. Place the safety in the "ON" position. 7. Partially open the pump lever. 8. Lay down the rifle.

Figure 1 Air Rifle Range Commands

Note. Created by Director Cadets 3, 2006, Ottawa, ON: Department of National Defence.

4. Describe the layout of the air rifle range.
5. Review hand-washing procedures on completion of firing. This is important because each time a person handles pellets, a small trace of lead is left on their hands. To decrease the risk of lead poisoning, it is important that all persons wash their hands thoroughly after handling pellets.

ACTIVITY

OBJECTIVE

The objective of this activity is to have the cadets participate in a recreational marksmanship activity.

RESOURCES

- Cadet air rifle (one per firing lane),
- Cadet air rifle sling (one per cadet),
- Air rifle pellets (as per activity chosen),
- Target frames (one per firing lane),
- Targets (as per activity chosen),
- Shooting mats (one per firing lane),
- Safety glasses / goggles (10 pairs),

- Stopwatch, and
- Pen / pencil.



Additional resources required for specific marksmanship activities may be found in the Attachments.

ACTIVITY LAYOUT

Nil.

ACTIVITY INSTRUCTIONS

1. Brief cadets on the safety rules or any other guidelines pertaining to the activity.
2. Divide the cadets into relays according to the number of firing lanes.
3. Conduct a recreational marksmanship activity, choosing from the following categories:
 - a. classification (located at Attachment A),
 - b. fun activities (located at Attachments B–E),
 - c. timed activities (located at Attachments F–H), or
 - d. competitive team / individual activities (located at Attachments I–J).



If EO C306.03 (Fire the Cadet Air Rifle From the Standing Position) has been taught prior to this marksmanship activity, this EO may be conducted in the standing position.

SAFETY

Range activities will be conducted IAW A-CR-CCP-177/PT-001, *Canadian Cadet Movement: Cadet Marksmanship Program Reference Manual*.

CONFIRMATION OF TEACHING POINT 1

The cadets' participation in the activity will serve as the confirmation of this TP.

END OF LESSON CONFIRMATION

The cadets' participation in the recreational marksmanship activity will serve as the confirmation of this lesson.

CONCLUSION

HOMEWORK / READING / PRACTICE

Nil.

METHOD OF EVALUATION

Nil.

CLOSING STATEMENT

Marksmanship is a fun and exciting activity that requires personal discipline and teamwork skills. This activity has also developed into highly competitive levels at the provincial, regional, and national levels.

INSTRUCTOR NOTES / REMARKS

Hand-washing stations must be available for cleanup after the activity is completed.

Cadets may fire in the standing position if they have received the training associated with EO C306.03 (Fire the Cadet Air Rifle From the Standing Position).

Squadrons choosing to instruct EO C406.01 (Assist the Range Safety Officer) should allow cadets to fill these roles during air rifle marksmanship activities.

This activity provides opportunities for cadets to complete a leadership assignment as outlined in PO 403 (Act as a Team Leader).

REFERENCES

A0-027 A-CR-CCP-177/PT-001 Director Cadets 3. (2005). *Canadian cadet movement: Cadet marksmanship program reference manual*. Ottawa, ON: Department of National Defence.

A0-041 CATO 14-41 Director Cadets 4. (2007). *Marksmanship, rifles and ammunition*. Ottawa ON: Department of National Defence.

CLASSIFICATION ACTIVITY

CLASSIFICATION ACTIVITY

Objective: To provide cadets the opportunity to obtain marksmanship classifications.

Scoring: The standard for the classification levels are:

1. Marksman: Two five-round groupings within a circle of 3 cm in diameter.
2. First Class Marksman: Two five-round groupings within a circle of 2.5 cm in diameter.
3. Expert Marksman: Two five-round groupings within a circle of 2 cm in diameter.
4. Distinguished Marksman: Two five-round groupings within a circle of 1.5 cm in diameter.

Equipment Required:

Mandatory:

- CCT200GRTD Canadian Cadet Movement Air Rifle Grouping Target (one per cadet), and
- Air Rifle Grouping Template from *Canadian Cadet Movement: Cadet Marksmanship Program Reference Manual* (p. B1-1).

Optional aids to firing are limited to the following:

- Cadet air rifle sling,
- Marksmanship jacket,
- Shooting glove, and
- Hat.

Activity Instructions:

1. Distribute an Air Rifle Grouping Target to each cadet.
2. Have the cadets write their name and date on the target and attach it to the target frame.
3. Give the cadets five pellets to fire into the centre of the target.
4. Have the cadets fire, in relays, following the commands given by the RSO.
5. Give the cadets 15 minutes to complete firing.
6. Have the cadets retrieve their targets.
7. Score the targets using the Air Rifle Grouping Template.
8. Record the scores and allow the cadets to keep their targets.

The following are prohibited:

- Alterations made to the rifles,
- A pellet-loading clip,
- Supports used as a rest for the rifle or the forearm,
- A spotting scope,

- Use of sights not provided with the cadet air rifle, and
- Coaching.

FUN ACTIVITIES

PYRAMID

Objective: To fire pellets into each point on the pyramid.

Scoring: One point is awarded for each point on the pyramid that is hit by a pellet.

Equipment Required:

Mandatory: Pyramid Target (one per cadet).

Optional aids to firing are limited to the following:

- Cadet air rifle sling,
- Marksmanship jacket,
- Shooting glove, and
- Hat.

Activity Instructions:

1. Distribute one Pyramid Target to each cadet.
2. Have the cadets write their name and date on the target and attach it to the target frame.
3. Give the cadets three pellets to fire, one pellet into each corner of the pyramid.
4. Have the cadets fire, in relays, following the commands given by the RSO.
5. Give the cadets three minutes to complete firing.
6. Score the targets awarding one point for each corner hit on the pyramid.
7. Allow the cadets to review and keep their targets.

The following are prohibited:

- Alterations made to the rifles,
- A pellet-loading clip,
- Supports used as a rest for the rifle or the forearm,
- A spotting scope, and
- Use of sights not provided with the cadet air rifle.

PYRAMID TARGET

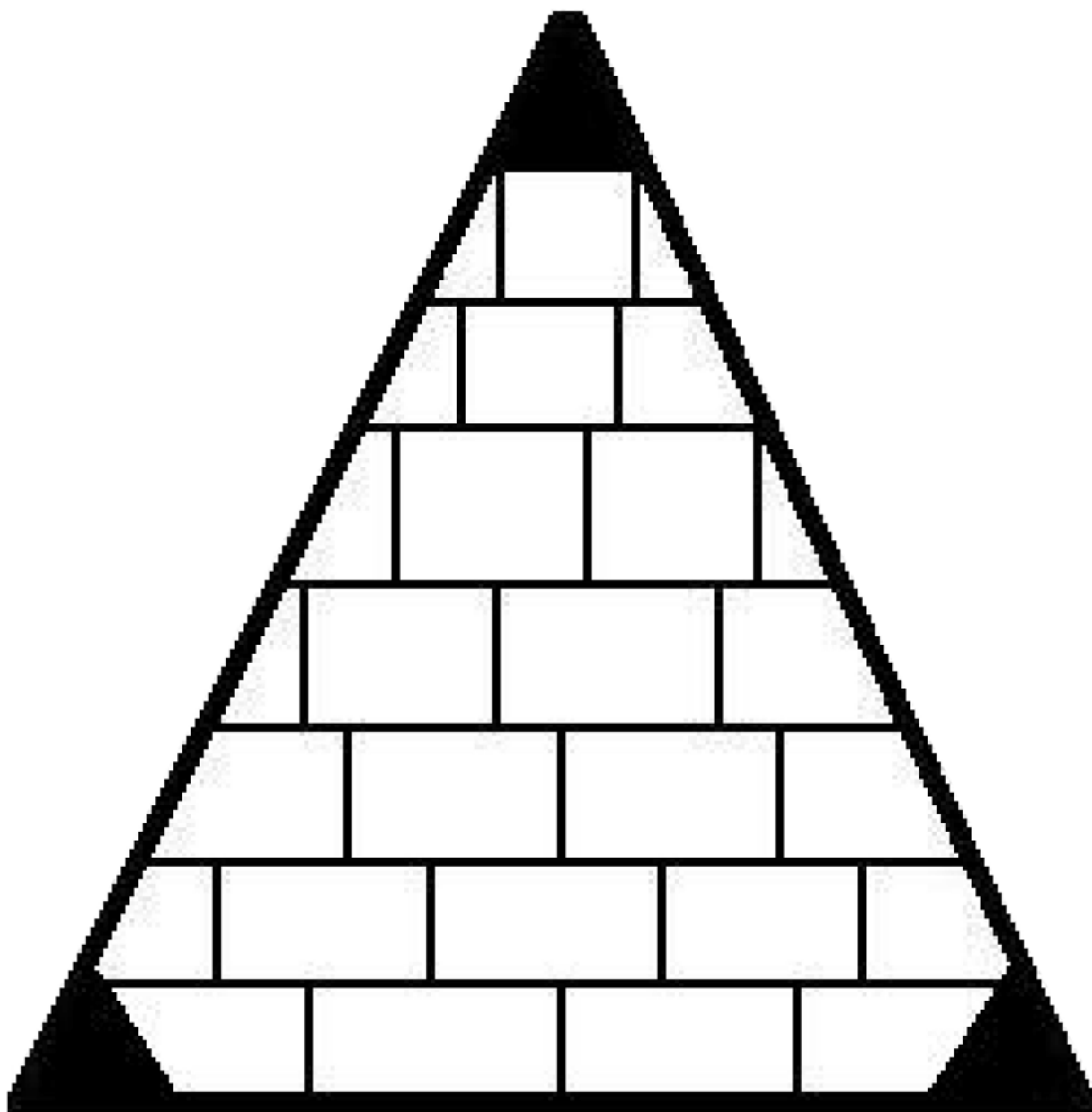

Figure B-1 Pyramid Target

Note. Created by Director Cadets 3, 2007, Ottawa, ON: Department of National Defence.

Name: _____ Date: _____

FUN ACTIVITIES

SHOOTING STAR

Objective: To fire a pellet into each point on the star.

Scoring: One point is awarded for each point on the star that is hit by a pellet.

Equipment Required:

Mandatory: Star Target (one per cadet).

Optional aids to firing are limited to the following:

- Cadet air rifle sling,
- Marksmanship jacket,
- Shooting glove, and
- Hat.

Activity Instructions:

1. Distribute one Star Target to each cadet.
2. Have the cadets write their name and date on the target and attach it to the target frame.
3. Give the cadets five pellets to fire, one pellet into each point on the star.
4. Have the cadets fire, in relays, following the commands given by the RSO.
5. Give the cadets five minutes to complete firing.
6. Score the targets awarding one point for a pellet hit within each point on the star.
7. Allow the cadets to review and keep their targets.

The following are prohibited:

- Alterations made to the rifles,
- A pellet-loading clip,
- Supports used as a rest for the rifle or the forearm,
- A spotting scope, and
- Use of sights not provided with the cadet air rifle.

STAR TARGET



Figure C-1 Star Target

Note. Created by Director Cadets 3, 2007, Ottawa, ON: Department of National Defence.

Name: _____ Date: _____

FUN ACTIVITIES

BEACH BALL

Objective: To fire 10 pellets into the black circle on the beach ball.

Scoring: One point is awarded for each successful hit in the black circle.

Equipment Required:

Mandatory: Beach Ball Target (one per cadet).

Optional aids to firing are limited to the following:

- Cadet air rifle sling,
- Marksmanship jacket,
- Shooting glove, and
- Hat.

Activity Instructions

1. Distribute one Beach Ball Target to each cadet.
2. Have the cadets write their name and date on the target and attach it to the target frame.
3. Give the cadets 10 pellets to fire into the black circle of the beach ball.
4. Have the cadets fire, in relays, following the commands given by the RSO.
5. Give the cadets 10 minutes to complete firing.
6. Score the targets awarding one point for each pellet hit within the black circle.
7. Allow the cadets to review and keep their targets.

The following are prohibited:

- Alterations made to the rifles,
- A pellet-loading clip,
- Supports used as a rest for the rifle or the forearm,
- A spotting scope, and
- Use of sights not provided with the cadet air rifle.

BEACH BALL TARGET



Figure D-1 Beach Ball Target

Note. Created by Director Cadets 3, 2006, Ottawa, ON: Department of National Defence.

Name: _____ Date: _____

FUN ACTIVITIES

BALLOONS

Objective: To fire pellets into balloons on the target.

Scoring: One point is awarded for each balloon hit by a pellet.

Equipment Required:

Mandatory: Balloon Target (one per cadet).

Optional aids to firing are limited to the following:

- Cadet air rifle sling,
- Marksmanship jacket,
- Shooting glove, and
- Hat.

Activity Instructions:

1. Distribute one Balloon Target to each cadet.
2. Have the cadets write their name and date on the target and attach it to the target frame.
3. Give the cadets five pellets to fire, one pellet into each balloon.
4. Have the cadets fire, in relays, following the commands given by the RSO.
5. Give the cadets five minutes to complete firing.
6. Score the targets awarding one point for each balloon hit.
7. Allow the cadets to review and keep their targets.

The following are prohibited:

- Alterations made to the rifles,
- A pellet-loading clip,
- Supports used as a rest for the rifle or the forearm,
- A spotting scope, and
- Use of sights not provided with the cadet air rifle.

Note: Actual balloons may be used in place of the paper targets.

BALLOON TARGET

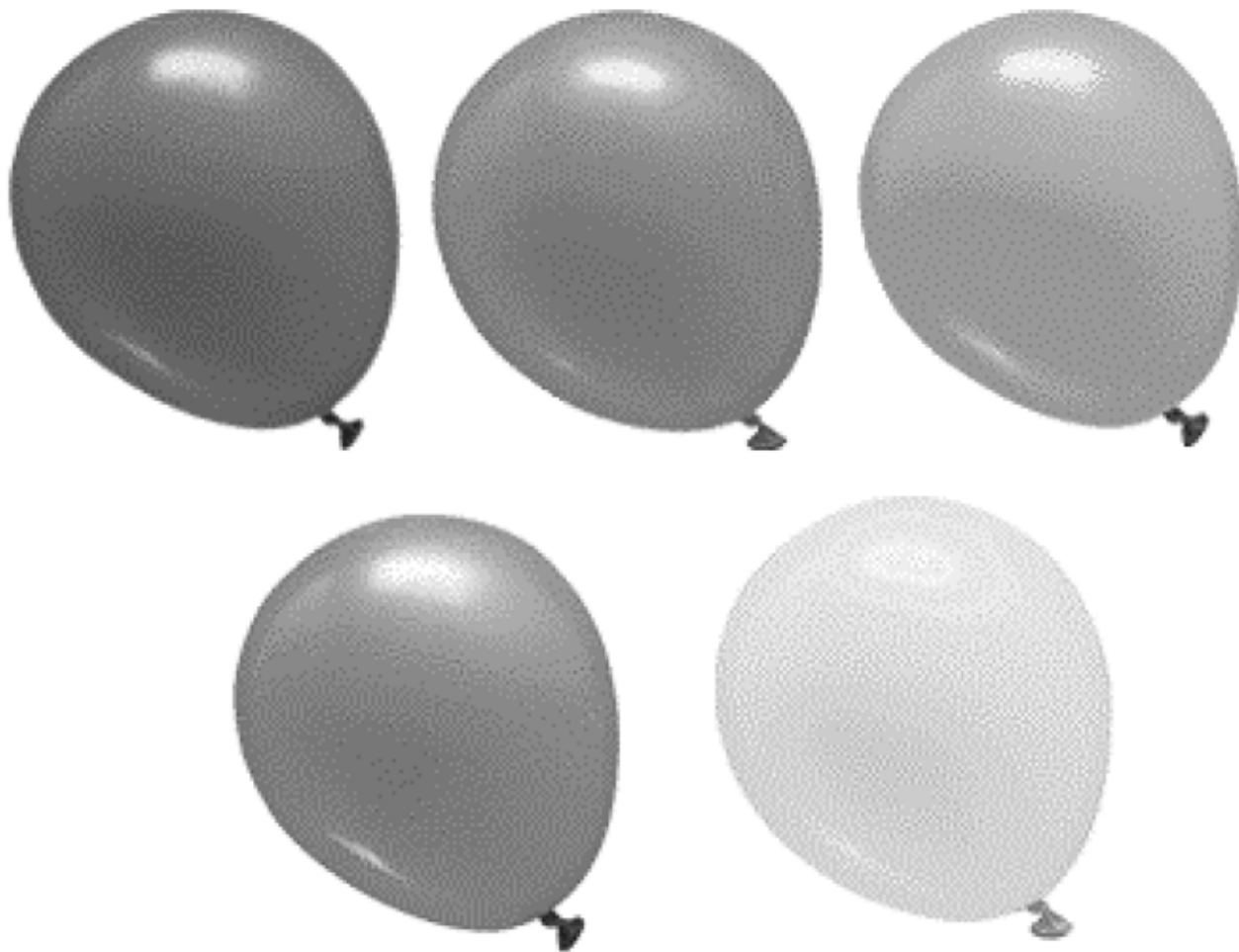

Figure E-1 Balloon Target

Note. Created by Director Cadets 3, 2007, Ottawa, ON: Department of National Defence.

Name: _____ Date: _____

TIMED ACTIVITIES

CHASE THE DOTS

Objective: To fire pellets into the dots on the target in a clockwise direction, within a time limit.

Scoring: One point is awarded for each black dot that is hit by a pellet within the time allotted.

Equipment Required:

Mandatory: Chase the Dots Target (one per cadet).

Optional aids to firing are limited to the following:

- Cadet air rifle sling,
- Marksmanship jacket,
- Shooting glove, and
- Hat.

Activity Instructions:

1. Distribute one Chase the Dots Target to each cadet.
2. Have the cadets write their name and date on the target and attach it to the target frame.
3. Give the cadets eight pellets to fire, one pellet into each black dot, in a clockwise direction.
4. Have the cadets fire, in relays, following the commands given by the RSO.
5. Give the cadets eight minutes to complete firing.
6. Score the targets awarding one point for each black dot hit.
7. Allow the cadets to review and keep their targets.

The following are prohibited:

- Alterations made to the rifles,
- A pellet-loading clip,
- Supports used as a rest for the rifle or the forearm,
- A spotting scope,
- Use of sights not provided with the cadet air rifle, and
- Coaching.

Note: To make this activity more difficult, shorten the time allowance.

CHASE THE DOTS TARGET

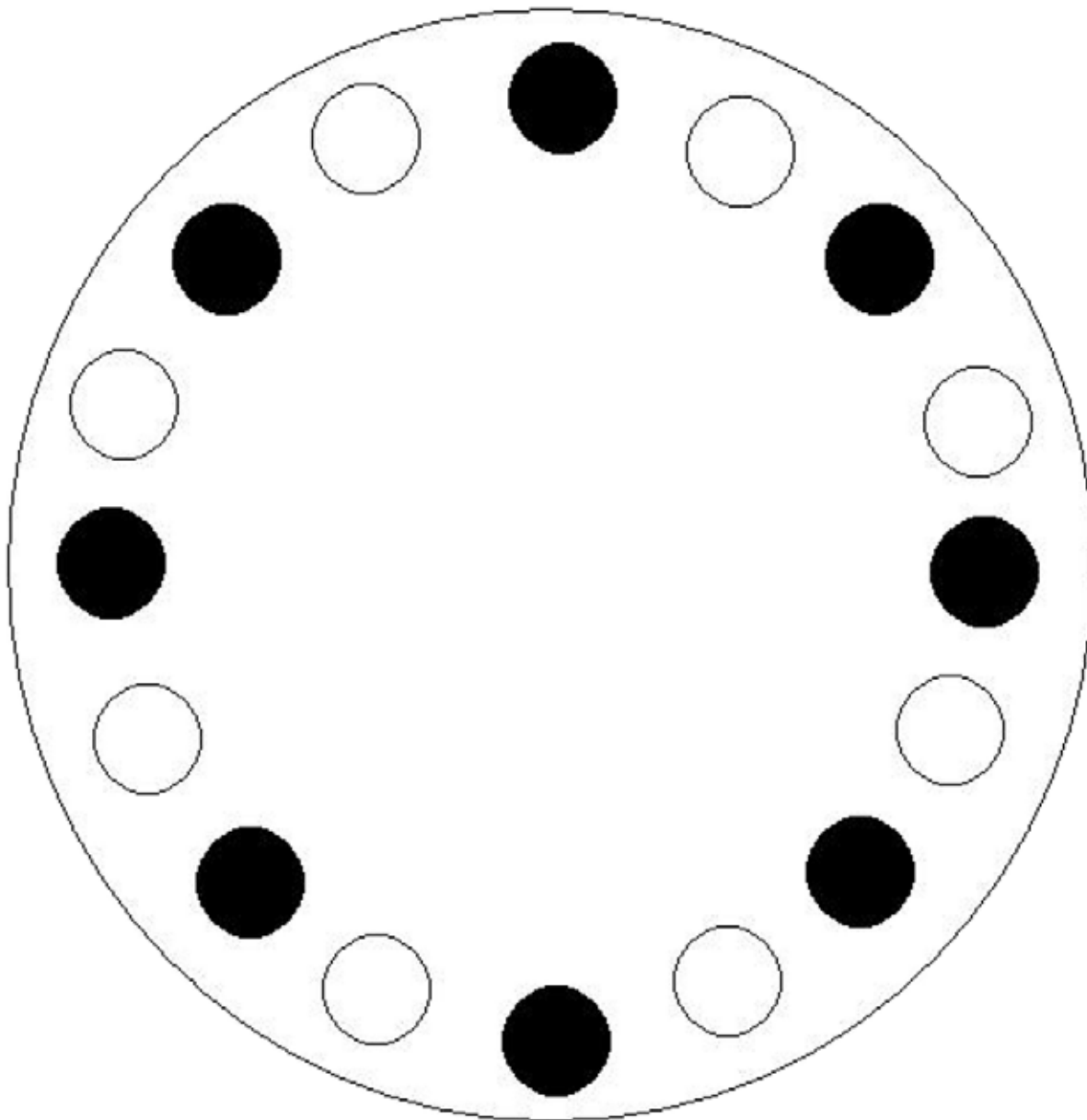

Figure F-1 Chase the Dots Target

Note. Created by Director Cadets 3, 2007, Ottawa, ON: Department of National Defence.

Name: _____ Date: _____

TIMED ACTIVITIES

SPEED GRID

Objective: To fire pellets into the circles on the target, within a time limit.

Scoring: One point is awarded for each circle that is hit by a pellet within the time allotted.

Equipment Required:

Mandatory:

- Cadet air rifle five-pellet clip (three per firing lane), and
- Speed Grid Target (one per cadet).

Optional aids to firing are limited to the following:

- Cadet air rifle sling,
- Marksmanship jacket,
- Shooting glove, and
- Hat.

Activity Instructions:

1. Distribute one Speed Grid Target to each cadet.
2. Have the cadets write their name and date on the target and attach it to the target frame.
3. Give the cadets 15 pellets, pre-loaded into three five-pellet clips.
4. Have the cadets fire one pellet into each circle on the target.
5. Have the cadets fire, in relays, following the commands given by the RSO.
6. Give the cadets 15 minutes to complete firing.
7. Score the targets awarding one point for each circle hit.
8. Allow the cadets to review and keep their targets.

The following are prohibited:

- Alterations made to the rifles,
- Supports used as a rest for the rifle or the forearm,
- A spotting scope,
- Use of sights not provided with the cadet air rifle, and
- Coaching.

Note: To make this activity more difficult, shorten the time allowance.

SPEED GRID TARGET

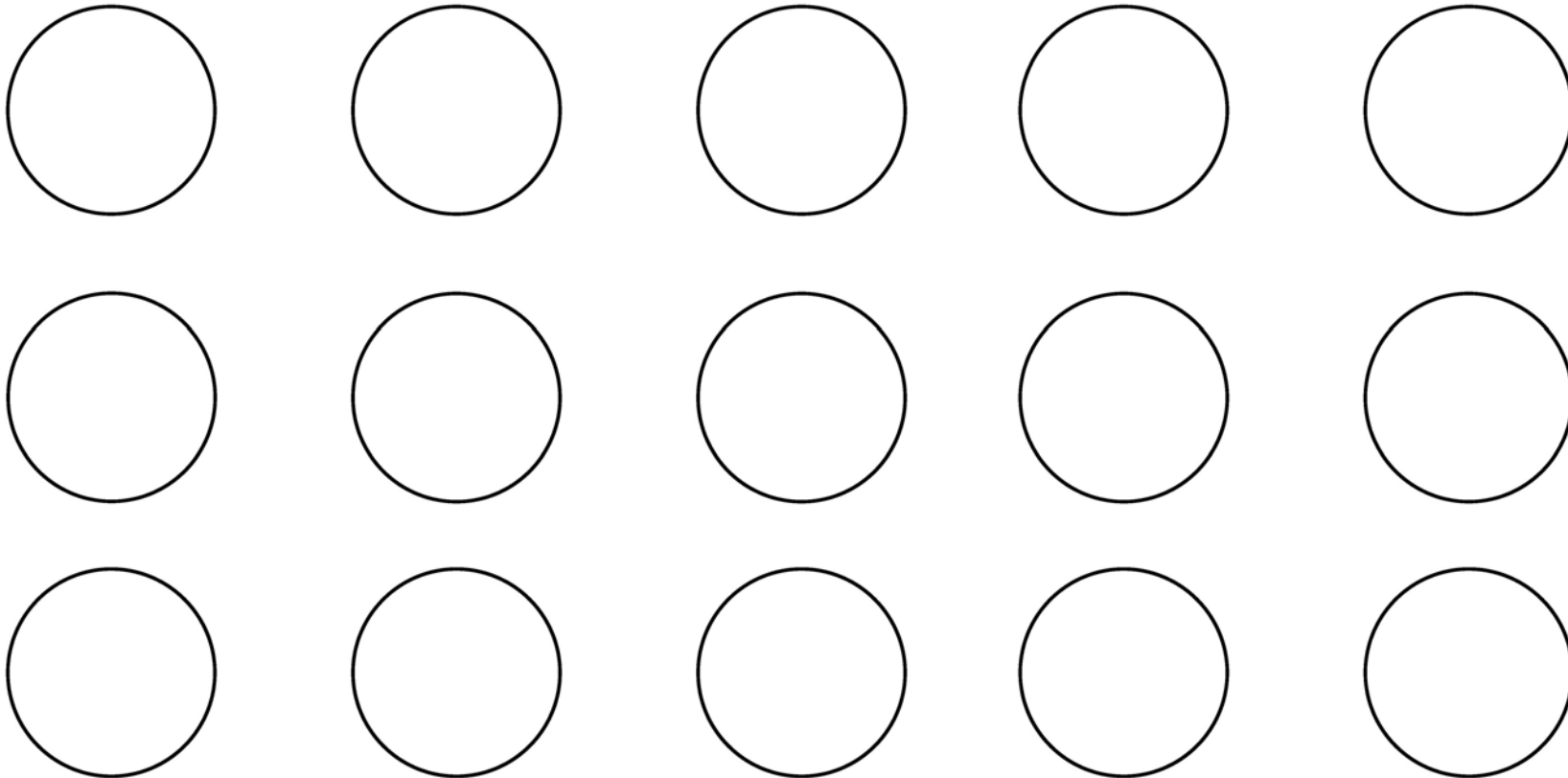

Figure G-1 Speed Grid Target

Note. Created by Director Cadets 3, 2007, Ottawa, ON: Department of National Defence.

Name: _____ Date: _____

TIMED ACTIVITIES

BEAT THE CLOCK

Objective: To fire pellets into the designated hours (numbers) within a time limit.

Scoring: One point is awarded for each correct hour (number) hit by a pellet within the time allotted.

Equipment Required:

Mandatory: Beat the Clock Target (one per cadet).

Optional aids to firing are limited to the following:

- Cadet air rifle sling,
- Marksmanship jacket,
- Shooting glove, and
- Hat.

Activity Instructions:

1. Distribute one Beat the Clock Target to each cadet.
2. Have the cadets write their name and date on the target and attach it to the target frame.
3. Have the cadets fire, in relays, following the commands given by the RSO.
4. Have the RSO using the clock, call out one number every 20 second for a total of six numbers.
5. Give the cadets six pellets to fire, one pellet at each hour (number) as it is called.
6. Score the targets awarding one point for each correct number hit on the target.
7. Allow the cadets to review and keep their targets.

The following are prohibited:

- Alterations made to the rifles,
- Supports used as a rest for the rifle or the forearm,
- A spotting scope,
- Use of sights not provided with the cadet air rifle, and
- Coaching.

Note: To make this activity more difficult, shorten the time allowance.

BEAT THE CLOCK TARGET

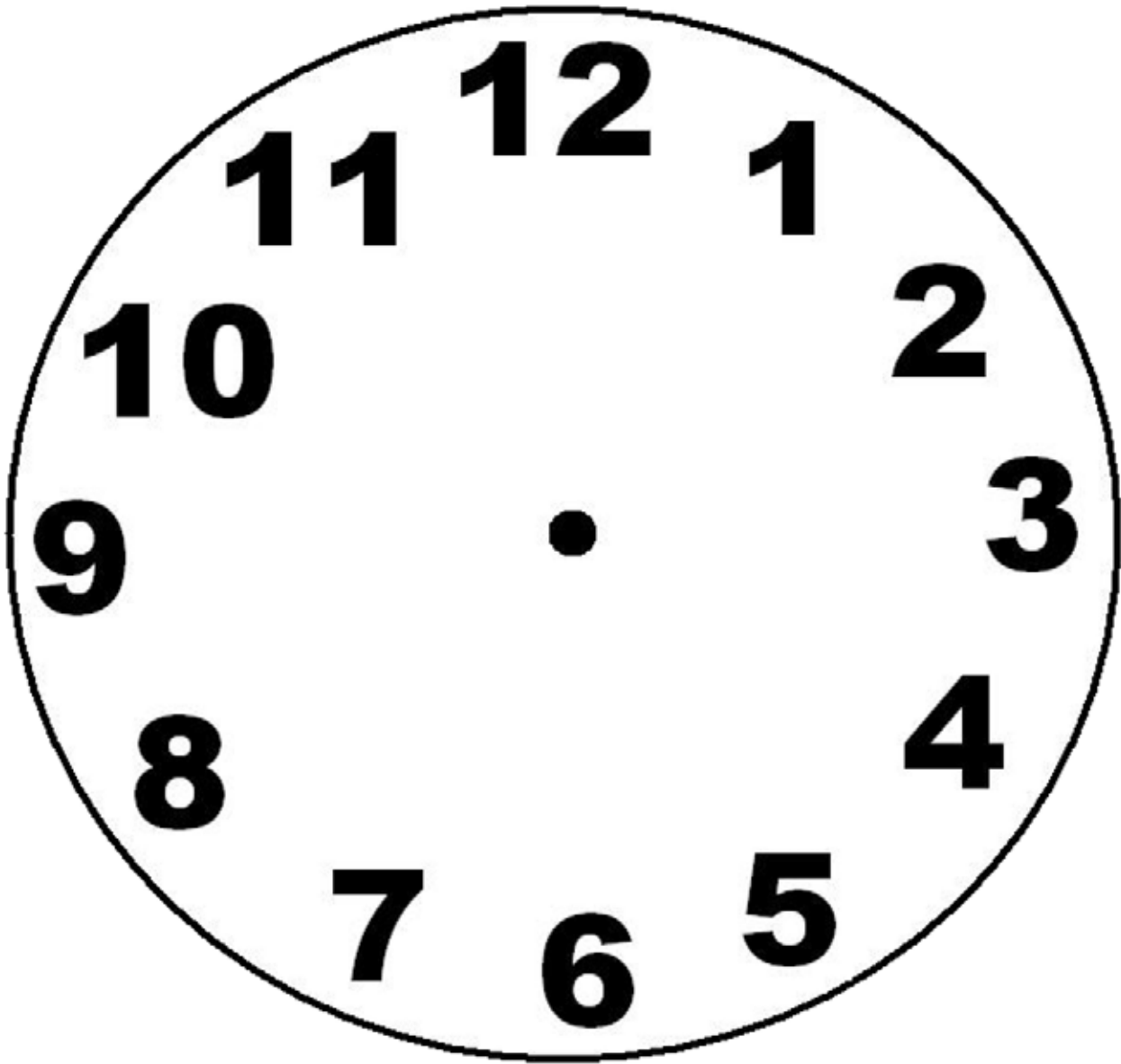

Figure H-1 Clock Target

Note. Created by Director Cadets 3, 2007, Ottawa, ON: Department of National Defence.

Name: _____ Date: _____

COMPETITIVE ACTIVITIES

SQUADRON MARKSMANSHIP COMPETITION

Objective: To provide cadets the opportunity to compete within the squadron.

Scoring: Targets will be scored IAW A-CR-CCP-177/PT-001, *Canadian Cadet Movement: Cadet Marksmanship Program Reference Manual*, to include:

- Each target has a highest possible score of 100 points (10 diagrams worth 10 points each).
- All shot holes are scored using the highest value of the scoring ring that it is broken.
- Shots outside the scoring rings are given a value of zero.
- If more than the one pellet is fired on a target, the shots with the highest value will be discarded until one shot remains on the target. Also, a two-point penalty will be applied to each excess shot.
- If more than one shot is fired at a scoring diagram, only the prescribed number of shots may be fired at the remaining diagrams (eg, if two shots were fired at the first diagram, one diagram on the target would remain blank [free of shots]). If this occurs more than twice, a two-point penalty will be applied to each excess shot.
- This activity may be conducted as individuals or teams of four.

Equipment Required:

Mandatory: CCT2001AR853 CCM Competition Targets (two per cadet).

Optional aids to firing are limited to the following:

- Cadet air rifle sling,
- Marksmanship jacket,
- Shooting glove, and
- Hat.

Activity Instructions:

1. Distribute two CCT2001AR853 CCM Competition Targets to each cadet.
2. Have the cadets write their name and date on each target and attach them to the target frame.
3. Give the cadets 20 scoring pellets to fire, one pellet at each scoring diagram (additional zeroing pellets are permitted).
4. Have the cadets fire, in relays, following the commands given by the RSO.
5. Give the cadets 30 minutes to complete firing.
6. Have the RSO collect the targets, score as described above and record the results.
7. Allow the cadets to review and keep their targets.

The following are prohibited:

- Crossfiring,
- Alterations made to the rifles,
- Supports used as a rest for the rifle or the forearm,
- A spotting scope, and
- Use of sights not provided with the cadet air rifle.

COMPETITIVE ACTIVITIES

LUNAR LAUNCH

Objective: To provide cadets the opportunity to compete within the squadron.

Scoring: The average distance from the earth to the moon is 384 400 km. All targets from marksmanship activities conducted during marksmanship training will be added together to calculate a distance from Earth and achieve a position on the space shuttle crew. The four scoring levels / positions must meet the following standards:

- | | | | |
|----|---------------------|----------------------|---------------------------------------|
| 1. | Mission Commander: | A score of 100 plus: | 384 400 km from earth, lunar landing! |
| 2. | Mission Specialist: | A score of 75 to 99: | 288 300 km from earth. |
| 3. | Chief Engineer: | A score of 50 to 74: | 192 200 km from earth. |
| 4. | Science Officer: | A score of 25 to 49: | 96 100 km from earth, lunar launch! |

Equipment Required:

Mandatory: Scores for all targets used in marksmanship activities during the training year.

Activity Instructions:

1. Add the scores from the targets used by each cadet during the training year.
2. Use the scoring method described above to assign the cadets levels / positions on the space shuttle crew.

Notes:

1. A record must be kept of each cadet's scores from all marksmanship activities.
2. This activity may be conducted over multiple training years.
3. The certificate found at Attachment J may be awarded to cadets who achieve levels / positions in this activity.



This is to certify that

has achieved the position of

in the



Lunar Launch Marksmanship Activity

Date

Range Safety Officer



**COMMON TRAINING
PROFICIENCY LEVEL FOUR
INSTRUCTIONAL GUIDE**



SECTION 2

EO C406.01 – ASSIST THE RANGE SAFETY OFFICER (RSO)

Total Time:

30 min

PREPARATION

PRE-LESSON INSTRUCTIONS

Resources needed for the delivery of this lesson are listed in the lesson specification located in A-CR-CCP-804/PG-001, *Proficiency Level Four Qualification Standard and Plan*, Chapter 4. Specific uses for said resources are identified throughout the instructional guide within the TP for which they are required.

Review the lesson content and become familiar with the material prior to delivering the lesson.

PRE-LESSON ASSIGNMENT

Photocopy, distribute and have each cadet read the Ways to Assist the RSO handout located at Attachment A a minimum of one week prior to delivering the lesson.

APPROACH

A group discussion was chosen for this lesson as it allows the cadets to interact with their peers and share their knowledge, experiences, opinions, and feelings about assisting the RSO. Sharing in the discussion encourages the cadet to examine their own thoughts and feelings and may prompt them to re-examine their previously held ideas. Participating in a group discussion improves the cadets' listening skills and team development.

INTRODUCTION

REVIEW

Nil.

OBJECTIVES

By the end of this lesson the cadet shall be expected to assist the RSO on an air rifle range.

IMPORTANCE

It is important for cadets to have knowledge of how to assist the Range Safety Officer (RSO) on the range. In order to assist the RSO, cadets must know how to set up and dismantle an air rifle range, control pellets, perform the duties of a range sentry, and score targets.

Teaching Point 1**Discuss ways to assist the RSO.**

Time: 25 min

Method: Group Discussion

BACKGROUND KNOWLEDGE

The point of the group discussion is to draw the following information from the group using the tips for answering / facilitating discussion and the suggested questions provided.

SETTING UP AN AIR RIFLE RANGE

Once the required air rifle range equipment has been collected and the cadet air rifles have been inspected, the equipment can be set up. The specific details of an air rifle range layout may vary depending on the type of air rifle range; however, the dimensions and location of the equipment will remain the same. The air rifle range will be set up by:

1. **Post warning signals.** A sentry should be posted at access points if they cannot be permanently blocked (eg, a door to a gymnasium that does not have a lock).
2. **Set up equipment at the backstop.** At one end of the room, the target frames will be set up in front of a wall. Care should be taken to avoid using a wall with windows or other items (eg, light switch, fire alarm, smoke detector) that would be damaged by a stray pellet. If this is unavoidable, a plywood covering should be placed over those items. The front of the target frame must be perpendicular to the floor and aligned with the front of other target frames along a target line. Additional lighting may be required for the target during some competition activities to satisfy competition rules. Lighting will not interfere with the cadets' view of the target frame.
3. **Indicate firing lanes.** Target frames will be centred in a lane at least 1.25 m wide and extend away from the target line toward the firing point a distance of 10 m. 10 m from the target line, another line will be marked on the floor. This is the firing line and no person will move forward of it without permission from the RSO.
4. **Place equipment at the firing point.** Behind the firing line is the firing box, an area at least 1.25 m wide by 2.5 m deep. A firing box will be allocated for each firer. A shooting mat will be placed within the firing box aligned with the firing line (during standing position firing no mat is required). Safety glasses / goggles will be placed on every shooting mat. An area behind the firing box will be allocated for range staff.
5. **Place equipment behind the firing point.** The area behind the firing point contains the table(s) required to set up a pellet distribution point, scoring area or other workspace as required for the specific air rifle marksmanship activity being conducted. The first aid point with stretcher is located in this area and must be clearly identified. The handwashing facility may be located on the range behind the firing point or in a washroom within the building.
6. **Place the cadet air rifle at the firing point.** A cadet air rifle with cadet air rifle safety rod will be the last item placed on the air rifle range. When removing the cadet air rifle from the case, control the muzzle by carrying the cadet air rifle in a vertical position with a cadet air rifle safety rod inserted into the barrel. Once the cadet air rifle is placed on the firing point, the cadet air rifle safety rod may be removed

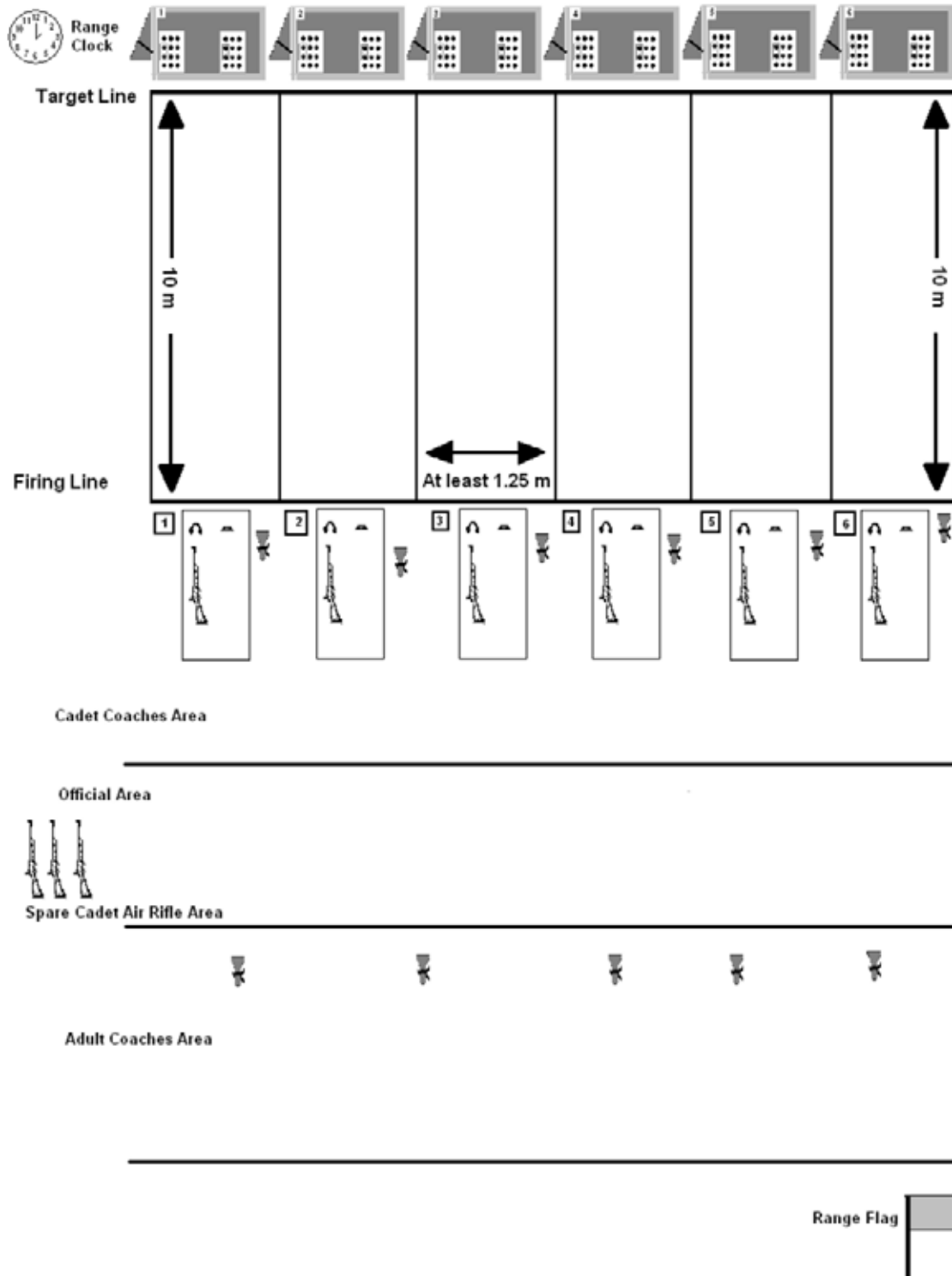

Figure 1 Cadet Air Rifle Range

Note. Created by D Cdt's 3, 2007, Ottawa, ON: Department of National Defence.

DISMANTLING AN AIR RIFLE RANGE

Once the air rifle marksmanship activity has been completed, the air rifle range can be dismantled. The air rifle range will be dismantled by:

1. **Store the cadet air rifle.** After an air rifle marksmanship activity, the cadet air rifle is the first piece of range equipment secured. A cadet air rifle safety rod is inserted into the barrel before the cadet air rifle is moved from the firing point. Cadet air rifles are securely stored at the unit according to current policy guidelines.



For detailed storage requirements for the cadet air rifle refer to NDSI 65, *Storage and Transportation of Rifles for Canadian Rangers, Cadets and Junior Canadian Rangers*.

2. **Store the equipment behind the firing point.** Equipment used behind the firing point is stored next. Equipment must be cleaned (if required) and stored to prevent damage. If the first aid kit has been used, it may require refilling.
3. **Store the equipment at the firing point.** Equipment used at the firing point is stored next. Equipment must be cleaned (if required) and stored to prevent damage. Care should be taken to minimize scratching of safety glasses / goggles. Shooting mats are folded or rolled properly to minimize rips or tears. Spotting scopes are stored in their cases (if applicable).
4. **Clean the backstop area.** Once the firing point equipment has been secured, the target frames are thoroughly emptied of spent pellets. The target holder is cleaned of any material (eg, targets, thumbtacks, staples) and the target frame is folded and stored.
5. **Clean the firing lanes.** Since lead dust in the air is a minor hazard to safety, a method of sweeping / mopping that reduces the amount of dust produced should be used. One set of cleaning gear is used after air rifle marksmanship activities to limit cross-contamination of other areas of the building.
6. **Remove the warning signals.** Once all other air rifle marksmanship equipment has been secured, the range warning signals are removed. This will indicate that the room in which the temporary indoor range was set up is now cleaned and ready for general use.

PELLET CONTROLLER

During an air rifle marksmanship activity, cadets may be appointed to assist the RSO by acting as a pellet controller. The duties of a pellet controller include:

- **Maintain possession of pellets at all times.** Pellets are placed in the possession of the pellet controller. They ensure the pellets are secured at all times by means of direct supervision.
- **Distribute pellets.** Depending on the specific type of air rifle marksmanship activity being conducted, the pellet controller counts pellets into containers that will be placed on the firing point upon the RSO's command.
- **Dispose of pellets.** Once the air rifle marksmanship activity is concluded, the pellet controller ensures that the area around the target frame is swept. The spent pellets are collected into a container for disposal by the RSO.



Since pellets are made of lead, a hazardous material, they must be disposed IAW local standing orders.

- **Record the number of pellets used during the activity.** As the activity proceeds, the pellet controller tracks the number of pellets being used during each relay. Once the activity is complete, the total number of pellets used can be calculated. Any additional pellets given by the RSO / range assistants to cadets during the activity (eg, misfires, deformed pellets) are added to the total. This information is used by the RSO to track the quantity of pellets available at the unit.



The need to record the number of pellets used at a corps / squadron / CSTC may or may not be regionally directed. In the case where no requirement exists, it is still an effective tool for the RSO and a practical leadership opportunity for the cadets acting as pellet controllers.

- **Record the number of pellets used for each rifle.** The Cadet Air Rifle Usage Log shows the RSO when one thousand pellets have been fired by each cadet air rifle. When one thousand pellets have been fired the cadet air rifle requires cleaning. The pellet controller records the total number of pellets used in each cadet air rifle during the air rifle activity.



The Cadet Air Rifle Usage Log was developed as a practical leadership opportunity for cadets to be given added responsibility while they act as a pellet controller.

RANGE SENTRY

A range sentry is responsible, during the course of firing, to restrict entry on to the range and for changing warning signals when instructed to do so by the RSO. They must be able to constantly communicate with the RSO to report any safety concerns.

Restrict Access to the Range During Firing

On most indoor temporary ranges, access points exist and must be secured during the course of firing. By posting a range sentry outside an access point, the RSO can be assured no one can access the range and be struck by pellets. On outdoor ranges, roads leading to the range may need to be blocked and a range sentry posted to control vehicle access. In a situation where the range sentry is unable to directly attract the attention of the RSO, a means of communication such as a hand-held radio may be required.

Control Range Warning Signals

Range sentries are responsible for controlling the range warning signals. At the commencement of an air rifle marksmanship activity, a green flag / light / signal shall be posted to alert people that the range is in use but no live firing is currently in progress. The location of warning signals vary based on the local specifications of the air rifle range being used. Typically, warning signals are posted at the backstop, firing point and on access roads leading to the range.

For indoor ranges, warning signals are posted at entranceways to the room in which the range is set up. On the command of the RSO, the range sentry changes the green warning signal to red. The red signal alerts people that the range is in use and live firing is in progress. The red warning signal is posted from before the course of fire begins until the RSO has cleared the last cadet air rifle of the relay. At this time, on the command of the RSO,

the range sentry changes the warning signal back to green. At the conclusion of the air rifle marksmanship activity, all warning signals are removed to indicate that the range is no longer in use.

Notify the RSO of Safety Concerns Inside / Outside the Range Area

During the conduct of an air rifle marksmanship activity, the range sentry is responsible for bringing safety concerns both on and off the range area to the attention of the RSO. These concerns may include wildlife entering the range or visitors requesting access to the range.

FIRING POINT ASSISTANT

A firing point assistant is appointed by the RSO; usually to a specific number of firing points (eg, firing points 1–4). Their main responsibility is to ensure that the firers are carrying out the RSO's commands safely and correctly.

Supervise Firers Responding to Range Commands

As the RSO gives commands, the firing point assistant observes the firers to ensure they respond correctly. Each cadet should know exactly what to do when given a command on the range. When a cadet does not perform the given command, the firing point assistant will move to the cadet's firing point to ensure they are capable of firing on the range and assist where necessary. If safety is a concern, notify the RSO as soon as possible.

Assist Firers as Necessary

Some cadets may require assistance throughout the firing practice (eg, pumping the cadet air rifle, tightening their sling). The firing point assistant will look for opportunities where assistance is required, and help out the cadets as necessary.

Correct Errors

When errors are made, the firing point assistant will correct them immediately. To correct an error, explain what was done wrong, demonstrate how to perform it correctly (if able to do so) and observe the cadet perform.

Notify the RSO of Safety Concerns

Any safety concerns observed on the range shall be brought to the attention of the RSO immediately.

TARGET SCORER

The target scorer is responsible for scoring targets once they have been fired. Once a target has been scored, the score is recorded directly on the target. In some cases, an RSO may require the scores to be recorded on a spreadsheet or separate piece of paper.



The process for scoring targets is detailed in EO C406.02 (Score Air Rifle Marksmanship Targets).

There are two official targets used for air rifle marksmanship activities: the CCM Air Rifle Grouping Target (CCT2000GRTD) and the CCM Competition Target (CCT2001AR853). There are various targets used in fun and timed air rifle marksmanship activities. These other targets are reproduced locally and can be found attached to the activity's applicable instructional guide.

GROUP DISCUSSION



TIPS FOR ANSWERING / FACILITATING DISCUSSION:

- Establish ground rules for discussion, eg, everyone should listen respectfully; don't interrupt; only one person speaks at a time; no one's ideas should be made fun of; you can disagree with ideas but not with the person; try to understand others as much as you hope they understand you; etc.
- Sit the group in a circle, making sure all cadets can be seen by everyone else.
- Ask questions that will provoke thought; in other words avoid questions with yes or no answers.
- Manage time by ensuring the cadets stay on topic.
- Listen and respond in a way that indicates you have heard and understood the cadet. This can be done by paraphrasing their ideas.
- Give the cadets time to respond to your questions.
- Ensure every cadet has an opportunity to participate. One option is to go around the group and have each cadet answer the question with a short answer. Cadets must also have the option to pass if they wish.
- Additional questions should be prepared ahead of time.

SUGGESTED QUESTIONS:

- Q1. What are some of the ways to assist an RSO?
- Q2. What are the dimensions of a firing lane?
- Q3. What will be the last piece of equipment placed on the air rifle range?
- Q4. What method of cleaning should be used to clean the firing lanes on an indoor temporary air rifle range?
- Q5. What are the five duties of a pellet controller?
- Q6. How must pellets be disposed?
- Q7. What is one benefit of tracking how many pellets were fired during an air rifle activity?
- Q8. What are the responsibilities of a range sentry?
- Q9. Why is it important to restrict access points to the air rifle range?
- Q10. What does a red warning signal indicate?
- Q11. What are the duties of a firing point assistant?
- Q12. What are some occasions on the range in which the firing point assistant can assist the firers?
- Q13. When a cadet is making an error, how should it be corrected?
- Q14. Once a target is scored, where is the value recorded?
- Q15. What are the two official targets used for air rifle marksmanship activities?



Other questions and answers will develop throughout the group discussion. The group discussion should not be limited to only those suggested.



Reinforce those answers given and comments made during the group discussion, ensuring the teaching point has been covered.

CONFIRMATION OF TEACHING POINT 1

The cadets' participation in the group discussion will serve as the confirmation of this TP.

END OF LESSON CONFIRMATION

The cadets' participation in the group discussion will serve as the confirmation of this lesson.

CONCLUSION

HOMEWORK / READING / PRACTICE

Nil.

METHOD OF EVALUATION

Nil.

CLOSING STATEMENT

There will be many opportunities to assist the RSO when completing marksmanship activities. Knowing how to set up and dismantle an air rifle range, enforce safety, control pellets, assist on the firing point and score targets are critical duties that have to be completed whenever completing air rifle marksmanship activities. The ways to assist an RSO produce a variety of leadership opportunities.

INSTRUCTOR NOTES / REMARKS

Cadets will assist the RSO during marksmanship activities, specifically EO M406.01 (Participate in a Recreational Marksmanship Activity) and EO C106.01 (Participate in a Recreational Marksmanship Activity).

REFERENCES

A0-027 A-CR-CCP-177/PT-001 Director Cadets 3. (2005). *Cadet marksmanship program: Reference manual*. Ottawa, ON: Department of National Defence.

A0-041 CATO 14-41 Director Cadets 4. (2009). *Authorized rifle training*. Ottawa, ON: Department of National Defence.

WAYS TO ASSIST THE RSO

SET UP AN AIR RIFLE RANGE

Once the required air rifle range equipment has been collected and the cadet air rifles have been inspected, the equipment can be set up. The specific details of an air rifle range layout may vary depending on the type of air rifle range; however, the dimensions and location of the equipment will remain the same. The air rifle range will be set up by:

1. **Post warning signals.** A sentry should be posted at access points if they cannot be permanently blocked (eg, a door to a gymnasium that does not have a lock).
2. **Set up equipment at the backstop.** At one end of the room, the target frames will be set up in front of a wall. Care should be taken to avoid using a wall with windows or other items (eg, light switch, fire alarm, smoke detector) that would be damaged by a stray pellet. If this is unavoidable, a plywood covering should be placed over those items. The front of the target frame must be perpendicular to the floor and aligned with the front of other target frames along a target line. Additional lighting may be required for the target during some competition activities to satisfy competition rules. Lighting will not interfere with the cadets' view of the target frame.
3. **Indicate firing lanes.** Target frames will be centred in a lane at least 1.25 m wide and extend away from the target line toward the firing point a distance of 10 m. 10 m from the target line, another line will be marked on the floor. This is the firing line and no person will move forward of it without permission from the RSO.
4. **Place equipment at the firing point.** Behind the firing line is the firing box, an area at least 1.25 m wide by 2.5 m deep. A firing box will be allocated for each firer. A shooting mat will be placed within the firing box aligned with the firing line (during standing position firing no mat is required). Safety glasses / goggles will be placed on every shooting mat. An area behind the firing box will be allocated for range staff.
5. **Place equipment behind the firing point.** The area behind the firing point contains the table(s) required to set up a pellet distribution point, scoring area or other workspace as required for the specific air rifle marksmanship activity being conducted. The first aid point with stretcher is located in this area and must be clearly identified. The handwashing facility may be located on the range behind the firing point or in a washroom within the building.
6. **Place the cadet air rifle at the firing point.** A cadet air rifle with cadet air rifle safety rod will be the last item placed on the air rifle range. When removing the cadet air rifle from the case, control the muzzle by carrying the cadet air rifle in a vertical position with a cadet air rifle safety rod inserted into the barrel. Once the cadet air rifle is placed on the firing point, the cadet air rifle safety rod may be removed.

DISMANTLE AN AIR RIFLE RANGE

Once the air rifle marksmanship activity has been completed, the air rifle range can be dismantled. The air rifle range will be dismantled by:

1. **Store the cadet air rifle.** After an air rifle marksmanship activity, the cadet air rifle is the first piece of range equipment secured. A cadet air rifle safety rod is inserted into the barrel before the cadet air rifle is moved from the firing point. Cadet air rifles are securely stored at the unit according to current policy guidelines.
2. **Store the equipment behind the firing point.** Equipment used behind the firing point is stored next. Equipment must be cleaned (if required) and stored to prevent damage. If the first aid kit has been used, it may require refilling.

3. **Store the equipment at the firing point.** Equipment used at the firing point is stored next. Equipment must be cleaned (if required) and stored to prevent damage. Care should be taken to minimize scratching of safety glasses / goggles. Shooting mats are folded or rolled properly to minimize rips or tears. Spotting scopes are stored in their cases (if applicable).
4. **Clean the backstop area.** Once the firing point equipment has been secured, the target frames are thoroughly emptied of spent pellets. The target holder is cleaned of any material (eg, targets, thumbtacks, staples) and the target frame is folded and stored.
5. **Clean the firing lanes.** Since lead dust in the air is a minor hazard to safety, a method of sweeping / mopping that reduces the amount of dust produced should be used. One set of cleaning gear is used after air rifle marksmanship activities to limit cross-contamination of other areas of the building.
6. **Remove the warning signals.** Once all other air rifle marksmanship equipment has been secured, the range warning signals are removed. This will indicate that the room in which the temporary indoor range was set up is now cleaned and ready for general use.

PELLET CONTROLLER

During an air rifle marksmanship activity, cadets may be appointed to assist the RSO by acting as a pellet controller. The duties of a pellet controller include:

- **Maintain possession of pellets at all times.** Pellets are placed in the possession of the pellet controller. They ensure the pellets are secured at all times by means of direct supervision.
- **Distribute pellets.** Depending on the specific type of air rifle marksmanship activity being conducted, the pellet controller counts pellets into containers that will be placed on the firing point upon the RSO's command.
- **Dispose of pellets.** Once the air rifle marksmanship activity is concluded, the pellet controller ensures that the area around the target frame is swept. The spent pellets are collected into a container for disposal by the RSO.
- **Record the number of pellets used during the activity.** As the activity proceeds, the pellet controller tracks the number of pellets being used during each relay. Once the activity is complete, the total number of pellets used can be calculated. Any additional pellets given by the RSO / range assistants to cadets during the activity (eg, misfires, deformed pellets) are added to the total. This information is used by the RSO to track the quantity of pellets available at the unit.
- **Record the number of pellets used for each rifle.** The Cadet Air Rifle Usage Log shows the RSO when one thousand pellets have been fired by each cadet air rifle. When one thousand pellets have been fired the cadet air rifle requires cleaning. The pellet controller records the total number of pellets used in each cadet air rifle during the air rifle activity.

RANGE SENTRY

A range sentry is responsible, during the course of firing, to restrict entry on to the range and for changing warning signals when instructed to do so by the RSO. They must be able to constantly communicate with the RSO to report any safety concerns.

Restrict Access to the Range During Firing

On most indoor temporary ranges, access points exist and must be secured during the course of firing. By posting a range sentry outside an access point, the RSO can be assured no one can access the range and be struck by pellets. On outdoor ranges, roads leading to the range may need to be blocked and a range sentry

posted to control vehicle access. In a situation where the range sentry is unable to directly attract the attention of the RSO, a means of communication such as a hand-held radio may be required.

Control Range Warning Signals

Range sentries are responsible for controlling the range warning signals. At the commencement of an air rifle marksmanship activity, a green flag / light / signal shall be posted to alert people that the range is in use but no live firing is currently in progress. The location of warning signals vary based on the local specifications of the air rifle range being used. Typically, warning signals are posted at the backstop, firing point and on access roads leading to the range.

For indoor ranges, warning signals are posted at entranceways to the room in which the range is set up. On the command of the RSO, the range sentry changes the green warning signal to red. The red signal alerts people that the range is in use and live firing is in progress. The red warning signal is posted from before the course of fire begins until the RSO has cleared the last cadet air rifle of the relay. At this time, on the command of the RSO, the range sentry changes the warning signal back to green. At the conclusion of the air rifle marksmanship activity, all warning signals are removed to indicate that the range is no longer in use.

Notify the RSO of Safety Concerns Inside / Outside the Range Area

During the conduct of an air rifle marksmanship activity, the range sentry is responsible for bringing safety concerns both on and off the range area to the attention of the RSO. These concerns may include wildlife entering the range or visitors requesting access to the range.

FIRING POINT ASSISTANT

A firing point assistant is appointed by the RSO; usually to a specific number of firing points (eg, firing points 1–4). Their main responsibility is to ensure that the firers are carrying out the RSO's commands safely and correctly.

Supervise Firers Responding to Range Commands

As the RSO gives commands, the firing point assistant observes the firers to ensure they respond correctly. Each cadet should know exactly what to do when given a command on the range. When a cadet does not perform the given command, the firing point assistant will move to the cadets firing point to ensure they are capable of firing on the range and assist where necessary. If safety is a concern, notify the RSO as soon as possible.

Assist Firers as Necessary

Some cadets may require assistance throughout the firing practice (eg, pumping the cadet air rifle, tightening their sling). The firing point assistant will look for opportunities where assistance is required, and help out the cadets as necessary.

Correct Errors

When errors are made, the firing point assistant will correct them immediately. To correct an error, explain what was done wrong, demonstrate how to perform it correctly (if able to do so) and observe the cadet perform.

Notify the RSO of Safety Concerns

Any safety concerns observed on the range shall be brought to the attention of the RSO immediately.

TARGET SCORER

The target scorer is responsible for scoring targets once they have been fired. Once a target has been scored, the score is recorded directly on the target. In some cases, an RSO may require the scores to be recorded on a spreadsheet or separate piece of paper.

There are two official targets used for air rifle marksmanship activities: the CCM Air Rifle Grouping Target (CCT2000GRTD) and the CCM Competition Target (CCT2001AR853). There are various targets used in fun and timed air rifle marksmanship activities. These other targets are reproduced locally and can be found attached to the activity's applicable instructional guide.



**COMMON TRAINING
PROFICIENCY LEVEL FOUR
INSTRUCTIONAL GUIDE**



SECTION 3

EO C406.02 – SCORE AIR RIFLE MARKSMANSHIP TARGETS

Total Time:

30 min

PREPARATION

PRE-LESSON INSTRUCTIONS

Resources needed for the delivery of this lesson are listed in the lesson specification located in A-CR-CCP-804/PG-001, *Proficiency Level Four Qualification Standard and Plan*, Chapter 4. Specific uses for said resources are identified throughout the instructional guide within the TP for which they are required.

Review the lesson content and become familiar with the material prior to delivering the lesson.

Photocopy the Sample Grouping Target handout located at Attachment A for each cadet.

Photocopy the Sample Competition Target handout located at Attachment C for each cadet.

Prepare slides of the Air Rifle Grouping Template and Scoring Template found at Attachments B and D for each cadet.

PRE-LESSON ASSIGNMENT

Nil.

APPROACH

An interactive lecture was chosen for TP 1 to orient the cadets to the targets used during air rifle marksmanship activities and to generate interest in the subject.

A demonstration and performance was chosen for TPs 2 and 3 as it allows the instructor to explain and demonstrate scoring grouping and competition targets while providing an opportunity for the cadets to practice under supervision.

INTRODUCTION

REVIEW

Nil.

OBJECTIVES

By the end of this lesson the cadet shall be expected to score the CCM Air Rifle Grouping Target and the CCM Competition Target.

IMPORTANCE

It is important for cadets to score air rifle marksmanship targets as it provides a skill that will be used when they assist a Range Safety Officer (RSO). Being able to determine the score on a target will allow the cadet to monitor their progress as they improve in applying the principles of marksmanship.

Teaching Point 1**Describe air rifle marksmanship targets.**

Time: 5 min

Method: Interactive Lecture

AIR RIFLE MARKSMANSHIP TARGETS

There are two official targets used for air rifle marksmanship activities: the CCM Air Rifle Grouping Target (CCT2000GRTD) and the CCM Competition Target (CCT2001AR853). There are various targets used in fun and timed air rifle marksmanship activities. These other targets are reproduced locally and can be found attached to the activity's applicable instructional guide.

CCM Air Rifle Grouping Target

The CCM Air Rifle Grouping Target is used during classification air rifle marksmanship activities. The target consists of two diagrams. Each diagram is a shaded black circle that is 3 cm in diameter. The diagram itself is provided on the target to give the marksman an aiming mark and thus any grouping fired at each diagram does not necessarily need to be contained on the black portion of the target.

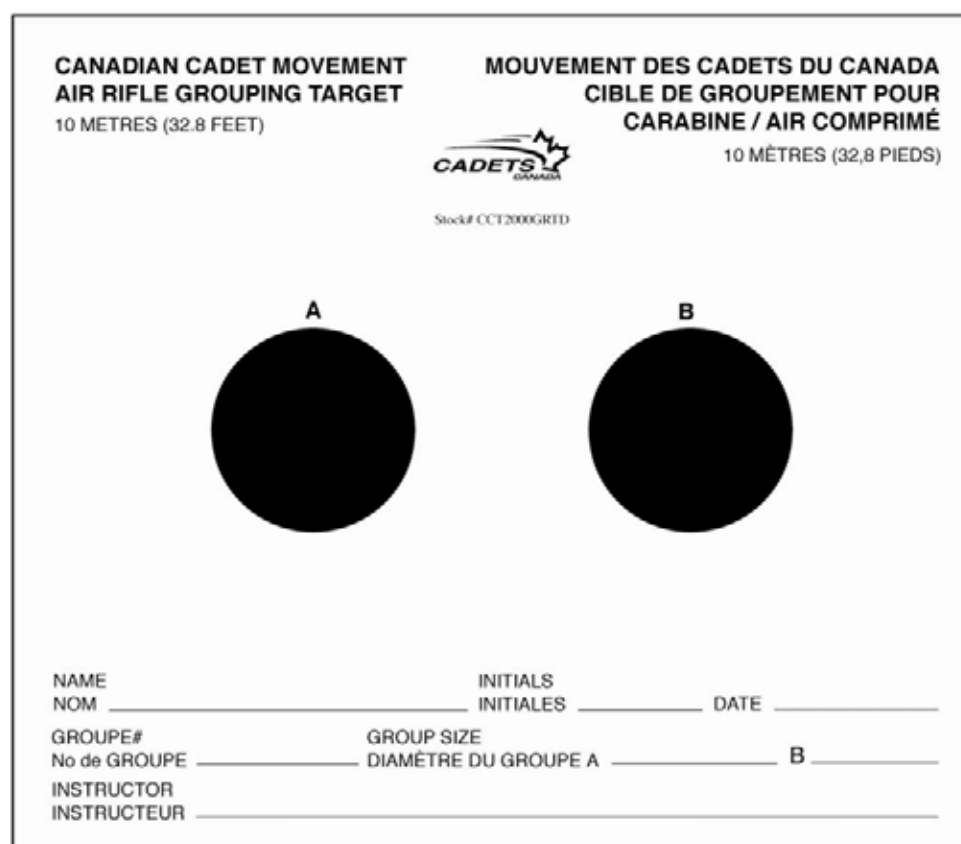

Figure 1 The CCM Air Rifle Grouping Target (CCT2000GRTD)

Note. Created by Director Cadets 4, 2000, Ottawa, ON: Department of National Defence.

CCM Competition Target

The CCM Competition Target, also called an application target, is the official target used in the CCM Marksmanship Championship Series. This target is used only with the cadet air rifle at a distance of 10 m (32.8 ft). The target contains 10 scoring diagrams and two sighting diagrams. Each scoring diagram consists of a 4.5-mm circle (the inner 3 cm of the scoring diagram is shaded black as an aiming mark) broken into

10 concentric scoring rings, scored from ten (the bull's eye) to one (the outer most ring). As there are 10 scoring diagrams, the highest possible score (HPS) is 100. The sighting diagrams, identical to the scoring diagrams and labelled A and B, are used by the firer to confirm zeroing the cadet air rifle during the competition relay.

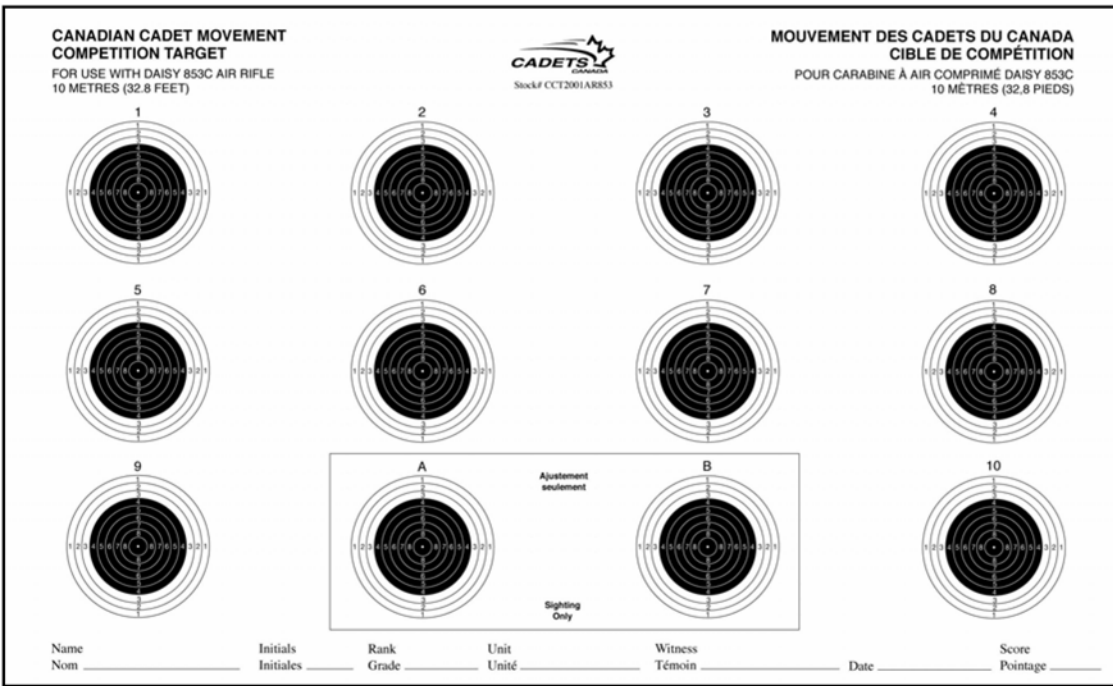



Figure 2 The CCM Competition Target (CCT2001AR853)

Note. Created by Director Cadets 4, 2001, Ottawa, ON: Department of National Defence.

Non-Standard Targets

Non-standard targets are used during fun and timed air rifle marksmanship activities. Non-standard targets are designed to give cadets a break from firing on the two official targets and allow for the development of activities that provide a different style marksmanship experience. Some examples of non-standard targets include the turkey shoot target, beat the clock targets, balloon targets and chase the dot targets. Other non-standard targets may be developed for use during fun and timed air rifle marksmanship activities by the activity leader as required.



Examples of non-standard targets used during fun and timed air rifle marksmanship activities can be found as attachments to EO M406.01 (Participate in a Recreational Marksmanship Activity). These targets are reproduced locally.

CONFIRMATION OF TEACHING POINT 1

QUESTIONS:

- Q1. How many scoring diagrams are there on the CCM Competition Target?
- Q2. What is the HPS on the CCM Competition Target?
- Q3. What are some types of targets used during fun and timed air rifle marksmanship activities?

ANTICIPATED ANSWERS:

- A1. There are 10 scoring diagrams on the CCM Competition Target.
- A2. The HPS on the CCM Competition Target is 100.
- A3. Some targets used during timed air rifle marksmanship targets are beat the clock, speed grid and chase the dots.

Teaching Point 2**Explain, demonstrate and have the cadets score the CCM Air Rifle Grouping Target.**

Time: 10 min

Method: Demonstration and Performance



For this TP it is recommended that the instructor explain and demonstrate each step required to complete the skill then monitor the cadets as they imitate each step.

Note: Assistant instructors may be employed to monitor the cadets' performance.



Provide each cadet with the Sample Grouping Target handouts located at Attachment A and an Air Rifle Grouping Template located at Attachment B.

Air Rifle Grouping Template. The Air Rifle Grouping Template is a series of grouping circles engraved or printed on transparent material. It is used to confirm the diameter of a grouping fired during familiarization or classification firing. The Air Rifle Grouping Template consists of a series of grouping circle outlines, with diameters from 1–6 cm inclusive. It is very important to correctly and consistently measure grouping targets with the grouping template.

SCORING THE CCM AIR RIFLE GROUPING TARGET

Score the CCM Air Rifle Grouping Target using the following procedure:

1. **Determine there are five shots in the grouping.** Before scoring any grouping, the number of shots on the target is determined. If a cadet has not hit the target at least five times for each grouping the score will not count. It is difficult at times to determine when several pellet holes overlap. Observe the outline of the hole for the distinct outline of an arc of a clean pellet hole. This indicates the number of pellets that may have caused the larger hole. The skill level of cadets is also a good indication of how many shots are in a grouping. If a cadet is shooting a larger grouping size, the possibility for two pellets fired exactly through one hole is slim.



Each diagram on the Sample Grouping Target handout contains five shots.

2. **Align the Air Rifle Grouping Template over the five-shot grouping so that all shots are within a scoring ring.** Once the grouping has been confirmed as being made up of five shots, the Air Rifle

Grouping Template is placed over the target. The Air Rifle Grouping Template should be aligned so that all the shots fit easily within a grouping circle without touching.



A grouping size of 4 cm will be large enough to serve as a starting point for each diagram on the Sample Grouping Target handout.

3. **Determine if the grouping will fit within the next smallest ring without touching the scoring ring.** Choose the next smallest grouping circle and determine if the group fits within it. The entire group must fit within the grouping circle without touching the inside edge.
4. **Repeat as required until the grouping will not fit within the next smallest scoring ring without touching the scoring ring.**



The correct grouping size for each diagram from the Sample Grouping Target handout is:

- Target 1, Diagram A—3.5 cm,
- Target 1, Diagram B—2.7 cm,
- Target 2, Diagram A—1.8 cm, and
- Target 2, Diagram B—2.5 cm.

5. **Record the grouping size on the target.** The grouping size recorded on the target is the corresponding grouping circle diameter.
6. **Determine the classification category.** Once two groupings have been scored on one grouping target, a determination is made as to the classification category obtained. There are four categories of marksmanship classification.
 - **Marksman:** Each grouping must be within a circle of 3 cm in diameter.
 - **First Class Marksman:** Each grouping must be with a circle of 2.5 cm in diameter.
 - **Expert Marksman:** Each grouping must be within a circle of 2 cm in diameter.
 - **Distinguished Marksman:** Each grouping must be within a circle of 1.5 cm in diameter.

Each marksmanship classification category has a corresponding badge that may be worn on the uniform. The marksmanship classification does not expire and any improvement in the classification category during subsequent classification air rifle activities is reflected with the awarding of the higher category.



From the Sample Grouping Target handout, Target 1 does not meet the requirements for a marksmanship classification category. Target 2 meets the requirements for a First Class Marksman classification category.



Refer to Annex A of CATO 14-43, *Marksmanship Program*, for detailed instructions about the marksmanship classification program.

CONFIRMATION OF TEACHING POINT 2

The cadets' scoring of the Sample Grouping Target handout will serve as the confirmation of this TP.

Teaching Point 3

Explain, demonstrate and have the cadets score the CCM Competition Target.

Time: 10 min

Method: Demonstration and Performance



For this TP it is recommended that the instructor explain and demonstrate each step required to complete the skill then monitor the cadets as they imitate each step.

Note: Assistant instructors may be employed to monitor the cadets' performance.



Divide the cadets into groups based on the number of scoring magnifiers and scoring plugs available. Distribute a Sample Competition Target handout located at Attachment C to each cadet. Distribute a scoring magnifier, scoring plug and Scoring Template found at Attachment D to each group.

SCORING THE CCM COMPETITION TARGET

Score the CCM Competition Target using the following procedure:

1. **Determine the score on each diagram.** Determine the score for each diagram using one or more of the following methods:
 - a. **Determine the value by inspecting with the naked eye.** In most cases the scoring ring that has been broken is easily identifiable. The scoring diagrams on the competition target that can be scored in this manner are scored first as they can be completed in less time.
 - b. **Determine the value using the .177-scoring magnifier.** If the pellet hole has occurred close to the edge of a scoring ring, it is necessary to use the scoring magnifier to enlarge the view and make a determination of value. Look through the magnifying lens and align the scoring magnifier over the pellet hole. If the pellet hole has broken or touched the higher scoring ring, award that value. If even a small gap exists between the pellet hole and the scoring ring the lower value must be awarded.
2. **Calculate penalties.** When scoring a target there are two penalties the scorer can determine and calculate. If a penalty is imposed, the rule number and penalty amount is noted next to the applicable diagram. The following rules are excerpts from the Canadian Cadet Movement Marksmanship Championship Series (CCMMCS).

22.3.4.1 If a Competitor fires more than the prescribed number of shots on the scoring area in a twenty (20) shot string, the shot(s) with the highest value will be discarded until the correct number of shots remain. In addition, a two (2) point Penalty will be deducted for each excess shot.

22.3.4.2 If a Competitor fires more than the prescribed number of shots on a scoring diagram, the Competitor must fire a like number of fewer shots on a subsequent scoring diagram in the same twenty (20) shot string. The Competitor will not be penalized for the first two (2) such occurrences in a Competition, but will be penalized two (2) points for each succeeding occurrence.

Figure 3 Scoring Penalties

Note. From Canadian Cadet Movement: Cadet Marksmanship Program Reference Manual (p. 4-4-31), by Director Cadets 3, 2005, Ottawa, ON: Department of National Defence.

3. **Record the score on the target.** Once the diagrams are given values and penalties are calculated, the score is totalled and recorded on the target. It is important to ensure the addition of values is accurate since during a competition protests may be filed due to inaccurate calculations.

CONFIRMATION OF TEACHING POINT 3

The cadets' scoring of the Sample Competition Target handout will serve as the confirmation of this TP.

END OF LESSON CONFIRMATION

QUESTIONS:

- Q1. What are the three types of targets used during air rifle marksmanship activities?
- Q2. What size must each grouping be to award a Distinguished Marksman classification category?
- Q3. When scoring targets, how is it determined when to score the higher ring value and when to score the lower ring value?

ANTICIPATED ANSWERS:

- A1. The three types of targets are the CCM Grouping Target, CCM Competition Target and non-standard targets.
- A2. Each grouping must be within a circle of 1.5 cm in diameter.
- A3. If the pellet hole has broken or touched the higher scoring ring, award that value. If even a small gap exists between the pellet hole and the scoring ring the lower value must be awarded.

CONCLUSION

HOMEWORK / READING / PRACTICE

Nil.

METHOD OF EVALUATION

Nil.

CLOSING STATEMENT

You must be able to score air rifle marksmanship targets to perform your duties when assisting the RSO. Being able to score air rifle marksmanship targets will also allow you to assess your own performance and the performance of others.

INSTRUCTOR NOTES / REMARKS

Nil.

REFERENCES

A0-027 A-CR-CCP-177/PT-001 Director Cadets 3. (2005). *Canadian Cadet Movement: Cadet marksmanship program reference manual*. Ottawa, ON: Department of National Defence.

THIS PAGE INTENTIONALLY LEFT BLANK

SAMPLE GROUPING TARGET

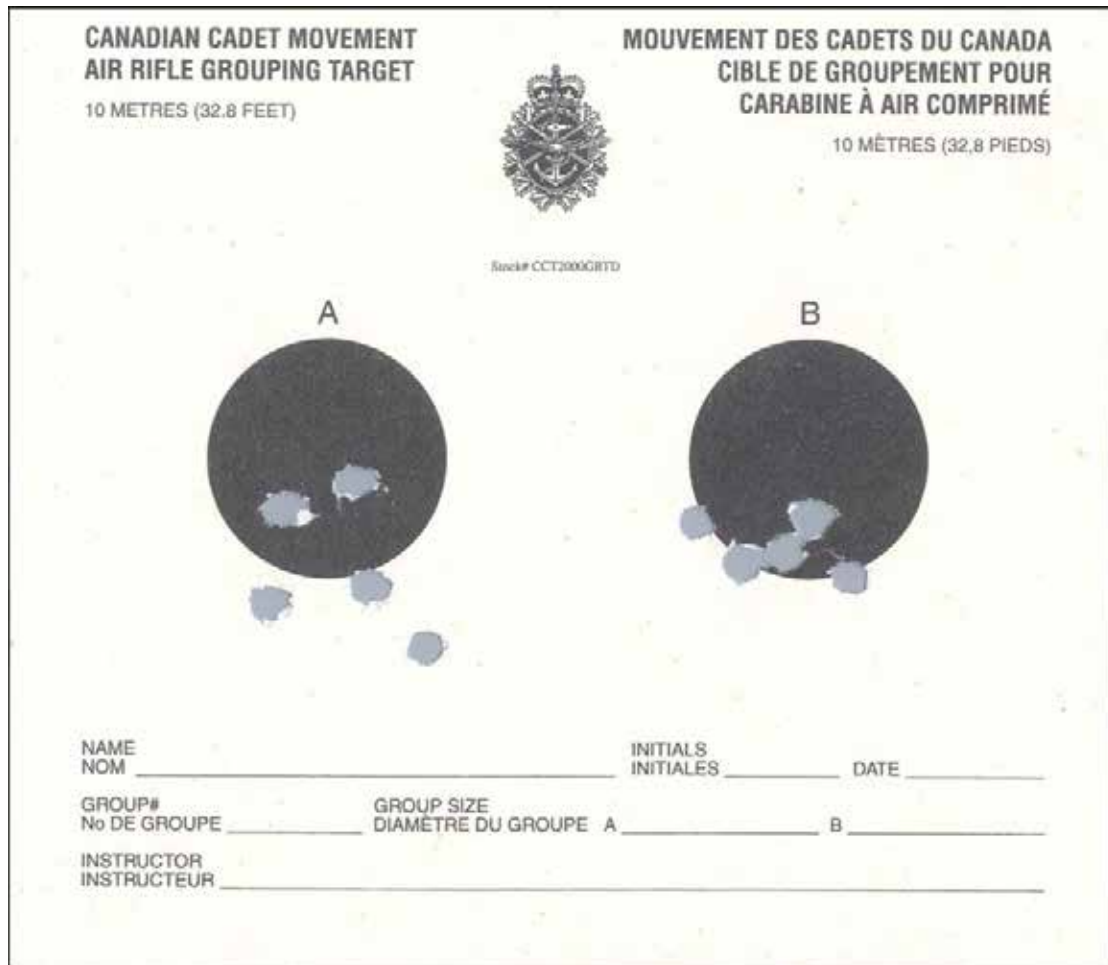

Figure A-1 Target 1

Note. Created by Director Cadets 3, 2009, Ottawa, ON: Department of National Defence.

SAMPLE GROUPING TARGET

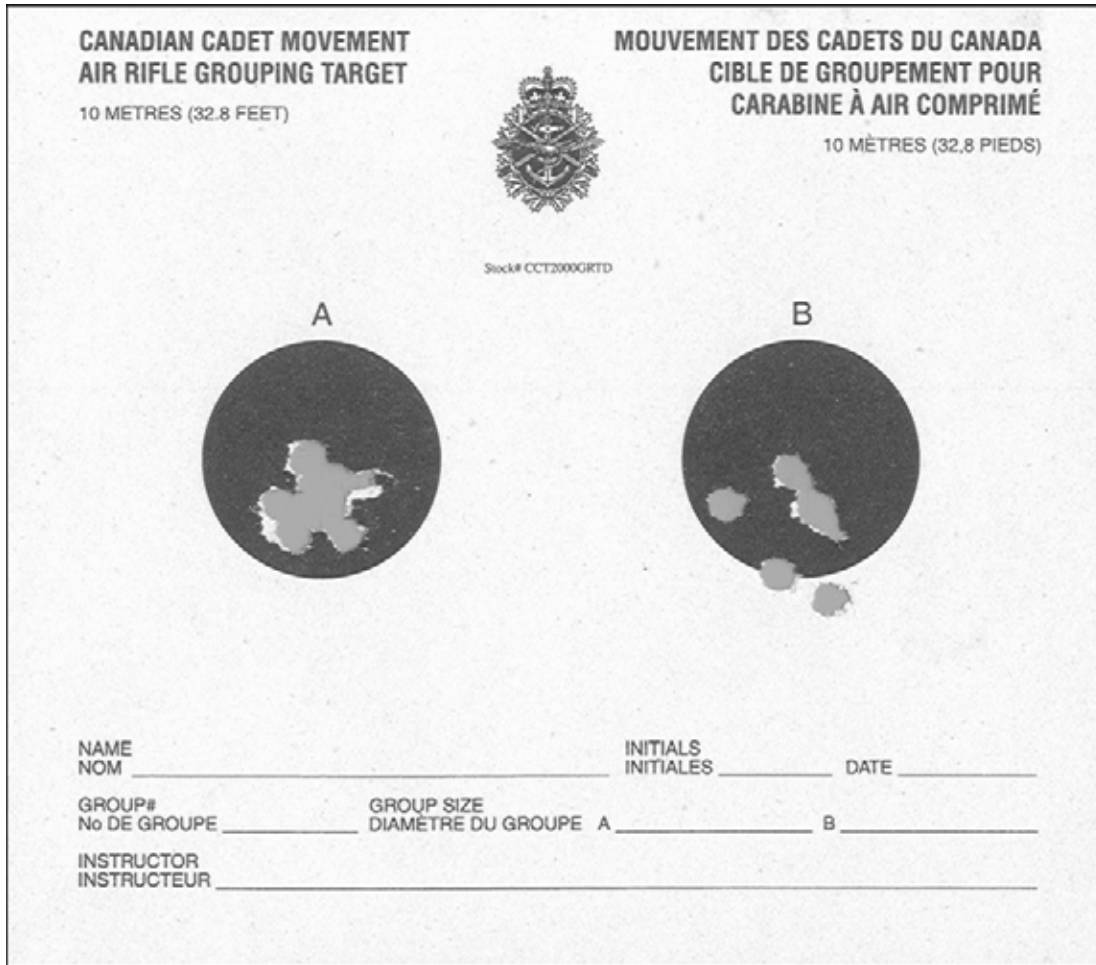

Figure A-2 Target 2

Note. Created by Director Cadets 3, 2009, Ottawa, ON: Department of National Defence.

AIR RIFLE GROUPING TEMPLATE

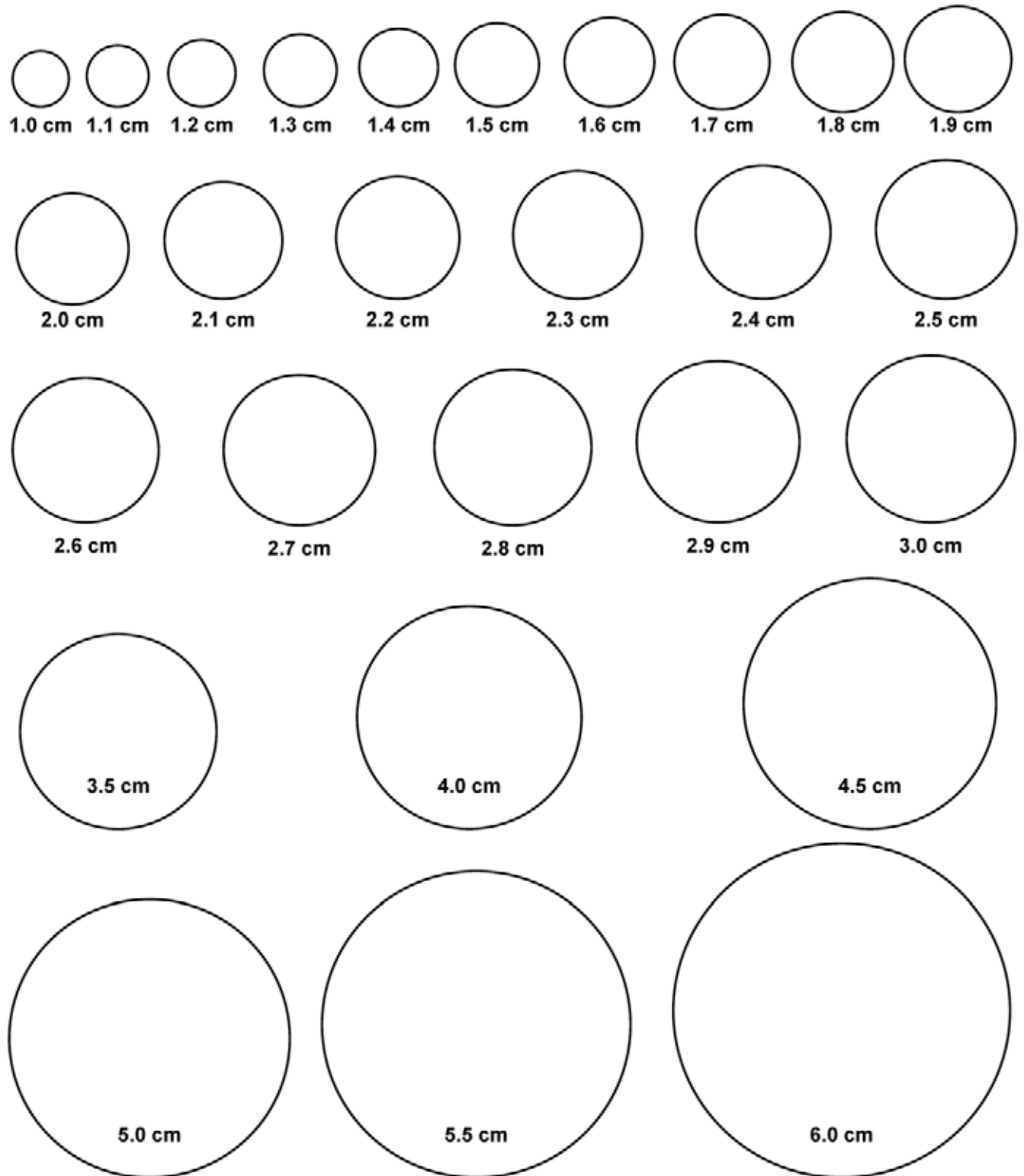

Figure B-1 Air Rifle Grouping Template

Note. Created by Director Cadets 3, 2009, Ottawa, ON: Department of National Defence.

THIS PAGE INTENTIONALLY LEFT BLANK

SAMPLE COMPETITION TARGET

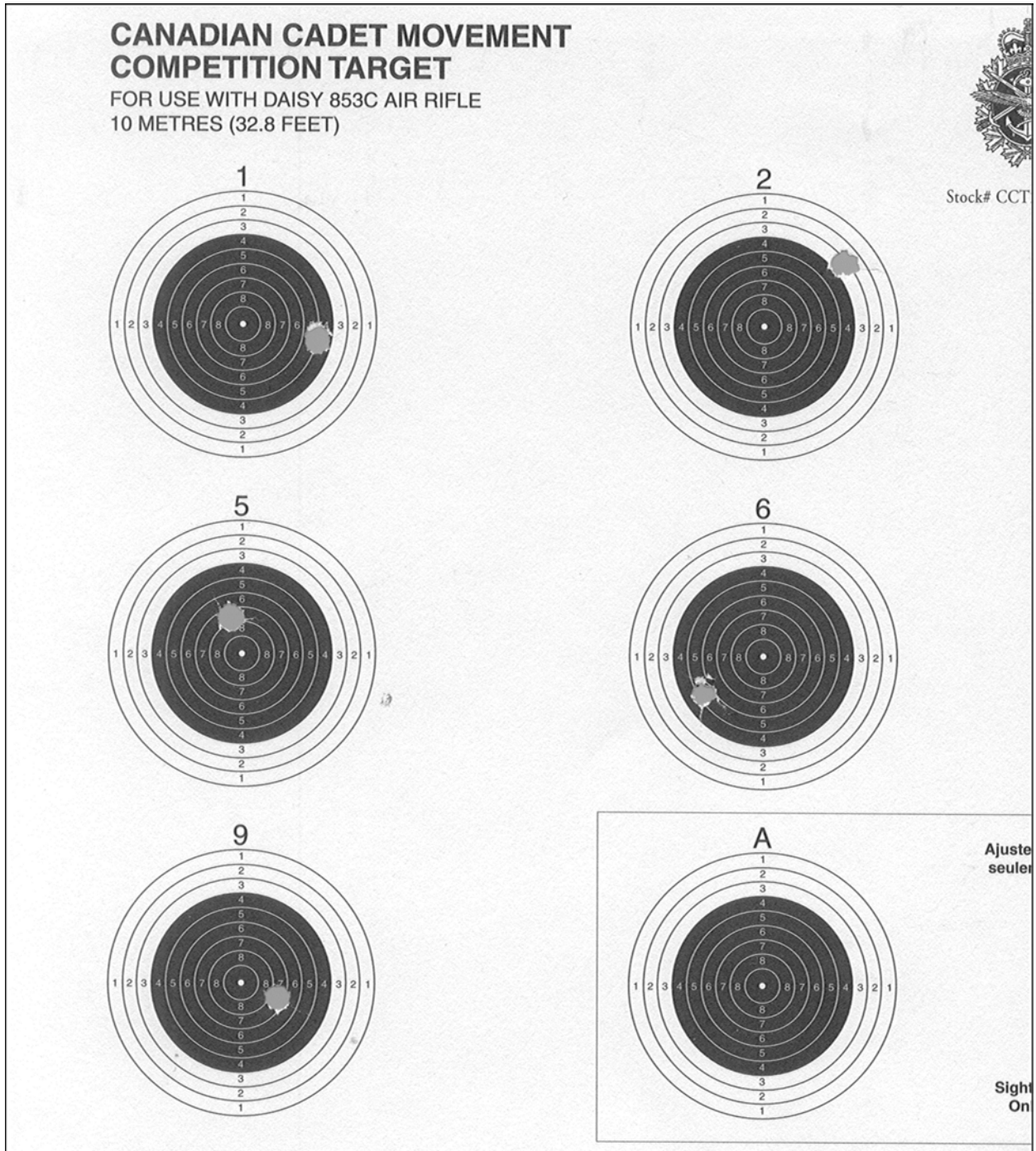

Figure C-1 Target 1 (Left Half)

Note. Created by Director Cadets 3, 2009, Ottawa, ON: Department of National Defence.

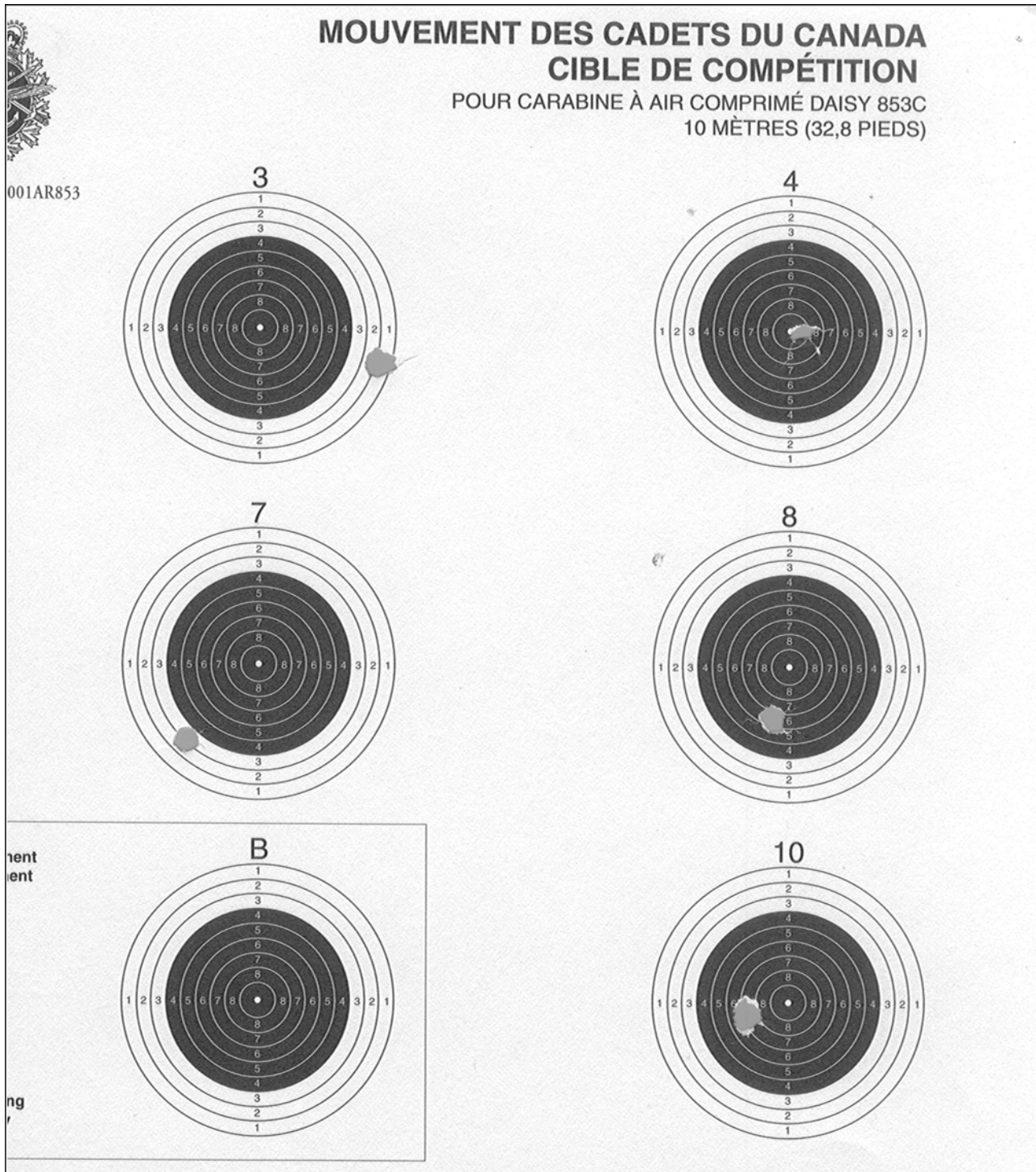

Figure C-2 Target 1 (Right Half)

Note. Created by Director Cadets 3, 2009, Ottawa, ON: Department of National Defence.

SCORING TEMPLATE



Figure D-1 Scoring Template

Note. Created by Director Cadets 3, 2009, Ottawa, ON: Department of National Defence.

THIS PAGE INTENTIONALLY LEFT BLANK



**ROYAL CANADIAN AIR CADETS
PROFICIENCY LEVEL FOUR
INSTRUCTIONAL GUIDE**



SECTION 1

EO M407.01 – DISCUSS PROFICIENCY LEVEL FOUR TRAINING OPPORTUNITIES

Total Time:	30 min
-------------	--------

PREPARATION

PRE-LESSON INSTRUCTIONS

Resources needed for the delivery of this lesson are listed in the lesson specification located in A-CR-CCP-804/PG-001, *Proficiency Level Four Qualification Standard and Plan*, Chapter 4. Specific uses for said resources are identified throughout the instructional guide within the TP for which they are required.

Review the lesson content and become familiar with the material prior to delivering the lesson.

Photocopy Attachment A for each cadet.

Prepare a handout or slide of the year's training schedule.

PRE-LESSON ASSIGNMENT

Nil.

APPROACH

An in-class activity was chosen for TP 1 as it is an interactive way to provoke thought and stimulate interest among the cadets.

An interactive lecture was chosen for TP 2 to orient the cadets to and generate interest in Proficiency Level Four complementary training opportunities.

A group discussion was chosen for TP 3 as it allows the cadets to interact with their peers and share their knowledge, experiences, opinions, and feelings about leadership appointments at the squadron.

INTRODUCTION

REVIEW

Nil.

OBJECTIVES

By the end of this lesson the cadet shall have discuss Proficiency Level Four training opportunities.

IMPORTANCE

It is important for cadets to know what training will be conducted during Proficiency Level Four to give them an overview of what the training year will entail. This lesson will prepare the cadets for the training year and help generate interest in the topics.

Teaching Point 1

Conduct an in-class activity to identify Proficiency Level Four mandatory training opportunities.

Time: 10 min

Method: In-Class Activity

OVERVIEW

The training program is broken into Performance Objectives (POs), which are the overall subjects, and Enabling Objectives (EOs), which are the topics within each PO. Training is conducted as mandatory and complementary components.

	Distribute a handout of Attachment A to each cadet.
---	---

MANDATORY TRAINING

Mandatory training encompasses the EOs that all squadrons must complete throughout the training year.

ACTIVITY

OBJECTIVE

The objective of this activity is to have the cadets participate in a gallery walk of information for each PO in order to identify Proficiency Level Four mandatory training opportunities.

RESOURCES

Resources will be IAW each PO as listed below.

ACTIVITY LAYOUT

The classroom will be set up with a station for each PO with a basic description of the PO, information, pictures, videos, and other training aids that will illustrate what the cadet will learn in each PO.

PO 402–Community Service

Community service provides the cadets an opportunity to perform community service. The community service should provide a direct benefit to the community and promote good citizenship.

	Examples of information / training aids that could be set up at this station include: <ul style="list-style-type: none">• pictures from recent community service activities in which the squadron has participated, and• video or pictures from Remembrance Day ceremonies or other ceremonial parades.
---	--

PO 403–Leadership

Leadership provides the cadets an opportunity to describe needs and expectations of team members, select an influence behaviour within the empowering leadership style, describe how to motivate cadets, provide feedback to team members, participate in a mentoring relationship and act as a team leader during a leadership appointment.



Examples of information / training aids that could be set up at this station include:

- motivational pictures of famous Canadian leaders, and
- pictures of cadets from the squadron participating in leadership activities.

PO 404–Personal Fitness and Healthy Living

Personal fitness and healthy living provides the cadets an opportunity to participate in the cadet fitness assessment, update personal activity plan and evaluate personal activity plan.



Examples of information / training aids that could be set up at this station include:

- a CD / cassette player with the audio recording of the 20-m Shuttle Run Test beeps, and
- copies of the Cadet Fitness Assessment Scoresheet.

PO 405–Recreational Sports

Recreational sports provide the cadets the opportunity to participate in organized recreational team sports. This is important as physical fitness is one of the aims of the cadet program.



Examples of information / training aids that could be set up at this station include:

- soccer ball,
- volleyball,
- floor hockey ball,
- hockey sticks,
- Frisbees, and
- pictures of cadets at the squadron participating in recreational sports.

PO 406–Air Rifle Marksmanship

Air rifle marksmanship provides the cadets an opportunity to participate in a recreational air rifle marksmanship activity.



A miniature range could be set up at this station, to include:

- a mat,
- a cadet air rifle,
- sample targets,
- a scope,
- a sling, and
- safety goggles / glasses.

PO 407–General Cadet Knowledge

General cadet knowledge provides the cadets with the information required to discuss Proficiency Level Four training opportunities and year four Cadet Summer Training Centre (CSTC) training opportunities.



Examples of information / training aids that could be set up at this station include:

- a list of Proficiency Level Four training enabling objectives, and
- information sheets / posters on year four summer training opportunities.

PO 408–Drill

Drill provides the cadets an opportunity to discuss commanding a flight, identify parade sequence, command a flight on parade and inspect a cadet on parade.



Examples of information / training aids that could be set up at this station include:

- a copy of A-PD-201-000/PT-000, *Canadian Forces Manual Of Drill And Ceremonial*,
- a video of the cadets in the squadron participating in drill, and
- pictures of a cadet being inspected.

PO 409–Instructional Techniques

Instructional techniques provides the cadets with an opportunity to identify methods of instruction, identify elements of a positive learning environment, describe learner needs, explain assessment and instruct a 30-minute lesson.



Examples of information / training aids that could be set up at this station include:

- instructional aids,
- pictures of instructors conducting a lesson, and
- samples from the QSP and IG, and sample lesson plans.

PO 420–Canadian Forces (CF) Familiarization

CF familiarization provides the cadets with an opportunity to describe Canadian air force traditions and identify Royal Canadian Air Force (RCAF) ranks.



Examples of information / training aids that could be set up at this station include:

- a CF mess kit, and
- a Canadian honours chart.

PO 431–Principles of Flight

Principles of flight provides the cadets an opportunity to explain features of wing design and describe flight instruments.



Examples of information / training aids that could be set up at this station include:

- a model of an aircraft wing, and
- examples of flight instruments.

PO 432–Propulsion

Propulsion provides the cadets an opportunity to describe fuel systems, describe propeller systems and engine instruments.



Examples of information / training aids that could be set up at this station include:

- pictures of aircraft components illustrating fuel systems and propeller systems, and
- aircraft engine instruments.

PO 436–Meteorology

Meteorology provides the cadets an opportunity to explain winds, and describe air masses and fronts



Examples of information / training aids that could be set up at this station include:

- a weather map showing fronts,
- pictures of various kinds of weather, and
- a video of winds.

PO 437–Navigation

Navigation provides the cadets an opportunity to define air navigation terms and describe the magnetic compass.

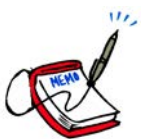

Examples of information / training aids that could be set up at this station include:

- examples of air navigation terms, and
- aircraft compasses or pictures of aircraft compasses.

PO 440–Aerospace

Aerospace provides the cadets an opportunity to identify aerospace materials and describe Canadian satellites.



Examples of information / training aids that could be set up at this station include:

- samples of aerospace materials, and
- pictures of Canadian satellites.

PO 490–Aircrew Survival

Aircrew survival provides the cadets an opportunity to assemble an emergency survival kit, operate a stove and a lantern, tie knots and lashings, navigate to a waypoint using a global positioning system (GPS) receiver, and light fires using improvised methods.

	<p>Examples of information / training aids that could be set up at this station include:</p>
	<ul style="list-style-type: none">• an emergency survival kit,• a stove and a lantern,• a global positioning system (GPS) receiver, and• improvised fire-lighting materials.

ACTIVITY INSTRUCTIONS

1. Have the cadets walk around the classroom for approximately 10 minutes, visiting each station.
2. After the gallery walk, answer any questions that the cadets may have, based on the stations that they have seen.

SAFETY

Nil.

CONFIRMATION OF TEACHING POINT 1

The cadets' participation in the activity will serve as the confirmation of this TP.

Teaching Point 2

Identify Proficiency Level Four complementary training opportunities.

Time: 10 min

Method: Interactive Lecture

Complementary training provides cadets and squadron staff with a variety of topics and activities they can choose based on interest and resources. These lessons are used to complement mandatory training.

PO 401–Citizenship

Complementary training for Citizenship provides the cadets an opportunity to describe the youth justice system and discuss age-based laws, federal and provincial jurisdictions, and computer crime.

PO 402–Community Service

Complementary training for Community Service provides the cadets an opportunity to participate in a ceremonial parade and an additional opportunity to perform community service.

PO 403–Leadership

Complementary training for Leadership provides the cadets an opportunity to participate in a leadership seminar, lead a team-building activity, and deliver a presentation on a leader.

PO 404–Personal Fitness and Healthy Living

Complementary training for personal fitness and healthy living provides the cadets an opportunity to describe nutrition and hydration requirements for fitness and sports activities and conduct the cadet fitness assessment.

PO 405–Recreational Sports

Complementary training for recreational sports provides the cadets an opportunity to participate in an organized sports tabloid, an organized intramural sports event, and an orienteering event.

PO 406–Air Rifle Marksmanship

Complementary training for air rifle marksmanship provides the cadets an opportunity to perform the duties of a range assistant, score targets, identify civilian marksmanship organizations, correct marksmanship error, adopt the standing position with the cadet air rifle, practice holding techniques, practice aiming techniques, practice firing techniques and participate in a recreational marksmanship activity.

PO 407–General Cadet Knowledge

Complementary training for general cadet knowledge provides the cadets an opportunity to prepare for a merit review board and describe the application procedure for national courses and exchanges.

PO 408–Drill

Complementary training for drill provides the cadets an opportunity to discuss the history of drill, view a re-enactment that demonstrates the historical use of drill, execute flag party drill, deliver words of command, practice ceremonial drill as a review and execute drill with arms.

PO 409–Instructional Techniques

Complementary training for Instructional Techniques provides the cadets an opportunity to plan a lesson, instruct a 30-minute lesson, act as an assistant instructor, participate in a creative lesson planning workshop, act as an assistant drill instructor, instruct a 30-minute drill lesson, identify formations for drill instruction, plan a drill lesson and instruct a 15-minute drill lesson.

PO 311–Summer Biathlon

Complementary training for summer biathlon provides the cadets an opportunity to practice aiming and firing the cadet air rifle following physical activity, identify civilian biathlon opportunities, run on alternate terrain, fire the cadet air rifle using a sling following physical activity, participate in a competitive summer biathlon activity, participate in a biathlon briefing, run wind sprints, and participate in a recreational summer biathlon activity.

PO 420–CF Familiarization

Complementary training for CF familiarization provides the cadets an opportunity to describe battle honours of Canadian squadrons and identify honours and awards of the Canadian Forces.

PO 429–Radio Communication

Complementary training for radio communication allows the cadets to explain regulations and operating procedures for aviation transmission and licensing, communicate using radio procedures for aviation transmission, describe radio wavelengths, signals, licenses and equipment, explain emergency, urgency and safety communications, and earn an Industry Canada Radio Operator's Certificate - Aviation (ROC-A) license.

PO 431–Principles of Flight

Complementary training for principles of flight provides the cadets an opportunity to explain flight performance factors, demonstrate turns, climbs, and descents in a flight simulator and fly a radio-controlled aircraft.

PO 431–Propulsion

Complementary training for propulsion provides the cadets an opportunity to describe ignition and electrical systems, describe turbocharging and supercharging systems, and describe gas turbine engines.

PO 436–Meteorology

Complementary training for meteorology provides the cadets an opportunity to explain fog, describe severe weather conditions, and analyze weather information.

PO 437–Navigation

Complementary training for Navigation provides the cadets an opportunity to solve navigation problems with a manual flight computer and use a visual flight rules (VFR) navigation chart (VNC).

PO 440–Aerospace

Complementary training for aerospace provides the cadets an opportunity to describe model rocketry, launch a small rocket, discuss characteristics of the planets in the solar system, apply the material science of trusses, describe robotics, use star charts, operate a telescope, watch *BLAST! (balloon-borne large aperture sub-millimetre telescope)*, describe the relationship between gravity and space-time, discuss kinetic and potential energy, and watch *Einstein's Big Idea*.

PO 460–Aerodrome Operations

Complementary training for aerodrome operations provides the cadets an opportunity to describe aerodrome operations career opportunities, describe air traffic control (ATC) career opportunities, and describe airport security career opportunities.

PO 470–Aircraft Manufacturing and Maintenance

Complementary training for aircraft manufacturing and maintenance provides the cadets an opportunity to discuss aircraft manufacturers, discuss aircraft assembly, identify aviation hardware, and disassemble and reassemble a small engine.

PO 490–Aircrew Survival

Complementary training for Aircrew Survival provides the cadets an opportunity to identify seasonal survival factors, improvise tools for use in a survival situation, move a casualty to shelter, practice safe toolcraft, navigate using a map and compass, erect, tear down and pack a tent, and construct a hootchie or lean-to-style shelter.

CONFIRMATION OF TEACHING POINT 2

QUESTIONS:

- Q1. As part of Citizenship, what are the EOs (topics) that may be taught?
- Q2. What EOs are encompassed under complementary training for Personal Fitness and Healthy Living?
- Q3. In Meteorology, what EOs may be taught?

ANTICIPATED ANSWERS:

- A1. Describe the youth justice system, discuss age-based laws, discuss federal and provincial jurisdictions and discuss computer crime.
- A2. Describe nutrition and hydration requirements for fitness and sports activities, and conduct the cadet fitness assessment.
- A3. Explain winds, describe air masses and fronts, explain fog, describe severe weather conditions, and analyze weather information.

Teaching Point 3**Discuss leadership appointment opportunities at the squadron.**

Time: 5 min

Method: Group Discussion

BACKGROUND KNOWLEDGE

The point of the group discussion is to draw the following information from the group using the tips for answering / facilitating discussion and the suggested questions provided.

LEADERSHIP ASSIGNMENT

A leadership assignment is a specific, short- or long-term practical leadership opportunity during which the team leader must apply their leadership skills. The team leader will have temporary team members either within or outside their peer group for whom they will be responsible. The team will accomplish a singular minor duty or task.

Leadership assignments in fourth year may be the same as third year. Each fourth cadet has already completed at least two leadership assignments during their third year of training.

LEADERSHIP APPOINTMENT

Ensure a list of leadership appointments has been developed by the Training Officer before instructing this class. Below is a sample list of leadership appointments.

A leadership appointment is a specific long-term practical leadership opportunity that is more comprehensive in nature than a leadership assignment. The team leader must apply their leadership knowledge and skills and display the core leadership qualities of a cadet. The team leader will have an assigned, established team of cadets outside their peer group. The team will accomplish a singular major duty or task. These may be organizational appointments (eg, Flight Sergeant, Squadron Commander, etc.), training appointments (eg, Proficiency Level Instructor, Leadership and Ceremonial Instructor, etc.) or supplementary appointments (eg, Canteen Steward, Drill Team Commander, etc.). In generating leadership appointments, consideration must be given to the duration of the major duty or task and frequency of opportunities to exercise leadership. The team leader is expected to meet with their team on a number of occasions over a period of time. Leadership appointments may be held by a single PL4 cadet (eg, Drill Team Commander) or the PL4 cadets may rotate through a position (eg, Canteen Steward). If a PL4 cadet rotates through a leadership appointment, the

appointment must be meaningful for the cadet and be of a duration that allows the cadet to meet the objectives of applying their leadership knowledge and skills and displaying the core leadership qualities of a cadet.

The team leader must supervise team members, communicate with team members and solve problems, strive to meet the needs and expectations of team members, motivate team members, and provide feedback to team members. The team leader must attempt to develop the skills and knowledge of their team members.

Direction for the leadership appointment must be given by a superior usually an activity leader or activity manager.



During year four training, each cadet will be assessed at least once on a leadership assignment and once on a leadership appointment.

SAMPLE YEAR FOUR LEADERSHIP APPOINTMENTS

Organizational Appointments

- Flight Sergeant,
- Flight Commander,
- Squadron Commander,
- Drum Major, and
- Flag Party Commander.

Training Appointments

- Proficiency Level Instructor,
- Aviation Subjects Instructor,
- Leadership and Ceremonial Instructor,
- Fitness and Sports and Instructor,
- Air Rifle Marksmanship Instructor,
- Survival Instructor, and
- Band Section Leader.

Supplementary Appointments

- Supply Assistant,
- Administration Assistant,
- Training Assistant,
- Canteen Steward,
- Drill Team Commander,
- Marksmanship Team Captain,
- Range Assistant,
- First Aid Team Captain,

- Biathlon Team Captain, and
- Sports Team Captain.

GROUP DISCUSSION



TIPS FOR ANSWERING / FACILITATING DISCUSSION:

- Establish ground rules for discussion, eg, everyone should listen respectfully; don't interrupt; only one person speaks at a time; no one's ideas should be made fun of; you can disagree with ideas but not with the person; try to understand others as much as you hope they understand you; etc.
- Sit the group in a circle, making sure all cadets can be seen by everyone else.
- Ask questions that will provoke thought; in other words avoid questions with yes or no answers.
- Manage time by ensuring the cadets stay on topic.
- Listen and respond in a way that indicates you have heard and understood the cadet. This can be done by paraphrasing their ideas.
- Give the cadets time to respond to your questions.
- Ensure every cadet has an opportunity to participate. One option is to go around the group and have each cadet answer the question with a short answer. Cadets must also have the option to pass if they wish.
- Additional questions should be prepared ahead of time.

SUGGESTED QUESTIONS:

- Q1. How do you think suitability for appointments is determined?
- Q2. When is a good time to change a leadership appointment?
- Q3. If a cadet is successful in one appointment is it certain that they will be successful in another appointment? Why or why not?
- Q4. How do you think succession of a leadership appointment should be prepared?



Other questions and answers will develop throughout the group discussion. The group discussion should not be limited to only those suggested.



Reinforce those answers given and comments made during the group discussion, ensuring the teaching point has been covered.

CONFIRMATION OF TEACHING POINT 3

The cadets' participation in the group discussion will serve as the confirmation of this TP.

END OF LESSON CONFIRMATION**QUESTIONS:**

- Q1. What drill training opportunities are mandatory under Proficiency Level Four?
- Q2. What aerospace training opportunities are mandatory under Proficiency Level Four?
- Q3. In Meteorology, what EOs may be taught?

ANTICIPATED ANSWERS:

- A1. Drill provides the cadets with opportunities to discuss commanding a flight, identify parade sequence, command a flight on parade, and inspect a cadet on parade.
 - A2. Aerospace provides the cadets an opportunity to identify aerospace materials and describe Canadian satellites.
 - A3. Explain winds, describe air masses and fronts, explain fog, describe severe weather conditions, and analyze weather information.
-

CONCLUSION

HOMEWORK / READING / PRACTICE

Nil.

METHOD OF EVALUATION

Nil.

CLOSING STATEMENT

Awareness of the topics to be covered in Proficiency Level Four training will help generate interest in the training year. Awareness of the opportunities available throughout the training year may help motivate you in your specific area(s) of interest.

INSTRUCTOR NOTES / REMARKS

For Proficiency Level Four complementary training opportunities in TP 2, refer to the squadron's annual training plan.

This EO should be scheduled as early as possible in the training year. See the example schedule located at A-CR-CCP-804/PG-001, *Proficiency Level Four Qualification Standard and Plan*, Chapter 2, Annex B.

REFERENCES

A0-096 CATO 11-04 Director Cadets 3. (2007). *Cadet program outline*. Ottawa, ON: Department of National Defence.

A3-064 CATO 51-01 Director Cadets 3. (2008). *Air cadet program outline*. Ottawa, ON: Department of National Defence.

THIS PAGE INTENTIONALLY LEFT BLANK

PROFICIENCY LEVEL FOUR POs and EOs	
PO 401–Citizenship	
Recognize How the Legal System Affects Youth	
C401.01	Describe the Youth Justice System
C401.02	Discuss Age-Based Laws
C401.03	Discuss Government Jurisdictions
C401.04	Discuss Computer Crime
PO 402–Community Service	
Perform Community Service	
M402.01	Perform Community Service
C102.01	Participate in a Ceremonial Parade
C102.02	Perform Community Service
PO 403–Leadership	
Act as a Team Leader	
M403.01	Describe Needs and Expectations of Team Members
M403.02	Select a Leadership Approach
M403.03	Motivate Team Members
M403.04	Provide Feedback to Team Members
M403.05	Participate in a Mentoring Relationship
M403.06	Act as a Team Leader During a Leadership Appointment
403 PC	
C403.01	Participate in a Leadership Seminar
C303.01	Lead a Team-Building Activity
C303.02	Deliver a Presentation About a Leader
PO 404–Personal Fitness and Healthy Living	
Update Personal Activity Plan	
M404.01	Participate in the Cadet Fitness Assessment
M404.02	Update Personal Activity Plan
M404.03	Evaluate Personal Activity Plan
C404.01	Describe Nutrition and Hydration Requirements for Fitness and Sports Activities
C404.02	Prepare to Conduct the Cadet Fitness Assessment
C304.01	Participate in the Cadet Fitness Assessment
C304.02	Evaluate Personal Activity Plan
C304.03	Describe Stress
C204.02	Develop a Personal Nutrition Plan
C104.01	Create Team Goals
PO 405–Recreational Sports	
Participate in Recreational Sports	
M405.01	Participate in Organized Recreational Team Sports
C105.01	Participate in an Organized Sports Tabloid
C105.02	Participate in an Organized Intramural Sports Event
C105.03	Participate in an Orienteering Event

PO 406–Air Rifle Marksmanship Fire the Cadet Air Rifle During Recreational Marksmanship	
M406.01	Participate in a Recreational Marksmanship Activity
C406.01	Assist the Range Safety Officer (RSO)
C406.02	Score Air Rifle Marksmanship Targets
C306.01	Identify Civilian Marksmanship Organizations
C306.02	Correct Marksmanship Error
C306.03	Adopt the Standing Position With the Cadet Air Rifle
C106.01	Participate in a Recreational Marksmanship Activity
PO 407–General Cadet Knowledge Serve in an Air Cadet Squadron	
M407.01	Discuss Proficiency Level Four Training Opportunities
M407.02	Discuss Year Four Cadet Summer Training Centre (CSTC) Training Opportunities
C407.01	Prepare for a Merit Review Board
C307.01	Participate in a Presentation Given by a Guest Speaker From the Regional Cadet Support Unit (RCSU)
C307.02	Participate in a Presentation Given by the Cadet Liaison Officer (CLO)
C307.03	Participate in a Presentation Given by a Guest Speaker from the Air Cadet League of Canada (ACLC)
C307.04	Identify the Application Procedures for the Glider and Power Scholarships
C307.05	Participate in a Presentation on the Duke of Edinburgh Award Program
PO 408–Drill Command a Flight on Parade	
M408.01	Discuss Commanding a Flight
M408.02	Identify Parade Sequence
M408.03	Command a Squad
M408.04	Inspect a Cadet on Parade
408 PC	
C408.01	Discuss the History of Drill
C408.02	View a Re-Enactment That Demonstrates the Historical Use of Drill
C308.01	Execute Flag Party Drill
C308.02	Deliver Words of Command
C208.01	Practice Ceremonial Drill as a Review
C208.02	Execute Drill With Arms
PO 409–Instructional Techniques Instruct a Lesson	
M409.01	Identify Methods of Instruction
M409.02	Identify Elements of a Positive Learning Environment
M409.03	Describe Learner Needs
M409.04	Explain Assessment
M409.05	Instruct a 30-Minute Lesson
409 PC	
C409.01	Plan a Lesson
C409.02	Instruct a 30-Minute Lesson
C409.03	Act as an Assistant Instructor
C409.04	Participate in a Creative Lesson Planning Workshop

C409.05	Act as an Assistant Drill Instructor
C409.06	Instruct a 30-Minute Drill Lesson
C309.04	Identify Formations for Drill Instruction
C309.05	Plan a Drill Lesson
C309.06	Instruct a 15-Minute Drill Lesson
PO 311–Summer Biathlon	
Participate in a Recreational Summer Biathlon Activity	
C311.01	Practice Aiming and Firing the Cadet Air Rifle Following Physical Activity
C311.02	Participate in a Recreational Summer Biathlon Activity
C211.01	Identify Civilian Biathlon Opportunities
C211.02	Run on Alternate Terrain
C211.03	Fire the Cadet Air Rifle Using a Sling Following Physical Activity
C211.04	Participate in a Competitive Summer Biathlon Activity
C111.01	Participate in a Biathlon Briefing
C111.02	Run Wind Sprints
C111.03	Fire the Cadet Air Rifle Following Physical Activity
C111.04	Participate in a Recreational Summer Biathlon Activity
PO 420–CF Familiarization	
Describe Canadian Air Force Traditions	
M420.01	Describe Canadian Air Force Traditions
M420.02	Identify Royal Canadian Air Force (RCAF) Ranks
C420.01	Describe Battle Honours of Canadian Squadrons
C420.02	Identify Honours and Awards of the Canadian Forces
PO 429–Radio Communication	
Communicate Using Radio Procedures for Aviation Transmission	
C429.01	Explain Regulations and Operating Procedures for Aviation Transmission and Licensing
C429.02	Communicate Using Radio Procedures for Aviation Transmission
C429.03	Describe Radio Wavelengths, Signals, Licences and Equipment
C429.04	Explain Emergency, Urgency and Safety Communications
429 PC	Industry Canada ROC-A
PO 431–Principles of Flight	
Explain Principles of Flight	
M431.01	Explain Features of Wing Design
M431.02	Describe Flight Instruments
C431.01	Explain Flight Performance Factors
C431.02	Demonstrate Turns, Climbs, and Descents in a Flight Simulator
C431.03	Fly a Radio-Controlled Aircraft
PO 432–Propulsion	
Describe Aero Engine Systems	
M432.01	Describe Fuel Systems
M432.02	Describe Propeller Systems
M432.03	Describe Engine Instruments
C432.01	Describe Ignition and Electrical Systems
C432.02	Describe Turbocharging and Supercharging Systems
C432.03	Describe Gas Turbine Engines

PO 436–Meteorology Explain Aspects of Meteorology	
M436.01	Explain Winds
M436.02	Describe Air Masses and Fronts
C436.01	Explain Fog
C436.02	Describe Severe Weather Conditions
C436.03	Analyze Weather Information
PO 437–Navigation Explain Aspects of Air Navigation	
M437.01	Define Air Navigation Terms
M437.02	Describe the Magnetic Compass
431 / 432 436 / 437 PC	Aviation Subjects–Combined Assessment
C437.01	Solve Navigation Problems with a Manual Flight Computer
C437.02	Use a Visual Flight Rules (VFR) Navigation Chart (VNC)
PO 440–Aerospace Discuss Aerospace Structures	
M440.01	Identify Aerospace Materials
M440.02	Describe Canadian Satellites
C440.01	Describe Model Rocketry
C440.02	Launch a Small Rocket
C440.03	Discuss Characteristics of the Planets in the Solar System
C440.04	Apply the Material Science of Trusses
C440.05	Describe Robotics
C440.06	Use Star Charts
C440.07	Operate a Telescope
C440.08	Watch <i>BLAST! (Balloon-Borne Large Aperture Sub-Millimetre Telescope)</i>
C440.09	Describe the Relationship Between Gravity and Space-Time
C440.10	Discuss Kinetic and Potential Energy
C440.11	Watch <i>Einstein's Big Idea</i>
PO–460 Aerodrome Operations Describe Aerodrome Operations Career Opportunities	
C460.01	Describe Aerodrome Operations Career Opportunities
C460.02	Describe Air Traffic Control (ATC) Career Opportunities
C460.03	Describe Airport Security Career Opportunities
PO–470 Aircraft Manufacturing and Maintenance Discuss Aspects of Aircraft Manufacturing and Maintenance	
C470.01	Discuss Aircraft Manufacturers
C470.02	Discuss Aircraft Assembly
C470.03	Identify Aviation Hardware
C470.04	Disassemble and Reassemble a Small Engine

PO-490 Aircrew Survival Participate in an Aircrew Survival Exercise	
M490.01	Assemble an Emergency Survival Kit
M490.02	Operate a Stove and a Lantern
M490.03	Tie Knots and Lashings
M490.04	Navigate to a Waypoint Using a Global Positioning System (GPS) Receiver
M490.05	Light Fires Using Improvised Ignition
490 PC	
C490.01	Identify Climatic and Seasonal Concerns
C490.02	Improvise Tools for Use in a Survival Situation
C490.03	Move a Casualty to Shelter
C490.04	Practice Safe Toolcraft
C490.05	Navigate a Route Using a Map and Compass
C490.06	Erect, Tear Down and Pack a Tent
C490.07	Construct a Hootchie or Lean-to-Style Shelter

THIS PAGE INTENTIONALLY LEFT BLANK



**ROYAL CANADIAN AIR CADETS
PROFICIENCY LEVEL FOUR
INSTRUCTIONAL GUIDE**



SECTION 2

**EO M407.02 – DISCUSS YEAR FOUR CADET SUMMER
TRAINING CENTRE (CSTC) TRAINING OPPORTUNITIES**

Total Time: 30 min

PREPARATION

PRE-LESSON INSTRUCTIONS

Resources needed for the delivery of this lesson are listed in the lesson specification located in A-CR-CCP-804/PG-001, *Proficiency Level Four Qualification Standard and Plan*, Chapter 4. Specific uses for said resources are identified throughout the instructional guide within the TP for which they are required.

Review the lesson content and become familiar with the material prior to delivering the lesson.

Read CATO 51-01, *Air Cadet Program Outline*.

PRE-LESSON ASSIGNMENT

Nil.

APPROACH

A group discussion was chosen for TP 1 as it allows the cadets to interact with their peers and share their experiences, opinions, and feelings about year four CSTC training opportunities.

An interactive lecture was chosen for TP 2 to orient the cadets to the choices for year four CSTC training opportunities and to generate interest in the subject.

INTRODUCTION

REVIEW

Nil.

OBJECTIVES

By the end of this lesson the cadet shall have discussed year four CSTC training opportunities.

IMPORTANCE

It is important for cadets to identify the year four CSTC training opportunities available to them because it may help them decide if and for which course they would like to apply.

Teaching Point 1

Discuss the areas of interest of CSTC training opportunities.

Time: 10 min

Method: Group Discussion

BACKGROUND KNOWLEDGE



The point of the group discussion is to draw the following information from the group using the tips for answering / facilitating discussion and the suggested questions provided.



Write the specialty areas on a whiteboard / flip chart. Explain the activities that are conducted within each area.

FITNESS AND SPORTS

Cadets will improve individual fitness and sport knowledge and skills. Activities will focus on:

- officiating,
- fitness instruction,
- sports leadership,
- coaching,
- rules and regulations of sports, and
- personal fitness.

MUSIC**Military Band Musician**

Cadets will develop music knowledge and skills. Activities will focus on:

- music theory;
- playing an instrument as part of an ensemble;
- playing an instrument as part of a military band; and
- developing individual music skills.

Pipe Band Musician

Cadets will develop music knowledge and skills. Activities will focus on:

- music theory;
- playing an instrument as part of an ensemble;

- playing an instrument as part of a pipe and drum band; and
- developing individual music skills.

MARKSMANSHIP

Cadets will develop the knowledge and skills required to improve marksmanship and coaching abilities. Activities will focus on:

- recreational and competitive air rifle marksmanship,
- various marksmanship techniques,
- firing positions,
- duties of a range assistant, and
- basic duties of a marksmanship coach.

LEADERSHIP

Cadets will develop the knowledge and skills required to improve leadership abilities in a peer and small group setting. Activities will focus on:

- leadership,
- supervision,
- team-building,
- instructional techniques,
- effective communication,
- problem solving, and
- ceremonial drill.

AVIATION

Cadets will develop the knowledge and skills required to improve their understanding of the fundamentals of aviation. Depending on the course chosen, activities will focus on:

- pilot training,
- meteorology,
- aero engines,
- air navigation,
- airmanship,
- principles of flight,
- navigation,
- pilot decision making,
- air law,

- flight safety, and
- aviation medicine.

AVIATION TECHNOLOGY

Cadets will develop knowledge and skills required to improve their understanding of the fundamentals of aviation technology. Depending on the course chosen, activities will focus on:

- aerodrome operations,
- aircraft fabrication,
- aircraft construction, and
- aircraft maintenance.

AEROSPACE

Cadets will develop knowledge and skills required to improve their understanding of the fundamentals of aerospace science. Activities will focus on:

- theoretical and practical principles of space science,
- simulations of life in space,
- familiarization with recognized space missions, and
- history of space exploration.

AIRCREW SURVIVAL

Cadets will develop the knowledge and skills required to improve aircrew survival skills. Activities will focus on:

- instructional techniques in the field,
- map and compass for ground navigation,
- leadership in a field setting,
- fire construction,
- shelter construction,
- signal construction, and
- food and water collection.

STAFF CADET ADVANCED TRAINING

Staff cadets may not be less than 16 years of age as of the first day of January of the year of advanced training. Staff cadets are not employees. Participation by the staff cadet during authorized CSTC summer training constitutes advanced training.



Cadets can find more information about staff cadet advanced training at CATO 13-28, *Advanced Training—Staff Cadets*.

GROUP DISCUSSION



TIPS FOR ANSWERING / FACILITATING DISCUSSION:

- Establish ground rules for discussion, eg, everyone should listen respectfully; don't interrupt; only one person speaks at a time; no one's ideas should be made fun of; you can disagree with ideas but not with the person; try to understand others as much as you hope they understand you; etc.
- Sit the group in a circle, making sure all cadets can be seen by everyone else.
- Ask questions that will provoke thought; in other words avoid questions with yes or no answers.
- Manage time by ensuring the cadets stay on topic.
- Listen and respond in a way that indicates you have heard and understood the cadet.
- This can be done by paraphrasing their ideas.
- Give the cadets time to respond to your questions.
- Ensure every cadet has an opportunity to participate. One option is to go around the group and have each cadet answer the question with a short answer. Cadets must also have the option to pass if they wish.
- Additional questions should be prepared ahead of time.

SUGGESTED QUESTIONS:

- Q1. Which areas of interest in summer training appeal to you? Why?
- Q2. Who is interested in applying for summer training this year? Why?
- Q3. What extra-curricular CSTC activities did you most enjoy during previous summers? Why?



Other questions and answers will develop throughout the group discussion. The group discussion should not be limited to only those suggested.



Reinforce those answers given and comments made during the group discussion, ensuring the teaching point has been covered.

CONFIRMATION OF TEACHING POINT 1

The cadets' participation in the group discussion will serve as the confirmation of this TP.

Teaching Point 2

Explain the choices for year four CSTC training opportunities.

Time: 15 min

Method: Interactive Lecture

ALL SIX WEEK COURSES OFFERED WITHIN EACH AREA OF COMMON INTEREST

Fitness and Sports Instructor

The aim of the Fitness and Sports Instructor course is to enhance skills developed previously, to develop leadership and instructional skills in fitness and sports settings, and to stimulate further interest in personal fitness and healthy living.

Air Rifle Marksmanship Instructor

The aim of the Air Rifle Marksmanship Instructor course is to enhance skills developed during proficiency level training and previous CSTC training. As well, cadets will develop leadership, coaching, and instructional skills in a marksmanship setting.

Military Band – Advanced Musician

The aim of the Military Band – Advanced Musician course is to enhance knowledge and skills developed during previous music courses, and to develop leadership skills in a military band setting.

Pipe Band – Advanced Musician

The aim of the Pipe Band – Advanced Musician course is to enhance knowledge and skills developed during previous music courses, and to develop leadership skills in a pipe band setting.

ALL SIX WEEK COURSES OFFERED WITHIN EACH ELEMENTAL-SPECIFIC AREA

Leadership and Ceremonial Instructor

The aim of the Leadership and Ceremonial Instructor course is to enhance leadership and ceremonial skills, to develop leadership and instructional skills, and to stimulate further interest in leadership and ceremonial practices.

Survival Instructor

The aim of the Survival Instructor course is to enhance survival skills developed previously, to develop new survival skills, and to develop leadership and instructional skills in a survival / field setting.

Advanced Aerospace

The aim of the Advanced Aerospace course is to enhance aerospace knowledge developed previously, develop new knowledge and skills, and further stimulate an interest in the aerospace / astronomy topics.

Advanced Aviation Technology – Airport Operations

The aim of the Advanced Aviation Technology – Airport Operations course is to enhance knowledge developed previously, develop new knowledge and skills, and further stimulate an interest in airport operations.

Advanced Aviation Technology – Aircraft Maintenance

The aim of the Advanced Aviation Technology – Aircraft Maintenance course is to enhance knowledge developed previously, develop new knowledge and skills, and further stimulate an interest in aircraft maintenance.

Glider Pilot Scholarship (GPS)

The aim of the GPS is to train the successful applicant to the standard as defined in the A-CR-CCP-242/PT-005, *Air Cadet Gliding Manual*. Upon graduation from the course, cadets will be awarded their Air Cadet Glider wings and a Transport Canada Pilot Licence - Glider.

Power Pilot Scholarship (PPS)

The PPS Program is a seven-week course of ground and flying training designed to qualify air cadets for a Transport Canada Private Pilot Licence IAW Canadian Air Regulations. Training is conducted by member flying schools or clubs of either the Air Transport Association of Canada or l'Association québécoise des transporteurs aériens.

THREE-WEEK ADVANCED AVIATION COURSE

The Advanced Aviation course is the only three-week course offered with the completion of Proficiency Level Three. The aim of this course is to enhance the cadet's knowledge of aviation subjects and to further stimulate an interest in becoming a pilot.

PREREQUISITES FOR EACH THREE- AND SIX-WEEK COURSE

For all courses other than the GPS, PPS and Advanced Musician courses, the cadet must:

- be undergoing Proficiency Level Three training by the application deadline;
- successfully complete Proficiency Level Three by June 30 of the year the cadet wishes to attend the CSTC;
- be physically fit;
- complete a Summer Training Application Form;
- have parental consent; and
- be recommended by the squadron Commanding Officer.



Cadets do not have to complete a year three CSTC course to apply for year four CSTC courses.

For more information on the GPS and PPS courses, see EO C307.04 (Identify the Application Procedure for the Glider and Power Pilot Scholarships).

CONFIRMATION OF TEACHING POINT 2

QUESTIONS:

- Q1. What are the five 6-week courses offered in areas of common interest?
- Q2. What is the only three-week course offered during year three or four summer training?
- Q3. What are the prerequisites for three- and six-week courses other than the PPS?

ANTICIPATED ANSWERS:

- A1. Leadership and Ceremonial Instructor, Fitness and Sports Instructor, Air Rifle Marksmanship Instructor, Military Band–Intermediate Musician, and Pipe Band–Intermediate Musician.

A2. The Advanced Aviation course.

A3. For all courses other than the PPS, the cadet must:

- be undergoing Proficiency Level Three training by the application deadline;
- successfully complete Proficiency Level Three by June 30 of the year the cadet wishes to attend the CSTC;
- be physically fit;
- complete a Summer Training Application Form;
- have parental consent; and
- be recommended by the squadron Commanding Officer.

END OF LESSON CONFIRMATION

The cadets' participation in the group discussion will serve as the confirmation of this lesson.

CONCLUSION

HOMEWORK / READING / PRACTICE

Nil.

METHOD OF EVALUATION

Nil.

CLOSING STATEMENT

Summer training is a fun and exciting aspect of the cadet program. CSTCs are also a place to meet cadets and make new friends from different squadrons across Canada. It is important to be familiar with the CSTC training opportunities offered to be able to apply for courses of interest.

INSTRUCTOR NOTES / REMARKS

This EO should be conducted before the summer training application deadline.

It is recommended that the summer training application forms be completed during a training session after this EO has been conducted.

REFERENCES

A0-010 CATO 11-04 Director Cadets 2. (2007). *Cadet program outline*. Ottawa, ON: Department of National Defence.

A0-033 CATO 14-21 Director Cadets 3. (2004). *Music training and education with the Canadian cadet organizations*. Ottawa, ON: Department of National Defence.

A0-128 CATO 13-28 Director Cadets 2. (2006). *Advanced training—Staff cadets*. Ottawa, ON: Department of National Defence.

A3-029 CATO 51-01 Director Cadets 3. (2006). *Air cadet program outline*. Ottawa, ON: Department of National Defence.

A3-061 CATO 54-27 Director Cadets 4. (2007). Power pilot scholarship program. Ottawa: ON: Department of National Defence.

A3-192 CATO 54-26 Director Cadets 4. (2007). Glider Pilot Scholarship Program. Ottawa, ON: Department of National Defence.

THIS PAGE INTENTIONALLY LEFT BLANK



ROYAL CANADIAN AIR CADETS
PROFICIENCY LEVEL FOUR
INSTRUCTIONAL GUIDE



SECTION 3

EO C407.01 – PREPARE FOR A MERIT REVIEW BOARD

Total Time:	90 min
-------------	--------

PREPARATION

PRE-LESSON INSTRUCTIONS

Resources needed for the delivery of this lesson are listed in the lesson specification located in A-CR-CCP-804/PG-001, *Proficiency Level Four Qualification Standard and Plan*, Chapter 4. Specific uses for said resources are identified throughout the instructional guide within the TP for which they are required.

Review the lesson content and become familiar with the material prior to delivering the lesson.

Prepare to conduct merit review boards IAW CATO 13-02, *Cadet Rank Promotions*.

The practice merit review board in TP 3 should be composed of adults who have competent interview skills (officers, civilian instructors and volunteers). Senior cadets should only be used as a last resort.

Obtain the materials for conducting a merit review board for a promotion interview.

Prepare interview questions, marking sheets and candidate scoring sheets (to be created locally) for TP 3.

Arrange for assistant instructors for TP 3.

Obtain a copy of CATO 13-02, *Cadet Rank Promotions*, for each member of the merit review board for promotion.

Photocopy Attachments A and B for each cadet.

PRE-LESSON ASSIGNMENT

Nil.

APPROACH

An interactive lecture was chosen for TPs 1 and 2 to present preparations for merit review boards and to summarize the teaching points.

An in-class activity was chosen for TP 3 as it is an interactive way to provoke thought and stimulate interest among the cadets.

INTRODUCTION

REVIEW

Nil.

OBJECTIVES

By the end of this lesson the cadet shall be expected to prepare for a merit review board.

IMPORTANCE

It is important for cadets to prepare for a merit review board to help them succeed in gaining opportunities through competitive application processes.

Teaching Point 1**Identify occasions requiring a merit review board.**

Time: 5 min

Method: Interactive Lecture

Merit review boards have two important benefits:

- they provide selection recommendations that are fair and open, and
- they provide cadets with a valuable life skill.

Opportunities to conduct merit review boards include:

- promotions,
- awards,
- scholarships, and
- Cadet Summer Training Centre (CSTC) training opportunities, and
- CSTC staff appointments.

PROMOTIONS

CATO 13-02, *Cadet Rank Promotions*, is the authority for this training.

Promotions to higher cadet ranks and appointments within the squadron provide opportunities for merit review boards. Promotion merit review boards have many benefits for the squadron, including:

- giving the candidates incentive to learn details of the rank or appointment responsibilities;
- ensuring that the best candidate is selected; and
- satisfying all members of the squadron that the best available cadet is leading them.

AWARDS

Some squadrons may conduct a merit review board for important awards. Most often, recommendations for awards are made by a board of staff members who are familiar with the work of all candidates. In all cases, recommendations are given to the CO. The CO is the final arbiter of awards.

SCHOLARSHIPS

Scholarship candidates are often selected by the person or entity that is providing the scholarship funding. Squadrons may choose to hold a merit review board for such a purpose.

CSTC TRAINING OPPORTUNITIES

When a squadron has multiple excellent candidates for a limited number of course spaces, selection of candidates must be done in an open manner. The CO requires recommendations that are both unbiased and clearly seen to be unbiased. While staff members can and often do provide effective recommendations, the merit review board provides an unbiased option.

CSTC STAFF APPOINTMENTS

When staff cadets arrive at a CSTC prior to the start of summer training, they may be interviewed by a board. This usually takes one of two forms:

- cadets are interviewed by a panel of officers to determine which CSTC position they are most suited; and
- senior cadets are interviewed by a merit review board for warrant officer positions.

In either case, the interview skills learned at a squadron will prove vital to the cadet.

CONFIRMATION OF TEACHING POINT 1

QUESTIONS:

- Q1. What are two important benefits of merit review boards?
- Q2. What are five occasions in which a cadet might encounter a merit review board?
- Q3. What benefit does a squadron get from holding promotion merit review boards?

ANTICIPATED ANSWERS:

- A1. Merit review boards have two important benefits:
- providing selection recommendations that are fair and open; and
 - providing cadets with a valuable life skill.
- A2. A cadet might encounter a merit review board for:
- promotions,
 - awards,
 - scholarships,
 - CSTC training opportunities, and
 - CSTC staff appointments.
- A3. Promotion merit review boards have many benefits for the squadron, to include:
- giving the candidates incentive to learn details of the rank or appointment responsibilities;
 - ensuring that the best candidate is selected; and
 - satisfying all members of the squadron that the best available cadet is leading them.

Teaching Point 2**Describe how to prepare for a merit review board for promotion and tips for a successful interview.**

Time: 20 min

Method: Interactive Lecture

HOW TO PREPARE FOR A MERIT REVIEW BOARD FOR PROMOTION

A candidate for a merit review board for promotion should:

- think about potential questions that could be asked and prepare answers to these questions;
- talk to others who have been through the process to find out what to expect; and
- participate in any opportunity to practice for a board, such as practice merit review boards.

Dress Requirements

The interview candidate shall identify dress requirements ahead of their interview. The uniform must be worn in accordance with the cadet dress instructions in the relevant Cadet Administration and Training Order (CATO). Dress shall be maintained to a high standard.

TIPS FOR A SUCCESSFUL INTERVIEW**Importance of Bearing**

Many candidates exhibit high standards of dress and high levels of knowledge. The final selections will therefore be based partly on the winning candidates' bearing.

Unless given other instructions, the candidate will enter facing the board, wearing headdress, and salute. Wait until offered a seat and remove headdress when seated.

During the interview, do nothing that may distract the interviewers, to include:

- biting one's lips;
- squirming;
- scratching;
- chewing gum;
- twisting fingers;
- playing with hair;
- checking the time;
- yawning—make sure to have a good night's sleep before the interview; and
- taking anything into an interview that has any chance of distracting the interviewers.

Hand gestures while speaking may also distract interviewers.

Sit with an open posture and legs and arms uncrossed.

The members of the board want the cadet to feel comfortable and relaxed. Try to be so, while maintaining respect and decorum. A confident candidate sits up straight, calmly looking the interviewer straight in the eye without fidgeting. Nodding or shaking the head does not constitute an answer of any kind. All replies must be verbal.

Candidates must be prepared to introduce themselves.

Remember that the interviewers are also going through a process for which they have made long preparations and to which they attach great importance. The candidate being interviewed is, in many ways, part of a team that includes the interviewers. All members of this team are expected to maintain respect, decorum and friendliness.

When the interview is completed, stand, replace headdress, make firm eye contact, salute, and smartly depart the room. The board members may or may not offer to shake hands. Follow their lead.

Merit Review Board for Promotion Questions



Distribute a copy of Attachment A to each cadet.

IAW CATO 13-02, *Cadet Rank Promotions*, question areas at a merit review board for promotion may include:

- candidates recounting their achievements through cadet training (eg, squadron program, CSTC program);
- candidates explaining what previous positions of leadership they have held (eg, at cadets, at school) and how they performed in related situations;
- personal goals and / or their goals for the squadron;
- scenario-based questions that relate to typical squadron situations where the candidate shares how they might approach / deal with the situation; and
- candidate achievements outside of the cadet squadron setting (eg, at school, in their community, sports teams, extracurricular activities).

Candidates are expected to take their time when formulating answers but the answer should be as direct as possible. Ask for clarification when necessary. A comprehensively correct answer, formulated carefully and delivered in a relaxed, friendly manner is best.

If the candidate does not know the answer to a question it is best to say so, in as direct a manner as possible, so the interviewer moves on to another topic where the candidate has better knowledge. This will help minimize both the psychological impact of the missing information and the damage to the candidate's mark. Shoulders must never be shrugged during an interview.



Distribute a copy of Attachment B to each cadet.

CONFIRMATION OF TEACHING POINT 2**QUESTIONS:**

- Q1. How will a candidate know which uniform to wear for a merit review board interview?
- Q2. When should a candidate take a seat in an interview?
- Q3. What should candidates say if the answer to a question is unknown?

ANTICIPATED ANSWERS:

- A1. The interview candidate shall identify dress requirements ahead of their interview.
- A2. When offered a seat.
- A3. It is best to say they do not know, in as direct a manner as possible.

Teaching Point 3

Have the cadets participate in a practice merit review board based on the instructions given in TP 2.

Time: 55 min

Method: In-Class Activity



The practice merit review board should be composed of adults who have competent interview skills (officers, civilian instructors and volunteers). Senior cadets should only be used as a last resort.

ACTIVITY**OBJECTIVE**

The objective of this activity is to have the cadets participate in a practice merit review board.

RESOURCES

- Annex B of CATO 13-02, *Cadet Rank Promotions*,
- Questions for each type of practice merit review board for promotion, prepared locally,
- Marking sheets designed for the locally-prepared questions,
- Candidate scoring sheets, prepared locally,
- Electronic calculator,
- List of practice merit review board candidates showing the type of board, and
- Pens / pencils.

ACTIVITY LAYOUT

In a quiet room:

- place a table and a chair for each interviewer and one chair facing the merit review board for the candidate;
- arrange the lighting to provide the interviewers with a good view of the candidate;
- have the candidate's back to any window or opening to avoid distraction;
- arrange a secure holding area for candidates prior to their interview;
- arrange a separate holding area for candidates following their interview; and
- arrange for a messenger to bring each candidate for their interview as directed by the merit review board.

ACTIVITY INSTRUCTIONS

1. Introduce the practice merit review board members to their room before the activity begins.
2. Ensure that each practice merit review board member has individual resources as needed.
3. Introduce the messenger to the practice merit review board.
4. Explain that the board members will tell the messenger when to bring each candidate.
5. Explain that candidates will be guided to a separate holding area after being interviewed.
6. Have the practice merit review board interview each candidate using the prepared questions.
7. Ensure that there is no contact between candidates who have completed the interview and those who are still waiting.
8. When all candidates have been interviewed, have the board members debrief each candidate individually.
9. Allow each candidate to keep the marking sheets.
10. When all candidates have been interviewed and debriefed, thank the members of the practice merit review board for their time and effort.

SAFETY

Nil.

CONFIRMATION OF TEACHING POINT 3

The cadets' participation in the activity will serve as the confirmation of this TP.

END OF LESSON CONFIRMATION

The cadets' participation in the practice merit review board will serve as the confirmation of this lesson.

CONCLUSION

HOMEWORK / READING / PRACTICE

Have the cadets prepare for a merit review board.

METHOD OF EVALUATION

Nil.

CLOSING STATEMENT

Effective preparation for merit review boards will help you obtain important opportunities. These skills will also prove invaluable throughout life.

INSTRUCTOR NOTES / REMARKS

Cadets will be given scenarios to prepare for a merit review board at the end of TP 2.

In the future, some nationally directed and regionally directed activities may require merit review boards.

When scheduling this lesson, allow at least two weeks between TPs 2 and 3.

REFERENCES

A0-133 CATO 13-02 Director Cadets 3. (2008). *Cadet rank promotions*. Ottawa, ON: Department of National Defence.

A3-006 CATO 55-04 Director Cadets 3. (2005). *Air cadet dress instructions*. Ottawa, ON: Department of National Defence.

C0-416 Air Cadet League of Canada BC Committee (2009). *Sponsoring committee resources: Mock boards*. Retrieved March 4, 2009, from http://www.aircadetleague.bc.ca/SponCommResources/Mock_Boards.PDF

THIS PAGE INTENTIONALLY LEFT BLANK

EXAMPLE QUESTIONS TO EXPECT AT A MERIT REVIEW BOARD FOR PROMOTION

Question areas may include:

- your achievements through cadet training (eg, squadron program, CSTC program);
- previous positions of leadership held (eg, at cadets, at school) and your performance in related situations;
- personal goals and / or your goals for the squadron;
- achievements outside of the cadet squadron setting (eg, at school, in the community, sports teams, extra-curricular activities), and
- scenario-based questions that relate to typical squadron situations and how you might approach / deal with the situation.

All candidates will be asked the same questions, which could be similar to the following examples:

- Describe your current squadron responsibilities.
- Describe your involvement in squadron teams, band and drill, flag party or clubs.
- What leadership positions have you held in any organization?
- What do you consider your own strengths / weaknesses?
- If you had to change something about yourself, what would it be?
- How did you become interested in the cadet movement?
- On an average evening, how much time do you dedicate to homework?
- For what do you use your home computer? (eg, games, research, emails)
- Where are you headed in life?
- Do you plan to take any post-secondary school education?
- What discipline or education do you wish to pursue?
- Do you have a part-time job and, if so, does it compete with cadets or school?
- What community related-activities do you participate in?
- What targets have you set for your personal growth or improvement?
- Do you participate in any organized school teams / groups (eg, band, football)?
- Are you involved with any citizenship activities in your community outside of cadets?
- Do you have any hobbies?
- Scenario-based questions:
 - You have been given responsibility for a group of cadets, some of whom require motivation in uniform care. What will you do?
 - You are in charge of drill instruction and one of your assistant instructors keeps touching cadets when correcting them, despite your instructions to not touch. What do you do?

THIS PAGE INTENTIONALLY LEFT BLANK

PREPARATION FOR A MERIT REVIEW BOARD FOR PROMOTION

A candidate for a merit review board for promotion should:

- think about potential questions that could be asked and prepare answers to these questions;
- talk to others who have been through the process to find out what to expect; and
- participate in any opportunity to practice for a board, such as practice merit review boards.

Dress Requirements

The interview candidate shall identify dress requirements well ahead of their interview. The uniform must be worn in accordance with the cadet dress instructions in the relevant Cadet Administration and Training Order (CATO). Dress shall be maintained to a high standard.

TIPS FOR A SUCCESSFUL INTERVIEW

Importance of Bearing

Many candidates will exhibit high standards of dress and high levels of knowledge. The final selections will therefore be based partly on the winning candidates' bearing.

Unless given other instructions, the candidate will enter facing the board, wearing headdress, and salute. Wait until offered a seat and remove headdress when seated.

During the interview, do nothing that may distract the interviewers, to include:

- biting one's lips;
- squirming;
- scratching;
- chewing gum;
- twisting fingers;
- playing with hair;
- checking the time;
- yawning—make sure to have a good night's sleep before the interview; and
- taking anything into an interview that has any chance of distracting the interviewers.

Hand gestures while speaking will also distract interviewers, making a negative impression.

Sit with an open posture and legs and arms not crossed.

The members of the board want the cadet to feel comfortable and relaxed. Try to be so, while maintaining respect and decorum. A confident candidate will sit up straight, calmly looking the interviewer straight in the eye without fidgeting. Nodding or shaking the head does not constitute an answer of any kind. All replies must be verbal.

Candidates must be prepared to say some introductory words about themselves.

Remember that the interviewers are also going through a process for which they have made long preparations and to which they attach great importance. The candidate being interviewed is, in many ways, part of a team which includes the interviewers. All members of this team are expected to maintain respect, decorum and friendliness.

When the interview is completed, stand, replace headdress, make firm eye contact, salute, and smartly depart the room. The board members may or may not offer to shake hands. Follow their lead.

If the candidate does not know the answer to a question it is best to say so in as direct a manner as possible so the interview moves on to another topic where the candidate has better knowledge. This will minimize both the psychological impact of the missing information and the damage to the candidate's mark. Shoulders must never be shrugged during an interview.



**COMMON TRAINING
PROFICIENCY LEVEL FOUR
INSTRUCTIONAL GUIDE**



SECTION 1

EO M408.01 – DISCUSS COMMANDING A FLIGHT ON PARADE

Total Time:

30 min

PREPARATION

PRE-LESSON INSTRUCTIONS

Resources needed for the delivery of this lesson are listed in the lesson specification located in A-CR-CCP-804/PG-001, *Proficiency Level Four Qualification Standard and Plan*, Chapter 4. Specific uses for said resources are identified throughout the instructional guide within the TP for which they are required.

Review the lesson content and become familiar with the material prior to delivering the lesson.

Photocopy CATO 55-04, *Air Cadet Dress Regulations*, for every three cadets, for reference during the group discussion.

PRE-LESSON ASSIGNMENT

Nil.

APPROACH

A group discussion was chosen for this lesson as it allows the cadets to interact with their peers and share their knowledge and opinions about commanding a flight on parade. Sharing in the discussion encourages the cadets to examine their own thoughts and feelings and may prompt them to re-examine their previously held ideas. Participating in a group discussion improves the cadets' listening skills and team development.

INTRODUCTION

REVIEW

Nil.

OBJECTIVES

By the end of this lesson the cadet shall have discussed commanding a flight on parade.

IMPORTANCE

It is important for cadets to discuss commanding a flight on parade in a professional and confident manner as their performance can positively influence the cadets within the flight. It is important to be aware of the key attributes required to successfully command a flight while on the parade square, such as maintaining a high standard of appearance, presence and bearing.

Teaching Point 1**Discuss commanding a flight on parade.**

Time: 25 min

Method: Group Discussion

BACKGROUND KNOWLEDGE



The point of the group discussion is to draw the following information from the group using the tips for answering / facilitating discussion and the suggested questions provided.



Proficiency Level Four cadets will be given opportunities to fill various parade appointments (eg, Flight Commander, Flight Sergeant). The term team leader has been used throughout this EO to encompass any position.

COMMANDING A FLIGHT ON PARADE

The aim of drill is to contribute to the operational effectiveness of the Cadet Program. This aim can be achieved by ensuring cadets march and manoeuvre on the parade square as one unit and by promoting discipline, alertness, precision, pride and the cohesion necessary for success.

Communicating Effectively

As the team leader, there will be various occasions when effective communication will be required, such as when:

- communicating drill commands; and
- speaking to the flight, in a more informal method.

When speaking to cadets in a flight, clear and positive communication is necessary to aid in achieving the aim of drill. Profanity, personal sarcasm or negative comments shall never be used.

When calling drill commands, the team leader must develop and use a vocabulary of short, concise words to impress on the flight that the movement must be performed smartly. When communicating or referring to drill commands and movements, words to use could include:

- sharp,
- crack,
- drive,
- seize, and
- grasp.

Sharp drill movements are dependent on the words of command being properly delivered. Words of command are to be pronounced clearly and distinctly, with confidence and determination, since they convey an order which is to be promptly obeyed.



When correcting errors, the team leader is to address the cadet in a positive tone. The most effective way to correct errors is to explain and demonstrate the correct method and then have the cadet(s) complete the movement(s) the correct way while being observed. This allows the cadet to learn from their error(s).

Executing Sharp Personal Drill

Team leaders must execute all drill movements confidently, correctly and smartly. The characteristics of drill are efficiency, precision and dignity and these qualities are developed through self-discipline and practice.

Team leaders who display constant proficiency in drill are recognized throughout the Cadet Program as highly trained, well-disciplined and professional. Well executed drill develops individual pride, mental alertness, precision and esprit-de-corps. It also sets the standard for the completion of parades and builds a sense of confidence between the team leader and cadet that is essential to high morale.

Maintaining Dress IAW Dress Instructions

Team leaders shall be well groomed with footwear cleaned and shone. The uniform shall be clean and properly pressed at all times.

Dress instructions help ensure a positive image and a high standard of dress are consistent among all cadets when in uniform. Showcasing a high standard of personal dress, appearance and grooming will aid in exhibiting confidence and reflect that the team leader has knowledge of the dress instructions.



Refer to CATO 55-04, *Air Cadet Dress Regulations* for further information on dress standards.

Exhibiting a Positive Attitude

Team leaders should always exhibit a positive attitude toward the members of the flight while on the parade square because a positive attitude will encourage the cadets to want to follow the example set by the team leader.

The positive attitude taught and developed on and off the parade square must be maintained by the team leader at all times.

Conducting Oneself in an Appropriate Manner

As the team leaders are expected to set the example for the flight, it is important to project an image of discipline and self-control.

Chewing gum, slouching, sauntering, placing hands in pockets and similar deportment that detracts from a proud and orderly appearance are unacceptable for team leaders.



The appearance, presence and bearing of the team leader must be of the highest standard since this example may be imitated by the cadets within the flight.

GROUP DISCUSSION



TIPS FOR ANSWERING / FACILITATING DISCUSSION:

- Establish ground rules for discussion, eg, everyone should listen respectfully; don't interrupt; only one person speaks at a time; no one's ideas should be made fun of; you can disagree with ideas but not with the person; try to understand others as much as you hope they understand you; etc.
- Sit the group in a circle, making sure all cadets can be seen by everyone else.
- Ask questions that will provoke thought; in other words avoid questions with yes or no answers.
- Manage time by ensuring the cadets stay on topic.
- Listen and respond in a way that indicates you have heard and understood the cadet. This can be done by paraphrasing their ideas.
- Give the cadets time to respond to your questions.
- Ensure every cadet has an opportunity to participate. One option is to go around the group and have each cadet answer the question with a short answer. Cadets must also have the option to pass if they wish.
- Additional questions should be prepared ahead of time.

SUGGESTED QUESTIONS:

- Q1. What attributes do you expect from a person when they are commanding a flight? Why?
- Q2. As a member of a flight, what were some of the positive attributes that you noticed / remember about your team leader they were on the parade square?
- Q3. What are some leadership competencies you have noticed in the past as a member of a flight? What competencies should you exhibit when commanding a flight on parade?
- Q4. Have you ever commanded a flight on parade? If so, what did you learn from this experience(s)? What went well when you commanded a flight on parade? What did not go well when you commanded a flight on parade?
- Q5. Why is it important to communicate effectively to the cadets within the flight when commanding a flight on parade?
- Q6. Why is it important to exhibit a positive attitude when commanding a flight on parade?
- Q7. As a team leader it is important to maintain a positive attitude and a high standard of dress? Why?



Write the mentioned / discussed topics on a flip chart and display them for the cadets so they can refer to them.



Other questions and answers will develop throughout the group discussion. The group discussion should not be limited to only those suggested.



Reinforce those answers given and comments made during the group discussion, ensuring the teaching point has been covered.

CONFIRMATION OF TEACHING POINT 1

The cadets' participation in the group discussion will serve as the confirmation of this TP.

END OF LESSON CONFIRMATION

The cadets' participation in the group discussion will serve as the confirmation of this lesson.

CONCLUSION

HOMEWORK / READING / PRACTICE

Nil.

METHOD OF EVALUATION

Nil.

CLOSING STATEMENT

When assigned to command a flight on parade it is important to conduct oneself with professionalism and confidence. A team leader who portrays a high standard of appearance, presence and bearing positively affects how cadets conduct themselves and respond to orders that are given on the parade square.

INSTRUCTOR NOTES / REMARKS

Nil.

REFERENCES

A0-002 A-PD-201-000/PT-000 Director History and Heritage 3-2. (2005). *The Canadian Forces manual of drill and ceremonial*. Ottawa, ON: Department of National Defence.

A3-006 CATO 55-04 Director Cadets 3. (2005). *Air cadet dress instructions*. Ottawa, ON: Department of National Defence.

THIS PAGE INTENTIONALLY LEFT BLANK



**COMMON TRAINING
PROFICIENCY LEVEL FOUR
INSTRUCTIONAL GUIDE**



SECTION 2

EO M408.02 – IDENTIFY PARADE SEQUENCE

Total Time:	30 min
-------------	--------

PREPARATION

PRE-LESSON INSTRUCTIONS

Resources needed for the delivery of this lesson are listed in the lesson specification located in A-CR-CCP-804/PG-001, *Proficiency Level Four Qualification Standard and Plan*, Chapter 4. Specific uses for said resources are identified throughout the instructional guide within the TP for which they are required.

Review the lesson content and become familiar with the material prior to delivering the lesson.

Photocopy the parade sequence from A-CR-CCP-801/PF-001, *Proficiency Level One Instructional Guides*, Chapter 8, Section 13, Annex A, PO 108 (Participate in an Annual Ceremonial Review [ACR] Parade), to distribute during TP 2 to each cadet.

Photocopy the ACR sequence from A-CR-CCP-801/PF-001, *Proficiency Level One Instructional Guides*, Chapter 8, Section 13, Annex D, PO 108 (Participate in an ACR Parade) to distribute during TP 3 as a reference for every three cadets.

Review any regional orders regarding conducting ACR parades.

PRE-LESSON ASSIGNMENT

Nil.

APPROACH

An interactive lecture was chosen for this lesson to orient the cadets to the parade sequences of a parade night and an ACR.

INTRODUCTION

REVIEW

The review for this lesson is from EO M408.01 (Discuss Commanding a Flight on Parade).

QUESTIONS:

- Q1. What are some examples of communicating effectively when commanding a flight on parade?
- Q2. What attributes should a cadet demonstrate when commanding a flight on parade?
- Q3. What are some important aspects of your dress to follow / maintain when commanding a flight on parade?

ANTICIPATED ANSWERS:

- A1. When speaking to cadets in a flight, clear and positive communication is necessary to aid in achieving the aim of drill. When commanding a flight on parade, the team leader must develop and use a vocabulary of short, concise words to impress on the flight that the movement must be performed smartly.
- A2. Some of the attributes would include:
- communicating effectively;
 - executing sharp personal drill;
 - maintaining dress IAW dress instructions;
 - exhibiting a positive attitude; and
 - conducting oneself in an appropriate manner.
- A3. Team leaders shall be well groomed with footwear cleaned and shone. The uniform shall be clean and properly pressed at all times.

OBJECTIVES

By the end of this lesson the cadet shall have identified the parade sequence of a parade night and an ACR.

IMPORTANCE

It is important for cadets to know the sequence of a parade night's opening and closing parades and an ACR as they will be in placed in a team leader role and will need to know the commands, formations and locations of all members on the parade square. Cadets will be looking to their team leader for guidance during a parade night's opening and closing parades and during an ACR.

Teaching Point 1**Discuss the roles of parades within the Cadet Program.**

Time: 5 min

Method: Interactive Lecture



This TP is intended to introduce the many parades that may be conducted within the Cadet Program.



Cadet squadrons may have specific traditions that they follow for some of their parades.

ROLES OF PARADES WITHIN THE CADET PROGRAM

The purpose of parades is to move cadets in an orderly and efficient manner using precise movements required for displays and ceremonies. Parades also showcase the cadets' knowledge of drill to spectators.

Parade Night

Cadet squadrons conduct an opening and closing parades most times when they meet for training, as it allows cadets to take attendance, practice drill and inspect uniforms. These parades also provide an excellent opportunity for announcements, presentation of awards and promotions. Opening and closing parades usually follow the ACR sequence, allowing cadets to learn the ACR sequence throughout the training year.

ACR

Each year, cadet squadrons are required to conduct an ACR parade. The ACR parade provides an opportunity for cadet squadrons to showcase what they have learned that year and to demonstrate their grasp of drill for family, friends and the community.

Remembrance Day

Every year on November 11, Canadians gather at memorials from coast to coast to remember those who have lost their lives in war or peacekeeping missions. Cities across Canada host Remembrance Day ceremonies and are usually attended by government officials, veterans, serving military members, police, cadets and the general public. At a Remembrance Day ceremony, cadet squadrons may march in the parade or provide a guard(s) for the cenotaph or memorial.

Special Ceremonial Parades

Special ceremonial parades may be conducted throughout the cadet training year. The following is a list of special ceremonial parades that may be conducted:

- Battle of Britain,
- Battle of the Atlantic,
- Ceremony of the Flags,
- Change of Command,
- Drumhead Ceremony,
- Freedom of the City,

- Military Funeral,
- Retreat and Tattoo,
- Sunset Ceremony, and
- Trooping the Colour(s).

Drill demonstrations may be performed during special ceremonial parades. Standard drill movements must be used at all times.



Refer to A-PD-201-000/PT-000, *The Canadian Forces Manual of Drill and Ceremonial*, for further information on special ceremonial parades.

CONFIRMATION OF TEACHING POINT 1

QUESTIONS:

- Q1. What is the purpose of parades?
- Q2. What two parades are normally conducted on a parade night?
- Q3. Identify some of the special ceremonial parades that may be conducted.

ANTICIPATED ANSWERS:

- A1. The purpose of parades is to move cadets in an orderly and efficient manner using precise movements required for displays and ceremonies. Parades also showcase the cadets' knowledge of drill to spectators.
- A2. Cadet squadrons conduct an opening and closing parades on a parade night.
- A3. The following is a list of special ceremonial parades that can be conducted:
 - Battle of Britain,
 - Battle of the Atlantic,
 - Ceremony of the Flags,
 - Change of Command,
 - Drumhead Ceremony,
 - Freedom of the City,
 - Military Funeral,
 - Retreat and Tattoo,
 - Sunset Ceremony, and
 - Trooping the Colour(s).

Teaching Point 2**Describe the parade night sequence.**

Time: 10 min

Method: Interactive Lecture



This TP describes the opening and closing parade sequences during a parade night from the view of a team leader commanding a flight on parade.

Distribute to each cadet a copy of the ACR parade sequence located at A-CR-CCP-801/PF-001, *Proficiency Level One Instructional Guides*, Chapter 8, Section 13, Annex A, PO 108 (Participate in an Annual Ceremonial Review [ACR] Parade).

The parade night sequence that is provided in this TP is one way to conduct the parade. Cadet squadron have some flexibility regarding their own routines.

PARADE NIGHT SEQUENCE

It is necessary to know and understand the sequence of the opening and closing parades as a team leader commanding a flight on parade. Team leaders will be required to lead cadets on the parade square through a series of drill commands, formations and movements while effectively communicating.

Opening Parade

The sequence for the opening parade is as follows:

1. **Form up.** Through a series of drill commands, the cadets of the flight will form up for the opening parade.
2. **Roll call.** Attendance is taken by the team leader to determine if cadets are present, excused or absent.
3. **Inspection.** The inspection can be conducted by the team leader, the Cadet Squadron Commander or an officer. In most cases, the team leader conducts the initial inspection of the flight, before the Cadet Squadron Commander or an officer conducts the main squadron inspection.
4. **March past.** This allows the squadron to practice marching for the ACR or any other upcoming parades. As some cadet squadron may not have the required space, a march past may not be possible or is not always required.
5. **Announcements.** This is a good opportunity for any announcements, awards, presentations and / or promotions to be given.



Cadet squadron may present awards or promotions at the opening parade or the closing parade.

6. **Dismissal.** The dismissal signifies the end of the opening parade and the beginning of the training session(s).

Closing Parade

The sequence for the closing parade is as follows:

1. **Form up.** Through a series of drill commands, the cadets of the flight will form up for the closing parade.
2. **Announcements.** This is a good opportunity for any announcements, awards, presentations and / or promotions to be given.

3. **Advance in review order.** This allows the squadron to practice the advance in review order for the ACR and any other upcoming parades. As some cadet squadrons may not have the required space, an advance in review order may not be possible or is not always required.



Final compliments to royalty, senior officials and higher military commanders shall be paid after completing the advance in review order.

4. **Dismissal.** The dismissal signifies the end of the closing parade and the end of the training session.



Refer to PO 108 (Participate in an Annual Ceremonial Review [ACR] Parade) Annex A, for further information.

CONFIRMATION OF TEACHING POINT 2

QUESTIONS:

- Q1. How do team leaders lead cadets on parade?
Q2. What is the sequence for the opening parade?
Q3. What is the sequence for the closing parade?

ANTICIPATED ANSWERS:

- A1. Team leaders lead cadets on parade through a series of drill commands, formations and movements while effectively communicating.
- A2. The sequence for the opening parade is as follows:
- form up;
 - roll call;
 - inspection;
 - march past;
 - announcements; and
 - dismissal.
- A3. The sequence for the closing parade is as follows:
- form up;
 - announcements;
 - advance in review order; and
 - dismissal.

Teaching Point 3**Describe the ACR sequence.**

Time: 10 min

Method: Interactive Lecture



This TP is intended to highlight the ACR sequence from the view of a team leader commanding a flight on parade.

Distribute a copy of the ACR parade sequence located at A-CR-CCP-801/PF-001, *Proficiency Level One Instructional Guides*, Chapter 8, Section 13, Annex D, PO 108 (Participate in an Annual Ceremonial Review [ACR] Parade) to every three cadets. This handout outlines the entire format for an ACR parade sequence.

The ACR format that is provided in this TP is one way to conduct the parade. Cadet squadrons have some flexibility regarding their own routines.

ACR SEQUENCE

The ACR parade provides an opportunity for cadet squadron to showcase what they have learned that year and to demonstrate their grasp of drill for family, friends and the community.

Each year, cadet squadron are required to conduct an ACR parade. The main sections of the parade sequence for the ACR are as follows:

- form up;
- reception of the reviewing officer (RO);
- inspection by the RO;
- march past;
- awards and presentations;
- advance in review order;
- departure of the RO; and
- dismissal.



Upon completion of the march past, squadrons may choose to mount live demonstrations (eg, drill team, music, etc). The reviewing officer's address normally takes place once the squadron has reformed on the parade square. After dismissal, squadrons may invite guests to visit their various static displays.

CONFIRMATION OF TEACHING POINT 3**QUESTIONS:**

- Q1. How often are cadet squadrons required to conduct an ACR parade?
- Q2. What is the purpose of an ACR parade?
- Q3. What is the sequence of the ACR parade?

ANTICIPATED ANSWERS:

- A1. Each year cadet squadrons are required to conduct an ACR parade.
- A2. The ACR parade is an opportunity for cadets to showcase what they have learned that year and to demonstrate their grasp of drill for family, friends and the community.
- A3. The parade sequence for the ACR is as follows:
- form up;
 - reception of the reviewing officer (RO);
 - inspection by the RO;
 - march past;
 - awards and presentations;
 - advance in review order;
 - departure of the RO; and
 - dismissal.
-

END OF LESSON CONFIRMATION

QUESTIONS:

- Q1. What is the purpose of parades?
- Q2. What parade do the opening and closing parade sequences follow?
- Q3. What is the purpose of an ACR parade?

ANTICIPATED ANSWERS:

- A1. The purpose of parades is to move cadets in an orderly and efficient manner using precise movements required for displays and ceremonies. Parades also showcase the cadets' knowledge of drill to spectators.
- A2. Opening and closing parades usually follow the ACR sequence, allowing cadets to learn the ACR sequence throughout the training year.
- A3. The ACR parade is an opportunity for cadets to showcase what they have learned that year and to demonstrate their grasp of drill for family, friends and the community.
-

CONCLUSION

HOMEWORK / READING / PRACTICE

Nil.

METHOD OF EVALUATION

Nil.

CLOSING STATEMENT

When placed in a team leader role it is important to remember that cadets will be looking for guidance and knowledge on the parade square. Team leaders will be expected to guide cadets through a parade night and ACR sequence through a series of drill commands, formations and movements.

INSTRUCTOR NOTES / REMARKS

Nil.

REFERENCES

A0-002 A-PD-201-000/PT-000 Director History and Heritage 3-2 (2005). *The Canadian Forces manual of drill and ceremonial*. Ottawa, ON: Department of National Defence.

THIS PAGE INTENTIONALLY LEFT BLANK



**COMMON TRAINING
PROFICIENCY LEVEL FOUR
INSTRUCTIONAL GUIDE**



SECTION 3

EO M408.03 – COMMAND A SQUAD

Total Time:

30 min

PREPARATION

PRE-LESSON INSTRUCTIONS

Resources needed for the delivery of this lesson are listed in the lesson specification located in A-CR-CCP-804/PG-001, *Proficiency Level Four Qualification Standard and Plan*, Chapter 4. Specific uses for said resources are identified throughout the instructional guide within the TP for which they are required.

Review the lesson content and become familiar with the material prior to delivering the lesson.

Photocopy and fold in half (laminates if possible) the Parade Sequence Aide-Mémoire Card located at Attachment A for each cadet.

PRE-LESSON ASSIGNMENT

Nil.

APPROACH

A demonstration and performance was chosen for this lesson as it allows the instructor to explain and demonstrate the skill of commanding a squad while providing an opportunity for the cadets to practice the skill under supervision.

INTRODUCTION

REVIEW

The review for this lesson is from EO M408.02 (Identify Parade Sequence).

QUESTIONS:

- Q1. What is the sequence for the opening parade?
- Q2. What is the sequence for the closing parade?
- Q3. What is the general sequence of the Annual Ceremonial Review (ACR) parade?

ANTICIPATED ANSWERS:

A1. The sequence for the opening parade is as follows:

- form up;
- roll call;
- inspection;
- march past;
- announcements; and
- dismissal.

A2. The sequence for the closing parade is as follows:

- form up;
- announcements;
- advance in review order; and
- dismissal.

A3. The general parade sequence for the ACR is as follows:

- form up;
- reception of the reviewing officer (RO);
- inspection by the RO;
- march past;
- awards and presentations;
- advance in review order;
- departure of the RO; and
- dismissal.

OBJECTIVES

By the end of this lesson the cadet shall have commanded a squad.

IMPORTANCE

It is important for cadets to command a squad on parade as they will be placed in a team leader role and will need to know the formations and locations of all members on the parade square. Cadets also need to know how to deliver words of command in a clear and concise manner, with confidence and determination, which will affect how cadets in the squad respond to orders.

Teaching Point 1**Explain, demonstrate and have the cadets command a squad.**

Time: 25 min

Method: Demonstration and Performance



This TP is intended to demonstrate to the cadet how to command a squad. For this skill TP, it is recommended that instruction take the following format:

1. Explain and demonstrate the complete skill of commanding a squad while cadets observe, to include:
 - a. falling in;
 - b. greeting the RO to complete the inspection;
 - c. leading the squad on the march past; and
 - d. falling out.
2. Explain and demonstrate each step required to effectively command a squad while on parade.
3. Have each cadet assume the role of team leader and practice each step.
4. Have each cadet assume the role of team leader and practice the complete skill.

Divide the team into two or three groups, if required, for all cadets to command a squad.

This activity shall be conducted IAW A-PD-201-000/PT-000, *The Canadian Forces Manual of Drill and Ceremonial*.

Note: Assistant instructors may be required for demonstration purposes.



Position the cadets around the parade square, as required, so that they can see the movements required to command a squad.



Distribute a copy of the Parade Sequence Aide-Mémoire Card located at Attachment A to each cadet. Cadets may use the card when practicing the skill of commanding a squad.



The term squad is a generic name for a group of cadets, used to teach drill movements. This term can be interchanged with platoon, flight, division or any other applicable elemental or regimental term.

The aim of flight drill is to enable the flight, when it takes its place in the squadron, to carry out any sequence of drill movements that the parade commander orders.



The parade format that is provided in this lesson is one way to conduct the parade. Cadet squadrons have some flexibility, as they may not have the number of cadets required or cadets may have not completed the required training to assume the role of every parade position.

Refer to Annex A of PO 108 (Participate in an Annual Ceremonial Review Parade), for further information on the parade format.



The position of flight sergeant is abbreviated as Flt Sgt.

The rank of Flight Sergeant is abbreviated FSgt.

Falling In

When falling in as a flight sergeant (Flt Sgt), follow the required commands of the squadron warrant officer (Sqn WO) or the deputy parade commander.



If there is no deputy parade commander, the parade commander would complete the required commands and actions.



When assuming the role of a flight commander (Flt Comd), the following additional steps for falling in are to be conducted:

1. The commencement of the promenade begins after the squads have fallen in. The promenade continues until the deputy parade commander or the parade commander is ready to assume command.
2. Flt Comds position themselves five paces in the rear of and centred on the deputy parade commander, at the front of the parade square. Dressing is automatic and Flt Comds are to stand at ease in succession from the right.
3. On the command OFFICERS FALL—IN, by the deputy parade commander, Flt Comds come to attention, turn left and march to their respective squads, approaching their squads from the right flank front (as illustrated in Figure 1).

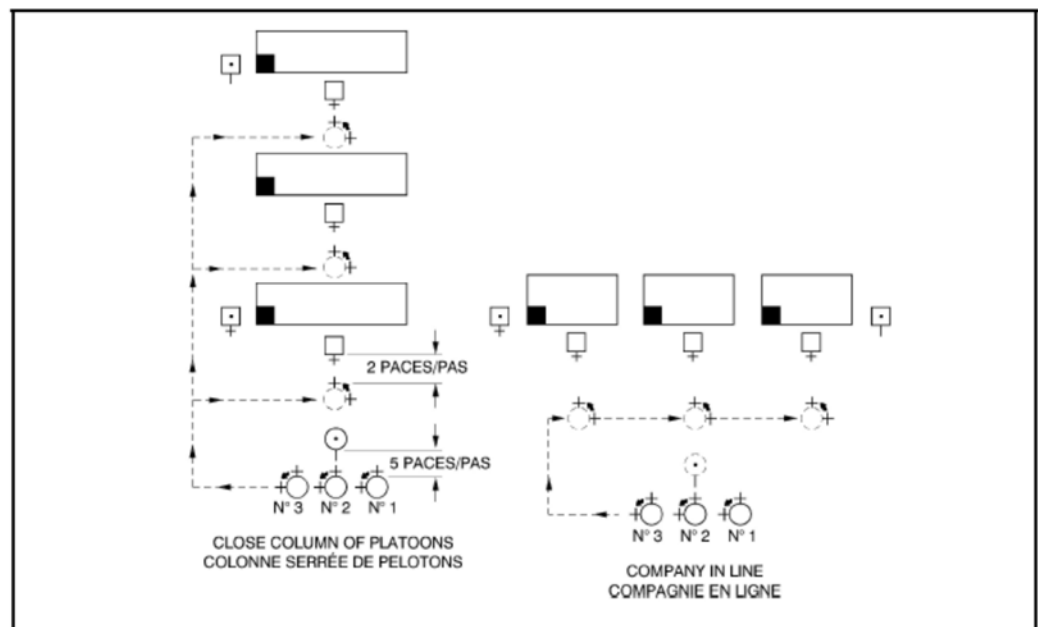

Figure 1 When Officers Fall In

Note. From *The Canadian Forces Manual of Drill and Ceremonial* (p. 7-3-16), by Director History and Heritage 3-2, 2005, Ottawa, ON: Department of National Defence.

4. Flt Comds halt two paces in front of the Flt Sgt, who reports the strength, condition, etc, of the squad. Flt Comds then march forward two paces to take their proper command position after the Flt Sgt has moved to their position behind the squad.



Figure 1 demonstrates the fall-in procedures when a Flt Comd and a Flt Sgt are on parade. Inform the cadets that if no Flt Comd is required to fall in, the Flt Sgt will maintain command of the flight.

Regardless of frontage, when a squad is formed up in line the Flt Comd / Flt Sgt shall be positioned three paces in front and centre of the squad.

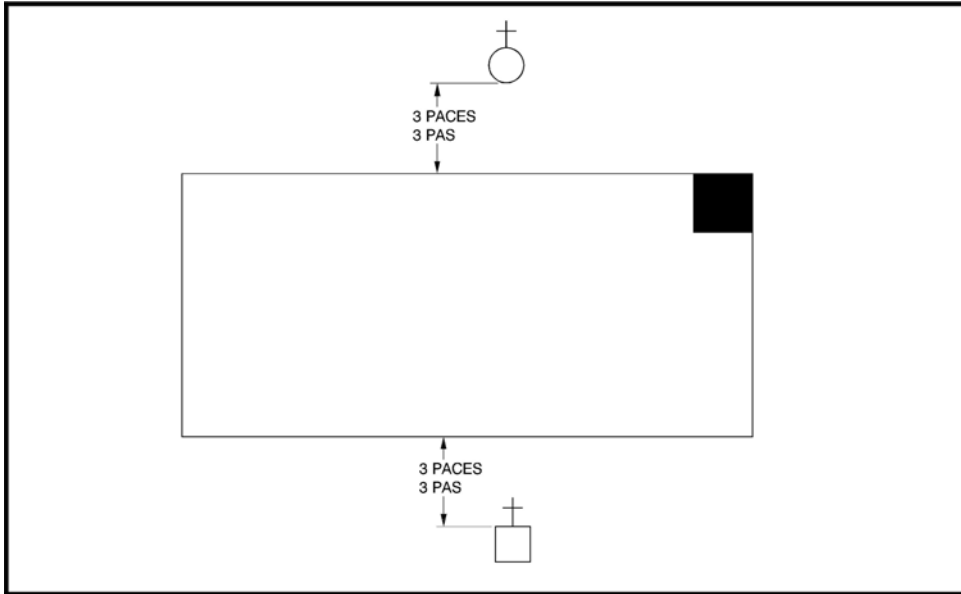

Figure 2 Squad in Line

Note. From *The Canadian Forces Manual of Drill and Ceremonial* (p. 7-2-2), by Director History and Heritage 3-2, 2005, Ottawa, ON: Department of National Defence.





Figure 2 demonstrates the command positions when a Flt Comd and a Flt Sgt are on parade.

When on parade, each squad follows the same procedures to hand over command. Once the Flt Comd / Flt Sgt are in their new position(s), the command STAND AT—EASE, is given in succession from the front (right). On the executive word of command of the last Flt Comd / Flt Sgt ordering their squad to stand at ease, Flt Comd / Flt Sgts turn about and stand at ease together.



Throughout the parade it is important to remember that words of command are to be pronounced clearly and distinctly, with confidence and determination, since they convey an order which is to be promptly obeyed.

Refer to A-CR-CCP-803/PF-001, *Proficiency Level Three Instructional Guides*, EO M308.02 (Deliver Words of Command), if further information is required on how to deliver proper words of command.



When paying compliments during the parade, all salutes must be acknowledged and conducted in a sharp manner.

Greeting the RO to Complete the Inspection

Inspections are conducted one squad at a time, normally accompanied by the RO and the reviewing party. The parade commander will give the command NO. 1 SQUAD, STAND FAST, REMAINDER STAND AT—EASE before the inspection begins. The inspection commences with the squad ordered to stand fast.

As the RO approaches, the Flt Comd / Flt Sgt turns right and marches to a position three paces in front of the marker, facing the RO. When the RO approaches, the Flt Comd / Flt Sgt will salute (if required) and report the squad.



The following is an example opening report from the Flt Comd / Flt Sgt to the RO, when the RO approaches the squad for the inspection.

"Good evening (morning / afternoon) sir (ma'am), Sergeant Jones reporting for number one squad, 25 cadets on parade, ready for your inspection".



If the RO is a local government official, a civilian or a non-commissioned officer (NCO), a salute is not required.

The Flt Comd / Flt Sgt will guide the RO through the front and rear of each rank, commencing at the right flank of the front rank and proceeding in a counter-clockwise direction around each rank in turn. When the RO has completed the inspection, the Flt Comd / Flt Sgt will position themselves behind the rear rank marker, to acknowledge the RO's completion of the squad's inspection, ask permission to carry on and salute (if required).



The following is an example response from Flt Comd / Flt Sgt to the RO, when the RO has completed the inspection of the squad.

"Sir (ma'am), thank you for inspecting number one squad. Permission to carry on?"

Once the RO has begun to move to the next squad, the Flt Comd / Flt Sgt executes a right turn and marches, using a series of wheels, back to their command position facing the squad. When in position the Flt Comd / Flt Sgt shall give the commands CLOSE ORDER—MARCH and STAND AT—EASE. The Flt Comd / Flt Sgt will then turn about to face the front, stand at ease, and await further orders from the parade commander.

As the inspection is being completed, the remaining Flt Comds / Flt Sgts will observe the RO and as the RO inspects the rear rank of the preceding squad, the next Flt Comd / Flt Sgt shall turn about to face their squad, give the command ATTEN—TION and carry out the inspection sequence for their squad.



Inspections are always carried out at the open order.

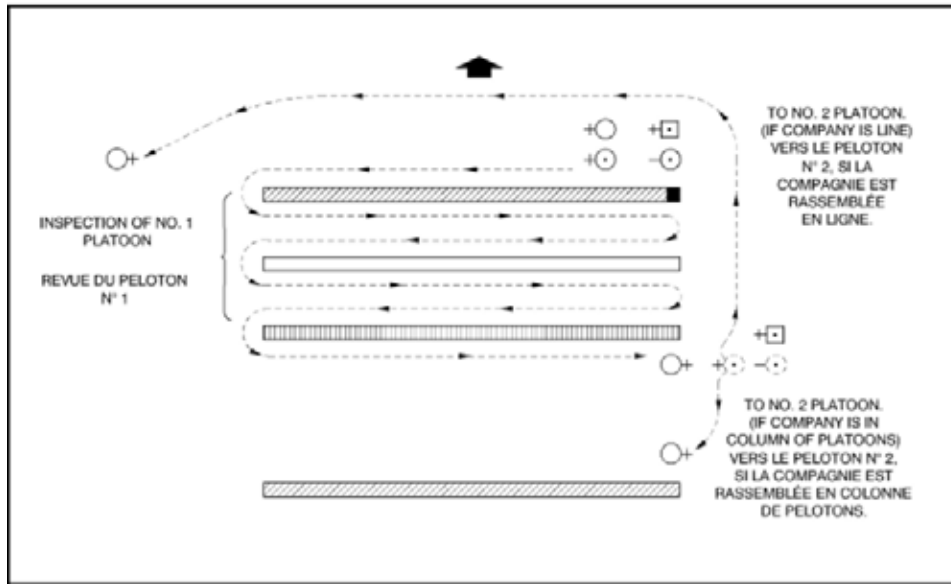

Figure 3 Completing the Inspection

Note. From *The Canadian Forces Manual of Drill and Ceremonial* (p. 7-3-18), by Director History and Heritage 3-2, 2005, Ottawa, ON: Department of National Defence.

Leading the Squad on the March Past

March pasts may be conducted in column of route or in column of threes, depending on time and space available, level of training and the occasion. The simplest march past is column of route in quick time.

Throughout the march past, when commanded by the parade commander, the Flt Comd / Flt Sgt may be required to give the command EYES—RIGHT and EYES—FRONT to their respective squad.



The commands EYES—RIGHT and EYES—FRONT, will be given on the left foot.



If there are turns on the march past, the Flt Comd / Flt Sgt may be required to give the commands RIGHT—TURN (called on the left foot) and / or LEFT—TURN (called on the right foot), when directed by the parade commander.

At the end of the march past, the command HALT (called on the left foot) may also be required to be given, when directed by the parade commander.

Column of route. The Flt Comd / Flt Sgt is two paces in front of the centre single file of the squad. Column of route is the formation most commonly used to move squads on the march.

When halted in this position and given the command to turn, the Flt Comd / Flt Sgt will turn in the appropriate direction, observe the standard pause and march, using a series of wheels, to their appropriate position(s).

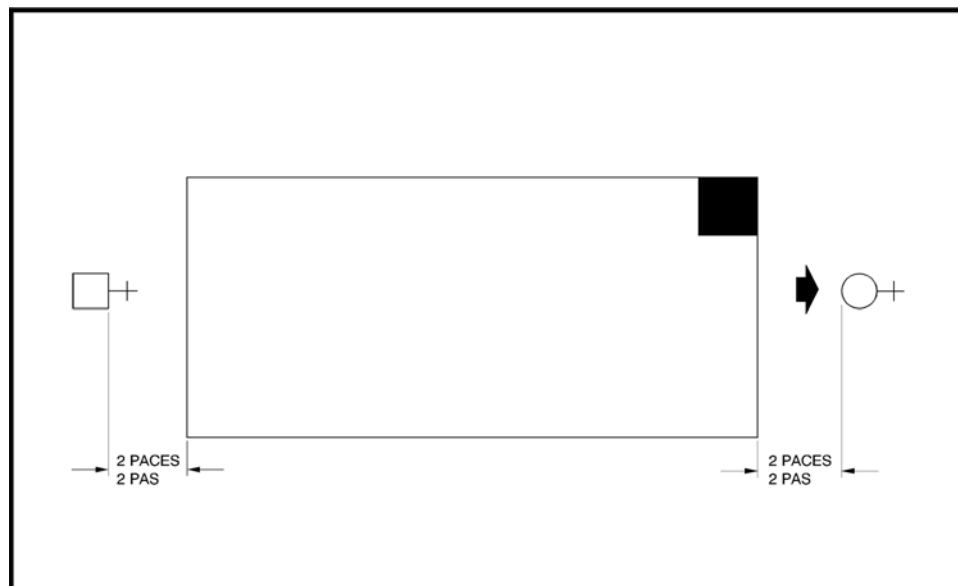

Figure 4 Squad in Column of Route

Note. From *The Canadian Forces Manual of Drill and Ceremonial* (p. 7-2-4), by Director History and Heritage 3-2, 2005, Ottawa, ON: Department of National Defence.



Figures 4 and 5 demonstrate the command positions when a Flt Comd and a Flt Sgt are on parade for the march past, in column of route. If there is no Flt Comd, the Flt Sgt will command the flight.

Column of threes. A squad in column of threes is in the same formation as when in line, but facing a flank. Column of threes is another formation used to move a squad on the march.

When halted in this position and given the command to turn, the Flt Comd / Flt Sgt turn in the appropriate direction and maintain their position(s).

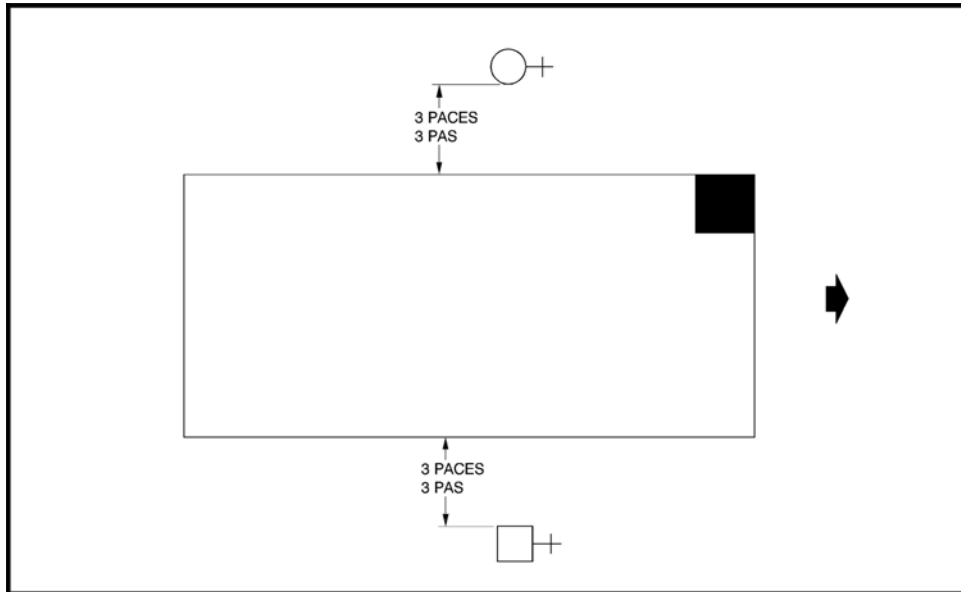

Figure 5 Squad in Column of Threes

Note. From *The Canadian Forces Manual of Drill and Ceremonial* (p. 7-2-3), by Director History and Heritage 3-2, 2005, Ottawa, ON: Department of National Defence.

Falling Out

When falling out as a Flt Sgt, follow the commands of the Sqn WO or the deputy parade commander.



When assuming the role of a Flt Comd, the following additional steps of falling out are to be conducted:

1. On the command OFFICERS, FALL—OUT, which is given by the parade commander when the parade is at attention, the Flt Comd marches the most direct route and forms up in a line, five paces in front of, centred on and facing, the parade commander, at arm's length interval (without raising the arm), the deputy parade commander on the right.
2. When all Flt Comds are present and in line, the deputy parade commander takes a half pace forward.
3. When ordered by the parade commander to DIS—MISS, the deputy parade commander will step back one half pace. All Flt Comds will observe the standard pause and march straight forward off the parade square, along with the deputy parade commander.

CONFIRMATION OF TEACHING POINT 1

The cadets' commanding a squad will serve as the confirmation of this TP.

END OF LESSON CONFIRMATION

The cadets' commanding a squad will serve as the confirmation of this lesson.

CONCLUSION

HOMEWORK / READING / PRACTICE

Nil.

METHOD OF EVALUATION

This lesson is assessed IAW A-CR-CCP-804/PG-001, *Proficiency Level Four Qualification Standard and Plan*, Chapter 3, Annex B, 408 PC.

CLOSING STATEMENT

Commanding a squad on parade with confidence and determination, will affect how cadets respond to the orders given. Delivering words of command, in a clear and concise manner allows a squad to move as a team in an organized and efficient manner.

INSTRUCTOR NOTES / REMARKS

Where there are a large number of cadets, divide the group into two or three squads and rotate the cadets through as commanders.

REFERENCES

A0-002 A-PD-201-000/PT-000 Director History and Heritage 3-2. (2005). *The Canadian Forces manual of drill and ceremonial*. Ottawa, ON: Department of National Defence.

THIS PAGE INTENTIONALLY LEFT BLANK

PARADE SEQUENCE AIDE-MÉMOIRE CARD



PARADE SEQUENCE AIDE-MÉMOIRE CARD

FALLING IN

When falling in as a Flt Sgt:

Follow the required commands of the Sqn WO or the deputy parade commander.

When falling in as a Flt Comd:

1. Stand at ease in succession from the right, once in position.
2. On the command to fall in, come to attention, turn left and march to the flight, approaching from the right flank.
3. Halt two paces in front of Flt Sgt.
4. March two paces forward (assume the proper command position) and give the command **STAND AT—EASE**.
5. On the executive word of command of the last flight ordered to stand at ease, turn about and stand at ease.

GREETING THE RO TO COMPLETE THE INSPECTION

1. Ensure the flight is at attention. Give the command **ATTEN—TION** (if required).
2. Turn right and move to a position three paces in front of the marker (check RO's position as required).
3. Salute the RO (if required) and report the flight (eg, "Good evening [morning / afternoon] sir [ma'am], Sergeant Jones reporting for number one flight, 25 cadets on parade, ready for your inspection").
4. Guide the RO through the ranks.
5. After the inspection, stand to attention behind the rear rank marker and salute (if required) and respond to the RO (eg, "Sir [ma'am], thank you for inspecting number one flight. Permission to carry on?").
6. Execute a turn and march back to the front of the flight.
7. Give commands **CLOSE ORDER—MARCH** and **STAND AT—EASE** to the flight.
8. Turn about to face front, stand at ease and await further orders from the parade commander.

LEADING THE FLIGHT ON THE MARCH PAST

- Execute all commands given by the parade commander, as per the parade sequence.
- Assume the correct command positions throughout the march past.
- Give the commands **LEFT—TURN** (as required), **EYES—RIGHT**, **EYES—FRONT**, **RIGHT—TURN** (as required) and **HALT** (as required), as directed by the parade commander.

FALLING OUT

When falling out as a Flt Sgt:

Follow the required commands of the Sqn WO or the deputy parade commander.

When falling out as a Flt Comd:

- On the command to fall out, march the most direct route and form up in position facing the parade commander.
- On the command to dismiss, observe the standard pause and march straight off parade square.

THIS PAGE INTENTIONALLY LEFT BLANK



**COMMON TRAINING
PROFICIENCY LEVEL FOUR
INSTRUCTIONAL GUIDE**



SECTION 4

EO M408.04 – INSPECT A CADET ON PARADE

Total Time:

60 min

PREPARATION

PRE-LESSON INSTRUCTIONS

Resources needed for the delivery of this lesson are listed in the lesson specification located in A-CR-CCP-804/PG-001, *Proficiency Level Four Qualification Standard and Plan*, Chapter 4. Specific uses for said resources are identified throughout the instructional guide within the TP for which they are required.

Review the lesson content and become familiar with the material prior to delivering the lesson.

Photocopy CATO 55-04, *Air Cadet Dress Instructions* and the Dress Instructions Activity Worksheet located at Attachment A, for every three cadets.

Photocopy the Dress Instructions Checklist located at Attachment C for each cadet.

PRE-LESSON ASSIGNMENT

Nil.

APPROACH

An in-class activity was chosen for TP 1 as it is an interactive way to provoke thought and stimulate interest and confirm comprehension of elemental dress instructions.

A demonstration and performance was chosen for TP 2 as it allows the instructor to explain and demonstrate the skill of inspecting a cadet on parade while providing an opportunity for the cadets to practice the skill under supervision.

INTRODUCTION

REVIEW

The review for this lesson is from EO M408.03 (Command a Squad).

QUESTIONS:

- Q1. Regardless of frontage, when a squad is formed up in line, how many paces must the flight commander / flight sergeant be positioned when in front and centre of the squad?
- Q2. What is an example report when the reviewing officer (RO) approaches the squad for the inspection?
- Q3. When commanding the squad as a team leader, what is the team leader responsible for?

ANTICIPATED ANSWERS:

- A1. When a squad is formed up in line the flight commander / flight sergeant shall be positioned three paces in front and centre of the squad.
- A2. "Good evening (morning / afternoon) sir (ma'am), Sergeant Jones reporting for number one squad, 25 cadets on parade, ready for your inspection".
- A3. When commanding a squad, the team leader is responsible for:
- falling in;
 - greeting the RO to complete the inspection;
 - leading the squad on the march past; and
 - falling out.

OBJECTIVES

By the end of this lesson the cadet shall be expected to inspect a cadet on parade.

IMPORTANCE

It is important for cadets to be able to inspect a cadet on parade as they will be placed in a team leader role and will need to know how to effectively correct errors and evaluate dress, IAW CATO 55-04, *Air Cadet Dress Instructions*. Team leaders must maintain a high standard of appearance and bearing, as cadets will be looking to their team leader for examples, guidance and knowledge when it comes to wearing the elemental cadet uniform.

Teaching Point 1**Conduct an activity where the cadets will, in groups of three, identify the correct way of wearing the cadet uniform.**

Time: 15 min

Method: In-Class Activity



Refer to CATO 55-04, *Air Cadet Dress Regulations* for background information. CATOs can be found online at www.cadets.gc.ca.

ACTIVITY**OBJECTIVE**

The objective of this activity is to have the cadets, in groups of three, identify the correct way of wearing the cadet uniform.

RESOURCES

- Dress Instructions Activity Worksheet located at Attachment A (one per group),
- CATO 55-04, *Air Cadet Dress Instructions* (one per group),
- Dress Instructions Activity Worksheet Answer Sheet located at Attachment B,
- Tables (one per group),
- Chairs (one per cadet), and
- Pen / pencil (one per group).

ACTIVITY LAYOUT

Set up the drill hall or outdoor parade square with tables and chairs for group work, with the required resources for each group to complete their activity worksheet.

ACTIVITY INSTRUCTIONS

1. Divide the cadets into groups of three.
2. Distribute the Dress Instructions Activity Worksheet to each group.
3. Allow each group five minutes to answer the questions on their worksheet.
4. Circulate and assist the cadets as necessary, offering suggestions and advice. Refer to the Dress Instructions Activity Worksheet Answer Sheet, as required.
5. Distribute a copy of CATO 55-04, *Air Cadet Dress Instructions* to each group.
6. Have the cadets, within the group, discuss and confirm their answers from their group activity worksheet.
7. Allow the groups five minutes to check their answers on their worksheet.
8. Review the answers with the class.

SAFETY

Nil.

CONFIRMATION OF TEACHING POINT 1

The cadets' participation in the activity will serve as the confirmation of this TP.

Teaching Point 2

Explain, demonstrate and have the cadets perform an individual inspection.

Time: 35 min

Method: Demonstration and Performance



This TP is intended to demonstrate how to perform an individual inspection and to aid the cadets' comprehension of the inspection process as a team leader. For this skill TP, it is recommended that instruction take the following format:

1. Explain and demonstrate the complete skill of performing an individual inspection while cadets observe, to include:
 - a. inspecting the front of the cadet from head to toe;
 - b. inspecting the back of the cadet from head to toe; and
 - c. correcting errors verbally, as required.
2. Explain and demonstrate each step required to effectively perform an individual inspection.
3. Have each cadet assume the role of team leader and practice each step.
4. Have each cadet assume the role of team leader and practice the complete skill.

Divide the team into two equal groups, if required, for all cadets to assume the role of a team leader inspecting a squad.

Note: Assistant instructors may be employed for demonstration purposes.



This activity will be conducted IAW A-PD-201-000/PT-000, *The Canadian Forces Manual of Drill and Ceremonial*.

Distribute a copy of the Dress Instruction Checklist located at Attachment C to each cadet, as a reference when assuming the role of team leader inspecting a squad.



In this TP, the role of flight commander is referred to as the team leader.

Inspections shall be carried out at the open order. Ranks shall be dressed after the open order, before the inspection and after the close order. The individual performing the inspection will inspect the front and rear of the rank, commencing at the front rank marker and proceeding in a counter-clockwise direction around each rank in turn.

Ranks that are being inspected are in the position of attention and ranks within the same flight that are not being inspected, may be ordered to stand at ease. Similarly, during the inspection of one or more squads, the squads that are not being inspected may be ordered to stand at ease. During an inspection, an individual ordered to adjust clothing or equipment shall do so immediately, maintaining their current position within the ranks. After the adjustment is finished, the position of attention will be resumed.

INSPECTING THE FRONT OF A CADET FROM HEAD TO TOE

Inspecting the front of the cadet shall commence at the head and work down to the feet to determine that the cadet:

- is properly equipped for the parade, with clothing and equipment clean and in good repair;
- is properly dressed, with all clothing, badges, ribbons, etc, worn correctly; and
- has a high standard of personal hygiene and grooming.

INSPECTING THE BACK OF A CADET FROM HEAD TO TOE

Inspecting the back of the cadet is done in the same manner as inspecting the front; commence at the head and work down to the feet. The individual performing the inspection is also checking that the cadet is properly dressed and equipped with a high standard of personal hygiene.

CORRECTING ERRORS VERBALLY

Speak to cadets clearly and positively to ensure maximum learning and understanding of the dress instructions.

When correcting errors, the team leader(s) is to address the cadet in a positive tone. Explain and demonstrate the correct method and have the cadet complete the correction (providing it is a minor correction / adjustment that can be done while the cadet is in ranks). This method will allow the cadet to learn from their error(s).



When correcting errors, never touch the cadet. Either ask permission to touch the cadet's uniform or demonstrate how to correct the error using one's own uniform.

CONFIRMATION OF TEACHING POINT 2

The cadets' performance of an individual inspection will serve as the confirmation of this TP.

END OF LESSON CONFIRMATION

The cadets' performance of an individual inspection will serve as the confirmation of this lesson.

CONCLUSION

HOMEWORK / READING / PRACTICE

Nil.

METHOD OF EVALUATION

Nil.

CLOSING STATEMENT

When placed in a team leader role, it is important to remember that cadets will be looking for examples, guidance and knowledge regarding the elemental cadet dress instructions. Team leaders who portray a high standard of appearance and bearing are able to effectively evaluate dress and correct errors in a positive manner.

INSTRUCTOR NOTES / REMARKS

Nil.

REFERENCES

A0-002 A-PD-201-000/PT-000 Director History and Heritage 3-2. (2005). *The Canadian Forces manual of drill and ceremonial*. Ottawa, ON: Department of National Defence.

A3-006 CATO 55-04 Director Cadets 3. (2005). *Air cadet dress instructions*. Ottawa, ON: Department of National Defence.

DRESS INSTRUCTIONS ACTIVITY WORKSHEET

Instructions: Circle TRUE or FALSE for each question. After all questions have been answered, read through CATO 55-04, *Air Cadet Dress Instructions*, to confirm the answers.

1.	There are three occasions when cadets are permitted to wear their uniforms. TRUE or FALSE
2.	Cadet medals are worn on the right side of the dress uniform jacket. TRUE or FALSE
3.	Cadets are not authorized to wear makeup while in uniform. TRUE or FALSE
4.	For ceremonial purposes, buttons other than plastic blue buttons distributed with the uniform jacket may be authorized for wear by the CO RCSU. TRUE or FALSE
5.	The double overhand knot is to be used to tie the necktie. TRUE or FALSE
6.	The Supply Officer is to ensure that the cadets are dressed in accordance with the CATOs. TRUE or FALSE
7.	The wedge shall be worn evenly when positioned on the head. TRUE or FALSE
8.	Air Cadets are authorized to wear wedge insignia other than the metal or woven wedge insignia. TRUE or FALSE
9.	The Remembrance Day poppy is to be placed / pinned and centred on the top left pocket flap of the cadet dress jacket. TRUE or FALSE
10.	Civilian backpacks must never be carried or worn while in uniform. TRUE or FALSE
11.	Metal wings or silver and gold braided thread wings may be worn. TRUE or FALSE
12.	The name tag is exactly 7 cm in length. TRUE or FALSE
13.	The wearing of squadron anniversary pins on the air cadet uniform is forbidden. TRUE or FALSE

14. The belt on the dress uniform jacket shall be adjusted so that the excess of the belt is no more than 6 cm.

TRUE or FALSE

15. The length of the trousers should extend to the 3rd eyelet of the parade boot.

TRUE or FALSE

DRESS INSTRUCTIONS ACTIVITY WORKSHEET ANSWER SHEET

1. There are three occasions when cadets are permitted to wear their uniforms.

ANSWER: TRUE

PARAGRAPH NUMBER: 26 (a), (b) and (c)

FURTHER INFORMATION: Cadets shall wear their uniform when:

- a. attending training or proceeding to or from a place of training unless directed by the squadron CO;
- b. proceeding to or from a CSTC; and
- c. attending ceremonies or functions at which the wearing of uniform is appropriate and authorized by the cadets squadron or CSTC CO.

2. Cadet medals are worn on the right side of the dress uniform jacket.

ANSWER: TRUE

PARAGRAPH NUMBER: TBD

FURTHER INFORMATION: Medals shall be suspended above the right breast pocket of the jacket, immediately above and centred. When two or more medals are awarded, they shall be worn in order of precedence, without interval, with the highest priority medal closest to the centre of the chest. Medals shall hang in one row so that they are fully visible. Should this not be possible because of the number being worn, medals shall be overlapped horizontally, the one with the highest priority showing in full. Normally, five or more medals will require overlapping. The maximum width of the mounting is governed by the physique of the individual. The bar shall not project beyond the arm seam of the jacket once the mounting is centred with the jacket pocket.

3. Cadets are not authorized to wear makeup while in uniform.

ANSWER: FALSE

PARAGRAPH NUMBER: 35

FURTHER INFORMATION: Female cadets are authorized to wear a minimal amount of make-up. When in uniform, make-up shall be applied conservatively. This precludes the use of false eyelashes, heavy eyeliner, brightly coloured eye shadow or lipstick, coloured nail polish, and excessive facial make-up.

4. For ceremonial purposes, buttons other than plastic blue buttons distributed with the uniform jacket may be authorized for wear by the CO RCSU.

ANSWER: FALSE

PARAGRAPH NUMBER: 28 (l)

FURTHER INFORMATION: Only those plastic blue buttons distributed with the uniform jacket may be worn.

5. The double overhand knot is to be used to tie the necktie.

ANSWER: FALSE

PARAGRAPH NUMBER: 28 (h)

FURTHER INFORMATION: The necktie shall be knotted neatly using a Windsor or four-in-hand knot and shall be kept tight.

6. The Supply Officer is to ensure that the cadets are dressed in accordance with the CATOs.

ANSWER: FALSE

PARAGRAPH NUMBER: 2

FURTHER INFORMATION: Squadron COs shall ensure that cadets under their command are dressed in accordance with CATO 55-04.

7. The wedge shall be worn evenly when positioned on the head.

ANSWER: FALSE

PARAGRAPH NUMBER: 28 (b)

FURTHER INFORMATION: The wedge shall be worn on the right side of the head, lower point of the front crease in the centre of the forehead and with the front edge of the cap 2.5-cm above the right eyebrow.

8. Air Cadets are authorized to wear wedge insignia other than the metal or woven wedge insignia.

ANSWER: FALSE

PARAGRAPH NUMBER: 28 (c)

FURTHER INFORMATION: Air Cadets are not authorized to wear other insignia.

9. The Remembrance Day poppy is to be placed / pinned and centred on the top left pocket flap of the cadet dress jacket.

ANSWER: TRUE

PARAGRAPH NUMBER: 51

FURTHER INFORMATION: The Remembrance Day poppy is authorized to be worn on all numbered orders of dress of the cadet uniform from the last Friday of October until Remembrance Day (11 November). On the cadet jacket the poppy shall be pinned and centred on the top left pocket flap, or in a similar position on the all-season jacket. When medals are worn, the poppy shall be worn centred just above the medals or if worn, over the pilot wings.

10. Civilian backpacks must never be carried or worn while in uniform.

ANSWER: FALSE

PARAGRAPH NUMBER: 16 (n)

FURTHER INFORMATION: Civilian pattern backpack, of conservative appearance, may either be carried in the left hand or worn suspended from both shoulders and square on the back. No item will be suspended from the backpack and straps shall not be left loose.

11. Metal wings or silver and gold braided thread wings may be worn.

ANSWER: TRUE

PARAGRAPH NUMBER: 16 (a) and (b)

FURTHER INFORMATION: Metal wings may be obtained from the Air Cadet League (ACL). They may be worn on the short-sleeve shirt only with all orders of dress, except for cadets on courses at CSTCs. Silver and gold braided thread wings may be obtained from the ACL. They are worn only on the jacket in lieu of wings presented upon completion of the Power Pilot or Glider Pilot Scholarship.

12. The name tag is exactly 7 cm in length.

ANSWER: FALSE

PARAGRAPH NUMBER: 16 (c)

FURTHER INFORMATION: The name tag shall be detachable, made of blue and white laminated plastic plate, 6.3 cm in length and 1.2 cm in height, inscribed with white lettering 0.6 cm high.

13. The wearing of squadron anniversary pins on the air cadet uniform is forbidden.

ANSWER: FALSE

PARAGRAPH NUMBER: 52

FURTHER INFORMATION: Regional Cadet Support Unit (RCSU) CO may authorize the wear of pins that are produced locally, and at no cost to the public, to commemorate the anniversary of a sqn, CSTC or RGS.

14. The belt on the dress uniform jacket shall be adjusted so that the excess of the belt is no more than 6 cm.

ANSWER: FALSE

PARAGRAPH NUMBER: 28 (m)

FURTHER INFORMATION: The jacket belt shall be worn so as the excess of the belt, once attached, is on the left side of the buckle. The buckle shall be adjusted so that the excess of the belt on the left side is not more than 8 cm.

15. The length of the trousers should extend to the 3rd eyelet of the parade boot.

ANSWER: TRUE

PARAGRAPH NUMBER: 29 (n)

FURTHER INFORMATION: The length of the trousers should extend to the 3rd eyelet of the boot.

THIS PAGE INTENTIONALLY LEFT BLANK

DRESS INSTRUCTIONS CHECKLIST

CADET'S NAME _____ **FLIGHT** _____

Uniform Items / Accessories	Check (✓) if Item is Clean / Pressed / Polished	Additional Comments
HEADRESS		
Wedge / Turban and Insignia		
CLOTHES ON THE UPPER BODY		
Badges (proper placement and sewn on correctly)		
Cadet Slip-on or Armlet		
Shirt, Cadet, Short Sleeve		
Turtleneck Sweater		
Uniform Jacket and Belt		
Necktie		
Name Tag		
CLOTHES ON THE LOWER BODY		
Trousers and Belt		
FOOTWEAR		
Parade Boots (with grey wool socks)		
OVERALL PERSONAL APPEARANCE		
Hair (includes facial hair)		
Makeup, Jewellery, Sunglasses, etc		
PHYSICAL FITNESS GEAR (as required)		
Grey Sports T-Shirt and Shorts		
Running Shoes		

Note. Additional comments may be recorded on the back of the checklist.

THIS PAGE INTENTIONALLY LEFT BLANK



**COMMON TRAINING
PROFICIENCY LEVEL FOUR
INSTRUCTIONAL GUIDE**



SECTION 5

EO C408.01 – DISCUSS THE HISTORY OF DRILL

Total Time:

30 min

PREPARATION

PRE-LESSON INSTRUCTIONS

Resources needed for the delivery of this lesson are listed in the lesson specification located in A-CR-CCP-804/PG-001, *Proficiency Level Four Qualification Standard and Plan*, Chapter 4. Specific uses for said resources are identified throughout the instructional guide within the TP for which they are required.

Review the lesson content and become familiar with the material prior to delivering the lesson.

Photocopy the Summary of Significant Drill Events handout located at Attachment A for each cadet.

PRE-LESSON ASSIGNMENT

Nil.

APPROACH

An interactive lecture was chosen for this lesson to orient the cadets to the history of drill and generate interest in the subject.

INTRODUCTION

REVIEW

Nil.

OBJECTIVES

By the end of this lesson the cadet shall have discussed the history of drill.

IMPORTANCE

It is important for cadets to discuss the history of drill as it represents a part of military history. Being able to understand the purpose and evolution of drill will help cadets understand why drill movements are performed by the military today.

Teaching Point 1**Discuss the origins of drill.**

Time: 10 min

Method: Interactive Lecture



This TP is intended to introduce the origin of drill throughout ancient history and how vital drill used was on the battlefield.

Distribute the Summary of Significant Drill Events located at Attachment A to each cadet.

In ancient history, the most powerful, efficient and developed empires developed ways of moving soldiers from one place to another on the battlefield, without individuals getting confused and mixed up with other units. Empires realized that well-drilled soldiers were more efficient in battle.



The earliest known drill movement, during the rise of kingship in Mesopotamia, about 3000 BC, was close-order drill, defined as shoulder to shoulder marching.

At one time, drill and tactics were the same, as drill was needed on the battlefield. Battle drill has existed since ancient times. Separate drill for infantry, armoured, cavalry and others were replaced by all arms drill early in the 20th century, as the changing conditions of war gradually separated tactics from barrack routine.



Infantry. Infantry drill was practiced regularly around 1000 BC and was necessary to ensure that each soldier's movements matched those of the rest.

Armoured. Soldiers, known as armoured spearmen, fought in close-order drill and marched in step to maintain an unbroken shield wall against the enemy. Regular practice was needed to keep the ranks together during battle.

Cavalry. In 875 BC, about a century after the infantry and armoured were developed, a new battlefield tactic (the bow and arrow) was introduced and a new style of warfare drill developed, which resulted in the establishment of the Cavalry. The Cavalry could attack from a distance, with the use of horses. They learned to do drill on the horses, control the horses and aim and shoot their bow and arrow.

Imitation of battle taught the proper use of weapons and strengthened endurance on the battlefield. Armies found that by teaching the soldiers drill and battle procedures, their chances of victory significantly improved.

Drill is still used routinely to move soldiers in an orderly and efficient manner. It also forms the basis of the precise manoeuvres used in military displays and ceremonies.

Romans

Around 2400 BC, Romans realized the way to learn the required skills when deploying for battle was by training Roman soldiers to execute drill in formation. At the beginning of training, recruits were taught the military pace by marching quickly, in time and in formation, up to 32 km (20 miles) a day. Three times a month, garrison soldiers marched 16.1 km (10 miles), built a fortified camp and returned to base, all in the same day. Individual skills with weapons were also developed with daily practice.

Romans spent most of their time practicing ceremonial guard duty and drill, in order to become well-drilled soldiers. The emotional significance of daily and prolonged close-order drill created a lively esprit de corps among the poverty-stricken peasant recruits and the urban outcasts.

The Romans are presumed to have used cadence while marching for tactical formations. Romans regarded military music quite seriously, as they had several warlike instruments. Each soldier had a trumpet, a horn, or both. These were employed for signals, or what is now referred to as “calls”. Instruments were used for marching music and to direct the movement of soldiers.



As Roman soldiers clashed with other armies, they would learn and employ the same sort of successful drill that the other armies had developed.

Greeks and Spartans

Greek citizens did not willingly accept the rigors of military drill, but the emotional effects of keeping together did not disappear when citizen soldiers ceased to dominate military affairs. Drill became more elaborate in the fourth century BC, as those who participated in drill were professional soldiers whose loyalties were to their commanders.

Spartans engaged in drill and marching exercises on a regular basis and learned how to advance evenly into battle by keeping in step to the sound of music, all without breaking their order or ranks. Spartans also learned how to execute flanking movements and open and close order march, allowing their armies to alter the length of their front.



A Spartan is a citizen of Sparta (city in the South Peloponnese) in ancient Greece.



Spartans developed rigorous styles of military training as they required youth to live apart from family, according to their age class in order to participate in physical exercises and military drill.

Chinese

Chinese armies used drummers to beat the drums while soldiers were marching. The drummers would beat the drums once to signify the left foot moving forward and then beat it again to signify the right foot moving forward.

When drill and combat methods were taught, they were taught to 100 men at a time. After instruction to 100 men was complete, they were united with other companies which were comprised of 1 000 men. When the instruction to the 1 000 men was complete, they were combined with other regiments.

Large infantry armies were taught to handle their weapons in unison and maintain formation by keeping in step on the battlefield, all by responding to signals. Most of China's drill movements between 400 and 300 BC were derived from the Romans and the Greeks.



If a drummer missed a beat, he was executed. Those that moved by themselves or did not obey the drums or signals were also executed.

CONFIRMATION OF TEACHING POINT 1

QUESTIONS:

- Q1. In ancient history, why did empires develop ways of moving organized soldiers from one place to another?
- Q2. At the beginning of training, how were Roman recruits taught military pace?
- Q3. Why did Chinese armies use drums?

ANTICIPATED ANSWERS:

- A1. In ancient history, the most powerful, efficient and developed empires developed ways of moving soldiers from one place to another on the battlefield, without individuals getting confused and mixed up with other units.
- A2. At the beginning of training, Roman recruits were taught military pace by marching quickly, in time and in formation, up to 32 km (20 miles) a day.
- A3. Chinese armies used drummers to beat the drums when soldiers were marching. The drummers would beat the drum once to signify the left foot moving forward and then beat it again to signify the right foot moving forward.

Teaching Point 2

Discuss the evolution of drill movements.

Time: 15 min

Method: Interactive Lecture



This TP is intended to describe the evolution of drill and how drill movements and instruction developed throughout the years.

Infantry supremacy and precise drills were eclipsed after the fall of the Roman Empire. During the feudal era, mounted knights ruled combat. Infantry drills were resurrected in the 14th century and slowly developed and improved thereafter.

Swiss

Disciplined soldiers marched in cadence to the sound of musical instruments in admirable order beneath their banners. It is believed that the Swiss, in the late 1300s, were the first modern soldiers to march to music.

Dutch

Words of command were starting to be used for drill shortly after it was introduced to the Dutch in the late 1500s. It became possible to get soldiers to move in unison while performing the actions needed to load, aim and fire their weapons. The soldiers practiced until the necessary motions were almost automatic. This made them less likely to be disrupted by the stress of battle, an advantage when meeting untrained soldiers.

Words of command permitted companies, platoons and squads to respond to their designated leader as different movements and commands were established for units of every size. Soldiers had to practice these movements whenever possible. It was determined that when an entire army was trained this way, control of battle became possible.

In the early 1600s, an artist was used to make engravings of each posture required for each drill movement, with the corresponding words of command below each picture. This material was then gathered and published into a book.

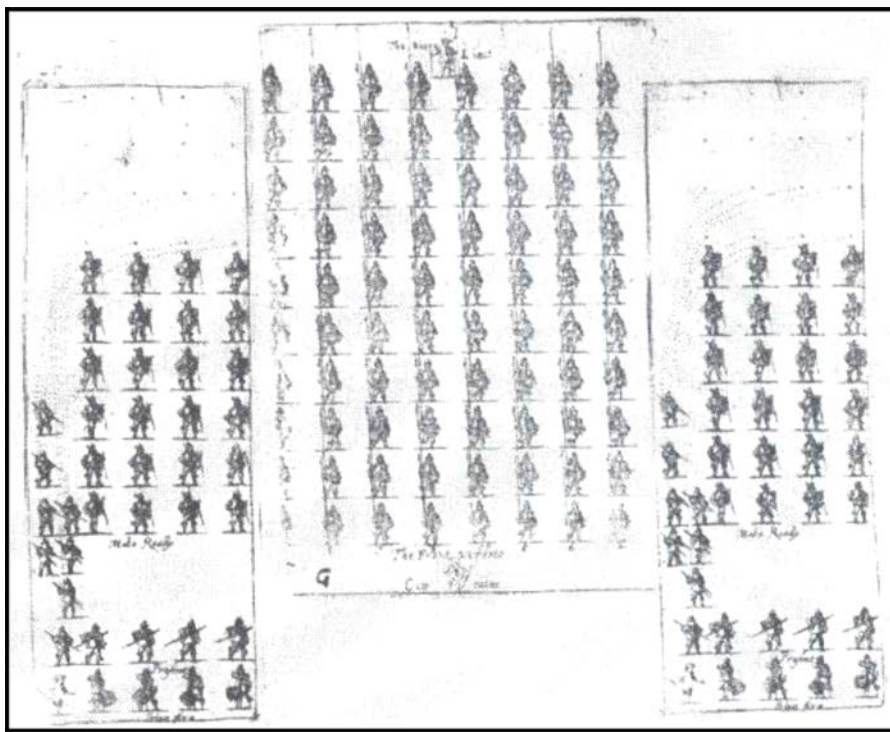

Figure 1 Diagram of a Drill Movement in the 1600s

Note. From *Keeping Together in Time: Dance and Drill in Human History* (p. 86), W. H. McNeill, 1997, Cambridge, MA: Harvard University Press. Copyright 1995 by William H. McNeill.



Over the next half century, the Germans, Russians, Spaniards and French translated the book, causing these drill movements to spread across Europe.

Germans

In the mid 1800s, the Germans (and the Swiss) had the idea of having soldiers become instructors. This provided the opportunity to break down the drill movement(s), demonstrating for all soldiers to see and by allowing the leaders to call out the movements, "by the numbers".



In the late 1800s, the British, Japanese and Chinese followed the Germans and the Swiss by having soldiers teach drill movements.

British

In the British Army, the balance step was a feature of the ordinary march step, experienced today as the slow march. The balance step was introduced as soldiers were required to manoeuvre shoulder to shoulder over rough and uneven ground in disciplined ranks, while giving effective volley fire. Each recruit was trained as a member of a squad until perfect in all points of duty. Each soldier was allowed to join the battalion after being fully trained. Every soldier, after returning from a long absence, had to be re-drilled before being permitted to act in the ranks of his company.

It was imperative that commanders were able to estimate the time required for soldiers to march from point A to point B on foot. With that in mind, the following marches were introduced to the British Army in 1824:

- **March (75 steps per minute, each step 30 inches [76 cm]).** The slowest step (otherwise known as slow time) at which soldiers moved. This march was most commonly used for parades or moving very large formations.
- **Quick march (108 steps per minute, each step 30 inches [76 cm]).** This ordinary pace was applied to most movements by large bodies of soldiers.
- **Wheeling step (120 steps per minute, each step 30 inches [76 cm]).** Wheeling (forming) from line into column or vice versa, ensured there was no delay in achieving the required formation to face a new enemy.
- **Double march (150 steps per minute, each step 36 inches [91 cm]).** This march was applied to the movements within the divisions within a battalion without exhausting soldiers in heavy marching order (eg, load carrying equipment). In rank movements, the double march, when safely applied, may be used in rapid formations, or for quickly moving ranks.

Canadian

- **Royal Canadian Navy.** The Royal Canadian Navy used army drill and ceremonial procedures when on solid ground, by parading as platoons, companies and battalions. While on a ship, the navy conducted ship board drill. The navy still uses the same drill movements while on solid ground; however, they parade by divisions.
- **Canadian Army.** With few exceptions, Canada's Armed Forces used British drill manuals (sometimes with just a Canadian cover and covering page) up until the end of World War II (WW II). It was only with the introduction of a new family of small arms weapons (1989 Draft Drill Manual), and similar developments in other Commonwealth countries, that some of the old drill movements diverged. There were still many similarities in drill, allowing Canadian regiments to execute drill alongside British Army personnel.

One strong influence on the Canadian Forces is the evolution to independent statehood within the British Commonwealth of Nations. This can be seen in customs and routine, uniforms and drill, organization and many other matters (eg, trooping the colours, gun salutes).

- **Royal Canadian Air Force.** Technical requirements of the Royal Canadian Air Force in 1941 called for speeding up the process of drill instruction and, at the same time, reducing the periods of practical training. Both of these objectives were attained by properly combining classroom instruction and parade ground training. The daily program of training was arranged to allow all personnel on strength to receive one hour of classroom instruction and parade ground training per week.

In 1955, the classroom explanation was absent from the *Manual of Drill for the Royal Canadian Air Force*. When conducting drill training, the Royal Canadian Air Force used army drill and ceremonial procedures.



Instructional and practical drill training periods for the Royal Canadian Air Force were as follows:

- classroom instruction—45 percent (demonstration and explanation by instructor);
- practical training—25 percent (on the parade ground);
- mutual instruction—15 percent; and
- voice training—15 percent.



The foot and arms drill of the Royal Canadian Navy, Canadian Army and Royal Canadian Air Force were generally similar, being derived from the same tactical practices. When the three services were unified in 1968, evolution continued by blending the drill detail back into one standard of drill.

CONFIRMATION OF TEACHING POINT 2

QUESTIONS:

- Q1. What did the Dutch create in the early 1600s?
- Q2. What were the marches introduced by the British in 1824?
- Q3. Whose drill manuals did the Canadian Armed Forces use before World War II?

ANTICIPATED ANSWERS:

- A1. In the early 1600s, the Dutch created a book of drill. An artist was used to make engravings of each posture required of each drill movement, with the corresponding words of command below each picture. This material was then gathered and published into a book.
- A2. The following marches were introduced by the British Army in 1824:
- march,
 - quick march,
 - wheeling step, and
 - double march.
- A3. With few exceptions Canada's Armed Forces used British Manuals (sometimes just with a Canadian cover and covering page) up until the end of WW II.

END OF LESSON CONFIRMATION

QUESTIONS:

- Q1. How did the Chinese teach drill to large numbers of soldiers?
- Q2. When did the Dutch start using words of command for drill?
- Q3. Why did the British introduce the balance step?

ANTICIPATED ANSWERS:

- A1. When drill and combat methods were taught, they were taught to 100 men at a time. After instruction to 100 men was complete, they were united with other companies which were comprised of 1 000 men. When the instruction to the 1 000 men was complete, they were combined with other regiments.
- A2. The Dutch started using words of command for drill in the late 1500s.
- A3. The British introduced the balance step because the soldiers were required to manoeuvre shoulder to shoulder over rough and uneven ground in disciplined ranks, while giving effective volley fire.

CONCLUSION

HOMEWORK / READING / PRACTICE

Nil.

METHOD OF EVALUATION

Nil.

CLOSING STATEMENT

Drill procedures and movements are a large component of today's military. Learning about the purpose and evolution of drill will help you understand why so many drill movements are performed within the military today.

INSTRUCTOR NOTES / REMARKS

Nil.

REFERENCES

A0-002 A-PD-201-000/PT-000 Director of History and Heritage 3-2. (2005). *The Canadian Forces manual of drill and ceremonial*. Ottawa, ON: Department of National Defence.

C2-249 ISBN 978-0674-5023-07 McNeill, W. (1997). *Keeping together in time: Dance and drill in human history*. Cambridge, MA: Harvard University Press.

SUMMARY OF SIGNIFICANT DRILL EVENTS

Date	People	Event
3000 BC	Mesopotamians	The earliest known drill movement was close-order drill (defined as shoulder to shoulder marching).
2400 BC	Romans	Realized the way to learn the required skills when deploying for battle was by training soldiers drill in formation.
1000 BC	Greeks / Romans	Infantry drill was practiced regularly and was very necessary to ensure that each soldier's movements matched those of the rest. Armoured soldiers, also known as spearmen, fought in close-order drill and marched in step to maintain an unbroken shield wall.
875 BC	Greeks / Romans	A new battlefield tactic (the bow and arrow) was introduced and a new style of warfare drill developed, which resulted in the establishment of the Cavalry. The Cavalry could attack from a distance, with the use of horses. They learned to do drill on the horses, control the horses and to aim and shoot their bow and arrow.
400 and 300 BC	Chinese	Most of China's drill movements were derived from the Romans and Greeks.
1300s	Swiss	Were the first modern soldiers to march to music.
1500s	Dutch	The first to use words of command for drill.
1600s	Dutch	An artist made engravings of each posture required for each drill movement, with the corresponding words of command below each picture. This material was gathered and published into a book.
mid 1800s	Germans (and Swiss)	Had the idea of having soldiers become instructors. This provided the opportunity to break down the drill movement(s), demonstrating for all soldiers to see and by allowing the leaders to call out the movements, "by the numbers".
late 1800s	British, Japanese and Chinese	Followed the Germans and the Swiss by having soldiers teach drill movements.
1824	British	The balance step (the slow march) was introduced as soldiers were required to manoeuvre shoulder to shoulder over rough and uneven ground in disciplined ranks, while giving effective volley fire.
early 1900s	Canadians	Canada's Armed Forces used British drill manuals (sometimes with just a Canadian cover and covering page).
1941	Canadians	Technical requirements of the Royal Canadian Air Force called for speeding up the process of drill instruction and, at the same time, reducing the periods of practical training.
1955	Canadians	The classroom explanation was absent from the <i>Manual of Drill for the Royal Canadian Air Force</i> .
1968	Canadians	The foot and arms drill of the Royal Canadian Navy, Canadian Army and Royal Canadian Air Force were generally similar, being derived from the same tactical practices. When the three services were unified in 1968, drill evolution continued by blending the drill detail back into one.

THIS PAGE INTENTIONALLY LEFT BLANK



**COMMON TRAINING
PROFICIENCY LEVEL FOUR
INSTRUCTIONAL GUIDE**



SECTION 6

EO C408.02 – VIEW A RE-ENACTMENT THAT DEMONSTRATES THE HISTORY OF DRILL

Total Time:

90 min

THERE IS NO INSTRUCTIONAL GUIDE PROVIDED FOR THIS EO

THIS PAGE INTENTIONALLY LEFT BLANK



**COMMON TRAINING
PROFICIENCY LEVEL FOUR
INSTRUCTIONAL GUIDE**



SECTION 1

EO M409.01 – IDENTIFY METHODS OF INSTRUCTION

Total Time:

60 min

PREPARATION

PRE-LESSON INSTRUCTIONS

Resources needed for the delivery of this lesson are listed in the lesson specification located in A-CR-CCP-804/PG-001, *Proficiency Level Four Qualification Standard and Plan*, Chapter 4. Specific uses for said resources are identified throughout the instructional guide within the TP for which they are required.

Review the lesson content and become familiar with the material prior to delivering the lesson.

Create a slide of Attachment A.

Photocopy and 3-hole punch the handouts located at Attachments B, F, G, and H for each cadet.

Make three copies of the Methods of Instruction Puzzle located at Attachment C for the activity in TP1 on two different colours of paper. Description sheets should be colour A and Typical Application sheets should be colour B.

Prepare the Methods of Instruction Puzzles using the directions located at Attachment C.

Make one photocopy of the methods of instruction information sheets located at Attachment E.

Provide binders for each cadet to collect all work in this performance objective.

PRE-LESSON ASSIGNMENT

Nil.

APPROACH

An in-class activity was chosen for TPs 1 and 2 as it is an interactive way to review previously learned material and confirm the cadets' comprehension of new methods of instruction.

A group discussion was chosen for TP 3 as it allows the cadets to interact with their peers and share their knowledge, experiences, opinions and feelings about the application of various methods of instruction.

INTRODUCTION

REVIEW

Nil.

OBJECTIVES

By the end of this lesson the cadet shall be expected to identify the methods of instruction and select the appropriate method of instruction for a given topic.

IMPORTANCE

It is important for cadets to be aware of the various methods of instruction when filling an instructional role. Being able to select and apply each method will help the cadets prepare and deliver an effective lesson.

Teaching Point 1**Conduct an activity where the cadets will review methods of instruction.**

Time: 10 min

Method: In-Class Activity

ACTIVITY**OBJECTIVE**

The objective of this activity is to review the methods of instruction previously taught in EO M309.02 (Identify Methods of Instruction).

RESOURCES

- Teaching = learning handout located at Attachment A,
- Methods of Instruction worksheet located at Attachment B,
- Methods of Instruction Puzzle located at Attachment C,
- Methods of Instruction Guide Attachment D (for instructor use only),
- OHP (if required),
- Envelopes,
- Binders,
- Pens / pencils,
- Tape, and
- Stopwatch.

ACTIVITY LAYOUT

Place the sample Methods of Instruction Puzzle (located at Attachment C) at the front of the classroom so it is easily accessible to all groups.

Set up two work stations and place the following at each station:

- Methods of Instruction worksheet located at Attachment B for each cadet,
- One envelope with the Method of Instruction Puzzle located at Attachment C, and
- One binder for each cadet.

ACTIVITY INSTRUCTIONS

1. Divide the cadets into two groups.
2. Show the cadets the slide of Attachment A and ask the cadets to:
 - a. determine what the cartoon is implying; and
 - b. consider why varying teaching techniques can assist with learning.

3. Introduce the sample Methods of Instruction Puzzle by:
 - a. pointing out the two top row categories: description and typical applications;
 - b. identifying the first column as the six methods of instruction; and
 - c. explaining the colour coding system by pointing out that all descriptions are colour A and all typical applications are colour B.
4. Have the groups race to complete the Methods of Instruction Puzzle, according to the following rules:
 - a. Groups must place their pieces of the puzzle in the appropriate column and row.
 - b. A group that is having difficulty may visit the sample located at the front of the classroom up to two times.
 - c. A penalty of 30 seconds will be added to a group's time for each visit to the sample.
 - d. The group that completes the puzzle correctly in the least time is the winner.



Attachment B is provided for the cadets who finish the puzzle early. Ask them to make personal notes on each method of instruction. It is not necessary to fully complete the sheet but it will be a useful reference in the future.

SAFETY

Nil.

CONFIRMATION OF TEACHING POINT 1

The cadets' participation in the activity will serve as the confirmation of this TP.

Teaching Point 2

Conduct an activity where the cadets will describe methods of instruction.

Time: 20 min

Method: In-Class Activity

ACTIVITY

OBJECTIVE

The objective of this activity is to introduce the cadets to methods of instruction.

RESOURCES

- Methods of instruction information sheets located at Attachment E,
- Methods worksheet located at Attachment F,
- Presentation aids,
- Markers,

- Pens / pencils, and
- Tape.

ACTIVITY LAYOUT

Set up six learning stations, to include:

- Flip chart paper,
- Markers, and
- Pens / pencils.

ACTIVITY INSTRUCTIONS

1. Write the following on the whiteboard / flip chart:
"Tell me, and I forget;
Show me, I may remember;
Involve me, and I will understand." - Chinese Proverb
2. Ask the cadets the following questions:
 - a. What are some possible meanings of the quote?
 - b. What are the connections between learning and instruction?
3. Divide the class into six groups and assign each group a method of instruction, to include:
 - a. group discussion,
 - b. guided discussion,
 - c. role-play,
 - d. experiential learning,
 - e. problem-based learning, and
 - f. case study.



If the class size is small, divide the class into three groups and assign two methods to each group.

4. Have the groups title the flip chart paper with their given method of instruction.
5. Have the cadets write the following headings on the flip chart paper:
 - a. description,
 - b. applications,
 - c. preparation and development, and
 - d. pros and cons.

6. Have each group brainstorm and record ideas relating to each section of their flip chart paper.
7. Distribute the assigned method of instruction information sheet to each group.
8. Have each group read their method of instruction information sheet and add details to their flip chart paper.



Distribute the Methods worksheet to each cadet.

9. Display charts around the room.
10. Have each group present their method of instruction. Allocate about 1–2 minutes for each group presentation.
11. Instruct the cadets to fill in the Method worksheet, making short notes, as each group presents their method to the class.



It is not necessary for the cadets to fully complete the sheet but it will be a useful reference in the future.

SAFETY

Nil.

CONFIRMATION OF TEACHING POINT 2

The cadets' participation in the activity will serve as the confirmation of this TP.

Teaching Point 3

Conduct a group discussion on the application of methods of instruction.

Time: 20 min

Method: Group Discussion

BACKGROUND KNOWLEDGE



The point of the group discussion is to draw the following information from the group using the tips for answering / facilitating discussion and the suggested questions provided.

Some examples of the types of lessons that lend themselves easily to a specific method of instruction are:

Interactive Lecture. Lessons with facts or dates, including history lessons.

Demonstration and performance. Any drill or skill, such as first aid and rope work.

In-class activity. Lessons that lend themselves easily to using brainstorming, worksheets and group work. This type of lesson is used to reinforce instructional topics such as instructional technique and environmental stewardship.

Practical activity. Map and compass, and cool-down and warm-up activities for sports.

Game. Lessons that include labelling or defining terms and performance-based lessons.

Field trip. Visit an elemental museum, visit an airport or ship, and visit a college to view possible careers.

Group discussion. Benefits of healthy living, qualities of a good leader and environmental issues relevant to Canada.

Guided discussion. Explain personal integrity and explain decision-making processes.

Role-play. Influence behaviours, leadership scenarios, and history.

Experiential learning. Participating in citizenship activities and attending weekend training.

Problem-based learning. Teambuilding activities and leadership styles.

Case study. Characteristics of a leader and various events in history.

GROUP DISCUSSION



TIPS FOR ANSWERING / FACILITATING DISCUSSION:

- Establish ground rules for discussion, eg, everyone should listen respectfully; don't interrupt; only one person speaks at a time; no one's ideas should be made fun of; you can disagree with ideas but not with the person; try to understand others as much as you hope they understand you; etc.
- Sit the group in a circle, making sure all cadets can be seen by everyone else.
- Ask questions that will provoke thought; in other words avoid questions with yes or no answers.
- Manage time by ensuring the cadets stay on topic.
- Listen and respond in a way that indicates you have heard and understood the cadet. This can be done by paraphrasing their ideas.
- Give the cadets time to respond to your questions.
- Ensure every cadet has an opportunity to participate. One option is to go around the group and have each cadet answer the question with a short answer. Cadets must also have the option to pass if they wish.
- Additional questions should be prepared ahead of time.



Attachment G contains a list of possible criteria to consider when choosing methods of instruction. Distribute Attachment G to each cadet before discussing the questions.



Distribute the Method of Instruction Summary handout located at Attachment H. As the methods of instruction are being discussed, the cadets may record ideas for each one on the handout.

To facilitate the discussion, record ideas on a flip chart / whiteboard.

SUGGESTED QUESTIONS:

What methods of instruction do you like to participate in most? Why? Provide an example.

What methods of instruction were used to instruct this lesson? What evidence do you have?

Would you choose a different method of instruction for this lesson? What and why?

What criteria do you consider most / least important when choosing a method of instruction? Why?

Ask the following questions for each method of instruction:

1. What is an application of this method?
2. Why would you choose this method?
3. Does anyone disagree?
4. Would this application apply to another method of instruction? Why or why not?
5. Are there any other lessons that would fall into this method of instruction?



Other questions and answers will develop throughout the group discussion. The group discussion should not be limited to only those suggested.



Reinforce those answers given and comments made during the group discussion, ensuring the teaching point has been covered.

SAFETY

Nil.

CONFIRMATION OF TEACHING POINT 3

The cadets' participation in the group discussion will serve as the confirmation of this TP.

END OF LESSON CONFIRMATION

The cadets' participation in the group discussion will serve as the confirmation of this lesson.

CONCLUSION

HOMEWORK / READING / PRACTICE

Nil.

METHOD OF EVALUATION

This EO is assessed in IAW A-CR-CCP-804/PG-001, *Proficiency Level Four Qualification Standard and Plan*, Chapter 3, Annex B, 409 PC.

CLOSING STATEMENT

It is pertinent to have an exposure to the various methods of instruction in order to be flexible as an instructor. Familiarity with these methods may improve the instructor's ability to select activities that are appropriate for lessons. While many lessons may be taught using more than one method of instruction, choosing the most appropriate method of instruction is key.

INSTRUCTOR NOTES / REMARKS

Nil.

REFERENCES

A0-055 A-P9-050-000/PT-006 Director Training and Education Policy. (2002). *Canadian Forces individual training and education system* (Vol. 6). Ottawa, ON: Department of National Defence.

A0-123 A-PD-050-001-PF-001 Chief of Defence Staff. (2001). *Central flying school flight instructors handbook*. Winnipeg, MB: Department of National Defence.

C0-379 Kizlik, R. (2009). *Education Information for new and future teachers*. Retrieved February 26, 2009 from www.adprima.com

THIS PAGE INTENTIONALLY LEFT BLANK

Teaching = Learning?



Figure A-1 Teaching = Learning

Note: From *Tiger Comics* by Bud Blake. Retrieved March 10, 2009, from <http://www.kingfeatures.com/features/comics/tiger/about.html>

THIS PAGE INTENTIONALLY LEFT BLANK

Name: _____

Place 6 methods of instruction in the circles. Then list two characteristics of each.

Methods of Instruction

	→	
	→	
	→	
	→	
	→	
	→	

THIS PAGE INTENTIONALLY LEFT BLANK

METHODS OF INSTRUCTION PUZZLE

Directions

1. Photocopy three copies of Attachment C using coloured paper.



The top right-hand corner of each page indicates the colour paper to be used for each copy. The colours correspond with different sections of the puzzle as illustrated in Figure C-1.

2. Cut out each piece of the puzzle.
3. Refer to Attachment D to help with the assembly of the puzzle.
4. Assemble one puzzle to demonstrate to the class (as illustrated in Figure C-1).

	Description	Typical Applications
Interactive Lecture	C O L O U R A	C O L O U R B
Demonstration and Performance		
In-Class Activity		
Practical Activity		
Game		
Field Trip		

Figure C-1 Methods of Instruction Puzzle

Note. Created by Director Cadets 3, 2009, Ottawa, ON: Department of National Defence.

5. Put the other two sets of the puzzle pieces in two envelopes.

<p>Interactive Lecture</p>	<p>Demonstration and Performance</p>	<p>In-Class Activity</p>
<p>Practical Activity</p>	<p>Game</p>	<p>Field Trip</p>

DESCRIPTION

TYPICAL APPLICATIONS

DESCRIPTIONS

Colour A

<p>Is used with one or more participants to practice skills, apply strategies, and enhance teams.</p> <p>Supports learning through a challenging activity that allows for skill practice or knowledge confirmation.</p>	<p>A method where theoretical knowledge is reinforced through participation in an activity in a real-life setting.</p>
<p>An instructor-driven method that combines both lecture and interaction to meet lesson objectives.</p> <p>Examples include videos with discussion, games, learning stations, brainstorming, debating, group work and the completion of handouts.</p>	<p>This method involves observing the instructor and performing and rehearsing the task under the supervision of the instructor.</p>

DESCRIPTIONS

<p>Involves a wide variety of potential activity-based learning that can be used to support learning objectives.</p> <p>Encourages participation.</p> <p>Examples include learning stations, videos, brainstorming, debating, group work, and the completion of handouts.</p>	<p>This method includes a wide variety of activity-based learning opportunities that can be used to introduce new experiences.</p>
---	--

Colour A

TYPICAL APPLICATIONS

Colour B

<p>Used to:</p> <ul style="list-style-type: none">• introduce a topic;• discover concepts and principles;• learn terminology;• recall terms;• recognize equipment parts;• carry out an application;• confirm learning; or• demonstrate a process.	<p>Used to:</p> <ul style="list-style-type: none">• introduce / illustrate and confirm topics;• reinforce and clarify classroom learning;• inject variety into the situation; or• allow viewing of operations or equipment that cannot easily be shown in the classroom.
<p>Used to:</p> <ul style="list-style-type: none">• introduce a subject;• present background information;• review previously taught material;• give instructions on procedures; or• illustrate the application of rules, principles or concepts.	<p>Used to:</p> <ul style="list-style-type: none">• teach hands-on operations or procedures;• teach troubleshooting;• illustrate principles;• teach operation or functioning of equipment; or• teach safety procedures.

TYPICAL APPLICATIONS

<p>Used to:</p> <ul style="list-style-type: none">• teach both knowledge and skill lessons;• reinforce instructional objectives;• introduce a subject and generate interest;• give background information;• illustrate application of rules, principles or concepts; or• create interactivity during a lecture.	<p>Used to:</p> <ul style="list-style-type: none">• carry out an application;• demonstrate a process;• verify an explanation;• produce a product;• teach manipulative operations; or• teach procedures.
--	--

Color B

THIS PAGE INTENTIONALLY LEFT BLANK

METHOD OF INSTRUCTION
Interactive Lecture

DESCRIPTION	PRE-LESSON PREPARATION	TYPICAL APPLICATIONS	LESSON DEVELOPMENT
<p>Interactive lecture is an instructor-driven method that combines both lecture and interaction to meet lesson objectives. The lecture portions of the lesson are offset with relevant activities such as videos with discussion, games, learning stations, brainstorming, debating, group work or the completion of handouts.</p>	<p>Use attention-getters such as interesting facts, statistics or rhetorical questions to begin the lecture or to introduce new teaching points.</p> <p>Prepare participatory questions to encourage cadet participation.</p> <p>Prepare evaluative questions for confirmation of teaching points.</p> <p>Obtain or develop training aids to clarify main points.</p> <p>Prepare an in-class activity to avoid lecturing too long.</p> <p>Practice delivering the material.</p>	<p>Interactive lectures can be used with different sizes of groups to:</p> <ul style="list-style-type: none"> • introduce a subject; • present background information; • review previously taught material; • give instructions on procedures; • illustrate the application of rules, principles or concepts; or • introduce a demonstration, discussion or performance. 	<p>Begin the lesson and each new TP with an attention-getter.</p> <p>Use presentation aids such as:</p> <ul style="list-style-type: none"> • flip chart, • whiteboard, and / or • electronic media. <p>Pay attention to signals of alertness, such as:</p> <ul style="list-style-type: none"> • cadets' facial expressions, and • cadets' body language. <p>Deal with alertness problems by:</p> <ul style="list-style-type: none"> • asking for questions; and • posing questions to the group. <p>Use visual training aids at opportune moments.</p> <p>Integrate interesting facts with lesson material to maintain interest.</p> <p>Use participatory questions or a short activity to avoid lecturing too long.</p> <p>Use questions to confirm each teaching point.</p> <p>Confirm the lesson using questions or an activity.</p>

METHOD OF INSTRUCTION
Demonstration and Performance

DESCRIPTION	PRE-LESSON PREPARATION	TYPICAL APPLICATIONS	LESSON DEVELOPMENT
<p>Demonstration and Performance During demonstration and performance, the cadets observe the instructor performing the task in a demonstration, and rehearse it under the supervision of the instructor.</p> <p>Demonstration Method A method of instruction where the instructor, by actually performing an operation or doing a job, shows the cadet what to do, how to do it and explains why, where and when it is done.</p> <p>Performance Method A method in which the cadet is required to perform, under controlled conditions, the operations, skill or movement being taught.</p>	<p>The instructor must be skilled in the task.</p> <p>Gather all materials necessary to instruct the lesson.</p> <p>Break the task down into smaller sequential steps.</p> <p>Practice the lesson to ensure that steps are accurate and clear.</p> <p>Prepare a handout outlining the steps, if necessary.</p> <p>Organize the training area so that all cadets can:</p> <ul style="list-style-type: none"> • see the demonstration, and • perform the task. 	<p>Demonstration Method Demonstration can be used to:</p> <ul style="list-style-type: none"> • teach hands-on operations or procedures; • teach troubleshooting; • illustrate principles; • teach operation or functioning of equipment; • set standards of workmanship; • explain a theory or concept; or • teach safety procedures. <p>Performance Method Performance can be used to:</p> <ul style="list-style-type: none"> • teach hands-on operations or procedures; • teach operation or functioning of equipment; • teach skills; or • teach safety procedures. 	<p>Introduce the lesson by demonstrating what the cadets will be able to do at the end.</p> <p>Explain where the skill can be applied and why it is important.</p> <p>Provide a handout outlining the steps if the process is complex.</p> <p>Explain and demonstrate each step in a sequence.</p> <p>Allow cadets maximum time to practice the steps as soon as possible.</p> <p>Positively reinforce everything the cadets do correctly.</p> <p>Supervise the cadets as they practice, providing assistance or re-demonstrations when necessary.</p> <p>Have cadets perform the skill as confirmation.</p> <p>Encourage the cadets to practice beyond class time.</p>

METHOD OF INSTRUCTION
In-Class Activity

DESCRIPTION	PRE-LESSON PREPARATION	TYPICAL APPLICATIONS	LESSON DEVELOPMENT
<p>In-class activities encompass a wide variety of activity-based learning opportunities that can be used to reinforce and practice instructional topics or to introduce cadets to new experiences. In-class activities should stimulate interest among cadets and encourage their participation, while maintaining relevance to the performance objectives. Examples of in-class activities include learning stations, videos, brainstorming, debating, and group work.</p>	<p>Create an activity that involves all cadets, which can be conducted within the time allocated.</p> <p>Clearly specify the objective of the activity.</p> <p>Obtain all materials necessary to complete the activity.</p> <p>Write out specific instructions describing what participants are supposed to do.</p> <p>Write out specific directions for conducting the activity.</p> <p>Arrange for assisting staff, if necessary, to help conduct the activity.</p> <p>Prepare handouts for cadets containing background information.</p> <p>Organize the training area into work / learning stations.</p>	<p>An in-class activity can be used for both knowledge and skill lessons to:</p> <ul style="list-style-type: none"> • reinforce instructional objectives; • introduce a subject and generate interest; • present background information; • give direction on procedures; • introduce a demonstration, discussion or performance; • illustrate the application of rules, principles or concepts; • create interactivity during a lecture; or • review, clarify or summarize information. 	<p>Introduce the activity to the whole group.</p> <p>Brief participants on what will be expected of them.</p> <p>Stress timings.</p> <p>Ensure all resources are available.</p> <p>Begin the activity.</p> <p>Supervise and assist the groups as required.</p> <p>Conclude the activity.</p> <p>Confirm the TP or lesson.</p> <p>Debrief the cadets.</p>

METHOD OF INSTRUCTION
Practical Activity

DESCRIPTION	PRE-LESSON PREPARATION	TYPICAL APPLICATIONS	LESSON DEVELOPMENT
<p>Practical activities encompass a wide variety of activity-based learning opportunities that can be used to reinforce and practice skills or to introduce cadets to new experiences. Practical activities should stimulate interest among cadets and encourage their participation, while maintaining relevance to the performance objective.</p>	<p>The instructor must be skilled in the task.</p> <p>Gather all materials necessary to instruct the lesson.</p> <p>Organize the training area so that all cadets will have space to perform the task safely.</p> <p>Ensure there is enough time to conduct the complete activity or breakdown the task into smaller stages.</p> <p>Prepare a handout outlining the steps, if necessary.</p> <p>Arrange for assisting staff, if necessary.</p> <p>Plan for composition of groups.</p>	<p>If it is used to teach new material, it must be combined with other methods to ensure cadets have the necessary background information to complete the activity.</p> <p>The practical activity method can be used to:</p> <ul style="list-style-type: none"> • carry out an application; • demonstrate a process; • verify an explanation; • produce a product; • introduce a subject; • teach manipulative operations; • teach procedures; • teach troubleshooting; • illustrate principles; • teach equipment operation; or • teach safety. 	<p>Review background information.</p> <p>Distribute the handout, if necessary.</p> <p>Introduce the activity to the group.</p> <p>Stress safety.</p> <p>Brief the cadets on what they will be expected to do.</p> <p>Brief assisting staff on what they will be expected to do.</p> <p>Begin the activity.</p> <p>Supervise the cadets and provide assistance, if necessary.</p> <p>Watch for safety infractions and stop the activity, if necessary.</p> <p>Conclude the activity.</p> <p>Debrief the cadets.</p>

METHOD OF INSTRUCTION

Game

DESCRIPTION	PRE-LESSON PREPARATION	TYPICAL APPLICATIONS	LESSON DEVELOPMENT
<p>Games are used with one or more participants to practice skills, apply strategies and enhance teams. It is critical that the game supports learning through a challenging activity that allows for skill practice or knowledge confirmation.</p>	<p>Develop a simple game with the following characteristics:</p> <ul style="list-style-type: none"> • is fast to play; • is easy and quick to organize; • has few rules; • uses minimal equipment; and • involves maximum participation. <p>If possible, use variations of games cadets know from childhood or television.</p> <p>Determine the following when developing the rules of the game:</p> <ul style="list-style-type: none"> • individual or team play, • how to change leaders, • what the leader will do, • what the followers will do, • timings for the game, • how to signal the start and stop of the game, • how to ensure safety. <p>Obtain the resources needed to play the game.</p> <p>Organize the training area to play the game.</p>	<p>Games create variety and arouse interest but must also support learning.</p> <p>Games can be used to:</p> <ul style="list-style-type: none"> • introduce a topic; • discover concepts and principles; • learn terminology; • recall terms; • recognize equipment parts; • develop strategies and tactics; • carry out an application; • demonstrate a process; • practice interpersonal skills; and / or • confirm learning. 	<p>Brief the cadets on the following:</p> <ul style="list-style-type: none"> • the objective of the game, and • rules of the game. <p>Play the game.</p> <p>Supervise closely to :</p> <ul style="list-style-type: none"> • ensure that the game is played in the manner expected; • ensure that the game is played safely; and • ensure maximum participation. <p>End the game.</p> <p>Debrief the cadets.</p>

METHOD OF INSTRUCTION
Field Trip

DESCRIPTION	PRE-LESSON PREPARATION	TYPICAL APPLICATIONS	LESSON DEVELOPMENT
<p>Theoretical knowledge is reinforced through participation in an activity in a real-life setting. Prior planning helps to ensure all pre-training and safety standards are met. Field trip activities are planned and carried out to achieve clear instructional objectives that are understood by the cadets. Examples include trips to areas of local interest, flying / gliding, hiking and / or sailing.</p>	<p>Specify the objective(s) of the field trip.</p> <p>Determine the time and location of the field trip.</p> <p>Obtain necessary authorizations.</p> <p>Determine the timings.</p> <p>Determine the activities or demonstrations needed to achieve the objectives.</p> <p>Determine if trained personnel will be available to assist.</p> <p>Arrange the following, if necessary:</p> <ul style="list-style-type: none"> • transportation, • supervision, and • meals. <p>Determine if the cadets will be allowed to use equipment or participate in a training activity.</p> <p>Determine if all cadets can take part at once or if they need to rotate through.</p> <p>Divide the cadets into groups, if necessary.</p> <p>Ensure safety.</p>	<p>The field trip is used to:</p> <ul style="list-style-type: none"> • introduce / illustrate and confirm topics; • reinforce and clarify classroom learning; • inject variety into the training situation; or • allow cadets to view operations or equipment that cannot easily be shown in the classroom. 	<p>Inform cadets as soon as possible of the following:</p> <ul style="list-style-type: none"> • time of the field trip, • location of the field trip, and • timings for departure. <p>Brief cadets on the following prior to departure:</p> <ul style="list-style-type: none"> • objectives of the field trip, • timings and groupings for activities and demonstrations, and • how they will participate during the field trip. <p>During the field trip ensure the following:</p> <ul style="list-style-type: none"> • the safety of all cadets, • maximum participation, and • the objectives are met. <p>After the field trip:</p> <ul style="list-style-type: none"> • debrief the cadets; and • confirm that objectives have been met. <p>Express appreciation to the facilitators of the field trip.</p>

Guided Discussion

Description:

A method in which learners are guided in steps to reach instructional objectives by drawing out their opinions, knowledge, experience and capabilities, and by building on these to explore and develop new material. Learners discuss issues to expand their knowledge of the subject.

Applications:

- Develop imaginative solutions to problems (eg, through brainstorming).
- Stimulate thinking and interest and secure learner participation.
- Emphasize main teaching points.
- Supplement lectures, reading or laboratory exercises.
- Determine how well learners understand concepts and principles.
- Prepare learners to apply theory or procedure.
- Clarify or review points.
- Determine learner progress and the effectiveness of prior instruction.
- Foster attitudinal change.

Preparation and Development:

Reading material should be provided to learners in advance so that learners are familiar with the concepts that will be discussed.

To begin, an instructor should introduce the topic and scenario; outline the main discussion points; state the what, where and why of the lesson; and create an open environment.

During the body of the lesson, the instructor poses open lead-off questions to guide the discussion toward the aim. The instructor concludes the lesson by reviewing all the main points contributed by both the learner and instructor and by relating points back to the lesson aim.

Advantages:

- Increases cadet interest.
- Increases cadet acceptance and commitment.
- Uses cadet knowledge and experience.
- Results in more permanent learning because of the high degree of cadet participation.

Disadvantages:

- Requires highly skilled instructors to redirect discussion using rephrased comments or summaries.
- Requires preparation by cadets.
- Limits content.
- Consumes time.
- May not accomplish goals.
- Can get off topic.
- Some members may not participate.

Group Discussion

Description:

A method to discuss issues and share knowledge, opinions and feelings about a topic in small groups. The instructor's questioning is flexible and minimal, and encourages reflection on personal experiences and opinions through peer interactions.

Applications:

- Develops imaginative solutions to problems.
- Emphasizes main teaching points.
- Determines individual progress and the effectiveness of prior instruction.
- Prepares individuals for application of theory or procedure.

Preparation and Development:

Prepare an issue or problem that will interest the cadets and stimulate discussion.

Organize cadets into small groups.

Put groups in circles or horseshoes.

Pose a lead-off question and encourage participation of all cadets.

Advantages:

- Increases cadet interest.
- Increases cadet acceptance and commitment.
- Uses cadet knowledge and experience.
- Results in more permanent learning because of the high degree of cadet participation.

Disadvantages:

- Requires highly skilled instructors.
- Requires preparation by cadets.
- Limits content.
- Consumes time.
- Restricts size of group.
- Requires selective group composition.

Problem-Based Learning	
<p>Description: A method that facilitates the learning of principles and concepts by having learners work on solving a problem drawn from the work environment. Instructors must pose thought-provoking questions and guide cadets without influencing their decisions.</p>	
<p>Applications: It allows learners to:</p> <ul style="list-style-type: none"> • learn through practicing what they will have to do on the job; • learn by imitating others' behaviour; • learn from the feedback of others; and • learn through practice and reflection on each scenario in which they participate. 	
<p>Preparation and Development: This method is usually conducted with small groups of 5–7 learners or with pre-established teams. Instructors prepare carefully constructed problems that are realistic. During the lesson, learners analyze the problem and work toward solving it. Instructors facilitate learning by posing questions to get learners thinking and talking (eg, What are the clues, facts and any guesses about the problem and its causes? What other information is needed?). The instructor should ensure that all learners participate because discussion is key to learning, but they should try not to influence decisions. Instructors may also challenge learners' thinking by questioning learners without leading them to the correct answer (eg, What does this mean? What are the implications?).</p>	
<p>Advantages:</p> <ul style="list-style-type: none"> • Encourages participation by cadets. • Maintains relevance to performance objectives. • Many resources are involved. • Problems are realistic for learners to relate to. 	<p>Disadvantages:</p> <ul style="list-style-type: none"> • Critical thinking skills are required. • Broad knowledge of the subject matter is required. • Instructors must be experienced in facilitating learning.

Role-Play

Description:

A method of interaction in which learners play out and practice realistic behaviors by assuming specific roles and circumstances.

Applications:

It allows learners to:

- practice responding to various situations that are similar to those they will encounter; and
- develop human interaction skills.

Preparation and Development:

Begin the lesson by clearly explaining the objective of the lesson (what, where, when and why). It is critical to explain that role-playing is a learning process and learners are not expected to play their roles perfectly from the start. This will help put learners at ease.

The instructor must clearly explain each role the learners will play. This is followed by a demonstration of the role-play either on video or through a live performance by instructional staff. Learners are paired or grouped together and the role-plays are cycled through. The instructor does not interfere during the role-play unless learners veer off topic, require cues or assistance, or a safety issue arises. Following each role-play, the instructor debriefs the learner on their performance. Correct behaviours should be positively reinforced, and areas requiring improvement identified.

Advantages:

- High participation, interactive delivery.
- May lead to discussions.
- Experience is developed in a supportive environment.
- Can be very versatile depending on the topic.

Disadvantages:

- Participants can be easily sidetracked.
- Needs a lot of preparation and controls must be clarified.
- Competent, experienced and prepared instructors are needed.
- Not always successful due to group composition.

Experiential Learning	
<p>Description: A method using knowledge and skills to meet objectives. There are four stages to this method: concrete experience, reflective observation, abstract conceptualization, and active experimentation.</p>	
<p>Applications: The method teaches:</p> <ul style="list-style-type: none"> • practical skills, • transferable skills, • problem solving, and • process or principle. 	
<p>Preparation and Development: Step 1: Concrete Experience. Individuals have an experience and take time to identify and define it. Step 2: Reflective Observation. Provides time for individuals to reflect on visual, emotional, and cognitive aspects of the experience. Step 3: Abstract Conceptualization. Individuals work to understand and make connections between the experience and prior experiences. Step 4: Active Experimentation. Individuals look ahead to plan the application of skills and knowledge acquired for future experiences.</p>	
<p>Advantages:</p> <ul style="list-style-type: none"> • Knowledge is shared by the participants. • Most participants will create new knowledge. • Everyone is actively involved in the teaching and learning process. • Numerous resources are used. 	<p>Disadvantages:</p> <ul style="list-style-type: none"> • Expensive as it uses many resources. • Requires a lot of planning, preparation and organization prior to the activity. • The instructor must master the subject developed. • May not be a good process for learning details.

Case Study

Description:

A method using a written problem, situation or scenario to achieve a performance objective.

Applications:

- Used for learning principles, attitudes and concepts.
- Develops critical thinking and promotes teamwork.

Preparation and Development:

Give a problem that matches the experience level of the cadets.

Provide time to analyze it.

Responses to the problem should be recorded under four headings:

1. Facts,
2. Assumptions,
3. Problems, and
4. Solutions.

Advantages:

- Cadets can help each other learn.
- High energy.
- Relates to real-life applications.
- Can be used for past, present and future applications.

Disadvantages:

- Must be well organized and facilitated to ensure learning takes place.

Methods

Write a method of instruction in each rectangle. Listen to each group present their method. In each cloud, list some characteristics defining the method.

The form consists of two rows of three thought bubbles each. Each thought bubble is a cloud-like shape with a small tail leading to a rectangular box. The thought bubbles are intended for listing characteristics of a method, and the boxes are for writing the method of instruction.

THIS PAGE INTENTIONALLY LEFT BLANK

METHOD MADNESS

Topic: _____

Group Members: _____

Discuss the factors below in order to reach a decision on adopting a method of instruction.

<p>Is the objective to:</p> <ul style="list-style-type: none"> • provide theory? • manual or procedural skills? • develop concepts? • instill desired attitudes? • develop teamwork? 	<p>What is the type of content:</p> <ul style="list-style-type: none"> • Knowledge? • Theory? • How difficult is it?
<p>Know your cadets by determining the:</p> <ul style="list-style-type: none"> • existing skill, knowledge and attitude level of the students, • class size, • behaviour, • qualifications, • experience, and • skill level. 	<p>Establish Materials / Equipment / Facilities:</p> <ul style="list-style-type: none"> • What? • Where? • Available? • Time? • Is it critical?
<p>Consider cost:</p> <ul style="list-style-type: none"> • Are funds available? • Is it cost effective? 	<p>Know your ability as an instructor by determining:</p> <ul style="list-style-type: none"> • Existing skill, knowledge and attitude level? • Behaviour? • Availability? • Qualification? • Experience? • Skill level?

THIS PAGE INTENTIONALLY LEFT BLANK

METHODS OF INSTRUCTION SUMMARY

Interactive Lecture. The instructor presents material such as events and facts and the cadets participate by responding to questions and engaging in discussion.

Examples:

Demonstration and performance. The instructor demonstrates a movement or skill, showing the cadet what to do, and explains, why, where and when it is applied. Then the cadets are given time to practice the movement or skill.

Examples:

In-class activity. A variety of activities that reinforce instructional topics.

Examples:

Practical activity: An interactive way to allow cadets to experience skill-based lessons.

Examples:

Game. Fun and challenging activity that allows for skill practice or knowledge confirmation.

Examples:

Field trip. Complements theoretical knowledge required by using concrete examples and allowing cadets to observe real-life applications of learning objectives.

Examples:

Group discussion. Cadets learn from peer responses, which provoke them to examine their own thoughts and experiences.

Examples:

Guided discussion. The instructor directs and stimulates the cadets' learning through a series of structured questions.

Examples:

Role-play. Cadets are assigned roles requiring them to interact with others in responding to various realistic situations.

Examples:

Experiential learning. Allows cadets to acquire new knowledge or skills through direct experience.

Examples:

Problem-based learning. Cadets analyze a problem and apply the steps in the problem-solving method.

Examples:

Case study. The primary purpose may not be to find a correct solution to the problem or issue posed, but to understand the principles involved in reaching a solution or analyzing an issue.

Examples:



**COMMON TRAINING
PROFICIENCY LEVEL FOUR
INSTRUCTIONAL GUIDE**



SECTION 2

EO M409.02 – IDENTIFY ELEMENTS OF A POSITIVE LEARNING ENVIRONMENT

Total Time:

60 min

PREPARATION

PRE-LESSON INSTRUCTIONS

Resources needed for the delivery of this lesson are listed in the lesson specification located in A-CR-CCP-804/PG-001, *Proficiency Level Four Qualification Standard and Plan*, Chapter 4. Specific uses for said resources are identified throughout the instructional guide within the TP for which they are required.

Review the lesson content and become familiar with the material prior to delivering the lesson.

Photocopy the Create a Positive Learning Environment Crossword Puzzle located at Attachment B for each cadet.

Ensure the different types of attention signals described in TP 3 are available for this EO.

PRE-LESSON ASSIGNMENT

Nil.

APPROACH

An interactive lecture was chosen for TPs 1 and 3 to provoke thought and stimulate the cadets' interest in the importance of a physically and emotionally safe learning environment and a well-managed classroom / training area.

A group discussion was chosen for TP 2 as it allows the cadets to interact with their peers and share their knowledge, experiences, opinions and feelings about stress management.

INTRODUCTION

REVIEW

Nil.

OBJECTIVES

By the end of this lesson the cadet shall have identified the importance of a physically and emotionally safe learning environment, discussed various techniques to manage stress and discussed classroom / training area management techniques.

IMPORTANCE

It is important for the cadets to identify elements of a positive learning environment because it will provide them with specific instructional strategies for motivating and engaging the cadets, for conducting interesting lessons and for boosting the cadets' self-confidence and self-esteem.

Teaching Point 1**Describe the importance of a physically and emotionally safe learning environment.**

Time: 15 min

Method: Interactive Lecture



The cadets should be able to relate to sitting in a classroom trying to listen to an instructor who may have been knowledgeable about the subject but who was unable to engage them. Brainstorm with the cadets the reasons why they may have been unable to concentrate on the lesson. Draw out aspects of the environment such as lighting, ventilation, physical space, the instructor's attitude toward the group and the cadets' relationship with their peers. Explain that these are aspects of the learning environment that directly affect their ability to learn.

THE IMPORTANCE OF A PHYSICALLY AND EMOTIONALLY SAFE LEARNING ENVIRONMENT

"Everything we know or sense about the world comes to us, in one way or another, through the environment in which we live." (Bell, 2007, <http://www.dialogueonlearning.tc3.edu/model/environment/Introduction-grp.htm>)

The learning environment includes the "physical environment" of the classroom or training area and the "emotional environment" that the cadets and instructor create in the classroom or training area. Aspects of the physical and emotional environment such as the lesson location, availability of resources, and cadets' level of stress and anxiety affect learning but are sometimes outside of the instructors' control. However, it is important that instructors try to minimize the effects of such hindrances to learning when they plan their lessons rather than simply know they exist and feel powerless to change them.

Physical Environment

The physical environment for cadet training will most likely change from training session to training session or even from lesson to lesson. Instructors fortunate enough to have a dedicated learning space will find it easier to create a stimulating physical environment, while others who are transient will find it more difficult. The first priority when considering the physical environment is safety. As a minimum standard the physical environment should have:

Adequate lighting. The connection between light and our emotions has long been recognized. Studies have also shown that learners perform better in brightly-lit learning environments than dimly-lit ones. It has also been shown that a learning environment with lots of natural light is more conducive to learning.

Good ventilation. It is important to be conscious of the temperature and air quality in a room because people are especially sensitive to these two elements. Cooler temperatures promote relaxation and receptivity while warmer temperatures promote acting out. If possible, open a window, turn on a fan or open a door to control temperature and air quality.

A colourful atmosphere. There is a connection between colour and moods and emotions. Warm colours (eg, red, orange, yellow) are exciting and may lead to acting out while cool colours (eg, blue, green, purple) are more relaxing. Researchers in brain-based learning suggest that the best colours for elements of the physical environment are yellow, light orange, beige or off-white. The cadets may react differently to the same colour depending on their emotional state. If cadets are feeling stressed, the colour red, for example, may bring out aggressive feelings but if they are relaxed, red can attract their attention.



The physical environment can be improved by adding colourful, visually appealing posters, pictures or other graphic images to the walls. If an instructor lacks control over these elements they should ensure that learning aids (handouts, electronic presentations, transparencies or flip charts) are colourful.

Flexible seating arrangements. The instructor should set up a learning environment that allows cadets to move quietly to take part in small and whole group learning activities. Having the cadets move from large to small group interactions will provide variety help them learn new material more efficiently.

Movement. Cadets learn better if there is movement during a period of instruction. The brain needs glucose, oxygen and water to function properly. Even if the air quality is good, the cadets may still be oxygen deprived because of improper breathing patterns caused by stress and anxiety. Lack of oxygen to the brain negatively impacts its ability to process information; increasing the flow of oxygen to the brain can improve its ability to process information. Physical activity is an excellent way to increase oxygen flow to the brain. Instructors can accomplish this by beginning their classes with 30–60 seconds of stretching or deep breathing and by taking breathing breaks during longer lessons or when they notice that the cadets' attention is lagging.

Water is also important for good brain functioning. Instructors should encourage the cadets to drink beverages, preferably water or fruit juices during lessons.



The brain consumes twenty percent of the body's energy.



Organize the cadets into pairs and have them alternate as they explain to one another how adequate lighting, good ventilation, colourful atmosphere, flexible seating arrangements and movement affect learning. Circulate around the room to get a sense of how well the cadets are processing the information. After all cadets have participated and all elements have been explained, continue with the lesson.

Emotional Environment



"Learning occurs best in an environment that contains positive interpersonal relationships and interactions, comfort and order, and in which the learner feels appreciated, acknowledged, respected and validated." (Earl, 2003, p. 39)

Instructors have a responsibility to make their classrooms as emotionally safe as possible so that learning can take place. If the brain senses a threat, it will ignore all other information to deal effectively with the threat. The perception of threat causes a "fight or flight" response which causes the body to transfer blood from the frontal cortex, or thinking part of the brain, to the bottom and back of the brain to prepare for survival. Any time cadets experience a sense of danger, whether physical or emotional, their bodies and brains react with this "fight or flight" response.

To maximize learning, instructors must create an emotional environment of relaxed alertness that allows the cadets to risk saying a wrong answer or solving a problem incorrectly. This is an emotionally safe learning environment.



Emotional safety is necessary for intellectual risk taking. (Earl, 2003, p. 103)

There are a number of strategies that can be used to achieve an emotionally safe learning environment. It is important for the instructor to:

Lead with a positive attitude. The cadets may have plenty of complications and negativity in their daily lives and will appreciate a positive environment with a positive and enthusiastic instructor. When instructors show interest in what they are teaching, the cadets will become interested as well.

Establish a friendly learning environment. The instructor should make it safe to learn by treating all cadets equally and respectfully and insisting that cadets treat one another in the same way. The instructor can build trust by keeping their word and by keeping information confidential if asked to do so. They should encourage the sharing of ideas, experiences and information and value the contribution of each learner. One simple thing that instructors can do is to be sensitive to the cadets' average attention span.



Use a maximum of one minute per year of age, as a guide, to get uninterrupted listening or active participation in an activity.

Make learning fun. The instructor should challenge the cadets with interesting activities that are not too easy or too difficult. They should try to challenge the cadets just beyond their present level of ability. If they are challenged too far beyond their level of ability, the cadets will give up but if they are challenged too little, they will become bored. Encourage the cadets to take risks and reward effort and energy as well as correctness. The instructor should listen empathetically by acknowledging nervousness, showing patience and being non-judgmental of the cadets' responses. In addition, the instructor should never single out cadets and always be attentive to those who seem isolated from the group. They should never use put-downs or sarcasm.



Instructors should keep the first challenge easy and the encouragement heavy and remember that they are students too but with the added responsibility of helping others learn.

Encourage supportiveness. The instructor should be supportive of the cadets and encourage them to be supportive of one another. Instructors can create a supportive environment by leading applause, thanking cadets for their input and rewarding effort.

Appeal to a variety of senses. The instructor should stimulate the cadets' senses in a variety of ways which will help them feel positive about the learning experience. As well, the instructor should be aware that the cadets will have different learning styles that should be catered to by using many different learning activities.

Provide feedback. The instructor's feedback should be specific and help the cadets compare their current progress to past performance rather than compare it to the performance of others. They should always be accurate and consistent and when they assign specific tasks to be done, they should tell the cadets that they will be coming back to check on their progress.



When providing feedback, the instructors should stress what is to be done rather than confuse the cadets by giving attention to what is not to be done.

Use encouragement. The instructor should use encouragement to boost the cadets' enthusiasm and self-esteem but must be careful not to confuse encouragement with reinforcement. Encouragement will make the cadets feel better but it will not improve their learning in the same way as providing specific feedback regarding a specific task. Instructors should be selective and provide encouragement when it is due to keep the cadets on track.



Instructors should encourage the cadets to look at incorrect responses or unsuccessful attempts at problem solving as research and not failure.

Communicate clear expectations and routines. A sense of safety comes from consistent and predictable behaviours on the part of the instructor. Instructors should not be too rigid but should develop consistent procedures for beginning lessons, getting the cadets' attention and handling disruptions and distractions. They should start every lesson by telling the cadets specifically what they will know or be able to do by the end of the lesson. They should conclude each lesson by reminding the cadets what they have learned or are able to do.

Provide processing time. Instructors should ensure that the cadets have enough time to process the information that they have just received. They should stop periodically during a lesson and allow the cadets to interact over new material which will help them store it in long-term memory for later recall. Instructors can use a variety of group or paired activities to enable the cadets to interact with one another. They can, for example, ask each cadet in a small group to successively respond to a question or comment on an idea. A variation of this type of interaction would be pairing cadets and having them respond alternately by listing one item of a series, by identifying a specific cause or effect of something or by providing a specific reason. The key is for the instructor to stop talking, ask a question, set a time limit and have the cadets interact in groups or pairs to process the information just presented.



Talking or lecturing beyond ten minutes is like pouring water into a glass that is already full.

Instructors must ensure, as much as possible, that the environment in which they instruct their lessons is learner friendly. The environment does affect learning and instructors must find ways to positively impact the learning environment for the cadets. The cadets should feel comfortable when giving answers, taking part in discussions and solving problems. Their incorrect responses to oral questions or attempts at solving a problem should not be put down or belittled but rather should be seen as the beginning of discovery.



Adult learners can overcome a poor learning environment because they are often self-motivated with a genuine interest in the subject or desire for personal gain. Cadets may not have a high degree of self-motivation so it is important to create a learning environment that will motivate them.

CONFIRMATION OF TEACHING POINT 1

Organize the cadets into pairs and have them alternately explain to one another two ways the instructor can establish a friendly learning environment, make learning fun and provide processing time.

Circulate around the room to get a sense of how well the cadets are processing the information. After all cadets have participated and the three items have been explained, continue with the lesson.

Teaching Point 2**Conduct a group discussion on stress management techniques.**

Time: 15 min

Method: Group Discussion

BACKGROUND KNOWLEDGE

The purpose of the group discussion is to draw the following information from the group using the tips for answering / facilitating discussion and the suggested questions provided.

STRESS

Stress is the body's reaction to a perception of a physical or emotional threat. The threat can be real or imagined; it is the perception of threat that triggers the stress response. During an acute stress response, the nervous system is activated automatically and the body experiences increased levels of cortisol, adrenalin and other hormones that produce an increased heart rate, quickened breathing rate and higher blood pressure. Blood is carried from the extremities to the big muscles preparing the body to fight or run away, which is commonly known as the "fight or flight" response. When the perceived threat is gone, our systems are designed to return to normal but this doesn't always happen because the threats can be frequent which causes constant anxiety.

Positive and negative stress are commonly labelled as eustress and distress respectively.

Eustress

Eustress is described as good stress and is created naturally when we participate in exciting but safe activities or when we trick the body into releasing small amounts of cortisol into the bloodstream. This type of stress pushes a person to do better and reach goals. Situations that might produce eustress include:

- riding a roller coaster;
- successfully completing an activity; or
- passing a test.



The prefix 'eu' in the word eustress is taken from the word euphoria which means a feeling of well being.

Distress

Distress is described as bad stress. This type of stress causes worry, anger or pain. Situations that might produce distress include:

- lack of sleep,
- accidents, or
- negative relationships with others.



Stress affects individuals differently. A situation that causes eustress for one person may cause distress for another.

TECHNIQUES FOR CREATING POSITIVE STRESS

Positive stress releases a small amount of cortisol into the bloodstream which can help the cadets learn more easily by improving their memory function. The instructor should use techniques, such as those described below, to create positive stress.

Design activities that challenge cadets. The instructor should design activities that challenge the cadets just beyond their present level of ability to encourage interest and prevent boredom.

Use movement. Instructors should incorporate movement into every lesson because it increases oxygen flow to the brain, which helps the cadets learn better. The movement should occur naturally during the lesson when the cadets are forced to stand up to give responses or move around to engage in a learning or confirmation activity. It does not have to be long but should be frequent during a lesson, which can have a cumulative effect on the brain.

Use music. Music, in addition to being enjoyable, has health benefits because it helps the body to produce cortisol. Instructors should have a good selection of music that they regularly use during their lessons as background noise or as an attention signal to begin a lesson or transition from one activity to another.

Breathe Properly. Breathing is how oxygen gets into the bloodstream to be delivered to the rest of the body. As automatic as it is, cadets may not be breathing well and should practice deep breathing activities to help increase oxygen flow.



Conduct a deep breathing activity by having the cadets:

1. lie on the floor on their back or sit in a comfortable position;
2. place one hand on their upper chest and one hand on their belly just above their waist;
3. breathe in slowly through their nose and feel the hand on their belly rise;
4. breathe out slowly through their mouth and feel the hand on their belly gradually lower; and
5. repeat steps three and four a few times.

If this activity is too disruptive or time consuming, simply encourage the cadets to take a few deep breaths periodically throughout a lesson to get more oxygen from the bloodstream to the brain, which will improve brain function.

TECHNIQUES FOR CONTROLLING NEGATIVE STRESS

If threats, or the perception of threats, are persistent, stress will become long term or chronic. The body can handle temporary or acute stress but not chronic stress and it may become ill. At the least, chronic stress impedes learning and must be prevented. In addition to using some of the techniques described above to create good stress, instructors should incorporate the following in their lessons to manage negative stress.



It is estimated that ninety percent of doctors' visits are for conditions in which stress, at least, plays a role.

Inform cadets of expectations. Instructors must clarify their expectations and communicate them to the cadets. Be specific, when assigning tasks, about what cadets will be expected to do, how they will be assessed and how they will receive extra training if necessary. Develop routines for beginning a lesson, transitioning from one activity to another during a lesson, getting the cadets' attention, dealing with different types of learners and ending a lesson. Routines may be repetitive and the cadets may complain at first, but routines that are realistically developed and consistently applied will allow the cadets to predict what will happen, which will ease their stress.

Provide necessary resources. The instructor must clearly and specifically inform the cadets what is expected of them and ensure that the cadets have all the material they need to complete the learning activity. The cadets will have limited time to complete the activity and will become frustrated if they have to collect material or improvise on their own. The instructor must ensure that all necessary equipment and supplies are readily available in the learning environment.

Provide adequate time to accomplish the task. When determining the amount of time for a task a good rule to follow is to assign one minute for each year of age. If an activity is long it should be broken down into manageable tasks.

Incorporate physical activity. The instructor should ensure that cadets move during every class either naturally as part of an activity or artificially when they notice the cadets' attention lagging.

Provide time to process information. Give the cadets enough time during a task to interact with their peers, in some way or another, over the content to help move it into long-term memory. This can be accomplished in a number of ways such as group interactions or some form of paired sharing. The important thing is to prevent time from becoming a hindrance to learning.

Practice relaxation techniques. There are a number of relaxation techniques to control negative stress. The benefit of such techniques is that they trick the body into thinking that the threat is gone and the increased blood circulation carries more oxygen to the brain, which allows the body to relax.

GROUP DISCUSSION



TIPS FOR ANSWERING / FACILITATING DISCUSSION:

- Establish ground rules for discussion, eg, everyone should listen respectfully; don't interrupt; only one person speaks at a time; no one's ideas should be made fun of; you can disagree with ideas but not with the person; try to understand others as much as you hope they understand you; etc.
- Sit the group in a circle, making sure all cadets can be seen by everyone else.
- Ask questions that will provoke thought; in other words avoid questions with yes or no answers.
- Manage time by ensuring the cadets stay on topic.
- Listen and respond in a way that indicates you have heard and understood the cadet. This can be done by paraphrasing their ideas.
- Give the cadets time to respond to your questions.
- Ensure every cadet has an opportunity to participate. One option is to go around the group and have each cadet answer the question with a short answer. Cadets must also have the option to pass if they wish.
- Additional questions should be prepared ahead of time.

SUGGESTED QUESTIONS:

- Q1. What is stress?
- Q2. How does breathing deeply help create positive stress?
- Q3. What are five things instructors can do to control negative stress?
- Q4. How can practicing relaxation techniques help control negative stress?
- Q5. How does music create positive stress?



Other questions and answers will develop throughout the group discussion. The group discussion should not be limited to only those suggested.



Reinforce those answers given and comments made during the group discussion, ensuring the teaching point has been covered.



If time allows, conduct an activity where the cadets will practice one of the relaxation exercises described in Attachment A.

CONFIRMATION OF TEACHING POINT 2

The cadets' participation in the group discussion will serve as the confirmation of this TP.

Teaching Point 3

Identify classroom / training area management techniques.

Time: 20 min

Method: Interactive Lecture

The classroom / training area for cadets may vary from session to session or even lesson to lesson depending on the type of training being conducted and the space available at the unit. Even if the instructor has the luxury of a dedicated space, it is important that they develop a classroom / training area management plan that will maximize the time available for a lesson. A management plan will prevent the instructor from wasting time getting the cadets' attention, transitioning from one activity to another, handling distractions and dealing with different types of learners.

A management plan should include the following but can be more detailed.

ATTENTION SIGNALS



Attention signals will work only if the cadets know what to do upon hearing or seeing the signal and the instructor has a positive expectation of success. If you do it, but do not actually expect the cadets to give you their attention, most likely they will not.

The instructor may find it useful to use an attention signal which immediately captures the cadets' attention when beginning a lesson, giving instructions, passing on information or transitioning from one activity to another. The attention signal should be both auditory and visual and the cadets should be taught to stop talking, stop working and establish eye contact immediately upon hearing and seeing the signal. Such an approach, when it becomes entrenched into the lesson's routine, will prevent the instructor from becoming frustrated and will help establish a calm tone for the lesson. The attention signal should be used consistently whenever there is a need to get the cadets' attention. The following attention signals may be used:

- **Raising a hand.** The instructor can simply raise their hand or raise their hand and say, "high five." Immediately upon hearing the phrase "high five" and seeing the instructor's hand go up the cadets should stop talking or moving, look at the instructor, raise their hand and repeat the phrase "high five" and keep their hand raised until the group is ready.
- **Flicking the light switch.** Immediately upon seeing the lights go on and off, the cadets should stop talking or moving and look at the instructor until the group is ready. An accompanying verbal command may include "high five" or some other phrase.
- **Sounding a bell, playing a musical tone or playing part of a song.** Immediately upon hearing the bell, musical tone or part of a song, the cadets should stop talking or moving and look at the instructor until the group is ready.
- **Clapping a rhythm.** The instructor claps a rhythm (dut, dut, dut, dut, dut). Immediately upon hearing the clapped rhythm the cadets should stop talking or moving, clap either a responding rhythm (dut, dut) or repeat the rhythm the instructor clapped and then look at the instructor until the group is ready.

- **Whistling.** Immediately upon hearing the whistle the cadets should to stop talking or moving and look at the instructor until the group is ready.



Use one of the attention signals and have the cadets respond with the appropriate behaviour or play the chorus from the song "Respect", have the cadets repeat "R-E-S-P-E-C-T" when they hear it and look at the instructor until the group is ready.



This is not an exhaustive list of attention signals. Some of the signals described above may be too childish for some groups. When deciding on a signal, consider the age, experience and maturity level of the group. Additional research of attention signals and experimenting with the group may help find one that works.

CORRECTING BEHAVIOUR

Instructors must be able to resolve disagreements, draw attention to the merits of differing opinions and maintain control of the classroom. They should prepare ahead of time and have a contingency plan for a range of behaviours similar to those listed below:

LEARNER BEHAVIOUR	SOLUTIONS
<p>Quick Learner</p> <p>The cadet who consistently grasps concepts quickly and finishes work first could become disruptive if they begin to feel bored and unchallenged.</p>	<p>Provide this cadet with more advanced work.</p> <p>Ask this cadet to help others who require help.</p> <p>Have extra work prepared that reinforces the lesson.</p>
<p>Quiet Learner</p> <p>The cadet who rarely participates because they are shy, afraid, self-conscious or introverted.</p>	<p>Determine the cadet's interest and make it a topic for a group discussion. Discreetly encourage them to speak on the topic during the discussion asking questions that require short answers but occasionally ask more detailed questions.</p>
<p>Helpful Learner</p> <p>The cadet who is eager to help and agrees with everything the instructor says.</p>	<p>If the cadet is truly a generous person, explain in private that their behaviour is appreciated but could be misinterpreted by the group.</p> <p>If the cadet is trying to gain the favour of the instructor, advise the whole group that only merit will be rewarded.</p>
<p>Monopolizer</p> <p>The cadet who is always ready to express their views and can end up monopolizing the lesson.</p>	<p>Pose questions to this cadet that require only brief "yes" or "no" answers.</p>

<p>Critical Learner</p> <p>The cadet who consistently finds fault with the content or method of instruction.</p>	<p>Listen to the cadet's problems and satisfy them, if possible. If not possible, admit there are areas to be improved and ask for suggestions and solutions. Advise the cadet that you would be happy to discuss these issues after the lesson.</p>
<p>Know It All</p> <p>The cadet who considers themselves an authority on any topic being discussed and disrupts the class.</p>	<p>Determine if the cadet is knowledgeable or simply trying to get attention. Allow the cadet to answer some questions but allow other cadets to respond as well.</p>
<p>Distracter</p> <p>The cadet who attempts to get the group off topic. The cadet may do this to avoid revealing that they have not completed the assigned work or to avoid a difficult subject.</p>	<p>Recognize the types of questions that appear to relate to the lesson but will actually veer off topic. Acknowledge that the question does not relate to the topic but offer to discuss it after the lesson.</p>



Organize the cadets into pairs and have them alternately describe to one another the different types of learners. Circulate around the room to get a sense of how well the cadets are processing the information. After all cadets have participated and the different types of learners have been described, continue with the lesson.

PROVIDING POSITIVE REINFORCEMENT

Deal with inappropriate academic performance and / or behaviour by emphasizing what is expected of the cadet rather than concentrating on what the cadet did wrong. The feedback should be:

- accurate,
- age-appropriate,
- specific, and
- consistent with the instructor's personal style.

It is extremely frustrating for cadets to be advised that their performance is unsatisfactory but to not know why. Instructors must:

- specifically and clearly identify what aspect of a performance is incorrect; and
- specifically and clearly identify what the cadet must do differently.

The cadets should also be asked to identify their own mistakes and explain why they made the error. In addition, the cadets should also be given the opportunity to:

- explain how to perform the task correctly; and
- practice the correct procedure.

ENGAGING THE CADET

Cadets are engaged when they are moving around or working in groups to manipulate information physically and mentally. Instructors can enhance learning by engaging in activities such as those described below.

Jigsaw worksheets. Instead of having cadets complete a worksheet individually, break them into small groups and assign a portion of the worksheet to each group. Each group must complete its assigned portion of the worksheet and use a poster or some other presentation aid to present the information to the whole group.

Graphics. Have the cadets create graphic organizers such as webs or mobiles to summarize information.

Creative writing. Have the cadets create rhymes, poems or songs to summarize information. If you are teaching terminology, symbols or similar information, have the cadets write a fairy tale or children's story using the information.

Create a chart. The instructor should type chronological information using a large font and cut it up into strips. Organize the cadets into pairs or small groups and give each pair or group an envelope with the strips of information and have them work together to place the information in the correct order and paste it on a sheet of chart paper or bristol board. Time the activity for fun.

Information chain. Have each cadet write one fact that they have learned during the class on a piece of coloured paper if possible. Have the class line up in front of the room and invite the first cadet to read their slip then fold it into a link and staple it. Invite the next student to read a fact and attach it to the chain and continue in this fashion until all cadets have created a link.

Scavenger hunt. Teach identification lessons such as parts of a rifle or parts of an airplane by planting clues around the room and having cadets engage in a scavenger hunt. The clues may be actual items or pictures of items. When cadets find an actual item or some representation of it, they must describe the item to the group.

Road trip. Create a road trip. Place stop signs around the room containing information describing what the cadet must do. The cadets will travel to each place, complete the activity and have their passport stamped.



Organize the cadets into pairs and have them alternately explain to one another the different ways instructors can engage cadets. Circulate around the room to get a sense of how well the cadets are processing the information. After all cadets have participated and all activities have been explained, continue with the lesson.

MANAGING DISTRACTIONS

The best way for instructors to manage distractions is to prevent them from occurring by engaging the cadets in learning. Use attention signals to get the cadets' attention at the beginning of a lesson, while conducting an activity during a lesson and when transitioning from one activity to another. Instructors can prevent distractions by developing and consistently using routines that help cadets to predict the instructor's behaviour. Disruptions often occur when the cadets move from one activity to another during a lesson. Instructors should structure transitions by answering the following questions:

- Can the cadets talk during transitions?
- How can the cadets get the instructor's attention during a transition?
- What is the purpose of the transition?
- Can the cadets move during the transition?
- What is the desired behaviour during a transition?

Once a procedure has been established, the instructor should teach the cadets the structure through direct instruction and patient practice until the group responds appropriately. A possible approach to teaching transitions could include:

- calling the cadets to attention with the attention signal;
- numbering the cadets and assigning each number a specific task;
- informing the cadets of the rules regarding talking and moving around the room;
- informing the cadets of the procedure for getting the instructor's attention; and
- informing the cadets of the time permitted for the transition.



Instructors should encourage the cadets either individually or collectively when they may not expect it. Such encouragement may be particularly rewarding and will be considered genuine because it is attached to past behaviour and not necessarily designed to provoke further activity from the cadet.

CONFIRMATION OF TEACHING POINT 3

QUESTIONS:

- Q1. What is an attention signal?
- Q2. Identify one solution for dealing with cadets who get finished before others and become disruptive.
- Q3. Identify two questions instructors should answer to structure transitions.

ANTICIPATED ANSWERS:

- A1. An attention signal is a visual or auditory signal that immediately captures the cadets' attention when the instructor begins a class, gives instructions, passes on information or transitions from one activity to another.
- A2. Solutions include:
- providing the cadet with more advanced work;
 - asking the cadet to help others; or
 - having extra work prepared that reinforces the lesson.
- A3. Can the cadets talk during transitions?
- How can the cadets get the instructor's attention during a transition?
- What is the purpose of the transition?
- Can the cadets move during the transition?
- What is the desired behaviour during a transition?

END OF LESSON CONFIRMATION

Have the cadets complete the Create a Positive Learning Environment Crossword Puzzle located at Attachment B.

Review answers using the Create a Positive Learning Environment Crossword Puzzle Answer Key located at Attachment C.

CONCLUSION

HOMEWORK / READING / PRACTICE

Nil.

METHOD OF EVALUATION

This EO is assessed IAW A-CR-CCP-804/PG-001, *Proficiency Level Four Qualification Standard and Plan*, Chapter 3, Annex B, 409 PC.

CLOSING STATEMENT

Creating a positive learning environment requires planning and work by instructors. A safe, respectful and positive learning environment is more than a boost to self-confidence and self-esteem or a way to make learning fun—it is the cadet's right and an excellent way to make them want to learn.

INSTRUCTOR NOTES / REMARKS

Nil.

REFERENCES

A0-055 A-P9-050-000/PT-006 Director Training and Education Policy. (2002). *Canadian Forces individual training and education system* (Vol. 6). Ottawa, ON: Department of National Defence.

A0-118 Director Cadets 3. (2007). *Youth reference guide*. Ottawa, ON: Department of National Defence.

C0-191 ISBN 978-0-7360-6675-4 Corbin, C. & Lindsey, R. (2007). *Fitness for life: Updated fifth edition*. Windsor: Human Kinetics.

C0-375 ISBN 978-1-879097-10-0 Kagan, S., & Kagan, M. (2009). *Kagan cooperative learning*. San Clemente, CA: Kagan Publishing.

C0-376 ISBN 0-7619-4626-8 Earl, L. M. (2003). *Assessment as learning*. Thousand Oaks, CA: Corwin Press, Inc.

C0-380 Scott, E. (2008). *Cortisol and stress: How to stay healthy*. Retrieved February 25, 2009, from <http://www.Stress.about.com/od/stresshealth/a/cortisol.htm?p=1>

C0-381 McDonald, E. (2006). *How to involve and engage students*. Retrieved March 4, 2009, from http://www.education-world.com/a_curr/columnists/mcdonald/mcdonald007.shtml

C0-382 Bear, T. C. (2009). *Quiet signals for getting attention and control of your classroom*. Retrieved February 27, 2009, from <http://www.teachercreated.com/blog/?tag=attention-signals>

C0-383 Bell, A. (2007). *Creating a learning centered environment—Introduction*. Retrieved February 23, 2009, from <http://www.dialogueonlearning.tc3.edu/model/environment/Introduction-grp.htm>

C0-384 Handy, K. (2009). *Classroom management plan*. Retrieved February 27, 2009, from <http://www.katiehandy.wordpress.com/classroom-management-plan/>

C0-385 Boudreau, D. (2008). *Creating the ideal learning environment—Emotional*. Retrieved February 25, 2009, from <http://ezinearticles.com/?Creating-the-Ideal-Learning-Environment---Emotional&id=1536435>

RELAXATION EXERCISES

Rag Doll

1. Sit in a chair (or stand) with feet apart.
2. Stretch the arms and trunk upward and inhale.
3. Exhale and drop the body forward. Let the trunk, head and arms dangle between the legs, keeping the muscles relaxed (as illustrated in Figure 1).
4. Remain in this position for 10–15 seconds.
5. Slowly roll up, one vertebrae at a time.

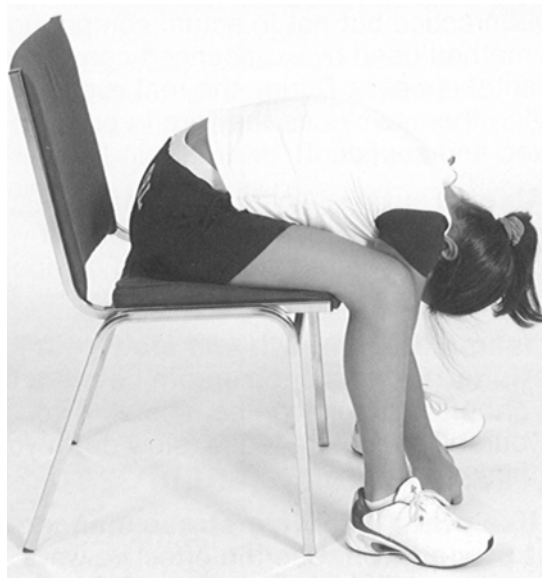

Figure A-1 Rag Doll

Note. From *Fitness for Life: Updated Fifth Edition* (p. 300), by C. Corbin, & R. Lindsey, 2007, Windsor, ON: Human Kinetics. Copyright 2007 by The Cooper Institute.

Neck Roll

1. Sit in a chair or on the floor with legs crossed.
2. Keeping the head and chin tucked, inhale and slowly turn the head as far left as possible (as illustrated in Figure 2).
3. Exhale and turn the head to the centre.
4. Repeat steps 2–3 for the right side.
5. Repeat steps 2–4 three times, trying to turn further each time to feel the stretch in the neck.
6. Drop the chin to the chest and inhale while slowly rolling the head in a semicircle to the left shoulder and exhale while slowly rolling the head back to the centre.
7. Repeat step 6 for the right side.



Do not roll the head backward or in a full circle.



Figure A-2 Neck Roll

Note. From *Fitness for Life: Updated Fifth Edition* (p. 300), by C. Corbin, & R. Lindsey, 2007, Windsor, ON: Human Kinetics. Copyright 2007 by The Cooper Institute.

Body Board

1. Lie on the right side with arms over the head (as illustrated in Figure 3).
2. Inhale and stiffen the body like a wooden board.
3. Exhale and relax the muscles and collapse.
4. Let the body fall without trying to control the direction (as illustrated in Figure 4).
5. Lie still for ten seconds.
6. Repeat steps 1–5 for the left side.



Figure A-3 Body Board Start Position

Note. From *Fitness for Life: Updated Fifth Edition* (p. 301), by C. Corbin, & R. Lindsey, 2007, Windsor, ON: Human Kinetics. Copyright 2007 by The Cooper Institute.



Figure A-4 Body Board Finish Position

Note. From *Fitness for Life: Updated Fifth Edition* (p. 301), by C. Corbin, & R. Lindsey, 2007, Windsor, ON: Human Kinetics. Copyright 2007 by The Cooper Institute.

Jaw Stretch

1. Sit in a chair or on the floor with head up and arms and shoulders relaxed.
2. Open mouth as wide as possible and inhale.
3. Relax and exhale slowly.
4. Shift the jaw to the right as far as possible and hold for three seconds (as illustrated in Figure 5).
5. Repeat step 4 for the left side.
6. Repeat steps 4–5 ten times.



Figure A-5 Jaw Stretch

Note. From *Fitness for Life: Updated Fifth Edition* (p. 301), by C. Corbin, & R. Lindsey, 2007, Windsor, ON: Human Kinetics. Copyright 2007 by The Cooper Institute.

CREATE A POSITIVE LEARNING ENVIRONMENT CROSSWORD PUZZLE

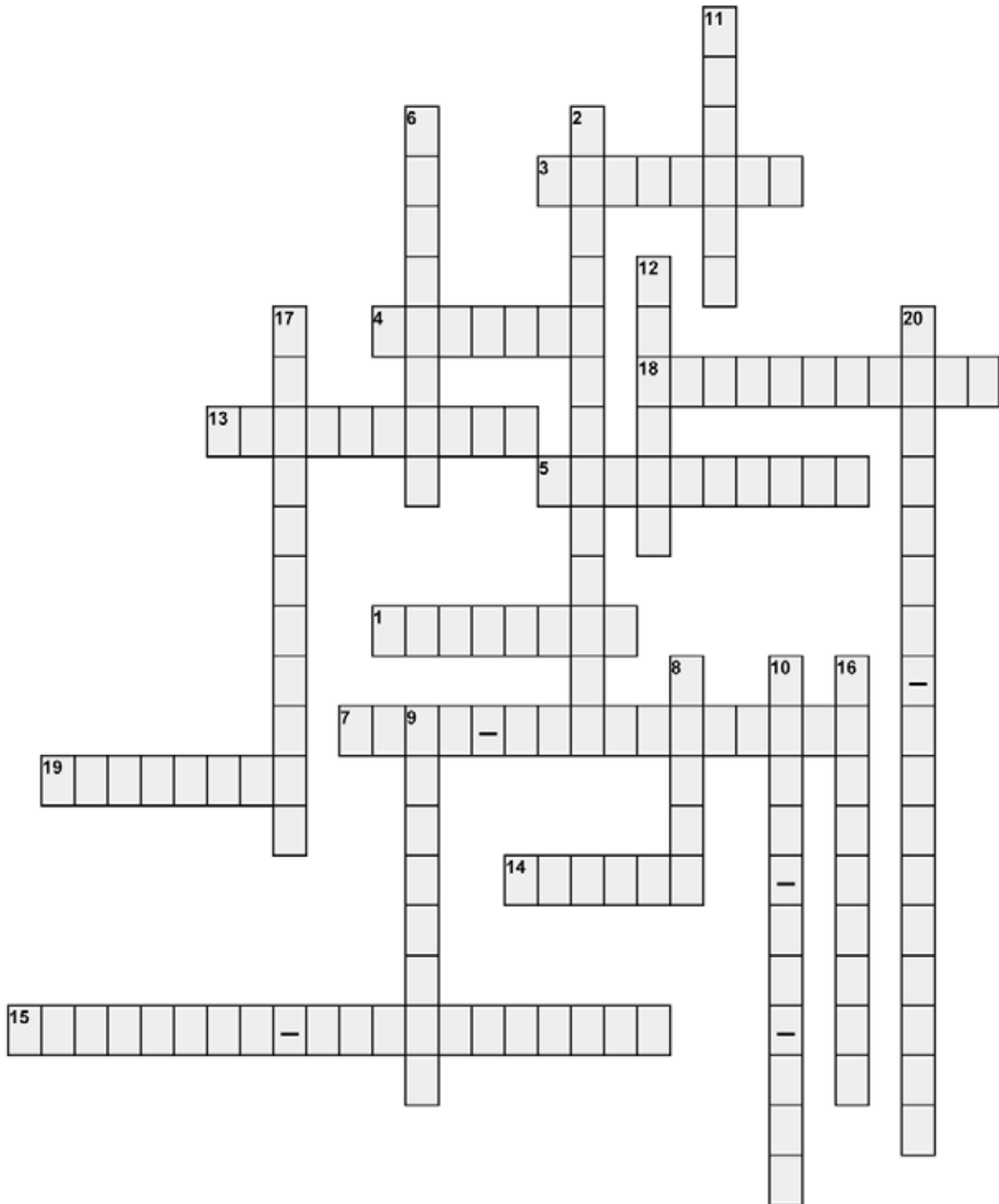

Word List

physical environment, relaxation, movement, brain, stress, relaxed alertness, memorable, past performance, predict, processing, eustress, distress, cortisol, visual, know it all, specific, self-esteem, quiet learner, emotionally, oxygen

Clues

Across:

1. Furniture should be arranged to allow for _____.
3. Positive stress is called _____.
4. Using consistent routines will help cadets _____ instructor behaviour.
5. Cooler temperatures lead to this _____.
7. Feedback should help cadets compare current progress with _____.
13. Moving information from working memory to long term memory is called _____ information.
14. Deep breathing helps get _____ into the blood stream.
15. The place where a lesson takes place is _____.
18. Reinforcement boosts learning but encouragement boosts _____.
19. Music and movement help the body to produce _____.

Down:

2. The cadet who rarely participates is called a _____.
6. Negative stress is called _____.
8. 20% of the body's energy is consumed by the _____.
9. Feedback should be accurate, age-appropriate, consistent and _____.
10. Cadets who think they are authorities on any topic are called _____.
11. Fight or flight is the body's response to _____.
12. Attention signals should be both auditory and _____.
16. When our senses are stimulated the learning experience will become more _____.
17. When cadets feel comfortable and relaxed the environment is said to be _____ safe.
20. To maximize learning the emotional environment should create _____.

CREATE A POSITIVE LEARNING ENVIRONMENT ANSWER KEY

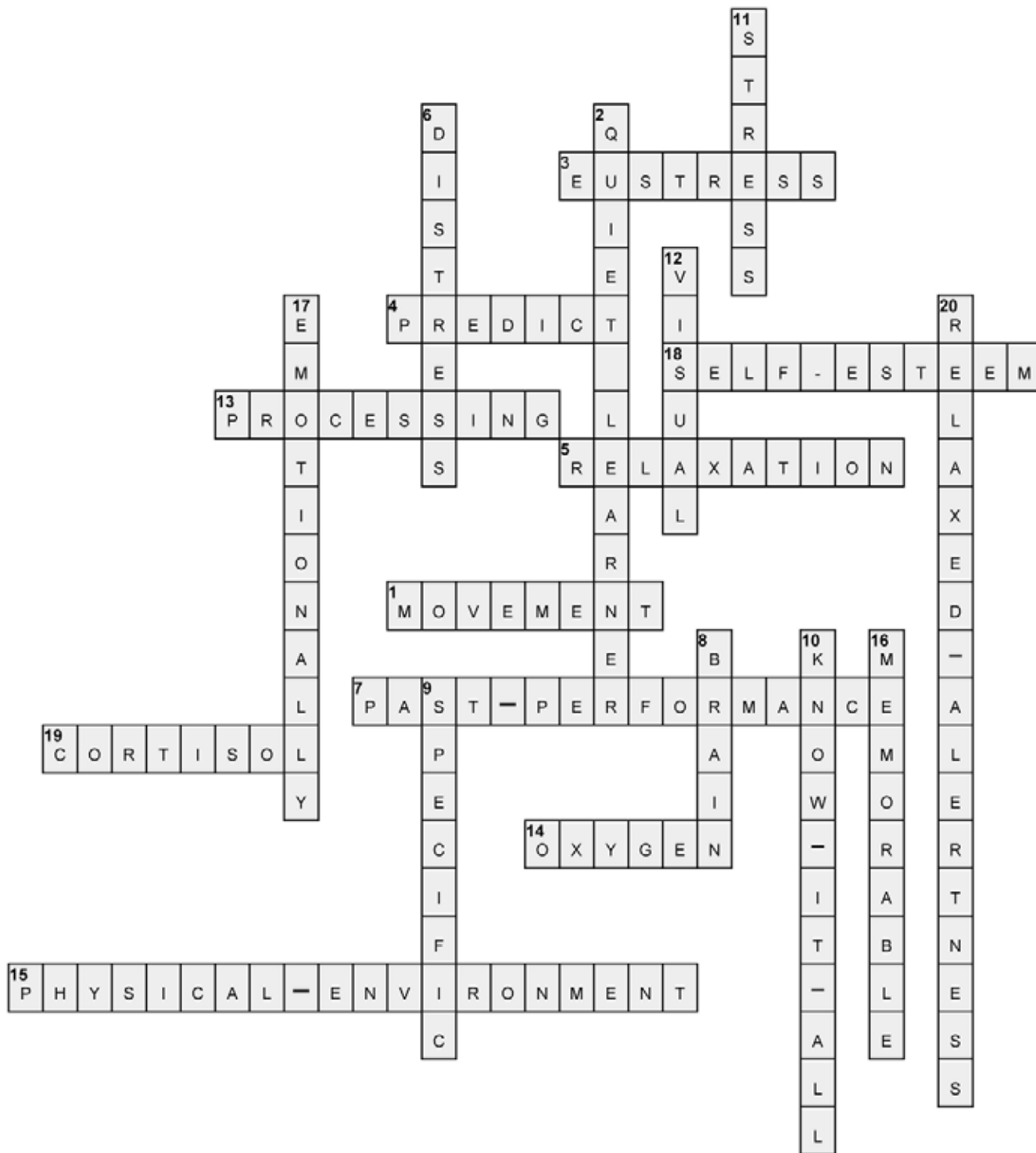

CREATE A POSITIVE LEARNING ENVIRONMENT ANSWER KEY (CONT'D)

Clues

Across:

1. Furniture should be arranged to allow for _____. (MOVEMENT)
3. Positive stress is called _____. (EUSTRESS)
4. Using consistent routines will help cadets _____ instructor behaviour. (PREDICT)
5. Cooler temperatures lead to this _____. (RELAXATION)
7. Feedback should help cadets compare current progress with _____. (PAST PERFORMANCE)
13. Moving information from working memory to long term memory is called _____. (INFORMATION PROCESSING)
14. Deep breathing helps get _____ into the blood stream. (OXYGEN)
15. The place where a lesson takes place is _____. (PHYSICAL ENVIRONMENT)
18. Reinforcement boosts learning but encouragement boosts _____. (SELF-ESTEEM)
19. Music and movement help the body to produce _____. (CORTISOL)

Down:

2. The cadet who rarely participates is called a _____. (QUIET LEARNER)
6. Negative stress is called _____. (DISTRESS)
8. 20% of the body's energy is consumed by the _____. (BRAIN)
9. Feedback should be accurate, age-appropriate, consistent and _____. (SPECIFIC)
10. Cadets who think they are authorities on any topic are called _____. (KNOW IT ALL)
11. Fight or flight is the body's response to _____. (STRESS)
12. Attention signals should be both auditory and _____. (VISUAL)
16. When our senses are stimulated the learning experience will become more _____. (MEMORABLE)
17. When cadets feel comfortable and relaxed the environment is said to be _____ safe. (EMOTIONALLY)
20. To maximize learning the emotional environment should create _____. (RELAXED ALERTNESS)



**COMMON TRAINING
PROFICIENCY LEVEL FOUR
INSTRUCTIONAL GUIDE**



SECTION 3

EO M409.03 – DESCRIBE LEARNER NEEDS

Total Time:

60 min

PREPARATION

PRE-LESSON INSTRUCTIONS

Resources needed for the delivery of this lesson are listed in the lesson specification located in A-CR-CCP-804/PG-001, *Proficiency Level Four Qualification Standard and Plan*, Chapter 4. Specific uses for said resources are identified throughout the instructional guide within the TP for which they are required.

Review the lesson content and become familiar with the material prior to delivering the lesson.

Create slides of Attachments A and H.

Photocopy and three-hole punch Attachments B, D, E, F, I and K for each cadet.

Photocopy Attachment C and cut into strips.

Make two copies of Attachments J and L.

Ensure that the cadets bring the binder provided in EO M409.01 (Identify Methods of Instruction).

PRE-LESSON ASSIGNMENT

Nil.

APPROACH

An interactive lecture was chosen for TPs 1 and 2 to introduce, provoke thought and stimulate the cadets' interest in learner needs.

An in-class activity was chosen for TPs 3 and 4 as it is an interactive way to provoke thought and stimulate interest in the different types of learners and how to meet their needs.

INTRODUCTION

REVIEW

Nil.

OBJECTIVES

By the end of this lesson the cadets shall have described how developmental periods and learning styles determine learner needs.

IMPORTANCE

Instructors must develop an appreciation for all learning styles in order to meet learner needs. Being aware of developmental periods will provide instructors with the necessary tools to plan relevant and meaningful lessons.

Teaching Point 1**Describe the importance of making material relevant and meaningful, and providing information processing time.**

Time: 5 min

Method: Interactive Lecture



Display the slide of Tiger Comic located at Attachment A to focus the cadets' thoughts toward the learning process.

Learning is a complex process. There are many theories about how learning occurs. Determining what is relevant is the first step to ensure that the learning is meaningful. Understanding the age appropriate learning categories provides some insight into how the brain is working to process information.

RELEVANT LEARNING

Relevant. Determining why and if the material is necessary to know. Once this is determined the learner decides whether or not they engage in committing the information to memory.



Albert Einstein said, "Everything should be made as simple as possible, but not simpler."

In other words, teach to the level of the cadets. The level of difficulty determines whether or not the cadets engage in the lesson. Essentially, less is more when it comes to new material.

MEANINGFUL LEARNING

Providing meaningful and relevant material results in greater overall retention.

Learning becomes meaningful when cadets understand material and store it in the brain. A learning experience is meaningful when the learners engage in three processes:

1. reflecting upon prior knowledge;
2. relating to real-life experiences; and
3. applying knowledge in future experiences.

Retention is the ability to remember material after the material is presented. The more information is repeated, the better the retention. Most scientists believe that the pruning is guided both by genetics and by a use-it-or-lose-it principle.



Display the following on flip chart paper / white board.

Learners retain:

- 10% of what they read,
- 26% of what they hear,
- 30% of what they see,
- 50% of what they see and hear,
- 70% of what they say, and
- 90% of what they say and do.

Information is stored in different places in the brain depending on the type of information. Emotions have a great influence on learning. The stronger the emotions connected with an experience, the stronger the memory.

Various types of information are associated with a specific type of memory (as illustrated in Figure 1).

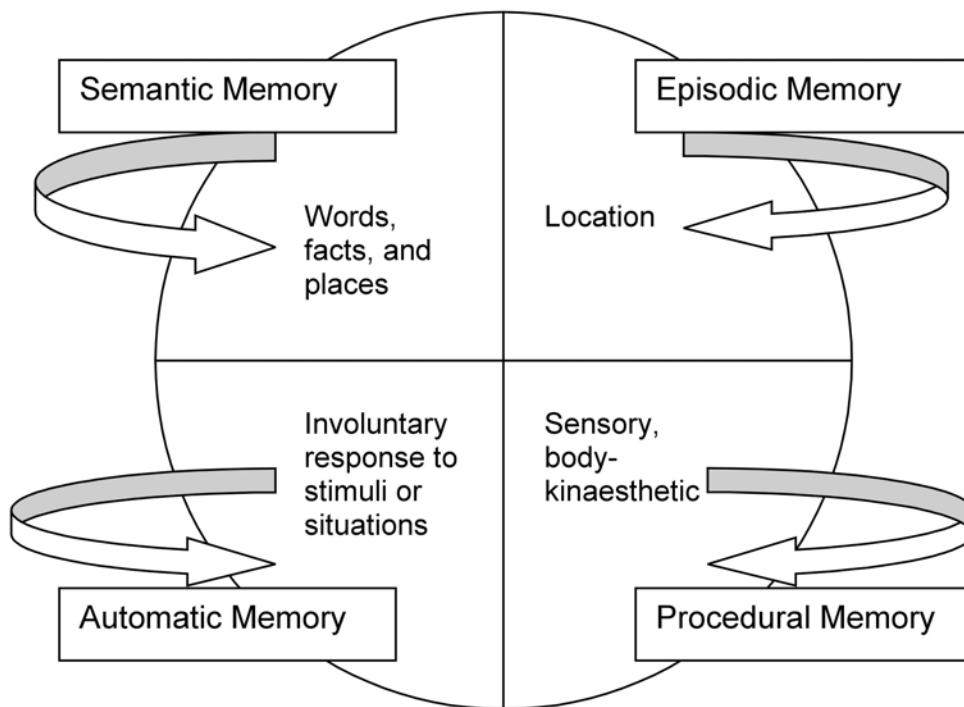

Figure 1 Types of Memory

Note: Created by Director Cadets 3, 2009, Ottawa, ON: Department of National Defence.

PROCESSING TIME

Attention span. The average attention span is about one minute per year of age to a maximum of 15 years.

Allowing time for cadets to apply their learning is important so they can move information from their working memory to their long-term memory. The processing time is known as "thinking about thinking", where cadets can reflect on the lesson and plan, monitor, and evaluate their own thinking and learning.



Distribute the Learning Pyramid located at Attachment B to show the relationship between learning and remembering.

CONFIRMATION OF TEACHING POINT 1

QUESTIONS:

- Q1. What does relevant mean?
- Q2. What three processes involve the learner to have a meaningful learning experience?
- Q3. What is retention? How is it increased?

ANTICIPATED ANSWERS:

- A1. Determining why and if the material is necessary to know. Once this is determined the learner will decide whether or not they will engage in actually committing the information to memory.
- A2. The learner actively:
 - a. reflects upon prior knowledge;
 - b. relates to real-life experiences; and
 - c. applies knowledge in future experiences.
- A3. Retention is the ability to remember material after it is presented. The more information is repeated, the better the retention.

Teaching Point 2

Describe and identify the needs of the developmental periods (DP).

Time: 10 min

Method: Interactive Lecture

DESCRIBE DEVELOPMENTAL PERIODS (DP)

The mental, physical, emotional and social development of a cadet are considered when determining a DP. They are age-based and focus on refining higher-level thinking skills such as reasoning, reflective thinking, and problem solving. The three are also known as age-appropriate learning categories (as illustrated in Figure 2).

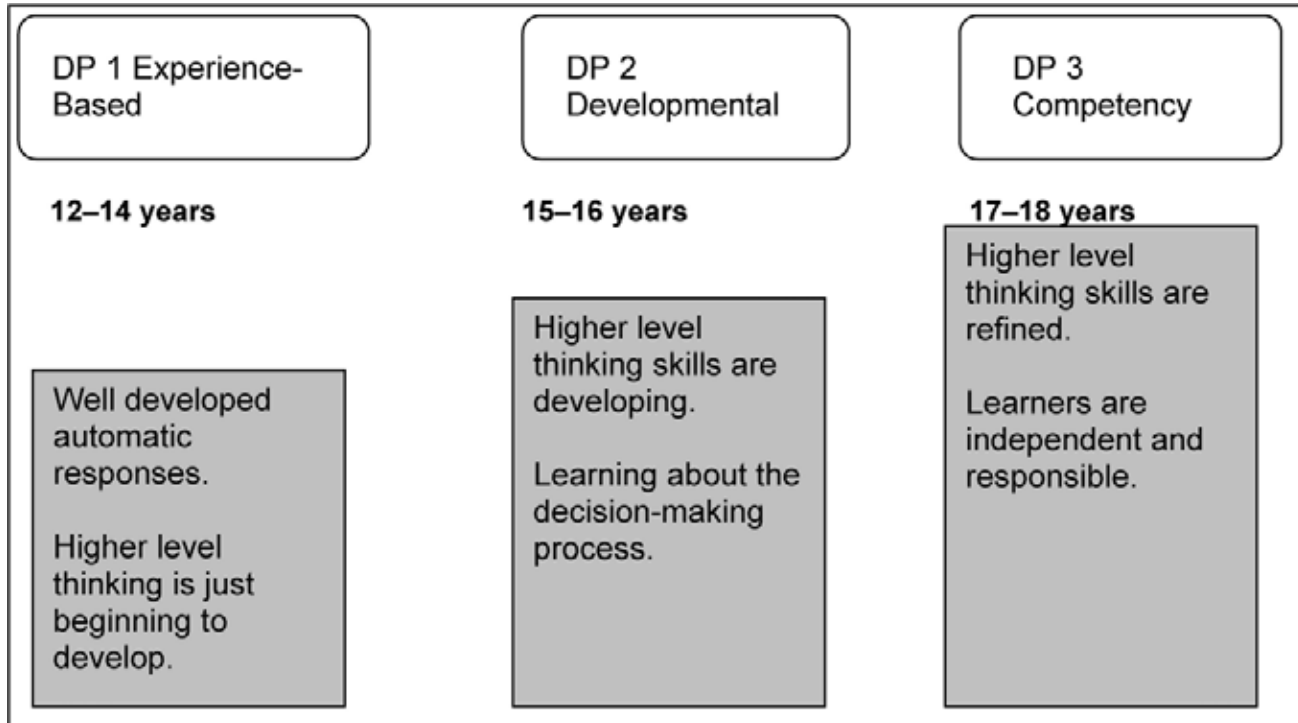



Figure 2 Identifying DPs

Note: Created by Director Cadets 3, 2009, Ottawa, ON: Department of National Defence.

An instructor must plan their lessons based on the DP of the cadets. When planning a lesson it is important to consider what type of activities and questions to ask. For example, each DP indicates how long an activity should last:

- **DP 1.** Activities in a lesson should end in that same lesson.
- **DP 2.** Activities started in a lesson may extend over two to three lessons.
- **DP 3.** Activities started in a lesson may extend over four or more lessons.

NEEDS OF DPs



The following information focuses on DPs 1 and 2 only since the cadets will not be planning lessons for cadets in DP 3.

Experienced-based DP 1 (12–14 years):

- understand what is concrete / real not abstract;
- have mastered reflexive responses;
- require close supervision;
- want interaction and activity in lessons; and
- are very "me" oriented.

Developmental DP 2 (15–16 years):

- in a transition period—moving from understanding the concrete to understanding the abstract;
- beginning to use higher level thinking skills and are comfortable with the concrete;
- want to practice and explore new thinking skills;
- begin to understand cause and effect relationships;
- concerned with fairness—value system kicks in—need for equality for all; and
- asking questions like "how do I fit in?" and "how does this affect me?"

Four areas to consider when teaching within these DPs are:

- active and interactive lessons,
- structured activities,
- the opportunity for choice within the lesson, and
- goals definition.

Each area varies from low to high depending on the age and DP. However, active and interactive lessons are emphasized in all three DPs.

Lessons are planned by incorporating criteria based on the DPs (as illustrated in Figure 3).

Criteria for Activities	Experience-Based	Developmental	Competency
Active and Interactive	yes	yes	yes
Structured	very	some	cadet-run and supervised by officers
Provide Choice	minimal	some	much
Goals	clear and concrete	clear	abstract

Figure 3 Needs for Developmental Periods

Note: Created by Director Cadets 3, 2009, Ottawa, ON: Department of National Defence.

ACTIVITY

Time: 5 min

OBJECTIVE

The objective of this activity is to have the cadets describe and identify the DPs.

RESOURCES

Developmental Periods Confirmation strips located at Attachment C.

ACTIVITY LAYOUT

Nil.

ACTIVITY INSTRUCTIONS

1. Distribute the strips of paper from Attachment C to the cadets.



There are only 10 strips. If there are more than 10 cadets they may work in pairs / groups. If there are less than 10 cadets, some cadets may have more than one strip.

2. Ask the cadets who have a DP to come forward and tape their strip on the board.
3. Ask each cadet to read each strip to the class and decide what DP it describes. If the cadet is having difficulty, other cadets may help.
4. Once a decision has been made, tape the strip under the respective category.

CONFIRMATION OF TEACHING POINT 2

The cadets' participation in the activity will serve as the confirmation of this TP.

Teaching Point 3

Conduct an activity where the cadets will describe and identify the needs of the different learning styles.

Time: 20 min

Method: In-Class Activity

ACTIVITY

OBJECTIVE

The objective of this activity is to have the cadets describe and identify the needs of learners.

RESOURCES

- Learning Styles Information Sheet located at Attachment D,
- Learning Styles Survey located at Attachment E,
- How to Make a Jumping Frog located at Attachment F,
- How to Make a Triangular Box located at Attachment G,
- Slide of *Schoolies* comic located at Attachment H,
- Letter size paper for each cadet,
- Square sized sticky notes (eg, size 3 inches by 3 inches), and
- Sticky notes—4 inches by 6 inches.



In this lesson, sticky notes are used instead of origami paper (which is optimal). However, if sticky notes are not available, cut any paper according to the sizes recommended above.

ACTIVITY LAYOUT

Nil.

ACTIVITY INSTRUCTIONS

1. Distribute the Learning Styles Information Sheet located at Attachment D. Read through the handout together.
2. Distribute the Learning Style Survey located at Attachment E. Have the cadets read each question and choose the most appropriate answer. Once they have answered all questions, have the cadets total each letter to determine their individual learning style.
3. Designate three areas of the classroom to represent each learning style: visual, kinaesthetic, and auditory. Have the cadets move to the group that reflects their learning style as indicated in the survey.



The groups should be uneven. Compare class results with the distribution of learning style percentage as indicated in the Learning Styles Information Sheet located at Attachment D.

4. Have the cadets return to their seats.
5. Distribute a piece of letter size paper, three square sticky notes, and one 4 inch by 6 inch sticky note to each cadet.



The activities are intended to allow the cadets to experience difficulty while using each one of the learning styles. Emphasis is on the cadets experiencing each learning style and not the completion of each activity. It is not important for the cadets to complete each activity, since they are for initial experiences only. Allot 2–3 minutes for each activity.

6. Have the cadets experience the auditory learning style by:
 - a. listening to the directions to make a paper object;
 - b. performing the direction as it is said; and
 - c. refraining from asking questions as the directions are being given.

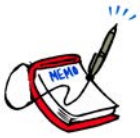

For this activity, have the cadets use the letter size paper. Read the following directions aloud to the cadets on how to make a paper boat:

1. Fold a piece of paper in half, from top to bottom.
2. Fold the right corner into the middle of the paper.
3. Fold the left corner into the middle of the paper.
4. Fold the bottom of the paper up against both sides.
5. Insert thumbs into the bottom to make a square.
6. Fold the bottom corners over each other to create a triangle.
7. Insert thumbs into the bottom to make a square.
8. Hold the paper with flaps down.
9. Fold the corners to the top point.
10. Pull the middle out to form a square.
11. Pull the two triangles at the top apart to create a boat.



For the next activity, have the cadets use the 4 inch by 6 inch sticky notes. Distribute How to Make a Jumping Frog located at Attachment F to each cadet.

7. Have the cadets experience the visual learning style by:
 - a. seeing pictures to make a jumping frog;
 - b. reading the directions to make a jumping frog; and
 - c. performing the task without assistance.



For the next activity, have the cadets use the square sticky note. Use How to Make a Triangular Box located at Attachment G and demonstrate each step so the cadets can see.

8. Have the cadets experience the kinaesthetic learning style by:
 - a. watching the instructor make a triangle box without verbal or written directions, and
 - b. performing the task without assistance.
9. Discuss the cadets' feelings towards each of the learning styles by provoking these thoughts:
 - a. What learning style was dominant in each of the activities?
 - b. What task was most difficult?
 - c. What task was the easiest?



Display the slide of *Schoolies* comic located at Attachment H.

CONFIRMATION OF TEACHING POINT 3

The cadets' participation in the activity will serve as the confirmation of this TP.

Teaching Point 4

Conduct an activity where the cadets will identify how to structure a lesson to meet the needs of the different types of learners.

Time: 15 min

Method: In-Class Activity

ACTIVITY

OBJECTIVE

The objective of this activity is to have the cadets identify how to structure a lesson to meet the needs of types of learners.

RESOURCES

- Instructor Tips for Learning Styles worksheet located at Attachment I,
- Instructor Tips for Learning Styles Answer Key located at Attachment J,
- Activities in Developmental Periods worksheet located at Attachment K,
- Activities in Developmental Periods Answer Key located at Attachment L,
- Flip chart paper,
- Stopwatch,
- Markers, and
- Pens / pencils.

ACTIVITY LAYOUT

Set up workstations by taping flip chart paper around the classroom.



The number of workstations can be determined by dividing the class number by two or four. For example, if the class size is small divide by two, and if it is large divide by four.

ACTIVITY INSTRUCTIONS

1. Divide the cadets into two groups by assigning each cadet a number: Number 1 or Number 2. Arrange the cadets so that each group is sitting on opposite sides of the classroom.

2. Distribute the Instructor Teaching Tips for Learning Styles worksheet located at Attachment I to the cadets in Group 1 and the Activities in Developmental Periods worksheet located at Attachment K to Group 2.
3. Have the cadets work in their groups to fill out their worksheets.



Allocate two minutes for the cadets to work on the worksheets. It is not important to fully complete the sheets.

4. Distribute the answer keys located at Attachments J and L to one cadet in each group.
5. Have the cadet with the answer key in the each group read out the correct answers while the other cadets mark their worksheets and fill in any missing answers.
6. Have the cadets pair up with a cadet from the other side of the classroom and move to one of the workstations.



When the class size is large, two pairs can be assigned to each work station.

7. Give the cadets 2–3 minutes to explain on the chart paper how a DP 1 lesson would be structured differently than a DP 2 lesson. The cadets may use ideas from the worksheets and handouts in the class.
8. Have each group discuss their ideas for 2–3 minutes.



Distribute the remaining copies of Attachments I and K to those cadets that did not receive them earlier in the activity.

SAFETY

Nil.

CONFIRMATION OF TEACHING POINT 4

The cadets' participation in the activity will serve as the confirmation of this TP.

END OF LESSON CONFIRMATION

The cadets' participation in the in-class activities will serve as the confirmation of this lesson.

CONCLUSION

HOMEWORK / READING / PRACTICE

Nil.

METHOD OF EVALUATION

This EO is assessed IAW A-CR-CCP-804/PG-001, *Proficiency Level Four Qualification Standard Plan*, Chapter 3, Annex B, 409 PC.

CLOSING STATEMENT

Understanding what makes information relevant and meaningful is important when it comes to instructing. Defining learning styles and identifying developmental stages helps identify instructional strategies that will meet the learners' needs and ultimately provide them with a healthy and welcoming learning environment.

INSTRUCTOR NOTES / REMARKS

Nil.

REFERENCES

A0-118 Director Cadets 3. (2007). *Youth reference guide*. Ottawa, ON: Department of National Defence.

C0-397 Belding, S. (2004). *Stickiness: Skills retention and synthesis*. Retrieved March 23, 2009, from http://www.airs.org/files/public/Making_Training_Stick.pdf

C0-398 ISBN I-57517-344-1 Burke, K. (2000). *What to do with the kid who....* Arlington Heights, IL: Skylight Professional Development.

THIS PAGE INTENTIONALLY LEFT BLANK

TIGER COMIC



Figure A-1 Hide and Seek

Note. From *Tiger Comics* by B. Blake. Retrieved March 10, 2009, from <http://www.kingfeatures.com/features/comics/tiger/about.html>

THIS PAGE INTENTIONALLY LEFT BLANK

LEARNING PYRAMID

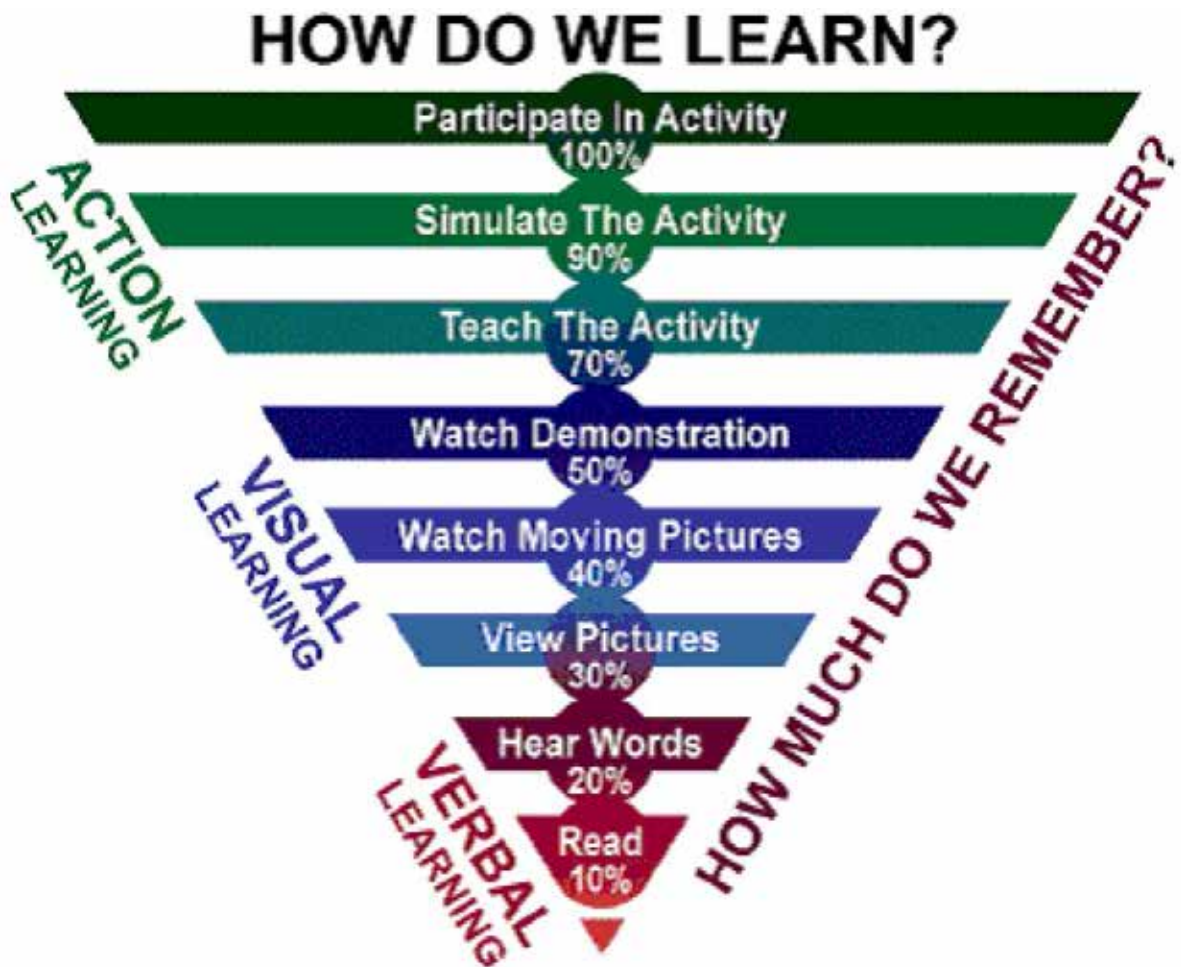

Figure B-1 Learning Pyramid

Note. From *Engage Educate Empower*, 2007, Copyright by Life Adventure Centre 2009. Retrieved March 11, 2009, from <http://www.lifeadventure center.org>

THIS PAGE INTENTIONALLY LEFT BLANK

DEVELOPMENTAL PERIODS CONFIRMATION

Cut out each strip and place in an envelope. Use page C-3 as a reference during the activity.

12–14 years Experience-Based

Effective learning experiences for cadets at this stage should be achievable, active and fun.

It is important to note that these cadets are just developing the area of the brain associated with higher level thinking skills.

Require close supervision.

Activities in the lesson should end in the same lesson.

DEVELOPMENTAL PERIODS CONFIRMATION

Cut out each strip and place in an envelope. Use page C-3 as a reference during the activity.

15–16 years Developmental

Cadets in this stage are ready to start learning about and practising reasoning and problem-solving skills.

Cadets want to practise and explore new thinking skills

Concerned with fairness; the value system kicks in where they need equality for all.

Cadets ask question like "how do I fit in?" and "how does this affect me?"

DEVELOPMENTAL PERIODS CONFIRMATION ANSWER KEY

12–14 years Experience-Based

Effective learning experiences for cadets at this stage should be achievable, active and fun.

It is important to note that these cadets are just developing the area of the brain associated with higher level thinking skills.

Require close supervision.

Activities in the lesson should end in the same lesson.

15–16 years Developmental

Cadets in this stage are ready to start learning about and practising reasoning and problem-solving skills.

Cadets want to practise and explore new thinking skills

Concerned with fairness; the value system kicks in where they need equality for all.

Cadets ask question like "how do I fit in?" and "how does this affect me?"

THIS PAGE INTENTIONALLY LEFT BLANK

LEARNING STYLES INFORMATION SHEET

Understanding the different learning styles can help make a more effective instructor. For example, being aware of how cadets process information allows the instructor to design lessons and activities that present information in a variety of ways to address as many learning styles as possible. Learning occurs using the senses. The three learning styles use seeing, hearing and touching. Seeing corresponds to visual learners, hearing corresponds to auditory learners and touching corresponds to kinaesthetic learners.

Visual Learners: <ul style="list-style-type: none"> • are described as readers and observers; • learn through seeing; • think in pictures; • benefit from and enjoy visual aids; and • are better at reading than listening. 	Auditory Learners: <ul style="list-style-type: none"> • are described as listeners and talkers; • process information through their ears; • are good working in louder environments; • are great socialisers; and • need to ask questions to confirm learning. 	Kinaesthetic Learners: <ul style="list-style-type: none"> • are described as doers; • learn through moving, touching and doing; • process information through their muscles; and • learn best when combining muscles with reading or talking.
--	--	--

Figure D-1 Learning Styles

Note. Adapted from *Cadet Program Reference Guide*. Created by Director Cadets 3, 2009, Ottawa, ON: Department of National Defence.

The differences between the three learning styles are illustrated in Figure D-2.

	VISUAL	AUDITORY	KINAESTHETIC
Decision Making	Create a chart of the possible alternatives; write out pros / con.	Talk over options with a friend.	Try out options—go with the path that seems best.
Asking Directions	Prefer a map / written directions.	Prefer verbal instructions.	Prefer to have someone take them the first time.
Learning a New Skill	Watch someone else do it, follow a diagram in a manual.	Attend a lecture; have someone talk them through the steps.	Try this and that until it works.

Figure D-2 Learning Styles and Instructional Activities

Note. From *Cognitive Preference*. Retrieved March 10, 2009, from <http://www.georgebrown.ca/saffairs/stucuss/learningstyles.aspx>.

To process information, a combination of the three senses are used, signifying that no learning style is completely independent. Each individual has a dominant learning style that represents how they process information most / how they learn best. Most of the population learn best by seeing and are therefore visual learners. When preparing a lesson, the instructor must keep in mind that it is best to provide multiple opportunities for all three styles of learning.

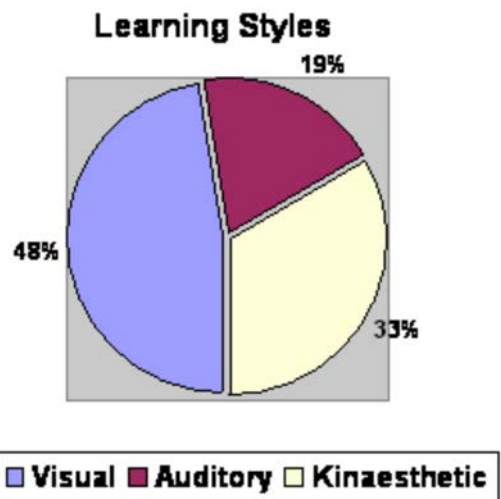

Figure D-3 Dominant Learning Style

Note. Adapted from *Cadet Program Reference Guide*. Created by Director Cadets 3, 2009, Ottawa, ON: Department of National Defence.

LEARNING STYLES SURVEY

Directions. Select the answer that describes you best. There can only be one answer for each question. Once all the questions are answered, tally each of the letters, V, A and K to find your learning style.

1. If I have to learn how to do something, I learn best when I:

- (V) watch someone show me how.
- (A) hear someone tell me how.
- (K) try to do it myself.

2. When I read, I often find that I:

- (V) visualize what I am reading in my mind's eye.
- (A) read aloud or hear the words inside my head.
- (K) fidget and try to "feel" the content.

3. When asked to give directions, I:

- (V) see the actual places in my mind as I say them or prefer to draw them.
- (A) have no difficulty in giving them verbally.
- (K) have to point or move my body as I give them.

4. If I am unsure how to spell a word, I:

- (V) write it in order to determine if it looks right.
- (A) spell it out loud in order to determine if it sounds right.
- (K) write it in order to determine if it feels right.

5. When I write, I:

- (V) am concerned with how neat and well spaced my letters and words appear.
- (A) often say the letters and words to myself.
- (K) push hard on my pen or pencil and can feel the flow of the words or letters as I form them.

6. If I had to remember a list of items, I would remember it best if I:

- (V) wrote them down.
- (A) said them over and over to myself.
- (K) moved around and used my fingers to name each item.

7. I prefer teachers who:

- (V) use the board or overhead projector while they lecture.
- (A) talk with a lot of expression.
- (K) use hands-on activities.

8. When trying to concentrate, I have a difficult time when:

- (V) there is a lot of clutter or movement in the room.
- (A) there is a lot of noise in the room.
- (K) I have to sit still for any length of time.

9. When solving a problem, I:

- (V) write or draw diagrams to see it.
- (A) talk myself through it.
- (K) use my entire body or move objects to help me think.

10. When given written instructions on how to build something, I:

- (V) read them silently and try to visualize how the parts will fit together.
- (A) read them out loud and talk to myself as I put the parts together.
- (K) try to put the parts together first and read later.

11. To keep occupied while waiting, I:

- (V) look around, stare, or read.
- (A) talk or listen to others.
- (K) walk around, manipulate things with my hands, or move / shake **my feet as I sit**.

12. If I had to verbally describe something to another person, I would:

- (V) be brief because I do not like to talk at length.
- (A) go into great detail because I like to talk.
- (K) gesture and move around while talking.

13. If someone were verbally describing something to me, I would:

- (V) try to visualize what they were saying.
- (A) enjoy listening but want to interrupt and talk myself.
- (K) become bored if their description got too long and detailed.

14. When trying to recall names, I remember:

- (V) faces but forget names.
- (A) names but forget faces.
- (K) the situation that I met the person other than the person's name or face.

Scoring Instructions: Add the number of responses for each letter and enter the total below. The area with the highest number of responses is your primary style of learning.

Visual V = _____ Auditory A = _____ Kinaesthetic K = _____

Figure E-1 Survey

Note. From *Learning Styles*. Retrieved March 16, 2009, from <http://www.georgebrown.ca/saffairs/stusucc/learningstyles.aspx>

HOW TO MAKE A JUMPING FROG

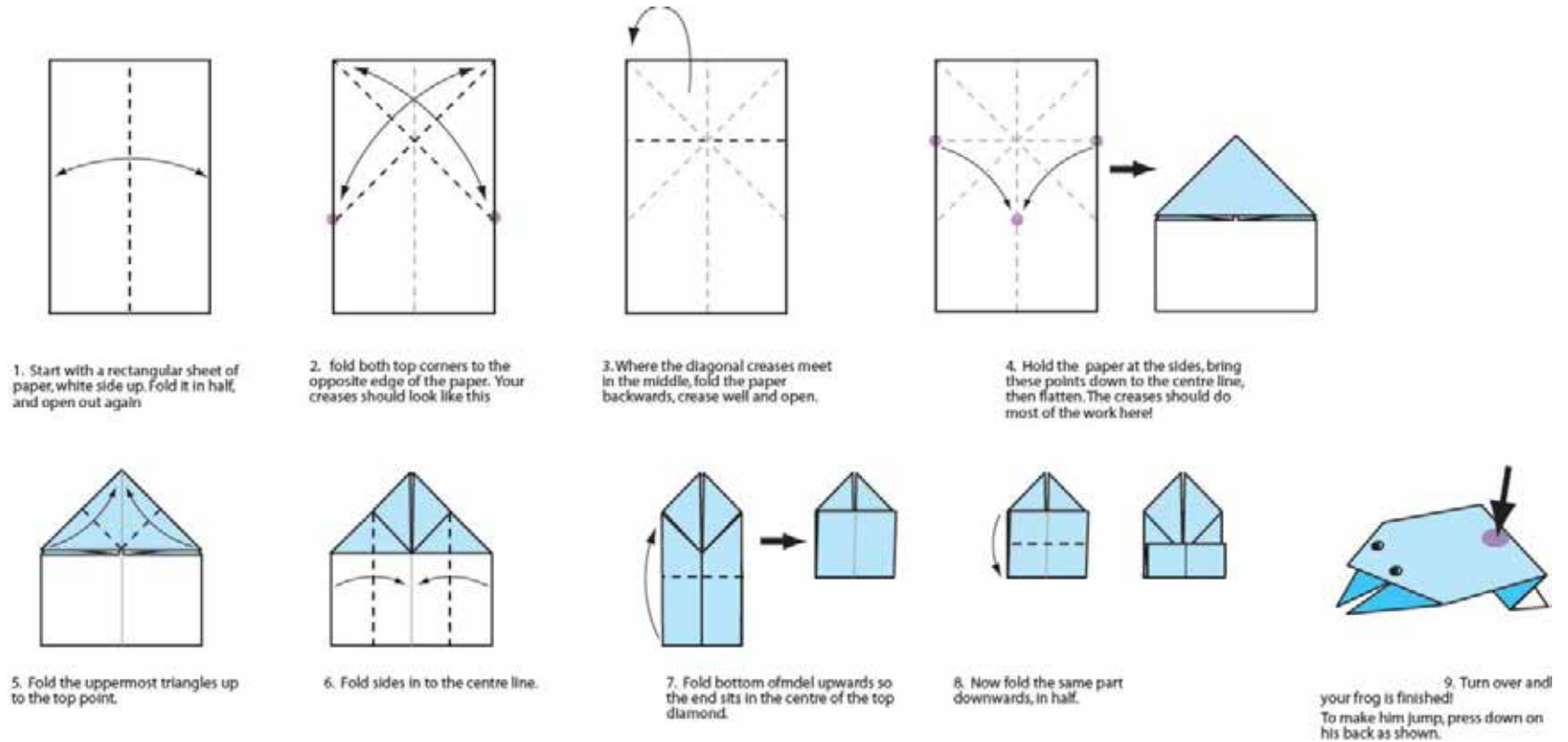

Figure F-1 Jumping Frog

Note. From *Origami-Fun*. Retrieved March 10, 2009, from <http://www.origami-fun.com>

THIS PAGE INTENTIONALLY LEFT BLANK

HOW TO MAKE A TRIANGULAR BOX

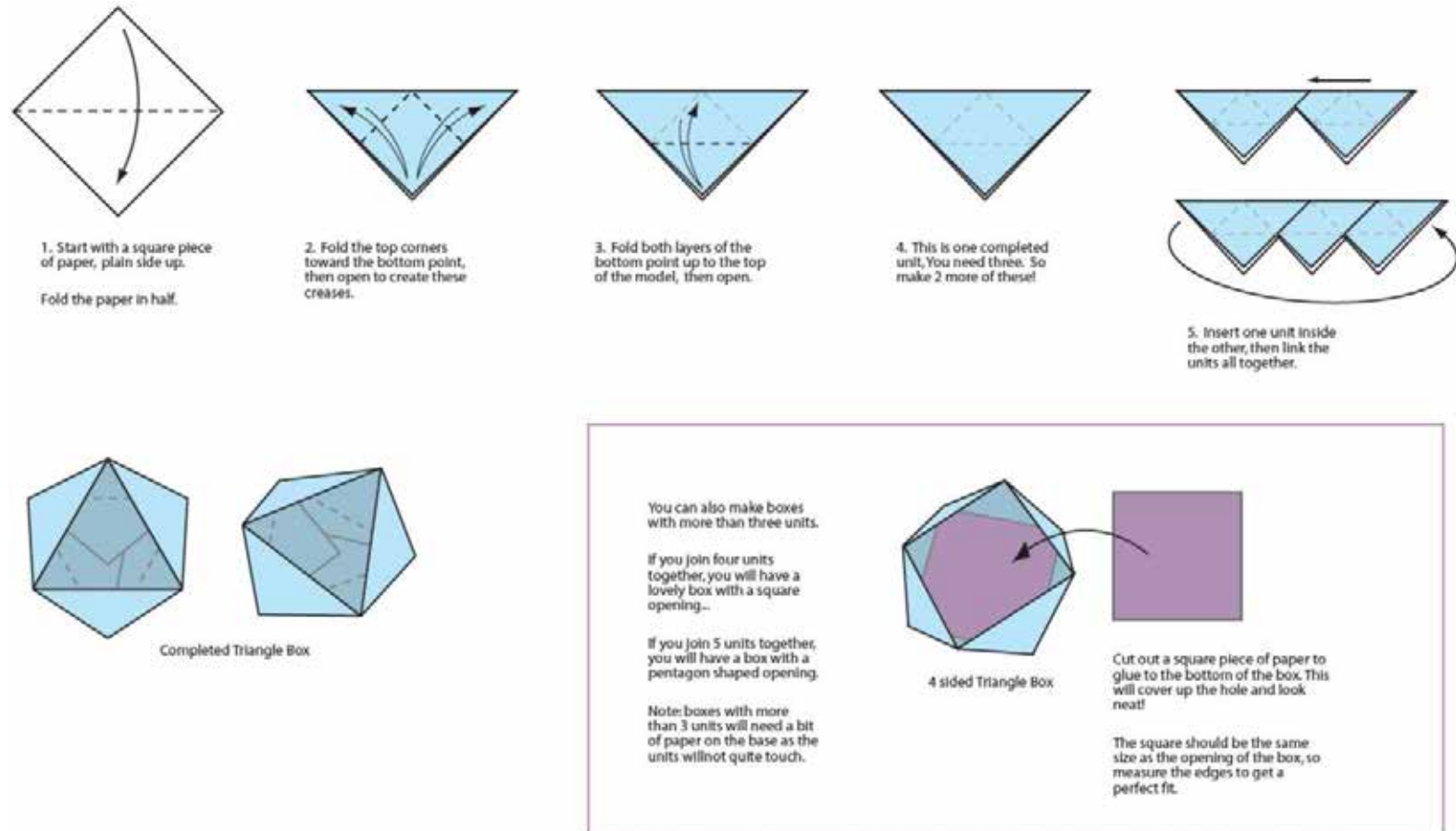

Figure G-1 Triangular Box

Note. From *Origami-Fun*. Retrieved March 10, 2009, from <http://www.origami-fun.com>

THIS PAGE INTENTIONALLY LEFT BLANK

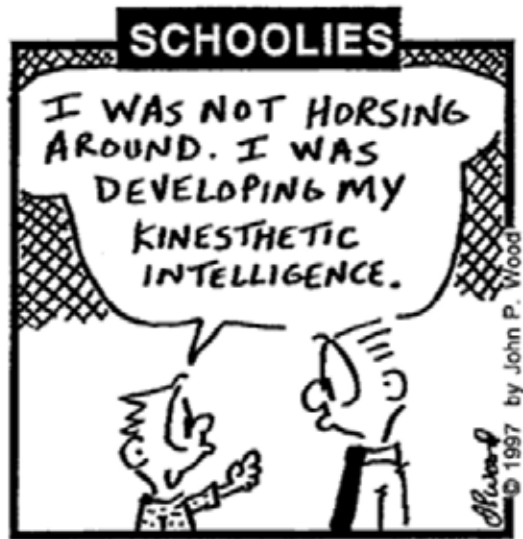

Figure H-1 Kinesthetic Learning

Note. From *Schoolies*, 1997, Copyright 1997 by J. Wood. Retrieved from <http://www.learninglaffs.com>

THIS PAGE INTENTIONALLY LEFT BLANK

INSTRUCTOR TIPS FOR LEARNING STYLES

Directions: Match each instructor tip with the correct learning style. Use V for Visual, A for Auditory, and K for Kinaesthetic.

1. ____ Allow cadets to sit where they can see clearly.
2. ____ Allow the cadets to get up and move.
3. ____ Use hands-on activities.
4. ____ Provide movement as part of the lesson.
5. ____ Buddy up to teach each other.
6. ____ Use items that can be handled and moved.
7. ____ Allow the cadets to sit where they can hear clearly.
8. ____ Read aloud written material.
9. ____ Keep visual aids in view long enough to be seen and referred back to.
10. ____ Use presentations, mutuels and speeches.
11. ____ Follow a written agenda and provide written material to be followed.
12. ____ Write out directions.
13. ____ Provide a space where they can read questions aloud to themselves before they write them down.
14. ____ Allow the cadets to do what is asked for, not to describe it.
15. ____ Provide discussion opportunities.
16. ____ Use rhymes, mnemonics and acronyms.
17. ____ Slow down and repeat when giving verbal information.
18. ____ Change pitch, tone and speed for emphasis.
19. ____ Avoid meaningless movement and decorations.
20. ____ Use posters, pictures, models, real items, and people.
21. ____ Have the cadets repeat things back.
22. ____ Use real items in context.
23. ____ Provide a space with few distractions.
24. ____ Allow matching or reorganizing rather than naming.
25. ____ Slow down, repeat and use only necessary words when asking verbal questions.
26. ____ Provide opportunity for written responses.
27. ____ Provide space to move around.
28. ____ Provide opportunity for verbal responses.
29. ____ Allow them to talk to themselves and whisper when they read.

THIS PAGE INTENTIONALLY LEFT BLANK

INSTRUCTOR TIPS FOR LEARNING STYLES ANSWER KEY

Directions: Match each instructor tip with the correct learning style. Use V for Visual, A for Auditory, and K for Kinaesthetic.

1. V Allow cadets to sit where they can see clearly.
2. K Allow the cadets to get up and move.
3. K Use hands-on activities.
4. K Provide movement as part of the lesson.
5. A Buddy up to teach each other.
6. K Use items that can be handled and moved.
7. A Allow the cadets to sit where they can hear clearly.
8. A Read aloud written material.
9. V Keep visual aids in view long enough to be seen and referred back to.
10. A Use presentations, mutuels and speeches.
11. V Follow a written agenda and provide written material to be followed.
12. V Write out directions.
13. A Provide a space where they can read questions aloud to themselves before they write them down.
14. K Allow the cadets to do what is asked for, not to describe it.
15. A Provide discussion opportunities.
16. A Use rhymes, mnemonics and acronyms.
17. V Slow down and repeat when giving verbal information.
18. A Change pitch, tone and speed for emphasis.
19. V Avoid meaningless movement and decorations.
20. V Use posters, pictures, models, real items, and people.
21. A Have the cadets repeat things back.
22. K Use real items in context.
23. V Provide a space with few distractions.
24. K Allow matching or reorganizing rather than naming.
25. V Slow down, repeat and use only necessary words when asking verbal questions.
26. A Provide opportunity for written responses.
27. K Provide space to move around.
28. A Provide opportunity for verbal responses.
29. A Allow them to talk to themselves and whisper when they read.

THIS PAGE INTENTIONALLY LEFT BLANK

ACTIVITIES IN DEVELOPMENTAL PERIODS

Read each statement and determine what developmental period is being described. Draw an arrow to the correct column.

Ages 12–14	Activity Description	Ages 15–16
DP 1 Experienced-Based		DP 2 Developmental
	Clear / simple processes.	
	Provide reasons for the activity.	
	Provide some structure (eg, the instructor chooses the groups but leaves some choices to the group).	
	Closely supervised.	
	Semi-independent and less supervised.	
	Clear goals with some choice in process.	
	Very structured.	
	Lots of play.	
	Trial and error activities.	
	Clear and concrete goals (eg, one goal / one activity).	
	Provide reasons for the activity.	
	Will not require an instant result at the end of the first session. Can stretch the activity over 2–3 lessons.	
	Results oriented.	
	Formal, effective assessment is appropriate. Begin to develop skills in self assessment.	
	Assessment should focus on participation and observation.	
	Short learning sessions.	

THIS PAGE INTENTIONALLY LEFT BLANK

ACTIVITIES IN DEVELOPMENTAL PERIODS ANSWER KEY

Read each statement and determine what developmental period is being described. Draw an arrow to the correct column.

Ages 12–14	Activity Description	Ages 15–16
DP 1 Experienced-Based		DP 2 Developmental
←	Clear / simple processes.	
	Provide reasons for the activity.	→
	Provide some structure (eg, the instructor chooses the groups but leaves some choices to the group).	→
←	Closely supervised.	
	Semi-independent and less supervised.	→
	Clear goals with some choice in process.	→
←	Very structured.	
←	Lots of play.	
←	Trial and error activities.	
←	Clear and concrete goals (eg, one goal / one activity).	
	Provide reasons for the activity.	→
	Will not require an instant result at the end of the first session. Can stretch the activity over 2–3 lessons.	→
←	Results oriented.	
	Formal, effective assessment is appropriate. Begin to develop skills in self assessment.	→
←	Assessment should focus on participation and observation.	
←	Short learning sessions.	

THIS PAGE INTENTIONALLY LEFT BLANK



**COMMON TRAINING
PROFICIENCY LEVEL FOUR
INSTRUCTIONAL GUIDE**



SECTION 4

EO M409.04 – EXPLAIN ASSESSMENT

Total Time:

30 min

PREPARATION

PRE-LESSON INSTRUCTIONS

Resources needed for the delivery of this lesson are listed in the lesson specification located in A-CR-CCP-804/PG-001, *Proficiency Level Four Qualification Standard and Plan*, Chapter 4. Specific uses for said resources are identified throughout the instructional guide within the TP for which they are required.

Review the lesson content and become familiar with the material prior to delivering the lesson.

PRE-LESSON ASSIGNMENT

Photocopy the Assessment of Learning Plan located at Attachment A for each cadet.

Photocopy the Assessment Instructions located at Attachment B for each cadet.

Photocopy the assessment instruments located at Attachments C, D and E for each cadet.

APPROACH

An interactive lecture was chosen for this lesson as a way to introduce the cadets to assessment types, instructions and instruments, provoke thought and stimulate interest among cadets.

INTRODUCTION

REVIEW

Nil.

OBJECTIVES

By the end of this lesson the cadet shall have explained assessment.

IMPORTANCE

It is important for cadets to know the different types of assessment and how to use assessment tools to create a positive learning environment. Varying the method of assessment is one way for instructors to create interest and encourage learning.

Teaching Point 1**Explain types of assessment.**

Time: 10 min

Method: Interactive Lecture

ASSESSMENT OF LEARNING

Assessment of learning is the predominant type of assessment used following instruction / learning. It is a summative type of assessment that is used to report on progress made by cadets, usually by showing the instructor a cadet's relative position compared to other cadets. Assessment of learning usually takes the form of questions and answers compiled in a test or quiz. The questions are from the lesson that was taught and typically performed at the end of an instruction unit.

Tests are used to measure quantity and accuracy of student progress with little or no direction and advice for improvement. This type of testing shows which students are doing well and which are doing poorly. Although these testing techniques are simplistic, they can be a good indication of a cadet's mastery of skills and knowledge. They are not always a good indication of the ideas or concepts covered.

Within the Canadian Cadet Organization (CCO), assessment of learning takes place to determine whether learners have achieved Performance Objectives (PO) or critical Enabling Objectives (EO) (those deemed prerequisites for further training and education) and are used at the end of a phase of instruction. Every opportunity should be given to cadets to be successful in their assessment, even if multiple challenges are required.

ASSESSMENT FOR LEARNING

Assessment for learning is ongoing assessment used during instruction. It is a formative type of assessment and is used to create descriptions of the cadet's knowledge on the subject matter. These descriptions are used to determine if the instructor needs to review information and where the weak areas are in the lesson. This information can also be used to provide feedback to the cadet regarding their strengths and areas for improvement.

Assessment instruments used during assessment for learning include:

- worksheets,
- checklists,
- in-class activities, and
- questions and observations.

In assessment for learning, the instructor is the central character that will use the information obtained to design and develop the next stage of instruction.

Within the CCO, assessment for learning takes place during a phase of instruction and helps cadets and instructors recognize progress or lapses in learning. Through assessment for learning, the instructor can:

- identify when corrective or remedial action is required;
- plan the next steps in instruction;
- provide cadets with feedback so they can improve; and
- reinforce learning to aid the cadet in retaining information.

Assessment for learning may also include opportunities for cadets to practice using Performance Checks (PC) employed in assessment of learning.



A simple comparison of assessment types can be made as follows:

When a cook tastes the soup, that is formative (assessment for) and allows them to adjust spices to change the flavour to improve the taste; when the guests taste the soup, that is summative (assessment of) and allows them to make a judgement of the quality of the soup.

CONFIRMATION OF TEACHING POINT 1

QUESTIONS:

- Q1. What type of assessment is assessment for learning?
- Q2. What does assessment for learning (formative) give the instructor the ability to do?
- Q3. Why does assessment of learning (summative) take place?

ANTICIPATED ANSWERS:

- A1. Formative.
- A2. Identify when corrective or remedial action is required, plan the next steps in instruction, provide cadets with feedback so they can improve, and reinforce learning to aid the cadet in retaining information.
- A3. To determine whether learners have achieved POs or critical EOs (those deemed prerequisites for further training and education).

Teaching Point 2

Describe assessment instructions and instruments.

Time: 15 min

Method: Interactive Lecture

Assessment for learning takes place throughout the learning process and guides the instructor in lesson planning; assessment of learning takes place upon completion of the learning phase. Chapter 3 of the Qualification Standard and Plan (QSP) outlines the assessment of learning plan and the assessment instruments to be used.



All attachments for this lesson are taken from A-CR-CCP-803/PG-001, *Proficiency Level Three Qualification Standard and Plan*, Chapter 3. Details of assessment are located in Chapter 3 of all QSPs.

CADET ASSESSMENT OF LEARNING PLAN



Distribute the Assessment of Learning Plan located at Attachment A to each cadet.

The Assessment of Learning Plan located at Chapter 3, Annex B of the QSP, provides an overall strategy for using assessment activities to determine if the cadet has met the requirements for qualification. The assessment of learning plan will:

1. provide an outline of each assessment of learning activity including its purpose, when it will occur and details the assessment instrument(s) used to support cadet evaluation;
2. identify the learning target(s) associated with the PO and / or EO being assessed, to include:
 - a. **Knowledge Mastery.** The facts, concepts and theory a cadet needs to know;
 - b. **Reasoning Proficiency.** A cadet uses what they know to solve a problem, make a decision, make a plan, think critically, set goals, or self-assess;
 - c. **Skills.** Performance demonstration where the cadet demonstrates their ability to perform a skill. To be assessed, these performances must be demonstrated by the cadet and observed by an assessor;
 - d. **Ability to Create Products.** A cadet uses their knowledge, reasoning and skills to create a concrete product; and / or
 - e. **Attitudinal / Dispositional Changes.** A cadet's attitude about learning, safety, conduct, etc. Targets in this realm reflect attitude and feeling. They represent important affective goals we hold for a cadet as a by-product of their CP experience, and as such are not generally assessed for the purpose of attaining a qualification.
3. identify the assessment method(s) that best matches PO and / or EO learning targets, to include:
 - a. **Selected Response.** A cadet selects the correct or best response from a list provided. Formats include multiple choice, true / false, matching, short answer, and fill-in-the-blank questions. Although short answer and fill-in-the-blank questions do require cadets to generate an answer, they call for a very brief answer that is counted as right or wrong, so these have been included in the selected response category;
 - b. **Extended Written Response.** A cadet is required to construct a written answer in response to a question or task rather than select one from a list. An extended written response is one that is at least several sentences in length;
 - c. **Performance Assessment.** This assessment method is based on observation and judgment; performance or product is observed and a determination is made as to its quality; and / or
 - d. **Personal Communication.** Gathering information about a cadet through personal communication; learning is assessed through interpersonal interaction with the cadet.

ASSESSMENT INSTRUMENTS

Specific assessment instruments are designed to support each assessment activity within the assessment of learning plan. These are meant to standardize assessment activities and cadet evaluation for all cadets attempting the qualification. Assessment instruments are located at the appendices to Chapter 3, Annex B of the QSP.



Distribute the Assessment Instructions located at Attachment B to each cadet.

Assessment instructions are provided to guide the instructor through the steps of the assessment to ensure consistent conduct of all assessments.



Using the Assessment Instructions handout, discuss with the cadets the information located in it, to include:

- preparation,
- conduct of assessment, and
- post-assessment instructions.



Distribute the assessment instruments located at Attachments C, D and E to each cadet. Discuss with the cadets how to use each of these assessment instruments.

Assessment is conducted to ascertain levels of learning. In most cases, these levels are defined in the Assessment Instructions. The most common assessment instruments used in the CCO are rubrics, individual checklists, and group checklists.

Rubric. A scoring tool that lists criteria to be considered for assessment. It is designed to guide the individual assessor's interpretation by providing a description of what should be observed for each level of proficiency and should be as clear and concise as practical.

Checklists. A simple checkbox type of worksheet that shows success in given tasks. Checklists can be designed to assess both individuals or groups.

CONFIRMATION OF TEACHING POINT 2

QUESTIONS:

- Q1. What does the Assessment of Learning Plan provide?
- Q2. What are the three parts of the Assessment Instructions?
- Q3. What is a rubric?

ANTICIPATED ANSWERS:

- A1. An overall strategy for using assessment activities to determine if the cadet meets the requirements.
- A2. Preparation, conduct of assessment and post-assessment instructions.
- A3. A scoring tool that lists criteria to be considered for assessment. It is designed to guide the individual assessor's interpretation by providing a description of what should be observed for each level of proficiency and should be as clear and concise as practical.

END OF LESSON CONFIRMATION**QUESTIONS:**

- Q1. Where in the QSP can information on assessment be found?
- Q2. When does assessment for learning (formative assessment) take place?
- Q3. What is the purpose of the Assessment Instructions?

ANTICIPATED ANSWERS:

- A1. In Chapter 3 of the QSP.
- A2. Ongoing throughout the lesson.
- A3. To guide the instructor through the steps of the assessment to ensure consistent conduct of all assessments.

CONCLUSION

HOMEWORK / READING / PRACTICE

Nil.

METHOD OF EVALUATION

This EO is assessed IAW A-CR-CCP-804/PG-001, *Proficiency Level Four Qualification Standard and Plan*, Chapter 3, Annex B, 409 PC.

CLOSING STATEMENT

Being familiar with assessment requirements will allow the instructor to be better prepared to meet the requirements of the lesson.

INSTRUCTOR NOTES / REMARKS

Nil.

REFERENCES

A3-191 A-CR-CCP-803/PG-001 Director Cadets 3. (2008). *Proficiency level three qualification standard and plan*. Ottawa, ON: Department of National Defence.

C0-376 ISBN 0-7619-4626-8 Earl, L. (2003). *Assessment as learning*. Thousand Oaks, CA: Corwin Press, Inc.

Annex B

Assessment of Learning Plan – Proficiency Level Three

EC / PC	Scope	Purpose	Target	Method	How	When	Resources	Limitations
<i>PO 301 – Recognize the Purpose of Service Groups Within Canada</i>								
Nil.								
<i>PO 302 – Perform Community Service</i>								
Nil.								
<i>PO 303 – Perform the Role of a Team Leader</i>								
303 PC	PO 303	To assess the cadet's ability to perform the role of a team leader.	Reasoning Proficiency and Skills	Performance Assessment and Personal Communication	The cadet is observed performing the role of a team leader. The performance is then discussed with the cadet.	On completion of lessons related to EO M303.07 then ongoing throughout the training year.	Chapter 3, Annex B, Appendix 1 checklist and associated rubric.	Nil.
<i>PO 304 – Update Personal Activity Plan</i>								
Nil.								
<i>PO 305 – Participate in Recreational Sports</i>								
Nil.								
<i>PO 306 – Fire the Cadet Air Rifle During Recreational Marksmanship</i>								
Nil.								
<i>PO 307 – Serve in an Air Cadet Squadron</i>								
Nil.								

EC / PC	Scope	Purpose	Target	Method	How	When	Resources	Limitations
<i>PO 308 – Direct a Squad Prior to a Parade</i>								
308 PC	PO 308	To assess the cadet's ability to prepare a squad for parade.	Skills	Performance Assessment	The cadet is observed as they prepare a squad for parade by: forming up, sizing, dressing, inspecting and calling the roll.	During preparation for squadron opening and closing parades.	Chapter 3, Annex B, Appendix 2 checklist.	Nil
<i>PO 309 – Instruct a Lesson</i>								
309 PC	PO 309	To assess the cadet's ability to instruct a lesson using a written lesson plan, an appropriate method(s) of instruction and an appropriate instructional aid(s).	Product and Reasoning Proficiency	Performance Assessment	The cadet's lesson plan is reviewed and they are observed while instructing a 15-minute lesson.	Ongoing during the conduct of lessons related to EO M309.07	Chapter 3, Annex B, Appendix 3 checklist and rubric	Assistance is denied.
<i>PO 311 – Participate in a Recreational Biathlon Activity</i>								
Nil.								
<i>PO 320 – Participate in Canadian Forces (CF) Familiarization Activities</i>								
Nil.								

EC / PC	Scope	Purpose	Target	Method	How	When	Resources	Limitations
<i>POs 331/336/337 (Aviation Subjects) – Combined Assessment</i>								
M331 M336 M337 PC	PO 331 PO 336 PO 337	To assess the cadets' ability to master knowledge of aviation subjects.	Knowledge Mastery	Selected Response	The cadet will write a performance check.	At or near the end of the training year.	Chapter 3, Annex B, Appendix 4 Written Test.	No assistance will be given.
<i>PO 340 – Identify Aspects of Space Exploration</i>								
Nil.								
<i>PO 360 – Recognize Aspects of Aerodrome Operations</i>								
Nil.								
<i>PO 370 – Recognize Aspects of Aircraft Manufacturing and Maintenance</i>								
Nil.								
<i>PO 390 – Navigate a Route Using a Map and Compass</i>								
M390 PC	PO 390	To assess the cadet's ability to navigate a route using a map and compass.	Skills	Performance Assessment	The cadet is observed as they perform the various skills to navigate a route using a map and a compass	After completion of instruction and during a filed exercise.	Chapter 3, Annex B, Appendix 5 checklist and associated rubric.	No assistance will be given.

THIS PAGE INTENTIONALLY LEFT BLANK

ANNEX B, APPENDIX 1
303 PC
ASSESSMENT INSTRUCTIONS

PREPARATION

PRE-ASSESSMENT INSTRUCTIONS

Review the assessment plan, assessment instructions and 303 PC Assessment Rubric and become familiar with the material prior to conducting the assessment.

There is no time allotted for 303 PC. It is to be administered whenever and wherever Phase Three cadets lead cadets through a leadership assignment.

The cadet shall be given a minimum of one practice leadership assignment which will be assessed using the 303 PC Assessment Rubric. The cadet will reflect and self-assess after the practice leadership assignment using the same rubric. The practice leadership assignment will not be recorded on the cadet's qualification record.

The formal leadership assignment will be given and assessed using the 303 PC Assessment Rubric. The cadet will reflect and self-assess after the leadership assignment using the same rubric. The leadership assignment shall be recorded on the cadet's qualification record.

If the cadet does not achieve the performance standard, the cadet will be given additional leadership assignments until the performance standard is met.

Photocopy the 303 PC Assessment Rubric twice for each leadership assignment given.

PRE-ASSESSMENT ASSIGNMENT

The cadet shall review the 303 PC Assessment Rubric and become familiar with the assessment criteria prior to the leadership assignment.

ASSESSMENT METHOD

Performance assessment and personal communication were chosen as it allows the assessor to observe the cadet's ability to perform the required skill(s) and make a judgement on the quality of performance.

CONDUCT OF ASSESSMENT

PURPOSE

The purpose of this PC is to assess the cadet's ability to lead cadets through a leadership assignment.

RESOURCES

- Two 303 PC Assessment Rubrics, and
- As per the leadership assignment.

ASSESSMENT ACTIVITY LAYOUT

As per the leadership assignment.

ASSESSMENT ACTIVITY INSTRUCTIONS



While observing the cadet leading cadets through a leadership assignment, assess the quality of each criterion by indicating (eg, highlighting, circling, note taking) on the Assessment Rubric, the descriptive statement that best represents this judgement. Criteria for the leading through a leadership assignment are assessed as:

- Incomplete;
- Completed with difficulty;
- Completed without difficulty; or
- Exceeded standard.

Make notes of observations to provide descriptive post-assessment feedback.

1. Communicate to the cadet their leadership assignment either verbally or in writing.
2. Ensure the cadet understands the leadership assignment.
3. Distribute the Assessment Rubric to the cadet for self-assessment purposes.
4. Ensure the cadet understands their self-assessment will not be recorded on their qualification record.
5. Have the cadet conduct the leadership assignment.
6. Evaluate the cadet's leadership ability by observation. Record the result (eg, highlighting, circling, note taking) on the Assessment Rubric for each criterion.



The assessment of leadership abilities is subjective; however, the assessor's responsibility is to be as positive as possible.

7. Have the cadet assess their performance on their Assessment Rubric.

POST ASSESSMENT INSTRUCTIONS

RECORDING ASSESSMENT RESULTS

1. Indicate the overall performance assessment on the Assessment Checklist as:
 - a. **Incomplete.** Overall, the cadet has not achieved the performance standard;
 - b. **Completed with difficulty.** Overall, the cadet has achieved the performance standard with difficulty;
 - c. **Completed without difficulty.** Overall, the cadet has achieved the performance standard without difficulty; or
 - d. **Exceeded standard.** Overall, the cadet has exceeded the performance standard.
2. Record notes and observations in the assessor's feedback section of the Assessment Checklist.

3. Sign and date the Assessment Checklist.
4. Ensure a copy of the Assessment Checklist is attached to the cadet's training file.
5. The overall result will be recorded on the Phase Three Qualification Record located at Chapter 3, Annex C.

PROVIDING ASSESSMENT FEEDBACK

Discuss the cadet's self-assessment on their performance.

Ask the cadet what they felt went right during the leadership assessment, what did not go well and ask the cadet how they would improve their performance if the leadership assignment was given to them again.

Discuss the performance results of each section of the Assessment Rubric with the cadet.

Discuss the overall performance results with the cadet and provide the cadet with a copy of the completed rubric.

THIS PAGE INTENTIONALLY LEFT BLANK

303 PC ASSESSMENT RUBRIC

Cadet's Name: _____

Corps: _____

Date: _____

Division: _____

	Incomplete	Completed With Difficulty	Completed Without Difficulty	Exceeded the Standard
Communicate as a team leader.	Did not communicate with team members.	Communicated with team members occasionally. Team members needed clarification on many occasions.	Communicated with team members on many occasions. Team members needed few clarifications.	Communicated to the team throughout the leadership task. Team members did not need clarification.
Supervise cadets.	Did not supervise cadets.	Only supervised cadets at the beginning and / or end of the leadership assignment.	Supervised throughout the leadership assignment making some corrections when necessary.	Supervised throughout the leadership assignment making corrections as necessary.
Solve problems.	Did not solve the problem(s).		Solved the problem(s).	
Complete the leadership assignment.	Did not complete the leadership assignment.		Completed the leadership assignment.	
Perform self-assessment.	Did not complete the self-assessment.		Completed the self-assessment.	

This form shall be reproduced locally.

THIS PAGE INTENTIONALLY LEFT BLANK

308 PC ASSESSMENT CHECKLIST

Cadet's Name: _____

Corps: _____

Date: _____

Division: _____

Analytical Performance Assessment:

Direct a squad prior to a parade			
	Incomplete	Completed With Difficulty	Completed Without Difficulty
Fall in a squad.			
Call the roll.			
Size in a single rank and reform in threes (twos).			
Dress a squad.			
Inspect a squad.			
Hand over a squad.			

Assessor's Feedback

PO 308 Overall Assessment				
Check One	Incomplete	Completed With Difficulty	Completed Without Difficulty	Exceeded Standard
Overall Performance	The cadet has not achieved the performance standard by not completing at least one of the required skills.	The cadet has achieved the performance standard by completing one or more of the required objectives with difficulty.	The cadet has achieved the performance standard by completing all objectives without difficulty.	N/A

Assessor's Name:	Position:
Assessor's Signature:	Date:

This form shall be reproduced locally.

THIS PAGE INTENTIONALLY LEFT BLANK

390 PC ASSESSMENT CHECKLIST

Cadet's Name: _____

Other Group Member: _____

Assessor: _____

<i>Performance Assessment:</i>			Assessment	
Skill Group	Task		Incomplete	Completed
Grid References (GRs)	Determine six-figure GR for each of the three points marked on the map.	#1		
		#2		
		#3		
	Plot each of the three 6-figure GR, from the worksheet on the map.	#1		
		#2		
		#3		

Determining Distance and Pacing	Determine distance for each of the six legs (within 50 m).	#1		
		#2		
		#3		
		#4		
		#5		
		#6		
	Calculate distance into paces for each of the six legs.	#1		
		#2		
		#3		
		#4		
		#5		
		#6		
	Use a method to keep track of pace count for each of the three legs.	#1		
		#2		
		#3		
	Bypass obstacles using pacing techniques (observed for each of the three legs).	#1		
		#2		
		#3		
Find marker within 10 percent of calculated pace count for each of the three legs.	#1			
	#2			
	#3			

Skill Group	Task	Incomplete	Completed	
Bearings	Check magnetic declination setting on the compass.			
	Determine bearing for each of the six legs from a map (within two degrees).	#1		
		#2		
		#3		
		#4		
		#5		
		#6		
	Set compass (within two degrees) of bearing for each of the three legs.	#1		
		#2		
		#3		
	Determine direction of travel (within five degrees) for each of the three legs using a compass.	#1		
		#2		
		#3		
	Determine a steering point for each of the three legs.	#1		
		#2		
		#3		
	Re-check, for each of the three legs (minimum once each leg), direction of travel using a compass.	#1		
		#2		
		#3		
	Re-check, for each of the three legs (minimum once each leg), direction of travel using the determined steering point.	#1		
		#2		
		#3		
	Find marker within a 20-m radius for each of the three legs.	#1		
		#2		
#3				

Incomplete	The task was not attempted or not completed despite being provided assistance.
Completed	The task was completed without difficulty or with difficulty / assistance.

Overall Performance Assessment:	PO Assessment	
PO 390 PC	Incomplete	Completed
Participate in Ground Navigation.		

Incomplete	If over 40 percent (over 21) of the tasks are assessed as incomplete.
Completed	If 60 percent and over (31 and over) of the tasks are assessed as completed.

Assessor's Feedback:

Assessor's Signature: _____

Date: _____

This form shall be reproduced locally.

SAMPLE ASSESSMENT ACTIVITY

Sample Map

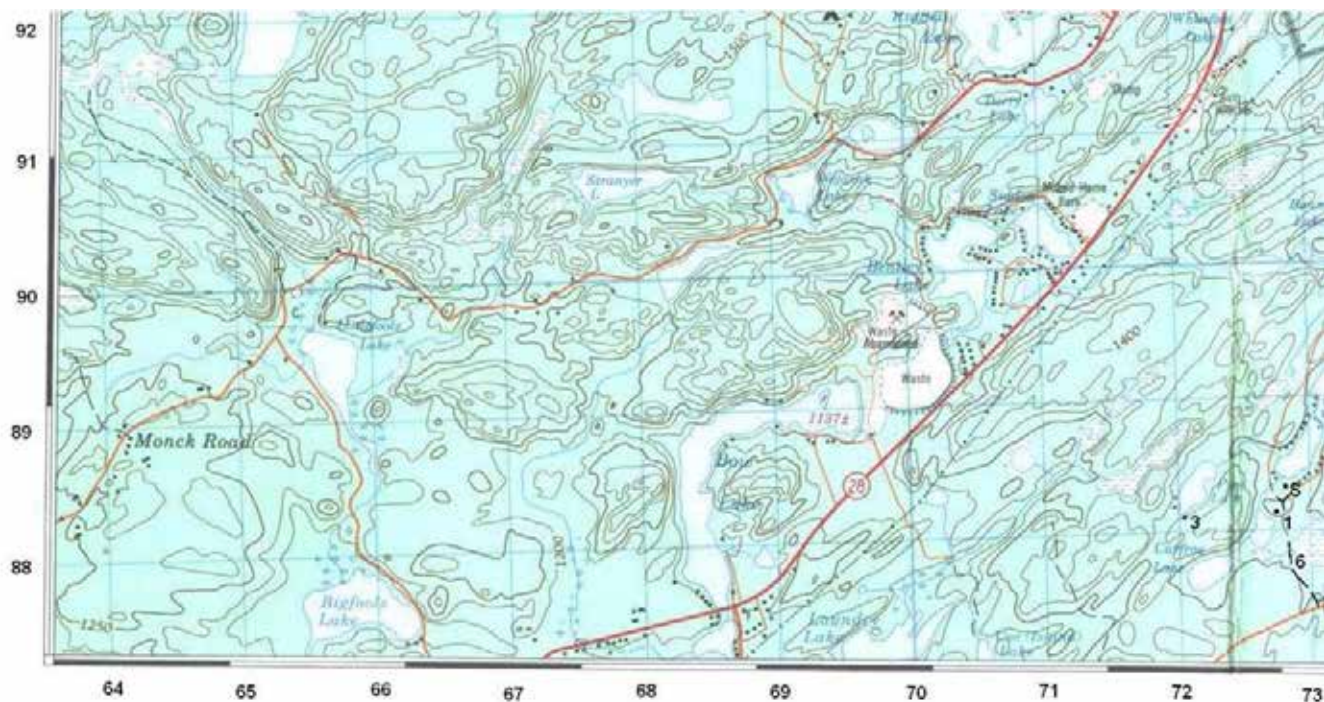

Figure B5-1 Assessment Activity Map

Note. From *Bancroft 31 F/4*, Canada Centre for Mapping, 1996, Ottawa, ON: Natural Resources Canada. Copyright 1996 by Her Majesty the Queen in Right of Canada.



All points are located in the lower left-hand corner. To clearly identify the designated points and terrain features, Figure B5-1 is best viewed in colour.

The cadets will be given a compass, map, worksheet and access to a calculator. The map has been marked with the start point, "S" and the three other points, "1", "3", and "6", for which to determine six-figure GRs. The other three points, for legs two, four and five, will be marked on the map by the cadet from the six-figure GRs on the worksheet. All seven points have a descriptive word or phrase to help identify it. The cadets will complete the worksheet then move on to the course to complete three legs each. When the course has been completed, the cadets will do a self-assessment with their assessor and receive a copy of their Assessment Checklist by the next parade night.

A sample and completed worksheet are shown as examples for this sample assessment activity. The blank worksheet may be used as a template.

Cadet Worksheet (sample)

Name: _____

Personal Pace: _____

#	GR	Distance		Bearing	Description
		m	paces		
S	728883			X	most southerly cabin on Jeffrey Lake
1					cabin by vehicle track fork
2	722882				shore of Pipe Lake near the "L" of lake
3					most southerly cabin on Pipe Lake
4	720878				shore of Carfrae Lake near the "e" of lake
5	723873				hill south of Carfrae Lake
6					vehicle track crossing creek south of cabin

Magnetic Declination: 11° west declination

Safety Bearing: 120°

Will lead to either a gravel road or a vehicle trail; wait at the side of the road / trail for the safety vehicle.

Calculations:

Cadet Worksheet (completed sample):

Name: _____ F/Cpl Boggins _____

Personal Pace: _____ 140 _____

#	GR	Distance		Bearing	Description
		m	paces		
S	728883			X	most southerly cabin on Jeffrey Lake
1	727881	200	280	199°	cabin by vehicle track fork
2	722882	500	700	282°	shore of Pipe Lake near the "L" of lake
3	720881	200	280	230°	most southerly cabin on Pipe Lake
4	720878	450	630	180°	shore of Carfrae Lake near the "e" of lake
5	723873	450	630	154°	hill south of Carfrae Lake
6	728878	800	1120	44°	vehicle track crossing creek

Magnetic Declination: 11° west declination

Safety Bearing: 120°

Will lead to either a gravel road or a vehicle trail; wait at the side of the road / trail for the safety vehicle.

Calculations:

Cadet Worksheet

Name: _____

Personal Pace: _____

#	GR	Distance		Bearing	Description
		m	paces		
S				X	
1					
2					
3					
4					
5					
6					

Magnetic Declination:

Safety Bearing:

Calculations:

This form shall be reproduced locally.



**COMMON TRAINING
PROFICIENCY LEVEL FOUR
INSTRUCTIONAL GUIDE**



SECTION 5

EO M409.05 – INSTRUCT A 30-MINUTE LESSON

Total Time:

90 min

THERE IS NO INSTRUCTIONAL GUIDE PROVIDED FOR THIS EO

THIS PAGE INTENTIONALLY LEFT BLANK



**COMMON TRAINING
PROFICIENCY LEVEL FOUR
INSTRUCTIONAL GUIDE**



SECTION 6

EO C409.01 – PLAN A LESSON

Total Time:

60 min

THERE IS NO INSTRUCTIONAL GUIDE PROVIDED FOR THIS EO

THIS PAGE INTENTIONALLY LEFT BLANK



**COMMON TRAINING
PROFICIENCY LEVEL FOUR
INSTRUCTIONAL GUIDE**



SECTION 7

EO C409.02 – INSTRUCT A 30-MINUTE LESSON

Total Time:

90 min

THERE IS NO INSTRUCTIONAL GUIDE PROVIDED FOR THIS EO

THIS PAGE INTENTIONALLY LEFT BLANK



**COMMON TRAINING
PROFICIENCY LEVEL FOUR
INSTRUCTIONAL GUIDE**



SECTION 8

EO C409.03 – ACT AS AN ASSISTANT INSTRUCTOR

Total Time:

90 min

PREPARATION

PRE-LESSON INSTRUCTIONS

Resources needed for the delivery of this lesson are listed in the lesson specification located in A-CR-CCP-804/PG-001, *Proficiency Level Four Qualification Standard and Plan*, Chapter 4. Specific uses for said resources are identified throughout the instructional guide within the TP for which they are required.

Review the lesson content and become familiar with the material prior to delivering the lesson.

The course officer shall communicate with the training officer to ensure that cadets are paired with a Proficiency Level One, Two or Three instructor during a regular training session. As part of the training session, the instructor and cadet should be scheduled for two periods of instruction. The time the cadet is not instructing may be used for lesson preparation, briefing, debriefing, securing training aids, etc.

A number of factors may exist based on the size of the squadrons that will not allow for all Proficiency Level Four cadets to be scheduled for this EO at the same time. In this circumstance, special consideration should be given to minimize the cadet's absence from other areas of training. For example, scheduling half of the cadets for this EO while the other half is scheduled for EO C440.02 (Launch a Small Model Rocket) and reversing the schedule for the following training session.

PRE-LESSON ASSIGNMENT

Nil.

APPROACH

OJT was chosen for this lesson as it allows the cadets to assist instructing a lesson in a safe and controlled environment. The OJT experience provides the cadets a practical application of learned skills in a realistic setting. The cadets reflect on the experience and receives feedback on the performance, which helps to shape future experiences. The cadets develop a sense of responsibility from the OJT aiding their development as a leader.

INTRODUCTION

REVIEW

Nil.

OBJECTIVES

By the end of this lesson the cadet shall have acted as an assistant instructor.

IMPORTANCE

It is important for cadets to act as an assistant instructor as it gives them the opportunity to practice, observe and assist in performing the duties of an instructor in a safe and controlled environment during a regular training session.

Teaching Point 1**Have the cadets act as assistant instructors in on-the-job training (OJT).**

Time: 90 min

Method: On-The-Job Training

PURPOSE

The purpose of having the cadets act as assistant instructors is to provide them with an authentic experience that allows them to observe and assist in performing the duties of an instructor during a regular training session. This activity is intended to be experiential in nature, providing the cadets the opportunity to work with experienced instructors, with assessment for learning being the focus rather than assessment of learning. When pairing the cadets with an instructor, consideration must be given to such things as the background, specialty and confidence of each cadet while in front of a class. The proper pairing of cadets with an instructor will help to ensure the OJT experience satisfies the stated purpose.

GENERAL INSTRUCTIONS

For one training session the cadets shall be paired with an instructor who is instructing a group of cadets participating in Proficiency Level One, Two or Three training.

The instructor is responsible for the following:

1. Ensure the cadet is briefed on their responsibilities and tasks prior to the commencement of the lesson.
2. Ensure the cadet is provided opportunities to perform some or all tasks normally completed by the instructor, such as:
 - a. **Preparing training aids as required.** The cadet may be asked to gather and prepare training aids.



The focus of this EO should be the development of instructional skills and increasing experience and confidence while in front of a class. The instructor should develop training aids for the lesson. Give the cadet tasks such as setting up presentation aids and organizing training aids, eg, signing out an air rifle for a marksmanship lesson.

- b. **Helping instruct the lesson.** The cadet may be asked to provide a demonstration, assist with the conduct of an in-class activity or instruct a TP of a lesson.
 - c. **Supervising the cadets.** The cadet may be asked to assist with the supervision of the cadets.
 - d. **Providing assistance as required.** The cadet may be asked to provide assistance or assist with skill development by coaching or demonstrating a skill being taught.
 - e. **Securing training aids as required.** Once the lesson is complete, the cadet may be asked to secure and return training aids to storage.
3. If necessary, debrief the (Proficiency Level One, Proficiency Level Two or Proficiency Level Three) cadets, correcting any content errors or omissions made by the cadet.
4. Debrief the cadet upon completion of the training session and provide them the opportunity to ask questions and seek additional feedback.

CONFIRMATION OF TEACHING POINT 1

The cadets' acting as an assistant instructor will serve as the confirmation of this TP.

END OF LESSON CONFIRMATION

The cadets' acting as an assistant instructor will serve as the confirmation of this lesson.

CONCLUSION

HOMEWORK / READING / PRACTICE

Nil.

METHOD OF EVALUATION

Nil.

CLOSING STATEMENT

Acting as an assistant instructor allows for the development of skills necessary to become a competent instructor by observing, practicing instruction and receiving feedback from an experienced instructor in a safe and controlled environment during a regular training session.

INSTRUCTOR NOTES / REMARKS

Prior to this EO, the course officer shall communicate with the training officer to ensure that cadets are paired with a Proficiency Level One, Two or Three instructor for a regular training session.

A number of factors may exist based on the size of the squadron that will not allow for all Proficiency Level Four cadets to be scheduled for this EO at the same time. In this circumstance, special consideration should be given to minimize the cadet's absence from other areas of training. For example, scheduling half of the cadets for this EO while the other half is scheduled for EO C440.02 (Launch a Small Model Rocket) and reversing the schedule for the following training session.

During this EO the instructor shall:

1. brief the cadet prior to commencing the lesson;
2. assign the cadet tasks, to include:
 - a. preparing training aids as required;
 - b. helping instruct the lesson;
 - c. supervising the cadets;
 - d. providing assistance as required; and
 - e. securing training aids as required;
3. monitor the cadet; and
4. debrief the cadet at the end of the lesson.

REFERENCES

Nil.



**COMMON TRAINING
PROFICIENCY LEVEL FOUR
INSTRUCTIONAL GUIDE**



SECTION 9

EO C409.04 – PARTICIPATE IN A CREATIVE LESSON-PLANNING WORKSHOP

Total Time:

90 min

PREPARATION

PRE-LESSON INSTRUCTIONS

Resources needed for the delivery of this lesson are listed in the lesson specification located in A-CR-CCP-604/PG-001, *Phase Four Qualification Standard and Plan*, Chapter 4. Specific uses for said resources are identified throughout the instructional guide within the TP for which they are required.

Review the lesson content and become familiar with the material prior to delivering the lesson.

Photocopy Attachments A–C.

Photocopy and three-hole punch the handouts located at Attachments E–G, J and M for each cadet.

Photocopy Attachment K for each group.

Photocopy and cut out the Benefits of Creative Lessons Strips located at Attachment I for each group.

Photocopy a sample lesson plan (from Phase One) for each group.

Prepare a piece of flip chart paper by writing the goals of the workshop:

1. define creativity;
2. identify the benefits of a creative lesson;
3. explain the creative process; and
4. incorporate creativity in the lesson-planning process.

Select music to play in the background for the entire workshop.

PRE-LESSON ASSIGNMENT

Ensure the cadets bring the binder provided in EO M409.01 (Identify Methods of Instruction).

APPROACH

An in-class activity was chosen for this lesson as it is an interactive way to provoke thought and stimulate interest in the creative process and how to incorporate creativity into the lesson-planning process.

INTRODUCTION

REVIEW

Nil.

OBJECTIVES

By the end of this lesson the cadet shall have participated in a creative lesson-planning workshop to define creativity, identify the benefits of creative lessons, explain the creative process and learn how to incorporate creative elements into lesson plans.

IMPORTANCE

It is important for cadets to incorporate creative elements into their lesson plans to make their lessons more interesting, enjoyable and engaging for the cadets.

Teaching Point 1**Conduct an activity where the cadets will define creativity.**

Time: 15 min

Method: In-Class Activity

ACTIVITY**OBJECTIVE**

The objective of this activity is to have the cadets define creativity.

RESOURCES

- Mixer worksheet located at Attachment A,
- Picture This... worksheet located at Attachment B,
- Cliche Stretching worksheet located at Attachment C,
- Mixer Answer Key located at Attachment D,
- Flip chart paper,
- Markers, and
- Stereo.

ACTIVITY LAYOUT

1. Set up three workstations.
2. Label the workstations as A, B, and C and place flip chart paper and the corresponding attachments at each station.
3. Ensure the lesson location:
 - a. is physically safe;
 - b. allows for manipulation of the physical setting such as lighting, temperature and colour to make it more conducive to learning;
 - c. is large enough to accommodate small group and whole group activities; and
 - d. allows for the incorporation of movement into the lesson.

ACTIVITY INSTRUCTIONS

1. Divide the cadets into equal groups at each station.



Display the chart paper illustrating the worksheet goals.

2. Introduce the goals of the workshop. Read the goals of the workshop together.
3. Instruct the cadets to work in their groups brainstorming ideas about creativity and write their responses on flip chart paper.

4. Instruct the cadets to follow the directions at their station to complete the activity.



Play music in the classroom while the cadets are completing individual and group work.

5. Provide the cadets with two minutes to present an example of their activity and to explain how their activity was creative. Encourage the cadets to use a visual representation of their activity on flip chart paper.
6. Explain to cadets that:
- thinking creatively does not always make sense; and
 - sometimes the brain must think in different ways to find the answer.
7. Present the cadets with the following problem and answer:
- If you throw a ball as hard as you can, how does it come back to you?
 - It doesn't hit anything, no one catches it, and no one else throws it back.
 - Answer: If you throw the ball up in the air.
8. Provide the cadets with the following definition of creativity:
- Creativity is the combining of elements in a new way.
 - A new idea or product is often a combination of unlike elements previously thought to be completely unrelated.



There are two types of creativity:

- **Technical.** People create new theories, technologies or ideas; and
- **Artistic.** Involves unique methods of self-expression.

Creative people have three qualities:

- an **ability** to imagine relationships between unlike items,
- a **playful attitude** towards new ideas, and
- a **willingness** to work at changing and improving ideas and solutions.

9. Compare the definition with the ideas that the cadets brainstormed on their flip chart paper.

SAFETY

Nil.

CONFIRMATION OF TEACHING POINT 1

The cadets' participation in the activity will serve as the confirmation of this TP.

Teaching Point 2**Have the cadets participate in activities that celebrate and encourage creativity.**

Time: 10 min

Method: In-Class Activity

ACTIVITY**OBJECTIVE**

The objective of this activity is to have the cadets participate in activities that celebrate and encourage creativity.

RESOURCES

- Celebrate Success handout located at Attachment E (one per cadet),
- Flip chart paper, and
- Markers.

ACTIVITY LAYOUT

Nil.

ACTIVITY INSTRUCTIONS

1. Explain to the cadets that upon hearing the attention signal Two Snaps and a Clap, they will:
 - a. repeat the signal immediately by snapping fingers on both hands twice and clapping once;
 - b. stop, look at the instructor and wait for an announcement; and
 - c. carry on when told to do so.
2. Have the cadets practice the two snaps and a clap.
3. Distribute the Celebrate Success handout located at Attachment E to each cadet.
4. Read Attachment E together.

**STIMULATE THE BRAIN TO THINK CREATIVELY**

The right side of the brain is the creative side and the left side of the brain is the mathematical side. One side of the brain usually dominates the other with scientific people having a more dominant left side and artistic people having a more dominant right side.

Creativity can be improved by having both sides of the brain switched on and functioning. The left side of the brain controls the right side of the body and the right side of the brain controls the left side of the body. Physical activity increases oxygen flow to the brain and helps it function better.

5. Divide the cadets into four groups to represent each cheer.
6. Provide the cadets two minutes to practice each cheer.

7. Provide each group one minute each to demonstrate each cheer to the class and have them participate in their cheer after each demonstration.
8. Debrief the cadets by emphasizing the importance for motivation and physical activity in lessons.

SAFETY

Nil.

CONFIRMATION OF TEACHING POINT 2

The cadets' participation in the activity will serve as the confirmation of this TP.

Teaching Point 3

Conduct an activity where the cadets will identify the benefits of a creative lesson.

Time: 15 min

Method: In-Class Activity



Present the following information to the cadets prior to conducting the activity.

The preparation of a well-developed lesson:

- provides structure and organization;
- guides the instructor through each stage of the lesson; and
- ensures that all essential information is delivered.

A well-developed lesson does not ensure the cadet is interested and engaged in the learning process. Well-planned lessons that creatively challenge and involve the cadets in a variety of activities engage the cadets in the learning process and ensure that learning outcomes are achieved.



Ask the cadets to think about a time when they were bored during a lesson and a time when they were interested during a lesson. Have them think about the two experiences as they take part in the brainstorming activity.

ACTIVITY

Time: 10 min

OBJECTIVE

The objective of this activity is to have the cadets identify the benefits of a creative lesson.

RESOURCES

- The Benefits of Creative Lessons handout located at Attachment F
- The Benefits of Creative Lessons Worksheet located at Attachment G,

- The Benefits of Creative Lessons Answer Key located at Attachment H,
- The Benefits of Creative Lessons Phrase Strips located at Attachment I (one set per group),
- Flip chart paper,
- Markers,
- Pencils / pens, and
- Tape.

ACTIVITY LAYOUT

Nil.

ACTIVITY INSTRUCTIONS

1. Divide the cadets into groups of three or four.
2. Distribute the Benefits of Creative Lessons handout located at Attachment F to each cadet and review the handout together.
3. Distribute the Benefits of Creative Lessons worksheet located at Attachment G to each cadet.
4. Give the cadets five minutes to work together to complete the worksheet.
5. After five minutes review the answers using the Benefits of Creative Lessons Answer Key located at Attachment H.
6. Distribute the Strips located at Attachment I, flip chart paper and tape to each group.
7. Have each group divide their sheet of flip chart paper into two columns:
 - a. uncreative lesson, and
 - b. creative lesson.
8. Have each group place each strip in the appropriate column.
9. Review the cadets' posters and debrief the cadets.



All strips are located under the creative lesson column.



Many instructors do not engage cadets because they do not use enough creativity in their teaching. Some aspects of the cadet program are personally interesting to the cadets which helps compensate for this. Some lessons however, are not personally interesting to the cadets and depend more heavily on the instructors' creative ability.

SAFETY

Nil.

CONFIRMATION OF TEACHING POINT 3

The cadets' participation in the activity will serve as the confirmation of this TP.

Teaching Point 4

Conduct an activity where the cadets will identify the stages of the creative process.

Time: 20 min

Method: In-Class Activity



Present the following information to the cadets prior to conducting the activity.

THE CREATIVE PROCESS

A lesson plan is an organized outline for a single period of instruction. It is a necessary guide for instructors because it tells them:

- what to do,
- in what order to do it, and
- what method(s) to use in teaching the material.

Each time an instructor is faced with the challenge of planning a creative lesson they can apply the creative thinking process as outlined below.

ACTIVITY

Time: 15 min

OBJECTIVE

The objective of this activity is to have the cadets participate in the creative process.

RESOURCES

- The Creative Process handout located at Attachment J (one per cadet),
- Forced Analogy worksheet located at Attachment K (one per group),
- Forced Analogy Guide located at Attachment L,
- Empty match box (one per group), and
- HB # 2 pencil (one per group).

ACTIVITY LAYOUT

Nil.

ACTIVITY INSTRUCTIONS

1. Distribute the Creative Process handout located at Attachment J to each cadet.
2. Review the process with the cadets.
3. Distribute an empty matchbox and the Forced Analogy worksheet to each group.
4. Provide five minutes for the groups to compare the matchbox to their local squadron. Guide the groups through this step by offering assistance as required. Encourage them to be creative in their comparison.



Circulate around the room to ensure that the cadets are processing the information. Use Attachment L as a guide to cadets experimenting difficulty.

5. Have the cadets copy their responses in the forced analogy blank template for the matchbox activity.



If groups finish early, they can continue with the second analogy.

- a. Distribute a HB # 2 pencil to each group.
- b. Have the cadets use forced analogy to compare parts of the pencil to the Canadian Cadet Organizations (CCO).
- c. Have the cadets write their responses on the Forced Analogy worksheet.

6. Have each group assign one of its members to share their chart with the whole group.
7. Have the cadets work in their groups and alternately ask the questions from the Forced Analogy worksheet. Allow them to refer to The Creative Process handout located at Attachment J to help answer the questions.

SAFETY

Nil.

CONFIRMATION OF TEACHING POINT 4

The cadets' participation in the activity will serve as the confirmation of this TP.

Teaching Point 5

Conduct an activity where the cadets will incorporate creativity into the lesson-planning process.

Time: 20 min

Method: In-Class Activity



Present the following information to the cadets prior to conducting the activity.

INCORPORATE CREATIVITY INTO A LESSON PLAN

Instructors are constantly challenged to plan lessons that engage cadets in the learning process. Often the only difference between creative and uncreative instructors is self-perception. Creative instructors see themselves as creative and have the confidence to attempt new things. Uncreative instructors do not think about creativity and do not give themselves the opportunity to create anything new.



The first step towards becoming more creative is to relax. It is far more difficult to be creative when the body is tired or stressed. Creativity is found in the subconscious mind which is more accessible in a relaxed state.

To be creative during lesson planning instructors set aside time to examine if there is a better way of instructing a previously taught lesson or to play around with different ways of instructing a new lesson. This process should become a habitual part of the instructor's thinking.

Creative lessons are filled with physical and mental activities that involve all the cadets. The instructor should ensure that the cadets always feel emotionally safe in the learning environment and can take part in all learning activities without fear of being embarrassed, put down or ridiculed. Instructors can do this by:

- showing a positive attitude;
- showing interest in the lesson topic;
- treating cadets respectfully and demanding that cadets treat their peers respectfully;
- challenging cadets with fun activities that are not too easy or too difficult;
- rewarding effort as well as results;
- appealing to different learning styles;
- providing specific feedback;
- encouraging the cadets;
- communicating clear expectations and routines; and
- providing processing time.

ACTIVITY

Time: 15 min

OBJECTIVE

The objective of this activity is to have the cadets incorporate creative elements into the lesson-planning process.

RESOURCES

- Ways to Incorporate Creativity handout located at Attachment M, and
- Sample lesson plan (one per group).



The sample lesson plan can be any lesson plan that has been developed for Phase One training. A sample lesson plan should be developed if none are available.

As an alternative, cadets may use the lesson plan they developed for EO M409.05 (Instruct a 30-Minute Lesson).

ACTIVITY LAYOUT

Nil.

ACTIVITY INSTRUCTIONS

1. Distribute the Ways to Incorporate Creativity handout located at Attachment M and review as a class.
2. Distribute the sample lesson plan to each group.
3. Allow each group 10 minutes to adapt a lesson plan by incorporating some of the creative elements at appropriate places throughout the lesson.
4. Circulate around the room providing assistance as required.
5. Give each group two minutes to present their ideas for their lessons to the class.

SAFETY

Nil.

CONFIRMATION OF TEACHING POINT 5

The cadets' participation in the activity will serve as the confirmation of this TP.

END OF LESSON CONFIRMATION

The cadets' participation in the lesson-planning activity will serve as the confirmation of this lesson.

CONCLUSION

HOMEWORK / READING / PRACTICE

Nil.

METHOD OF EVALUATION

Nil.

CLOSING STATEMENT

Lessons that creatively challenge and involve the cadets in a variety of activities engages them in the learning process and ensure that learning outcomes are achieved.

INSTRUCTOR NOTES / REMARKS

This EO should be scheduled as one training session.

This EO shall be conducted after EO M409.05 (Instruct a 30-Minute Lesson).

REFERENCES

- C0-375 ISBN 978-1-879097-10-0 Kagan, S., & Kagan, M. (2009). *Kagan cooperative learning*. San Clemente, CA: Kagan Publishing.
- C0-377 Canadian Yachting Association. (2002). *Level 2 technical coach manual*. Kingston, ON: Canadian Yachting Association.
- C0-381 McDonald, E. (2006). *How to involve and engage students*. Retrieved March 4, 2009, from http://www.education-world.com/a_curr/columnists/mcdonald/mcdonald007.shtml
- C0-383 Bell, A. (2007). *Creating a learning centered environment–Introduction*. Retrieved February 23, 2009, from <http://www.dialogueonlearning.tc3.edu/model/environment/Introduction-grp.htm>
- C0-385 Exalted Living. (2009). *Creativity on demand*. Retrieved March 3, 2009, from <http://www.exaltedliving.com/creativity.htm>
- C0-386 International Forum of Educational Technology & Society. (2006). *Integrating creativity into online university courses*. Retrieved February 11, 2009, from http://ifets.ieee.org/discussions/discuss_september2006.html
- C0-387 Beals, G. (1998). *Thomas Edison "Quotes"*. Retrieved March 9, 2009, from <http://www.thomasedison.com/index.html>
- C0-388 Schoenherr, N. (2007). *Being more creative in everyday life is simple, says author of 'Group Genius'*. Retrieved March 10, 2009, from <http://news-innfo.wustl.edu/tips/page/normal/9421.html>
- C0-389 Soria, R. (2009). *How to think like a genius*. Retrieved March 09, 2009, from <http://www.creativity-portal.com/howto/a/davinci/genius.html>
- C0-395 MindTools. (2009). *Approaches to creativity*. Retrieved March 16, 2009, from http://www.mindtools.com/pages/article/newCT_00.htm

MIXER

Proctor and Gamble very creatively combined Pringles potato chips and printing to produce Pringles Prints Potato Chips. Words and images are printed on one side of individual crisps in blue or red. (<http://www.junkfoodnews.net/PringlesPrints.htm>)

Combine the two elements to make a new phrase / word. The first one is done for you.

A TROLLEY AND A SUITCASE TO GET

luggage on wheels

AN IGLOO AND A HOTEL TO GET AN

A PHOTOCOPIER AND A TELEPHONE TO GET A

A BELL AND A CLOCK TO GET AN

A SURF BOARD AND A SAIL BOAT TO GET

FRENCH FRIES AND CHEESE TO GET

THIS PAGE INTENTIONALLY LEFT BLANK

PICTURE THIS...

Look at each picture and discuss how the pictures are creative.





**If you can think it,
you've just created it,
even if you can't
hold it in your hand."**

— Chris Dunmire

Figure B-1 Creative Pictures

Note. From *Creativity Portal: Nit Wits*, by C. Dunmire, 2007, Copyright (2007) by Chris Dunmire. Retrieved April 23, 2009, from <http://www.creativity-portal.com/becreative/activities>

Creativity / Writing Prompt:

List five ways the little gloved one can have its reflection, seeing all of his fingers upright. Tap into that imagination of yours and take it away!

CLICHE STRECTCHING

cliche *n* : a trite phrase or expression : trite *adj* : used so commonly that the novelty has worn off — *Merriam-Webster Dictionary*

This creativity exercise forces your brain to buzz. Skim through the list provided and identify the phrases that you find interesting. Then combine two or three cliches to form new coherent or funny phrases. Read the examples below for ideas.



a bad scene
add insult to injury
agree to disagree
all things considered
all too soon
along these lines
ample opportunity
armed to the teeth
as a matter of fact
at a loss for words
at one fell swoop
avoid it like the plague
awaiting further orders

back at the ranch
back to the drawing board
bated breath
beginning of the end
before you know it
benefit of the doubt
best-laid plans
better late than never
better left unsaid
beyond the shadow of a doubt
bite the bullet
bitter end
bone of contention
bottom line
budding genius

leave no stone unturned
leaves much to be desired
leave up in the air
lend a helping hand
let well enough alone
line of least resistance
little woman
lit up like a Christmas tree
live and let live
lock, stock, and barrel
long arm of the law
look before you leap

marked contrast
matter of life and death
mecca for travelers
method to his madness
milk of human kindness
miraculous escape
moment of truth
momentous occasion
monumental traffic jam
moot point
more than meets the eye
more the merrier
motley crew

narrow escape
nearest and dearest

burning question
busy as a bee
by leaps and bounds
by the same token

calm before the storm
call of the wild
casual encounter
chain reaction
charged with emotion
checkered past
cherished belief
circumstances beyond my control
clear as crystal
come full circle
contents noted
cool as a cucumber
curiously enough
cut a long story short
cut down in his prime

days are numbered
dead as a doornail
deafening crash
depths of despair
diamond in the rough
dig in your heels
do not hesitate to
drastic action
due consideration

each and every
easier said than done
eat, drink, and be merry
eminently successful
engage in conversation
epic struggle
even tenor
exception that proves the rule
existing conditions
express one's appreciation

fall on bad times
fall on deaf ears
far and wide
far be it from me
fateful day
fate worse than death
feel free to
feel vulnerable
festive occasion
few and far between

needs no introduction
never a dull moment
never before in the history of
nipped in the bud
no sooner said than done

one and the same
ongoing dialogue
on more than one occasion
open secret
order out of chaos
other things being equal
outer directed
overwhelming odds
own worst enemy

pales in comparison
paralyzed with fright
paramount importance
pay the piper
peer group
pet peeve
pick and choose
pie in the sky
pinpoint the cause
pipe dream
place in the sun
play hardball
play it by ear
poor but honest
powder keg
powers that be
pros and cons
proud heritage
proud possessor
pull one's weight

rack and ruin
ravishing beauty
red-letter day
regrettable incident
reigns supreme
reliable source
remedy the situation
right on
ripe old age
round of applause

sadder but wiser
saw the light of day
scathing sarcasm
sea of faces

final analysis
finishing touches
fit as a fiddle
food for thought
fools rush in
foregone conclusion
foul play
from the sublime to the ridiculous

generation gap
give the green light to
go down the drain
goes without saying
good team player
grave concern
green with envy
grim reaper
grind to a halt

hands across the sea
happy pair
hastily summoned
have the privilege
heartfelt thanks
heart of the matter
heart's desire
heated argument
heave a sigh of relief
herculean efforts
hook, line, and sinker
hook or crook
hope for the future
hot pursuit
hunker down

ignorance is bliss
ill-fated
immeasurably superior
in close proximity
infinite capacity
innocent bystander
in no uncertain terms
in our midst
in reference to
in short supply
in the limelight
in the nick of time
in the same boat with
in the twinkling of an eye
in this day and age
into full swing
irony of fate

seat of learning
second to none
select few
selling like hotcakes
shattering effect
shift into high gear
shot in the arm
sigh of relief
silence broken only by
silhouetted against the sky
simple life
skeleton in the closet
snug as a bug in the rug
social amenities
spectacular event
spirited debate
stick out like a sore thumb
stick to one's guns
straight and narrow path
structure one's day
such is life
superhuman effort
supreme sacrifice
sweat of his brow
sweeping changes
sweet sixteen

take the bull by the horns
telling effect
terror stricken
thanking you in advance
there's the rub
this day and age
those present
throw a monkey wrench
throw a party
throw caution to the wind
tie that binds
time of one's life
tongue in cheek
too funny for words
too numerous to mention
tough it out
tower of strength
trials and tribulations
trust implicitly

uncharted seas
unprecedented situation
untimely end
untiring efforts

irreplaceable loss
it dawned on me

keep options open

labor of love
lashed out at
last analysis
last but not least
last-ditch effort
leaps and bounds

vale of tears
vanish into thin air

watery grave
wax eloquent/poetic
weaker sex
wear and tear
whirlwind tour
wide open spaces
words fail to express
word to the wise
wrought havoc

Figure C-1 Brain Bender

Note. From *Creative Slush* by C. Dunmire, 2009, Copyright 2005–2009 by Chris Dunmire. Retrieved April 23, 2009, from <http://chrisdunmire.com/fun/mixedcliche.shtml>

MIXER ANSWER KEY

Proctor and Gamble very creatively combined Pringles potato chips and printing to produce Pringles Prints Potato Chips. Words and images are printed on one side of individual crisps in blue or red. (<http://www.junkfoodnews.net/PringlesPrints.htm>)

Combine the two elements to make a new word. The first one is done for you.

A TROLLEY AND A SUITCASE TO GET

luggage on wheels

AN IGLOO AND A HOTEL TO GET AN

ice hotel

A PHOTOCOPIER AND A TELEPHONE TO GET A

fax machine

A BELL AND A CLOCK TO GET AN

alarm clock

A SURF BOARD AND A SAIL BOAT TO GET

wind surfing

FRENCH FRIES AND CHEESE TO GET

poutine

THIS PAGE INTENTIONALLY LEFT BLANK

CELEBRATE SUCCESS

BRAIN KISS

1. Kiss the fingers on your open right hand.
2. Transfer the kiss to your brains by tapping your foreheads with the kissed hand.
3. Finish the kiss with flair by throwing the kissed hand in the air.

TRUCK DRIVER

1. Put your hands on the steering wheel of your pretend big rig.
2. Reach your left hand up and pull the cord of your air horns.
3. Let out two throaty honking roars, "honk, honk!"
4. Reach up with your right hand for your walkie talkie and speak into it, saying, "Chhhsshhh. Good job, good buddy. Chhhsshhh."

CHEESE GRATER

1. Hold an imaginary block of cheese in one hand and an imaginary grater in the other.
2. Slide the cheese against the graters five times and say, "Grate, grate, grate, grate, grate job!"

FIREWORKS

1. Push your palms together in front of your chests.
2. Raise your palms above your head, imitating a firework shooting into the sky, complete with a "whooooooosh" sound.
3. When the firework reaches its highest point of ascent, clap your hands above your head, snap your fingers, and wiggle your facedown fingers as you slowly lower your hands.

THIS PAGE INTENTIONALLY LEFT BLANK

THE BENEFITS OF CREATIVE LESSONS

Prevent Disruptions

Many times cadets misbehave during a lesson because of boredom. When they are bored, their minds begin to wander and they start to wonder " what would happen if I ... " The cadets' attention is not focused on the lesson and soon little disruptions occur which often become big disruptions. Creative lessons focus the cadets' attention on the instructional activity and they are too busy to become disruptive.

Engage Cadets

When the instructor develops a fresh approach to a lesson, the cadets become interested in the lesson and motivated to pay attention. If the instructor conducts activities that physically and mentally involves the cadets, a transfer of power from the instructor to the cadets occurs. The cadets assume more responsibility for their own learning and the instructor becomes a guide.

Involve More Cadets

In a traditional lesson, the instructor talks more than two thirds of the time, mostly giving instructions and answering questions. Less than one third of the time is spent on individual interactions with cadets in the form of praise, encouragement, specific feedback and guiding cadets as they work with others. In creative lessons the instructor communicates less to the whole group and more with individual cadets or small groups of cadets. By using techniques, such as those described at Attachment M, the instructor can involve at least half of the cadets in an interaction at one time and all of the cadets before the lesson is over.

Bridge the Gap Between Watching (Passive) and Doing (Active)

Learning is an active social process and occurs best when the cadets participate with their peers and their instructor to experiment with new ideas and complete exercises. Creative lessons encourage cadets to actively participate by providing them with interactive opportunities, rather than simply sit and watch or listen to the instructor.

Identify Cadets' Weaknesses

Continually involving cadets in interactive activities provides an observant instructor with numerous opportunities to identify who is doing well and who is experiencing difficulty. The instructor can then intervene and make changes to immediately meet that need rather than wait for the lesson or a series of lessons on the one topic to be concluded and tested.

Encourage the Cadets to Interact With One Another

Creative learning activities actively encourage social interactions between the cadets and their peers, and the cadets and their instructors. Learning is an active social process which cadets need to practice if they are to get the most out of the Cadet Program.

Pace Learning

To pace learning is to challenge the cadets just beyond their present level of ability. If challenged too far, cadets give up but if challenged too little, they become bored. The trick is to stimulate cadets to the point of mild discomfort, forcing them to learn something new.

THIS PAGE INTENTIONALLY LEFT BLANK

BENEFITS OF CREATIVE LESSONS WORKSHEET

Prevent Disruptions

Many times cadets _____ during a lesson because of boredom. Creative lessons _____ the cadets' _____ on the _____ and they are too busy to _____.

Engage Cadets

If the instructor conducts activities that physically and mentally involve the cadets they assume more _____ for their own learning and the instructor becomes a _____.

Involve More Cadets

In a _____ lesson, the instructor talks more than _____ of the time mostly giving _____ and _____. In _____ lessons the instructor communicates _____ to the whole _____ and more with individual _____ or _____ of cadets.

Bridge the Gap Between Watching (Passive) and Doing (Active)

Creative lessons encourage cadets to _____ by providing them with _____ rather than simply _____ and _____ or _____ to the instructor.

Identify Cadets' Weaknesses

Involving cadets in interactive activities provides an observant _____ with numerous opportunities to identify who is doing _____ and who is experiencing _____. The instructor can then _____ these cadets rather than wait for the lesson to be over.

Encourage the Cadets to Interact With One Another

Creative learning activities actively encourage _____ between the cadets and their _____ and the cadets and their _____.

Pace Learning

Creative lessons challenge the cadets just _____ their present level of ability. If challenged too far, cadets _____ but if challenged too little, they become _____.

THIS PAGE INTENTIONALLY LEFT BLANK

BENEFITS OF CREATIVE LESSONS ANSWER KEY

Prevent Disruptions

Many times cadets ***misbehave*** during a lesson because of boredom. Creative lessons ***focus*** the cadets' ***attention*** on the ***lesson*** and they are too busy to ***become disruptive***.

Engage Cadets

If the instructor conducts activities that physically and mentally involve the cadets they assume more ***responsibility*** for their own learning and the instructor becomes a ***guide***.

Involve More Cadets

In a ***traditional*** lesson, the instructor talks more than ***two thirds*** of the time mostly giving ***instructions*** and ***answering questions***. In ***creative*** lessons the instructor communicates ***less*** to the whole ***group*** and more with individual ***cadets*** or ***small groups*** of cadets.

Bridge the Gap Between Watching (Passive) and Doing (Active)

Creative lessons encourage cadets to ***actively participate*** by providing them with ***interactive opportunities*** rather than simply ***sit*** and ***watch*** or ***listen*** to the instructor.

Identify Cadets' Weaknesses

Involving cadets in interactive activities provides an observant ***instructor*** with numerous opportunities to identify who is doing ***well*** and who is experiencing ***difficulty***. The instructor can then ***help*** these cadets rather than wait for the lesson to be over.

Encourage the Cadets to Interact With One Another

Creative learning activities actively encourage ***social interactions*** between the cadets and their ***peers*** and the cadets and their ***instructor***.

Pace Learning

Creative lessons challenge the cadets just ***beyond*** their present level of ability. If challenged too far, cadets ***give up*** but if challenged too little, they become ***bored***.

THIS PAGE INTENTIONALLY LEFT BLANK

BENEFITS OF CREATIVE LESSONS PHRASE STRIPS

Cut-out each strip.

PREVENT DISRUPTIONS

MORE CADETS INVOLVED

MORE DOING THAN WATCHING

IDENTIFIES CADETS' WEAKNESSES

MORE CADET INTERACTIONS

PACE LEARNING

THE CREATIVE PROCESS

STAGE	DESCRIPTION	ACTION
Preparation	Look at the lesson content in as many different ways as possible. Brainstorm possible creative elements to include in the lesson. Decide generally where to include creative elements in the lesson.	Use visualizations such as diagrams, charts, and webs. Individually brainstorm at first. Group brainstorm with other creative people if necessary. Take time to reflect on the lesson and mentally picture what you would like to see happen during the lesson.
Incubation	Collect and sort all relevant information. Continue to analyze and imagine ways to deliver the lesson. Make connections between the two like or unusual items. Prepare for the accident or eureka moment when everything falls into place.	Become an expert on the subject of the lesson. Do the homework. Combine and recombine ideas, hunches and thoughts into different combinations no matter how much they are unlike or unusual. Use the forced analogy. Use reversal. Ask "How can the lesson be made boring?" This may kick start your creativity. Use provocation by making the statement: "Lessons should not be creative". Ask "What have I done?" rather than "Why have I failed?".
Illumination or Eureka	Everything falls into place often when the problem is not being thought of at all.	Relax. Creativity is found in the subconscious mind which is more accessible in a relaxed state.
Verification	Decide if the new idea, insight, hunch or thought works. Continue testing and improving the new idea, insight, hunch or thought.	Decide if the new idea improves the lesson or is merely a gimmick. Write the lesson. Never create something to be used forever.

THIS PAGE INTENTIONALLY LEFT BLANK

FORCED ANALOGY

FORCED ANALOGY—MATCHBOX

MATCHBOX	LOCAL SQUADRON
Striking surface on two sides	
Two Parts	
Sliding Centre	
Cardboard	
Decorated with print and colours	
Contains Matches	

FORCED ANALOGY—PENCIL

PENCIL	ASPECT OF THE CANADIAN CADET ORGANIZATION (CCO) SYMBOLIZED
Silver Ring	
Yellow Colour	
Six Sides	
Flat Sides	
Eraser	
Wood Shaft	
Lead	
Write	
Inexpensive	

FORCED ANALOGY

QUESTIONS:

1. What is the first stage of the creative process?
2. What is one technique which can be used in the incubation stage to make a connection between unlike elements?
3. What happens during the illumination or eureka stage?
4. What happens during the verification stage?

FORCED ANALOGY GUIDE

The following is a list of possible answers. Use these answers to help guide cadets if they are having difficulty with the activity.

FORCED ANALOGY—MATCHBOX

MATCHBOX	LOCAL SQUADRON
Striking surface on two sides	Flexibility
Two Parts	Officers and Cadets
Sliding Centre	More than one way to do things
Cardboard	Easily broken / can not be careless
Decorated with print and colours	Lots of fun activities
Contains Matches	Danger—always practice safety

FORCED ANALOGY—PENCIL

PENCIL	ASPECT OF THE CANADIAN CADET ORGANIZATION (CCO) SYMBOLIZED
Silver Ring	Cadets receive medals and awards
Yellow Color	At Cadet Summer Training Centres different trades are identified by different colors
Six Sides	Cadet leaders have to remember to do many things
Flat Sides	Some aspects of cadet life are traditional
Eraser	Some cadets / officers / aspects of cadet life should be changed
Wood Shaft	Customs and traditions
Lead	Cadets can be challenging—get the lead out
Write	Cadets write lessons, orders, logbooks, attendance rolls, etc.
Inexpensive	The CCO offers many opportunities at little cost

FORCED ANALOGY—PENCIL (alternate)

PENCIL	ASPECT OF THE CANADIAN CADET ORGANIZATION (CCO) SYMBOLIZED
Silver Ring	Highest Rank
Yellow Colour	Value excellence
Six Sides	Different types of training
Flat Sides	Things will not always run smoothly—pencil does not roll smoothly
Eraser	Colour represents the poppy
Wood Shaft	The Cadet Program is structured
Lead	In the centre of the pencil representing the aims of the CCO
Write	Good experience to put on a resume
Inexpensive	Can not always do things because of lack of money

QUESTIONS:

- Q1. What is the first stage of the creative process?
- Q2. What is one technique which can be used in the incubation stage to make a connection between unlike elements?
- Q3. What happens during the illumination or eureka stage?
- Q4. What happens during the verification stage?

ANTICIPATED ANSWERS:

- A1. The first stage is the preparation stage.
- A2. The forced analogy, reversal and provocation techniques can be used in the incubation stage.
- A3. An answer falls into place often unexpectedly.
- A4. In the verification stage the instructor must decide if the new idea improves the lesson or is merely a gimmick, write the lesson and continually update the lesson.

WAYS TO INCORPORATE CREATIVITY

INTRODUCTION—USE ATTENTION-GETTING DEVICES

In the introduction, the instructor should capture the cadets' interest and motivate them to learn by using attention-getting devices, such as:

- an interesting fact related to the lesson topic that shocks, surprises or arouses curiosity;
- an unusual statistic related to the lesson topic;
- a personal anecdote related to the topic;
- a rhetorical question—the instructor does not want or expect the cadets to answer;
- an overt-response question—the instructor does want or expect the cadets to answer;
- an interesting quotation by a famous person;
- a visual demonstration such as an object, picture or some other representation that relates to the topic; and
- an explanation of how the topic is relevant to the cadets' lives or in their best interest.

BODY—USE INFORMATION-PROCESSING TECHNIQUES

Rally robin. In pairs, cadets alternate generating oral responses.

Round robin. In teams, students take turns responding orally.

Pairs check. One partner solves a problem while the other coaches. Then they switch roles. After every two problems, pairs check their answers with another pair and celebrate.

Rally coach. Partners take turns, one solving a problem while the other coaches.

Timed pair share. In pairs, cadets share with a partner for a predetermined time while the partner listens. Then partners switch roles.

CONFIRMATION—ACTIVITIES

Jigsaw worksheets. Instead of having cadets complete a worksheet individually, break them into small groups and assign a portion of the worksheet to each group. Each group must complete its assigned portion of the worksheet and use a poster or some other presentation aid to present the information to the whole group.

Graphics. Have the cadets create graphic organizers such as webs or mobiles to summarize information.

Creative writing. Have the cadets create rhymes, poems or songs to summarize information. If teaching terminology, symbols or similar information, have the cadets write a fairy tale or children's story using the information.

Create a chart. Type chronological information using a large font and cut it up into strips. Organize the cadets into pairs or small groups and give each pair or group an envelope with the strips of information and have them work together to place the information in the correct order and paste it on a sheet of chart paper. Time the activity for fun.

Information chain. Have each cadet write one fact that they have learned during the class on a piece of coloured paper, if possible. Have the class line up in front of the room and invite the first cadet to read their slip then fold it into a link and staple it. Invite the next student to read a fact and attach it to the chain and continue in this fashion until all cadets have created a link.

Scavenger hunt. Teach identification lessons by planting clues around the room and having cadets engage in a scavenger hunt. The clues may be actual items or pictures of items. When cadets find an actual item or some representation of it, they must describe the item to the group.

Road trip. Create a road trip. Place stop signs around the room containing information describing what the cadet must do. The cadets travel to each place, complete the activity and have their passport stamped.

CONCLUSION

Read the closing statement directly from the lesson plan. Re-motivate the cadets by referring back to the introduction and stress how the material is relevant to their personal lives or in their best interest.

Finish in a dramatic manner with an attention-getting device such as that used to introduce the lesson.



**COMMON TRAINING
PROFICIENCY LEVEL FOUR
INSTRUCTIONAL GUIDE**



SECTION 10

EO C409.05 – ACT AS AN ASSISTANT DRILL INSTRUCTOR

Total Time:

90 min

PREPARATION

PRE-LESSON INSTRUCTIONS

Resources needed for the delivery of this lesson are listed in the lesson specification located in A-CR-CCP-804/PG-001, *Proficiency Level Four Qualification Standard and Plan*, Chapter 4. Specific uses for said resources are identified throughout the instructional guide within the TP for which they are required.

Review the lesson content and become familiar with the material prior to delivering the lesson.

PRE-LESSON ASSIGNMENT

The course officer shall communicate with the training officer to ensure that cadets are paired with a Proficiency Level One, Two or Three drill instructor during a regular training session. As part of the training session, the instructor and cadet should be scheduled for two periods of instruction. The time the cadet is not instructing may be used for lesson preparation, briefing, debriefing, securing training aids, etc.

A number of factors may exist based on the size of the squadron that will not allow for all Proficiency Level Four cadets to be scheduled for this EO at the same time. In this circumstance, special consideration should be given to minimize the cadet's absence from other areas of training. For example, scheduling half of the cadets for this EO while the other half is scheduled for EO C440.02 (Launch a Small Model Rocket) and reversing the schedule for the following training session.

APPROACH

OJT was chosen for this lesson as it allows the cadets to assist instructing a drill lesson in a safe and controlled environment. The OJT experience provides the cadets a practical application of learned skills in a realistic setting. The cadets reflect on the experience and receives feedback on the performance, which helps to shape future experiences. The cadets develop a sense of responsibility from the OJT aiding their development as a leader.

INTRODUCTION

REVIEW

Nil.

OBJECTIVES

By the end of this lesson the cadet shall have acted as an assistant drill instructor.

IMPORTANCE

It is important for cadets to act as an assistant drill instructor as it gives them the opportunity to practice, observe and assist in performing the duties of a drill instructor in a safe and controlled environment during a regular training session.

Teaching Point 1**Have the cadets act as assistant drill instructors in on-the-job training (OJT).**

Time: 90 min

Method: On-The-Job Training

PURPOSE

The purpose of having the cadets act as assistant drill instructors is to provide them with an authentic experience that allows them to observe and assist in performing the duties of a drill instructor during a regular training session. This activity is intended to be experiential in nature, providing the cadets the opportunity to work with experienced instructors, with assessment for learning being the focus rather than assessment of learning. When pairing the cadets with an instructor, consideration must be given to such things as the background, specialty and confidence of each cadet while in front of a class. The proper pairing of cadets with an instructor will help to ensure the OJT experience satisfies the stated purpose.

GENERAL INSTRUCTIONS

For one training session the cadets shall be paired with an instructor who is instructing a group of cadets participating in PO 108 (Participate in an Annual Ceremonial Review Parade), PO 208 (Execute Drill as a Member of a Squad) or PO 308 (Direct a Squad Prior to a Parade).

The instructor is responsible for the following:

1. Ensure the cadet is briefed on their responsibilities and tasks prior to the commencement of the lesson.
2. Ensure the cadet is provided opportunities to perform some or all tasks normally completed by the instructor, such as:
 - a. **Preparing training aids as required.** The cadet may be asked to gather and prepare training aids.



The focus of this EO should be the development of instructional skills and increasing experience and confidence while in front of a class. The instructor should develop training aids for the lesson. Give the cadet tasks such as setting up presentation aids and organizing training aids, eg, signing out rifles for a rifle drill lesson.

- b. **Helping instruct the lesson.** The cadet may be asked to provide a demonstration or instruct a TP of a lesson.
 - c. **Supervising the cadets.** The cadet may be asked to assist with the supervision of the cadets.
 - d. **Providing assistance as required.** The cadet may be asked to provide assistance or assist with skill development by coaching or demonstrating a skill being taught.
 - e. **Securing training aids as required.** Once the lesson is complete, the cadet may be asked to secure and return training aids to storage.
3. If necessary, debrief the (Proficiency Level One, Proficiency Level Two or Proficiency Level Three) cadets, correcting any content errors or omissions made by the cadet.
4. Debrief the cadet upon completion of the training session and provide them the opportunity to ask questions and seek additional feedback.

CONFIRMATION OF TEACHING POINT 1

The cadets' acting as an assistant drill instructor will serve as the confirmation of this TP.

END OF LESSON CONFIRMATION

The cadets' acting as an assistant drill instructor will serve as the confirmation of this lesson.

CONCLUSION

HOMEWORK / READING / PRACTICE

Nil.

METHOD OF EVALUATION

Nil.

CLOSING STATEMENT

Acting as an assistant drill instructor allows for the development of skills necessary to become a competent drill instructor by observing, practicing instruction and receiving feedback from an experienced drill instructor in a safe and controlled environment during a regular training session.

INSTRUCTOR NOTES / REMARKS

Prior to this EO, the course officer shall communicate with the training officer to ensure that cadets are paired with a Proficiency Level One, Two or Three drill instructor for a regular training session.

A number of factors may exist based on the size of the squadron that will not allow for all Proficiency Level Four cadets to be scheduled for this EO at the same time. In this circumstance, special consideration should be given to minimize the cadet's absence from other areas of training. For example, scheduling half of the cadets for this EO while the other half is scheduled for EO C440.02 (Launch a Small Model Rocket) and reversing the schedule for the following training session.

During this EO the instructor shall:

1. brief the cadet prior to commencing the lesson;
2. assign the cadet tasks, to include:
 - a. preparing training aids as required;
 - b. helping instruct the lesson;
 - c. supervising the cadets;
 - d. providing assistance as required; and
 - e. securing training aids as required;
3. monitor the cadet; and
4. debrief the cadet at the end of the lesson.

REFERENCES

Nil.

THIS PAGE INTENTIONALLY LEFT BLANK



**COMMON TRAINING
PROFICIENCY LEVEL FOUR
INSTRUCTIONAL GUIDE**



SECTION 11

EO C409.06 – INSTRUCT A 30-MINUTE DRILL LESSON

Total Time:	90 min
-------------	--------

PREPARATION

PRE-LESSON INSTRUCTIONS

Resources needed for the delivery of this lesson are listed in the lesson specification located in A-CR-CCP-804/PG-001, *Proficiency Level Four Qualification Standard and Plan*, Chapter 4. Specific uses for said resources are identified throughout the instructional guide within the TP for which they are required.

Review the lesson content and become familiar with the material prior to delivering the lesson.

The course officer shall communicate with the training officer to:

1. place the Proficiency Level Four cadets into the Proficiency Level One and Proficiency Level Two drill instructor schedules;
2. ensure the cadets are assigned a 30-minute lesson at least one week prior to conducting this assessment, to include:
 - a. a lesson specification, and
 - b. an instructional guide; and
3. assign an assessor to each lesson.

Ensure that all resources requested by the cadets are available.

Photocopy the Drill Instructional Techniques Assessment Form located at Attachment A for each cadet.

PRE-LESSON ASSIGNMENT

Nil.

APPROACH

A practical activity was chosen for this lesson as it is an interactive way for cadets to develop drill instructional skills in a safe and controlled environment.

INTRODUCTION

REVIEW

Nil.

OBJECTIVES

By the end of this lesson the cadet shall have instructed a 30-minute drill lesson using a written lesson plan and the drill instruction sequence.

IMPORTANCE

It is important for cadets to instruct a 30-minute drill lesson as it gives them the opportunity to practice drill instructional skills in a practical setting and to receive feedback to further develop instructional skills and confidence.

Teaching Point 1**Supervise while the cadets instruct a 30-minute lesson.**

Time: 85 min

Method: Practical Activity

ACTIVITY**OBJECTIVE**

The objective of this activity is to have the cadets instruct a 30-minute drill lesson using a written lesson plan and the drill instruction sequence.

RESOURCES

Drill Instructional Techniques Assessment Form.

ACTIVITY LAYOUT

Nil.

ACTIVITY INSTRUCTIONS

1. Have each cadet, prior to the start of this lesson:
 - a. research lesson content;
 - b. plan a lesson;
 - c. develop instructional aids (as required); and
 - d. set up the lesson location (as required).
2. During the time allotted for this lesson, have each cadet:
 - a. provide a copy of their written lesson plan to the assessor;
 - b. instruct a 30-minute drill lesson by:
 - (1) introducing the lesson;
 - (2) presenting the content of the lesson;
 - (3) applying the drill instruction sequence;
 - (4) confirming the skills learned during the lesson; and
 - (5) concluding the lesson; and
 - c. participate in an individual feedback session with the assessor upon completion of the lesson.



The Drill Instructional Techniques Assessment Form located at Attachment A is used to provide feedback on the cadet's lesson. The form is intended solely for the purposes of assessment for learning, providing the cadets with the feedback they need to improve their own skills.

3. Once all cadets have instructed a 30-minute drill lesson, debrief the (Proficiency Level Four) cadets by providing feedback, focusing on:
 - a. best practices,
 - b. general trends and key areas for improvement, and
 - c. re-motivation, highlighting the effort and accomplishments of the group.

SAFETY

Nil.

CONFIRMATION OF TEACHING POINT 1

The cadets' participation in the activity will serve as the confirmation of this TP.

END OF LESSON CONFIRMATION

The cadet's instructing a 30-minute drill lesson will serve as the confirmation of this lesson.

CONCLUSION

HOMEWORK / READING / PRACTICE

Nil.

METHOD OF EVALUATION

Nil.

CLOSING STATEMENT

Practicing drill instruction allows for the development of fundamental skills necessary to become a drill instructor while further developing confidence and providing a sense of accomplishment.

INSTRUCTOR NOTES / REMARKS

This EO shall be conducted after C309.04 (Identify Formations for Drill Instruction), EO C309.05 (Plan a Drill Lesson) and EO C309.06 (Instruct a 15-Minute Drill Lesson).

The cadets shall instruct Proficiency Level One or Proficiency Level Two cadets on a regular training session.

The course officer shall communicate with the training officer to:

1. place the Proficiency Level Four cadets into the instructor schedule; and
2. ensure the cadets are assigned a lesson at least one week prior to conducting this EO, to include:
 - a. a lesson specification, and
 - b. an instructional guide.

Time for lesson planning for this EO is available in EO C309.05 (Plan a Drill Lesson), should the course officer deem it necessary.

Adjust the period allocation for this EO if all three periods are not required for each Proficiency Level Four cadet to instruct a 30-minute drill lesson.

REFERENCES

A0-002 A-PD-201-000/PT-000 Director History and Heritage 3-2. (2005). *The Canadian Forces manual of drill and ceremonial*. Ottawa, ON: Department of National Defence.

THIS PAGE INTENTIONALLY LEFT BLANK

**DRILL INSTRUCTIONAL TECHNIQUES
 ASSESSMENT FORM**

Cadet's Name: _____

Division: _____

Lesson Topic: _____

CRITERIA	COMMENTS	Incomplete	Completed With Difficulty	Completed Without Difficulty
PREPARATION				
Maintained dress and deportment.				
Selected an appropriate squad formation.				
Used a lesson plan.				
Reviewed previous lesson.				
INTRODUCTION				
Stated what the cadets will learn.				
Stated why it is important.				
Stated where / when this skill will be applied.				
BODY				
Demonstrated complete movement, calling the time.				
Demonstrated and explained the first part of the movement (Squad 1).				
Had the squad practice the first part of the movement collectively, individually and collectively again.				
Taught the second part of the movement and each subsequent part in the same manner.				
Gave two complete demonstrations.				

CRITERIA	COMMENTS	Incomplete	Completed With Difficulty	Completed Without Difficulty
Practiced the complete movement with: <ul style="list-style-type: none"> • the instructor calling the time, • the cadets calling the time, and • the cadets judging the time. 				
Used clear words of command and correct pauses.				
Gave appropriate and immediate feedback.				
Allowed questions after each movement.				
END OF LESSON CONFIRMATION				
Demonstrated the movement taught.				
Confirmation was conducted as a squad.				
Emphasized aspects of the movement with which the cadets experienced difficulty.				
CONCLUSION				
Summarized the lesson.				
Re-motivated the cadets.				
FEEDBACK				

 ASSESSOR'S SIGNATURE

 DATE

 CADET'S SIGNATURE



**COMMON TRAINING
ALL TRAINING LEVELS
CANADIAN ARMED FORCES (CAF) FAMILIARIZATION
INSTRUCTIONAL GUIDE**



SECTION 1

PO X20 – PARTICIPATE IN CAF FAMILIARIZATION

Total Time:

For the following EOs, refer to the lesson specifications located in A-CR-CCP-801/PG-001, *Royal Canadian Air Cadets Proficiency Level One Qualification Standard and Plan*:

- MX20.01A – Participate in a CAF Activity,
- MX20.01B – Participate in a CAF Familiarization Tour,
- MX20.01E – Attend a CAF Presentation,
- MX20.01F – Attend a CAF Commemorative Ceremony, and
- CX20.01 – Participate in CAF Familiarization Activities.

For the following EOs, refer to the instructional guides located in A-CR-CCP-801/PF-001, *Royal Canadian Air Cadets Proficiency Level One Instructional Guides*:

- MX20.01C – Fire the C7 Rifle,
- MX20.01D – Participate in a Mess Dinner,
- MX20.01G – Participate in CAF Familiarization Video Activities, and
- MX20.01H – Participate in CAF Familiarization Learning Stations.

THIS PAGE INTENTIONALLY LEFT BLANK



**ROYAL CANADIAN AIR CADETS
PROFICIENCY LEVEL FOUR
INSTRUCTIONAL GUIDE**



SECTION 1

**EO C429.01 – EXPLAIN REGULATIONS AND OPERATING
PROCEDURES FOR AVIATION TRANSMISSION AND LICENSING**

Total Time:	30 min
-------------	--------

PREPARATION

PRE-LESSON INSTRUCTIONS

Resources needed for the delivery of this lesson are listed in the lesson specification located in A-CR-CCP-804/PG-001, *Proficiency Level Four Qualification Standard and Plan*, Chapter 4. Specific uses for said resources are identified throughout the instructional guide within the TP for which they are required.

Review the lesson content and become familiar with the material prior to delivering the lesson.

Photocopy the *Study Guide for the Restricted Operator Certificate With Aeronautical Qualification (ROC-A)* (RIC-21) available at <http://www.ic.gc.ca/eic/site/smt-gst.nsf/eng/sf01397.html>, for each cadet.

PRE-LESSON ASSIGNMENT

Nil.

APPROACH

An interactive lecture was chosen for this lesson to clarify, emphasize and summarize regulations and operating procedures for aviation transmission and licensing.

INTRODUCTION

REVIEW

Nil.

OBJECTIVES

By the end of this lesson the cadet shall have explained regulations and operating procedures for aviation transmission and licensing.

IMPORTANCE

It is important for cadets to explain regulations and operating procedures as the knowledge gives the cadets a better understanding of aviation transmission and licensing procedures. This knowledge is required to obtain the Industry Canada Restricted Operator Certificate with Aeronautical Qualification (ROC-A).



Distribute one copy of the *Study Guide for the Restricted Operator Certificate With Aeronautical Qualification (ROC-A) (RIC-21)* to each cadet. Have the cadets follow along with the study guide as content is presented.

Teaching Point 1

Explain priorities, privacy, and control of communication.

Time: 5 min

Method: Interactive Lecture

PRIORITIES

The priority of messages by flight service stations are:

- emergency communications, to include:
 - distress communication, and
 - urgency communications;
- flight safety communications, such as:
 - air traffic control (ATC) clearances,
 - airport advisories,
 - position reports, and
 - air file flight plans;
- scheduled broadcasts,
- unscheduled broadcasts,
 - notices to airmen (NOTAMS),
 - significant meteorological information (SIGMET), and
 - pilot weather report (PIREP); and
- other air-ground communications.

PRIVACY

No person shall reveal the contents, or the existence of communications transmitted, received, or intercepted by a radio station. Exceptions to this rule include revealing the contents to:

- the addressee of the message,
- authorized officials of the Government of Canada,
- officers of the court, and
- the operator of a telecommunication system necessary to forward or deliver the message.

The restrictions do not apply to the following messages:

- distress,
- urgency,
- safety, and
- ALL STATIONS addressed, such as:
 - weather reports, and
 - storm warnings.

CONTROL OF COMMUNICATION

An aircraft station will comply with instructions given by a ground station relating to:

- the order and time of transmission,
- the choice of frequency, and
- the duration and suspension of communications.



The ground station normally retains transmission control with communications between ground and aircraft stations.

The aircraft station called by another aircraft becomes the controlling station.

Radio communication between stations should be restricted to safety and flight regularity. Unauthorized communication, profane or obscene language, and calls that interfere with or interrupt the working of another radio station can result in a fine not exceeding \$5 000 and / or imprisonment for a term not exceeding one year. Anyone who knowingly sends, transmits, or causes any false or fraudulent distress signal, message, call, or radiogram of any kind may receive similar fines and / or imprisonment. A corporation can be fined up to \$25 000.

CONFIRMATION OF TEACHING POINT 1

QUESTIONS:

- Q1. What messages have highest priority?
- Q2. Which station retains transmission control between ground and aircraft stations?
- Q3. What is the maximum fine given to an individual for unauthorized communications or interference with another radio station?

ANTICIPATED ANSWERS:

- A1. Emergency communications.
- A2. Ground station.
- A3. \$5 000.

Teaching Point 2**Explain time, date, and transmission of numbers.**

Time: 5 min

Method: Interactive Lecture



Have the cadets follow along with the study guide as content is presented.

TIME

The 24-hour system is used to express time during radiocommunication. Time is expressed using four figures; the first two representing the hour past midnight and the last two representing the minutes past the hour.

Time is usually referenced to one standard time zone. If communication is conducted in a single time zone, local time is used.

Standard time zones are indicated as the following:

- Newfoundland N
- Atlantic A
- Eastern E
- Central C
- Mountain M
- Pacific P
- Yukon Y

Examples of time references include:

- 12:45 a.m. expressed as 0045,
- 7:40 a.m. expressed as 0740,
- 12:00 p.m. expressed as 1200,
- 1:35 p.m. expressed as 1335,
- 4:07 p.m. (EST) expressed as 1607 E,
- 7:40 p.m. expressed as 1940, and
- 9:50 p.m. (PST) expressed as 2150 P.

Coordinated Universal Time (UTC), also known as Zulu time (Z) or Greenwich Mean Time (GMT), is used to avoid confusion between different time zones. An example of UTC is 0539Z expressed as ZERO FIVE TREE NINER ZULU.



To convert local time to Zulu time add:

- 2.5 hours to Newfoundland Daylight Time (NDT),
- 3.5 hours to Newfoundland Standard Time (NST),
- 3 hours to Atlantic Daylight Time (ADT),
- 4 hours to Atlantic Standard Time (AST),
- 4 hours to Eastern Daylight Savings Time (EDT),
- 5 hours to Eastern Standard Time (EST),
- 5 hours to Central Daylight Savings Time (CDT),
- 6 hours to Central Standard Time (CST),
- 6 hours to Mountain Daylight Savings Time (MDT),
- 7 hours to Mountain Standard Time (MST),
- 7 hours to Pacific Daylight Savings Time (PDT), and
- 8 hours to Pacific Standard Time (PST) .

DATE

The date is expressed as a six-figure group. The first two figures represent the day of the month and the last four figures indicate the time.

TRANSMISSION OF NUMBERS

When referring to numbers, each digit is pronounced separately, except whole thousands. Whole thousands are communicated by pronouncing each digit in the number of thousands followed by the word thousand expressed as TOU-SAND. The word hundred is expressed as HUN-DRED. If a decimal is within the number, the word decimal is pronounced DAY-SEE-MAL. For example:

- 8 000 is expressed as AIT TOUSAND,
- 150 is expressed as WUN FIFE ZERO, and
- 75 is expressed as SEVEN FIFE.

Monetary denominations are transmitted with groups of digits including the decimal. Dollars is expressed if monetary denomination is higher than one dollar. For example, \$28.45 is expressed as DOLLARS TOO AIT DAY-SEE-MAL FOWER FIFE.

Altitude above sea level is expressed in thousands plus hundreds of feet. Separate digits are used to express flight level. For example:

- 2 800 is expressed as TOO TOUSAND AIT HUNDRED, and
- FL375 is expressed as FLIGHT LEVEL TREE SEVEN FIFE.

Aircraft type numbers are expressed in group forms. For example:

- Flight 498 is expressed as FLIGHT FOWER NINER AIT, and
- DC10 is expressed as DC TEN.

Wind speed and cloud formation heights are expressed in group forms. For example:

- Wind 270 / 10 is expressed as WIND TOO SEVEN ZERO DEGREES WUN ZERO KNOTS, and
- 36BKN is expressed as THIRTY SIX HUNDRED BROKEN.

Aircraft headings are given in groups of three digits. For example:

- 005 degrees is expressed as HEADING ZERO ZERO FIFE, and
- 350 degrees is expressed as HEADING TREE FIFE ZERO.

Aerodrome elevation is expressed in feet using the expression FIELD ELEVATION. For example:

- 178 is expressed as FIELD ELEVATION WUN SEVEN AIT, and
- 4900 is expressed as FIELD ELEVATION FOWER TOUSAND NINER ZERO ZERO.

CONFIRMATION OF TEACHING POINT 2

QUESTIONS:

- Q1. How is time expressed for the 24-hour system?
- Q2. How many figures will be used to express date and time together?
- Q3. How is aerodrome elevation expressed?

ANTICIPATED ANSWERS:

- A1. Four figures.
- A2. Six figures.
- A3. In feet using the expression FIELD ELEVATION.

Teaching Point 3

Explain operating procedures.

Time: 5 min

Method: Interactive Lecture



Have the cadets follow along with the study guide as content is presented.

OPERATING PROCEDURES

Words and Phrases

	<p>Slang expressions are not used during radiocommunication procedures including:</p> <ul style="list-style-type: none"> • ten-four, • over and out, • breaker-breaker, and • come in please.
---	---

Standard phrases and words are used whenever applicable including:

Acknowledge	Let me know that you have received and understood this message.
Affirmative	Yes or permission granted.
Break	Indicates the separation between portions of the message (to be used where there is no clear distinction between the text and other portions of the message).
Channel	Change to Channel ____ before proceeding.
Cleared	Authorized to proceed under the conditions specified.
Confirm	Have I received the following ____? or Did you receive the message?
Correction	An error has been made in this transmission (or message). The correct version is ____.
Disregard	Consider this transmission as not sent.
Do you read?	I have called you more than once. If you are receiving me, reply.
Go ahead	Proceed with your message.
How do you read me?	What is the readability of my transmission?
I say again	I will repeat.
Monitor	Listen on (frequency).
Negative	No or that is not correct or I do not agree.
Out	Conversation is ended and no response is expected.
Over	My transmission is ended and I expect a response from you.
Read back	Repeat all or the specified part of this message back to me exactly as received (do not use the word Repeat).
Roger	Okay, I have received all of your last transmission.
Say again	Repeat.
Stand by	I must pause for a few seconds or minutes, please wait and I will call you.
Seelonce	International expression to indicate that silence has been imposed on the frequency due to a distress situation.
Seelonce feenee	International expression to indicate that the distress situation has ended.
That is correct	Self-explanatory.
Verify	Check coding or text to confirm with originator.

Wilco	Your instructions received, understood, and will be complied with.
Words twice	As a request, communication is difficult, please send each word or group of words twice, or As information, since communication is difficult, I will send each word or group of words twice.

Call Signs

Call signs are assigned for identification purposes and should be used when contact is being established and again when communications are concluded. An aircraft's call sign can be the same as the aircraft's markings. Transport Canada (TC) assigns call signs and marks to aircraft.

	<p>Aircraft marks include C- (Canadian nationality mark) followed by the four-letter registration marks with aircraft letters starting with G or F and ultralight letters starting with I.</p> <p>Aircraft registered before January 1, 1974 are identified with the nationality mark CF.</p>
---	---

Aeronautical call signs are pronounced phonetically. During the initial contact, the manufacturer's name or type of aircraft is included, followed by the four letters of the registration. In further communications, the caller letters can be abbreviated to the last three letters.

- Cessna 172 GFLR is expressed as CESSNA WUN SEVEN TOO GOLF FOXTROT LIMA ROMEO then FOXTROT LIMA ROMEO, and
- Ultralight IKKO is expressed as ULTRALIGHT INDIA KILO KILO OSCAR then KILO KILO OSCAR.

Air carriers. Companies use their name followed by the flight number or the last three characters of the aircraft registration.

Civil registration. Private aircraft use the manufacturer's name or the type of the aircraft followed by the last four letters of the registration.

Ground stations. The name of the airport or its geographical location followed by a suitable word indicating the function of the station.

Examples:

- Area control centre: OTTAWA CENTRE,
- Flight information service station: WINNIPEG INFORMATION,
- Surface movement control: TORONTO GROUND,
- Private aeronautical station: RADIO, and
- Company dispatch: DISPATCH.

CONFIRMATION OF TEACHING POINT 3

QUESTIONS:

- Q1. Why are call signs assigned?
- Q2. Who assigns call signs?
- Q3. How are ground station call signs created?

ANTICIPATED ANSWERS:

- A1. Identification purpose.
- A2. TC.
- A3. Call signs are comprised of:
- name of the airport, or the airport geographical location, and
 - suitable word indicating the function of the station.

Teaching Point 4**Explain calling procedures.**

Time: 10 min

Method: Interactive Lecture



Have the cadets follow along with the study guide as content is presented.

CALLING PROCEDURES

A ground station that has a radio message for an aircraft within its operational service area may call the aircraft. When a ground station receives calls from several aircraft, the ground station will decide the order to take the calls.



If the radio conditions are good, the station's call sign is stated once but if conditions are poor, it is stated three times.

All stations shall listen to the communication channel before transmitting to ensure the transmission will not interfere with communication already in progress.

A station that has distress, urgency, or safety communications to transmit can interrupt a transmission of lower priority that is in progress.



The call sign of the station or aircraft being called is always spoken first followed by THIS IS and the calling station's or aircraft's call sign.

Single Station Call

A transmission is sent to a single station by stating:

- the call sign of the station being called,
- this is,
- the call sign of the station calling,
- the frequency on which the calling station is transmitting, and
- over (invitation to reply).

Example:

OTTAWA TOWER, (OTTAWA TOWER, OTTAWA TOWER),
THIS IS,
CESSNA WUN SEVEN TOO FOXTROT ALFA DELTA TANGO,
ON FREQUENCY WUN WUN AIT DAY-SEE-MAL SEVEN,
OVER.

All Station General Call

When a station needs to establish communication with any station within range or in a certain area, the call should be made to all stations.

Example:

ALL STATIONS, ALL STATIONS, ALL STATIONS,
THIS IS,
TORONTO RADIO (say three times if necessary),
BE ADVISED OF ___ IN THE AREA ___,
OUT.

Multiple Station Call

When more than one station is being called, the call signs of the desired stations may be transmitted in any sequence followed by THIS IS. The operators replying to multiple station calls should reply in the order in which they were called.

Example:

CESSNA WUN SEVEN TOO FOXTROT NOVEMBER INDIA LIMA,
PIPER FOXTROT X-RAY QUEBEC QUEBEC,
PIPER GOLF LIMA LIMA DELTA,
THIS IS,
TORONTO RADIO (say three times if necessary),
OVER.

Replying

Operators hearing a call directed to their station shall reply as soon as possible and advise the calling station to proceed, GO AHEAD or not to proceed with the message, STAND BY followed by the anticipated number of minutes of delay.

Example:

CESSNA WUN SEVEN TOO FOXTROT NOVEMBER INDIA LIMA,
THIS IS,
TORONTO TOWER,
GO AHEAD.

PIPER GOLF LIMA LIMA DELTA,
THIS IS,
TORONTO TOWER,
STAND BY TOO MINUTES.

Corrections and Repetitions

If an error is made during a transmission, the word correction is spoken followed by the correct word or phrase.

Example: PROCEED TO DOCK FIFE CORRECTION DOCK SEVEN.

If the receiving station requires an entire message to be repeated, the operator states SAY AGAIN. If only a portion of the message is required, the receiving station says the following:

- SAY AGAIN ALL BEFORE ____ (the first word satisfactorily received);
- SAY AGAIN ____ (the word before the missing portion) TO ____ (the word after the missing portion); and
- SAY AGAIN ALL AFTER ____ (the last word satisfactorily received).

Example:

VANCOUVER RADIO,
THIS IS,
STINSON FOXTROT ALFA BRAVO CHARLIE,
SAY AGAIN ALL BEFORE HANGAR,
OVER.

WINNIPEG TOWER,
THIS IS,
STINSON FOXTROT ALFA BRAVO CHARLIE,
SAY AGAIN ALTITUDE TO DESCEND,
OVER.

MONTREAL CENTRE,
THIS IS,
STINSON FOXTROT ALFA BRAVO CHARLIE,
SAY AGAIN ALL AFTER FLIGHT PLAN,
OVER.

Message Handling Procedures

When transmitting a message, the radio operator should:

1. Plan the message content before transmitting.
2. Listen briefly before starting to transmit the message to avoid interfering with other transmissions.
3. Deliver the radio message clearly and concisely using standard phrases.

The message format normally consists of the following four parts:

1. The call sign indicating the addressee and the originator.
2. The addressee reply.
3. The message.
4. The acknowledgement or ending.

The words THIS IS and OVER can be omitted on subsequent calls once the initial contact has been made with the addressee.

Example:

Call-up by aircraft	BROCKVILLE RADIO, THIS IS, PIPER FOXTROT ALFA BRAVO CHARLIE, OVER.
Reply by ground station	PIPER FOXTROT ALFA BRAVO CHARLIE, THIS IS, BROCKVILLE RADIO, GO AHEAD.
Message–Aircraft	BROCKVILLE RADIO, PIPER FOXTROT ALFA BRAVO CHARLIE, FOWER MILES AT WUN THOUSAND, LANDING BROCKVILLE.
Message–Ground	PIPER FOXTROT ALFA BRAVO CHARLIE, BROCKVILLE RADIO, ROGER, WIND WUN SIX ZERO DEGREES AT WUN FIFE KNOTS, ALTIMETER TOO NINER NINER SEVEN.
Acknowledgement–Aircraft	BROCKVILLE RADIO, PIPER FOXTROT ALFA BRAVO CHARLIE, ROGER, OUT.

Signal (or Radio) Checks

 Call using the appropriate frequency that will not interfere with the normal work of other aircraft or ground stations.

A signal (or radio) check is conducted by:

- calling another aircraft or ground station to request a signal check;
- stating signal (or radio) check 1, 2, 3, 4, 5. How do you read me? Over;
- including station call sign;
- transmitting the signal for less than 10 seconds; and
- replying or receiving a reply to a signal (or radio) check, use the following readability scale:
 - 1–bad (unreadable),
 - 2–poor (readable now and then),
 - 3–fair (readable but with difficulty),
 - 4–good (readable), and
 - 5–excellent (perfectly readable).

Communication checks are categorized as follows:

- signal check (made while aircraft is airborne),
- pre-flight check (made prior to departure), and
- maintenance check (made by ground maintenance).

Example:

Call-up by aircraft

WATSON LAKE RADIO,
THIS IS,
CESSNA FOXTROT ALFA BRAVO CHARLIE,
REQUEST SIGNAL CHECK ON FREQUENCY FIVE SIX DAY-
SEE-MAL AIT ZERO.

Response by station

CESSNA FOXTROT ALFA BRAVO CHARLIE,
THIS IS,
WATSON LAKE RADIO,
READING YOU STRENGTH FIVE,
OVER.

CONFIRMATION OF TEACHING POINT 4

QUESTIONS:

- Q1. When is the call sign not stated three times?
- Q2. When can a station interrupt with the call of another station?
- Q3. What does the radio operator do when transmitting a message?

ANTICIPATED ANSWERS:

- A1. When the radio conditions are good.
- A2. When it has a distress, urgency, or safety communication to transmit.
- A3. The radio operator will:
 - plan the message content;
 - listen briefly before starting to transmit the message to avoid interfering with other transmissions; and
 - deliver the radio message clearly and concisely using standard phrases.

END OF LESSON CONFIRMATION

QUESTIONS:

- Q1. List the priority of messages.
- Q2. How are date and time expressed?
- Q3. What phrase is used when a station needs to establish communication with any station within range or in a certain area?

ANTICIPATED ANSWERS:

- A1. Priority of messages include:
- emergency communications,
 - flight safety communications,
 - scheduled broadcasts,
 - unscheduled broadcasts, and
 - other air-ground communications.
- A2. Six figures:
- first two figures represent the day of the month,
 - next two figures represent the hour past midnight, and
 - last two figures represent the minutes past the hour.
- A3. ALL STATIONS.

CONCLUSION

HOMEWORK / READING / PRACTICE

Review the phonetic alphabet on page 6 in *Study Guide for the Radiotelephone Operator's Restricted Certificate (Aeronautical) (ROC-21)*.

METHOD OF EVALUATION

This EO is assessed IAW A-CR-CCP-804/PG-001 *Proficiency Level Four Qualification Standard and Plan*, Chapter 3, Annex B, 429 PC.

CLOSING STATEMENT

Being able to explain regulations and operating procedures gives the cadets a better understanding of aviation transmission and licensing procedures. This knowledge is required to obtain the Industry Canada Restricted Operator Certificate with Aeronautical Qualification (ROC-A).

INSTRUCTOR NOTES / REMARKS

If the squadron chooses to have cadets obtain the ROC-A, all complimentary EOs for this PO must be instructed and a qualified examiner must conduct 429 PC.

Cadets who are qualified Advanced Aviation may assist with this instruction.

REFERENCES

C3-116 ISBN 0-9680390-5-7 MacDonald, A. F., & Pepler, I. L. (2000). *From the ground up: Millennium edition*. Ottawa, ON: Aviation Publishers Co. Limited.

C3-182 *Study Guide for the Restricted Operator Certificate With Aeronautical Qualification (ROC-A) (RIC-21)*. (2008). Retrieved September 28, 2008, from www.ic.gc.ca/epic/site/smt-gst.nsf/en/sf01397e.html



ROYAL CANADIAN AIR CADETS
PROFICIENCY LEVEL FOUR
INSTRUCTIONAL GUIDE



SECTION 2

EO C429.02 – COMMUNICATE USING RADIO PROCEDURES FOR AVIATION TRANSMISSION

Total Time:

30 min

PREPARATION

PRE-LESSON INSTRUCTIONS

Resources needed for the delivery of this lesson are listed in the lesson specification located in A-CR-CCP-804/PG-001, *Proficiency Level Four Qualification Standard and Plan*, Chapter 4. Specific uses for said resources are identified throughout the instructional guide within the TP for which they are required.

Review the lesson content and become familiar with the material prior to delivering the lesson.

Prepare the handouts located at Attachments A and B for each cadet.

PRE-LESSON ASSIGNMENT

Read and practice the phonetic alphabet on page 6 in *Study Guide for the Radiotelephone Operator's Restricted Certificate (Aeronautical) (ROC-A)*.

APPROACH

An interactive lecture was chosen for TP 1–4 to clarify, emphasize and summarize radio procedures for aviation transmission.

An in-class activity was chosen for TP 5 as an interactive way to confirm the cadets' comprehension of radio procedures for aviation transmission.

INTRODUCTION

REVIEW

Nil.

OBJECTIVES

By the end of this lesson the cadet shall have communicated using common phrases, identified priority communications and emergency transmissions and conducted a radio check.

IMPORTANCE

It is important to know the correct radio phrases while communicating over a radio (for aviation transmissions). The cadet will use accurate terminology to communicate messages clearly and concisely.

Teaching Point 1**Explain the standard phrases used in a radio message.**

Time: 5 min

Method: Interactive Lecture



Distribute the handout showing procedural words and phrases located at Attachment A to each cadet.

The way that one talks on the air is guided by national and international standards. In aviation, common phrases and words are used to communicate radio messages. Citizen Band (CB) phrases, such as Ten-Four, Over and Out and Breaker Breaker will not be used.

Word or Phrase	Meaning
Acknowledge	Let me know that you have received and understood this message.
Affirmative	Yes, or permission granted.
Break	Indicates the separation between portions of the message. (To be used where there is no clear distinction between the text and other portions of the message.)
Confirm	My version is ... Is that correct?
Correction	An error has been made in this transmission (message indicated). The correct version is
Do you read	I have called you more than once. If you are receiving me, reply.
Go ahead	Self-explanatory.
How do you read?	Self-explanatory.
I say again	Self-explanatory (use instead of "I REPEAT").
Negative	No, or that is not correct, or I do not agree.
Out	Conversation is ended and no response is expected.
Over	My transmission is ended and I expect a response from you.
Read back	Repeat all of this message back to me exactly as received after I have given "OVER" (do not use the word "REPEAT").
Roger	I have received all of your last transmission.
Say again	Self-explanatory. (Do not use the word "REPEAT".)
Speak slower	Self-explanatory.
Stand by	I must pause for a few seconds or minutes, please wait.
That is correct	Self-explanatory.
Verify	Check coding, check text with originator and send correct version.
Wilco	Your instructions received, understood and will be complied with.

CONFIRMATION OF TEACHING POINT 1**QUESTIONS:**

- Q1. What terminology will not be used when communicating an aviation radio message?
- Q2. How do you say "Yes", or permission granted?
- Q3. How do you say that the transmission has ended and a response is expected?

ANTICIPATED ANSWERS:

- A1. CB phrases.
- A2. Affirmative.
- A3. Over.

Teaching Point 2**Explain priority of communication.**

Time: 5 min

Method: Interactive Lecture

PRIORITY OF COMMUNICATION

Radio transmissions are communicated in the following priority:

1. emergency communications, to include:
 - a. distress,
 - b. urgency,
 - c. safety; and
2. flight safety communications, to include
 - a. Air Traffic Control (ATC) clearance (authorization from ATC for an aircraft to land, take-off, etc),
 - b. airport advisories (landing and takeoff information about wind direction and velocity, favoured runway, airport conditions such as snow, known hazards, etc),
 - c. position reports (identification of surrounding aircraft, present position, altitude, type of flight plan and destination), and
 - d. air filed flight plans, etc;
3. scheduled broadcasts (Automated Terminal Information Service (ATIS), recorded information for arriving and departing aircraft such as airport name, weather information, departure runways, etc);
4. unscheduled broadcasts, to include:
 - a. Notices to Airmen (NOTAMS) (dangerous or restricted areas, airport construction, changes in navigation and control procedures),
 - b. Significant Meteorological Information (SIGMET) (messages to aircraft in flight of severe and hazardous weather conditions which include severe turbulences, thunderstorms, etc), or
 - c. Pilot Weather Report (PIREP) (unpredicted thunderstorms, turbulences, visibility, etc); and
5. other air-ground or air-to-air communications (conversations about personal information such as estimated time of arrival (ETA) for personal reasons, meals, etc).

CONFIRMATION OF TEACHING POINT 2

QUESTIONS:

- Q1. What type of communication has highest priority?
- Q2. ATC clearance is where on the communication priority position?
- Q3. Unscheduled broadcasts include what types of communication?

ANTICIPATED ANSWERS:

- A1. Emergency communications (distress, urgency and safety calls).
- A2. Second.
- A3. Notices to Airmen (NOTAMS), Significant Meteorological Information (SIGMET) or a Pilot Weather Report (PIREP).

Teaching Point 3

Explain emergency transmissions.

Time: 5 min

Method: Interactive Lecture

EMERGENCY TRANSMISSIONS

Emergency transmissions have first priority in communications and are transmitted using specific terms which are repeated three times.

Distress

Distress calls have absolute priority over all other transmissions. Anyone hearing it will cease any transmission capable of interfering. Distress calls indicate that the aircraft is threatened by grave and / or imminent danger, such as an engine loss and require immediate assistance.

The transmission for distress is "MAYDAY" "MAYDAY" "MAYDAY".

Urgency

Urgency calls are addressed to all stations or a specific station. Urgency calls concern the safety of the aircraft, someone on board or within sight, such as a lost position but does not require immediate assistance.

The transmission for urgency is "PAN PAN" "PAN PAN" "PAN PAN".

Safety

Safety messages address the safety of navigation or important meteorological warning to aircraft in flight such as severe turbulences.

The transmission for safety is "SECURITY" "SECURITY" "SECURITY".

CONFIRMATION OF TEACHING POINT 3**QUESTIONS:**

- Q1. What word do you use to start your radio transmission when your engine stops?
- Q2. What word do you use to start your radio transmission when you have lost your position?
- Q3. What word do you use to start your radio transmission when you want to report an important meteorological warning to other aircraft in flight?

ANTICIPATED ANSWERS:

- A1. "MAYDAY".
- A2. "PAN PAN".
- A3. "SECURITY".

Teaching Point 4**Explain a radio check.**

Time: 5 min

Method: Interactive Lecture

RADIO CHECK

Radio checks are used to assess the serviceability of the communication equipment. Radio checks use a 1–5 scale to assess the readability and strength of the transmission.

Readability

Readability assesses the ability to understand the communication. Readability is confirmed using the scale of 1–5 to relate to levels of understanding to include:

- 1–unreadable,
- 2–readable now and then,
- 3–readable with difficulty,
- 4–readable, and
- 5–perfectly readable.

Strength

Strength assesses how strong the radio signal is being received. Strength is confirmed using the 1–5 scale which relates to levels of radio strength to include:

- 1–bad,
- 2–poor,
- 3–fair,
- 4–good, and
- 5–excellent.

When a radio check is requested, the response uses the numerical scale for readability then strength, such as 4 / 3 (readable / fair strength) or 3 / 5 (readable with difficulty / excellent strength). If both readability and strength are at the maximum scale, the response is five.

Radio checks may be conducted as part of the pre-flight check, ground maintenance check and while airborne to check the serviceability of communication equipment. Radio checks should not be conducted on an active ATC frequency.

CONFIRMATION OF TEACHING POINT 4

QUESTIONS:

- Q1. Why is a radio check conducted?
- Q2. A radio transmission is readable with difficulty and has good strength. What is the response?
- Q3. Radio checks are done in three categories. Name each.

ANTICIPATED ANSWERS:

- A1. To assess the serviceability of the communication equipment.
- A2. Three by four.
- A3. Signal check (when airborne), pre-flight check (prior to departure) and maintenance check (made by ground maintenance).

Teaching Point 5

Have the cadets, in pairs, conduct station-to-station calls using the ITU phonetic alphabet and numbers, and conduct a signal check.

Time: 5 min

Method: In-Class Activity

ACTIVITY



Radios should be set to different frequencies. The cadets have previously learned this procedure during EO M290.06 (Operate a Hand-Held Radio).

The number of radios available per squadron varies. If necessary, one pair of cadets will complete the activity and a second pair of cadets will critique their technique. Groups will switch roles and repeat the activity.

OBJECTIVE

The objective of this activity is for the cadets to send and receive messages using the ITU phonetic alphabet and numbers.

RESOURCES

- Hand-held radio (one per group), and
- Radio Activity located at Attachment B.

ACTIVITY LAYOUT

Nil.

ACTIVITY INSTRUCTIONS

1. Divide the cadets into pairs.
2. Provide each pair of cadets with a hand-held radio and a copy of the radio activity.
3. Have the cadets complete the radio worksheet.
4. Have one cadet transmit the message to their partner by:
 - a. turning the radio on;
 - b. using message parts, to include:
 - (1) initiating a call with "____" this is "____", over;
 - (2) answering a call with "____" this is "____", go ahead, over";
 - (3) requesting a signal check on a different frequency;
 - (4) responding to the request; and
 - (5) acknowledging the call and ending the call with "out";
 - c. using radio techniques; and
 - d. turning the radio off.
5. Have the cadets switch roles and repeat Step 4.

SAFETY

Nil.

CONFIRMATION OF TEACHING POINT 5

The cadets' participation in the activity will serve as the confirmation of this TP.

END OF LESSON CONFIRMATION**QUESTIONS:**

- Q1. How do you say that the transmission has ended and you expect a response?
- Q2. Air-ground and air-to-air communication of a personal nature is where on the communication priority?
- Q3. What three words are used and in what order, to announce emergency transmissions?
- Q4. During a radio check, both readability and strength are at the maximum, what is the response?

ANTICIPATED ANSWERS:

- A1. Over.
- A2. Last.

A3. MAYDAY, PAN PAN, AND SECURITY.

A4. Five.

CONCLUSION

HOMEWORK / READING / PRACTICE

Nil.

METHOD OF EVALUATION

This EO is assessed IAW A-CR-CCP-804/PG-001 *Proficiency Level Four Qualification Standard and Plan*, Chapter 3, Annex B, 429 PC.

CLOSING STATEMENT

The cadets are better prepared to communicate using the standard radio phrases, priority of communications, emergency phrases and are able to conduct a radio check. The knowledge learned will ensure the cadets utilize the correct terminology and radio messages will be clear and concise.

INSTRUCTOR NOTES / REMARKS

If the squadron chooses to have cadets obtain the ROC-A, all complementary EOs for this PO must be instructed, and a qualified examiner must conduct 429 PC.

Cadets who are qualified Advanced Aviation may assist with this instruction.

REFERENCES

C3-116 ISBN 0-9680390-5-7 MacDonald, A.F., & Pepler, I.L. (2000). *From the ground up: Millennium edition*. Ottawa, ON: Aviation Publishers Co. Limited.

C3-182 *Study Guide for the Radiotelephone Operator's Restricted Certificate (Aeronautical)*. (1990). Retrieved October 23, 2007, from www.ic.gc.ca/epic/site/smt-gst.nsf/en/sf01397e.htm

Procedural Words and Phrases

Word or Phrase	Meaning
Acknowledge	Let me know that you have received and understood this message.
Affirmative	Yes, or permission granted.
Break	Indicates the separation between portions of the message. (To be used where there is no clear distinction between the text and other portions of the message.)
Confirm	My version is ... Is that correct?
Correction	An error has been made in this transmission (message indicated). The correct version is
Do you read?	I have called you more than once. If you are receiving me, reply.
Go ahead	Self-explanatory.
How do you read?	Self-explanatory.
I say again	Self-explanatory (use instead of "I REPEAT").
Negative	No, or that is not correct, or I do not agree.
Out	Conversation is ended and no response is expected.
Over	My transmission is ended and I expect a response from you.
Read back	Repeat all of this message back to me exactly as received after I have given "OVER" (do not use the word "REPEAT").
Roger	I have received all of your last transmission.
Say again	Self-explanatory. (Do not use the word "REPEAT".)
Speak slower	Self-explanatory.
Stand by	I must pause for a few seconds or minutes, please wait.
That is correct	Self-explanatory.
Verify	Check coding, check text with originator and send correct version.
Wilco	Your instructions received, understood and will be complied with.

THIS PAGE INTENTIONALLY LEFT BLANK

Radio Activity

Send and receive the following message using the ITU phonetic alphabet and numbers.

Make a call sign for this exercise representing an aircraft, including:

- first name and age,
- C–G, and
- three letters.

Example call sign: DOUG 16 C–GABR (DOUG WUN SIX CHARLIE–GOLF ALPHA BRAVO ROMEO).

Make a call sign for this exercise representing the ground station, including:

- home community, and
- radio.

Example call sign: BROCKVILLE RADIO.

Radio Worksheet

Fill in the following sheet to assist with transmitting the message.

Cadet A (initial and age): _____

Aircraft: C–G _____

Cadet B (initial and age): _____

Aircraft: C–G _____

Call Sign (local community): _____ RADIO

After the initial call-up, stations do not have to repeat the words THIS IS and OVER.

Sending a Message

Call-up by aircraft:

_____ THIS IS _____ OVER.
Cadet B call sign Cadet A call sign

Reply by ground station:

_____ THIS IS _____ GO AHEAD, OVER.
Cadet A call sign Cadet B station

Message - aircraft:

_____ , _____ SIGNAL CHECK ON 5680.
Cadet B station Cadet A call sign

Message - ground station:

_____ , _____ READING YOU _____
Cadet A call sign Cadet B station (fill in response)

Acknowledgement - aircraft:

_____ , _____ ROGER, OUT.
Cadet B station Cadet A call sign



ROYAL CANADIAN AIR CADETS
PROFICIENCY LEVEL FOUR
INSTRUCTIONAL GUIDE



SECTION 3

EO C429.03 – DESCRIBE RADIO WAVELENGTHS, SIGNALS, LICENCES AND EQUIPMENT

Total Time:

30 min

PREPARATION

PRE-LESSON INSTRUCTIONS

Resources needed for the delivery of this lesson are listed in the lesson specification located in A-CR-CCP-804/PG-001, *Proficiency Level Four Qualification Standard and Plan*, Chapter 4. Specific uses for said resources are identified throughout the instructional guide within the TP for which they are required.

Review the lesson content and become familiar with the material prior to delivering the lesson.

Photocopy the handouts located at Attachments A and C for each cadet.

Prepare slides located at Attachments B and D.

PRE-LESSON ASSIGNMENT

Nil.

APPROACH

An interactive lecture was chosen for this lesson to orient the cadets to the topic of radio wavelengths, signals, licences, and equipment and to create interest in the subject.

INTRODUCTION

REVIEW

Nil.

OBJECTIVES

By the end of this lesson the cadet shall describe radio wavelengths, signals, licences and equipment.

IMPORTANCE

It is important for cadets to describe radio wavelengths, signals, licences and equipment as it helps them to better understand radio theory and licencing procedures. This information is required knowledge for the Industry Canada Restricted Operator Certificate with Aeronautical Qualification (ROC-A).

Teaching Point 1**Describe radio wavelengths, frequencies and bands.**

Time: 5 min

Method: Interactive Lecture



Distribute the handout located at Attachment A to each cadet. Cadets will label the handout as the information is presented.

CYCLE

Show the slide of Figure B-1 to the cadets.

When a pebble is dropped into water, waves are made. The waves decrease in height or strength as they travel away from the point of origin. The lengths of the waves never vary.

A radio transmitter sends out waves known as wavelengths. The linear measurement of the wave is measured in metres (m). A wavelength is the distance between two successive crests or two successive troughs.

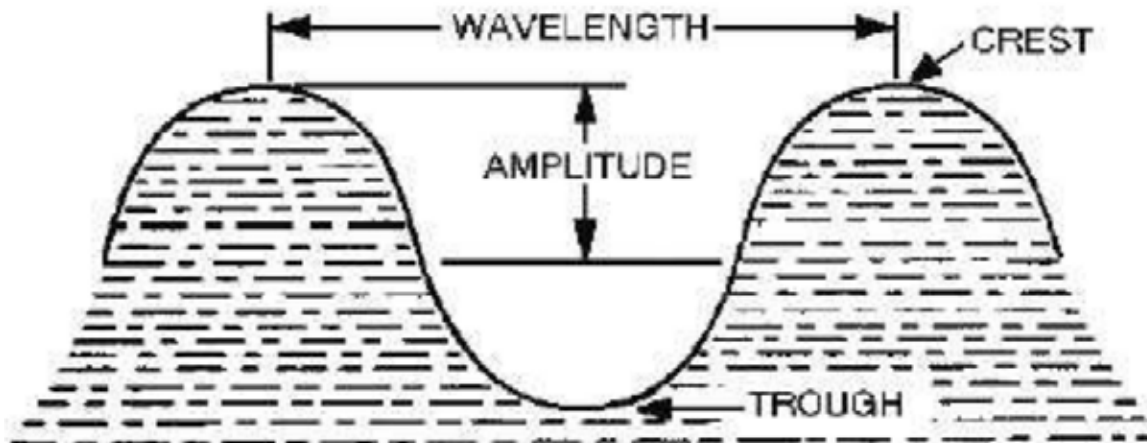

Figure 1 Wavelength

Note. From Integrated Publishing, *Transverse Wave*. Retrieved October 31, 2008, from http://www.tpub.com/content/neets/14182/css/14182_17.htm



Show the slide of Figure B-2 to the cadets.

Every crest (highest part of the wave) is separated by a trough (lowest part of the wave) to create an alternating pattern of crests and troughs known as cycles. A cycle is the period of time in which the wave vibrates up and down.

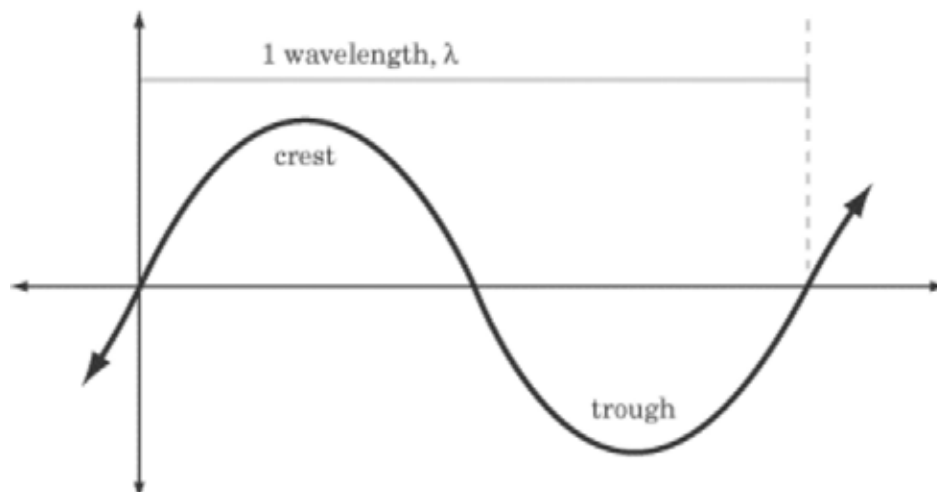

Figure 2 Crest and Trough

Note. From "SparkNotes", 2006, *Crests, Troughs, and Wavelength*. Retrieved October 24, 2008, from <http://sparknotes.com/testprep/books/sat2/physics/chapter17section2.rhtml>

The number of cycles per second is called frequency. The unit for frequency is the Hertz (Hz) where one Hz is equivalent to one cycle per second.



Show the slide of Figure B-3 to the cadets.

The lowest frequencies have the longest radio waves and the highest frequencies have the shortest radio waves.

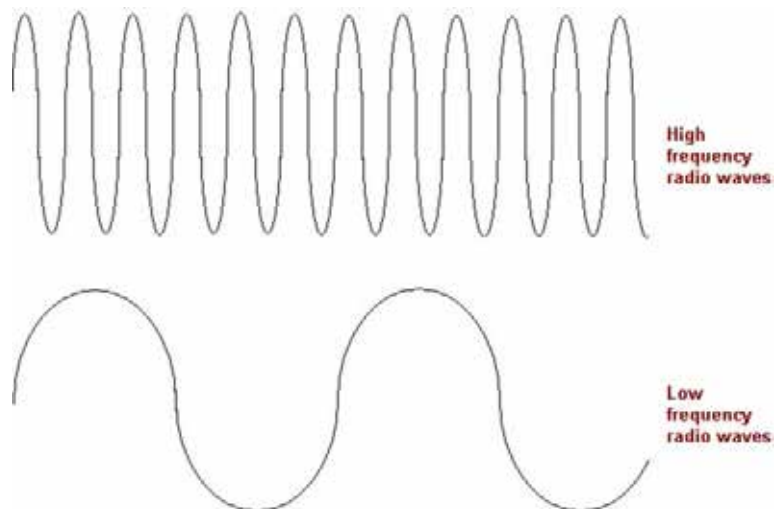

Figure 3 Radio Wave Frequencies

Note. From "Communications System", *What is Frequency?* Retrieved October 24, 2008, from <http://qrg.northwestern.edu/project/vss/docs/Communications/1-what-is-frequency.html>

KILOHERTZ

Very low to high frequencies are measured in kilohertz (kHz). kHz represents 1 000 waves passing a fixed point in one second.

MEGAHERTZ

Very high frequencies are measured in megahertz (MHz). MHz represents 1 000 kHz or 1 000 000 Hz passing a fixed point in one second.



The relationship between Hz, kHz and MHz can be explained as 1 000 000 Hz = 1 000 kHz
= 1 MHz

LOW, MEDIUM, VERY HIGH, AND ULTRA HIGH FREQUENCY BANDS

Radio waves use the electromagnetic spectrum. The spectrum is divided into a number of frequency bands each possessing characteristics that determine the usage. Industry Canada, on behalf of the World Radio Communication Conference (WRC), allocates specific frequency bands to service domestic communication requirements.

Aviation radio communication facilities and radio navigation aids operate in different bands including:

- low frequency (LF),
- medium frequency (MF),
- high frequency (HF),
- very high frequency (VHF), and
- ultra high frequency (UHF).

Low Frequency (LF) Band

Non-directional and marker beacons transmit navigational signals as well as some voice transmissions in the 200–415 and 510–535 kHz band.

Medium Frequency (MF) Band

Commercial broadcasts can be used for directional bearings with automatic direction finding equipment in the 550–1 750 kHz band.

High Frequency (HF) Band

High frequencies are allocated in 100 kHz increments between 2 500–30 000 kHz. Numerous HF frequencies have been given to aviation. HF is excellent for air / ground communication. HF radio is the only way to maintain constant contact at ranges of 4 023 kilometres or more on transoceanic flights.

HF signals can be unpredictable, being affected by the day and night variations of the ionosphere as well as sunspots, auroras, etc.

HF stations in the upper range of HF bands get greater reception distance during daylight hours. Stations in the lower range get greater reception distance during the night.



Remember the mnemonic:

- sun up, frequency up, and
- sun down, frequency down.

Very High Frequency (VHF) Band

The most important band is between 30–300 MHz known as the VHF band. Certain ranges for frequencies have been allocated exclusively for aviation including:

- 108.00–117.98 MHz for navigational stations,
 - VHF omnidirectional range (VOR) stations,
 - instrument landing systems (ILS), and
 - voice reception;
- 118.00–136.00 MHz is allocated for civilian aviation voice communication, and
- 136.00–136.975 MHz is allocated for civilian aviation used mostly for air carriers for en route communication.

The most common VHF frequencies include:

- 121.50 MHz—universal VHF emergency,
- 122.20 MHz—flight service stations in Canada for both transmitting and receiving,
- 122.350–122.700 MHz—private advisory stations transmit and receive,
- 122.800 MHz—universal communications (UNICOM) facility is an air-to-ground communication facility operated by a private agency to provide private advisory station (PAS) service at uncontrolled airports,
- 122.90 MHz—used by aircraft engaged in various private aeronautical activities, such as:
 - parachute jumping,
 - aerial crop spraying, and
 - formation flying;
- 123.400 MHz—used for soaring activities, and
- 126.70 MHz—for transmitting position reports and general communication with a flight service station in uncontrolled airspace.

Ultra High Frequency (UHF) Band

Except for the glide slope portion of the instrument landing system (ILS) and distance measuring equipment (DME), the frequencies lying between 300–3 000 MHz are allocated for government use.

FREQUENCY ALLOCATION



With the numerous VHF channels in use and with changes occurring continuously, it is advisable to state the frequency on which the call is being made to any airway communication station, control tower or other facility.

VHF channels have been allotted for various aeronautical facilities under the Frequency Utilization Plan. Changes to the plan are made from time to time and published in Transport Canada (TC) Information Circulars.

CONFIRMATION OF TEACHING POINT 1

QUESTIONS:

- Q1. What is a cycle?
- Q2. What does one Hz equal?
- Q3. Airway radio communication facilities and radio navigation aids operate in what bands?

ANTICIPATED ANSWERS:

- A1. A cycle is the period of time in which the wave vibrates up and down.
- A2. One Hz equals one cycle per second.
- A3. Airway radio communication facilities and radio navigation aids operate in different bands including:
- low frequency (LF),
 - medium frequency (MF),
 - high frequency (HF),
 - very high frequency (VHF), and
 - ultra high frequency (UHF).

Teaching Point 2

Describe characteristics of radio signals.

Time: 5 min

Method: Interactive Lecture

Radio waves travel both along the Earth and into the atmosphere. Each has characteristics that assist the transmission of the radio signal. Ground waves (surface waves) travel along the contour of the Earth by diffraction. Sky waves (spaces waves) can travel through the air directly to the receiving antenna or can be reflected from the ionosphere.



Distribute the handout located at Attachment C to each cadet. Cadets will label the handout as the information is presented.

Ground Waves



Show the slide of Figure D-1 to the cadets.

Ground waves travel by following the contours of the Earth. Travelling in straight lines, the wave will bend or curve, known as diffraction, around objects. As part of the ground wave comes in contact with the surface, it

loses some of its energy, weakening or attenuating the ground wave. This loss of energy causes a downward tilt which helps the wave follow the Earth's curvature.

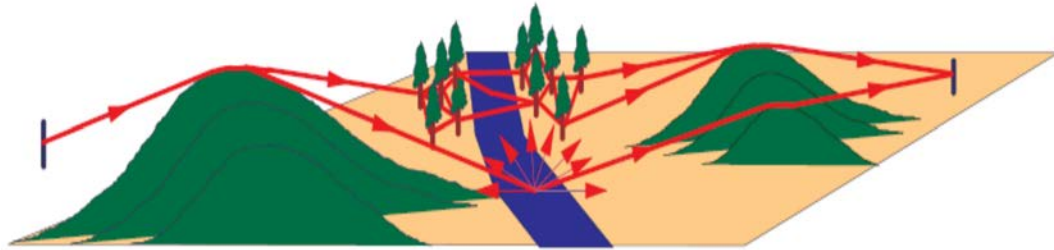

Figure 4 Ground Wave Transmission

Note. From *Radio Wave Diffraction and Scattering Models for Wireless Channel Simulation* (p. 5), by M. Casciato, 2001, Michigan: USA. Copyright 2001 by M. Casciato. Retrieved October 31, 2008, from <http://www.eecs.umich.edu/RADLAB/html/NEWDISS/Casciato.pdf>

Attenuation of the wave is affected by the nature of the surface. A radio wave will travel further over water, especially salty water, than land. Sand and ice cause poor conductivity compared to rich agricultural or marshy soil. Ground waves work best at lower frequencies.

Sky Waves



Show the slide of Figure D-2 to the cadets.

Transmission beyond the line of sight is possible through sky waves. Sky waves are radio waves that propagate into the atmosphere and bend back to the Earth from the ionosphere at some distance from the transmitter. Long-range communication is the result of sky wave transmission.

Two factors determine sky wave propagation: radio frequency and the level of ionization. Transmission of low, medium and high frequency radio waves vary by night and day. Sky waves travel at a flatter angle during the night. Sunspot activity or electromagnetic disturbances usually means more ionization of the ionosphere. HF communication is enhanced during times of greater sunspot activity.

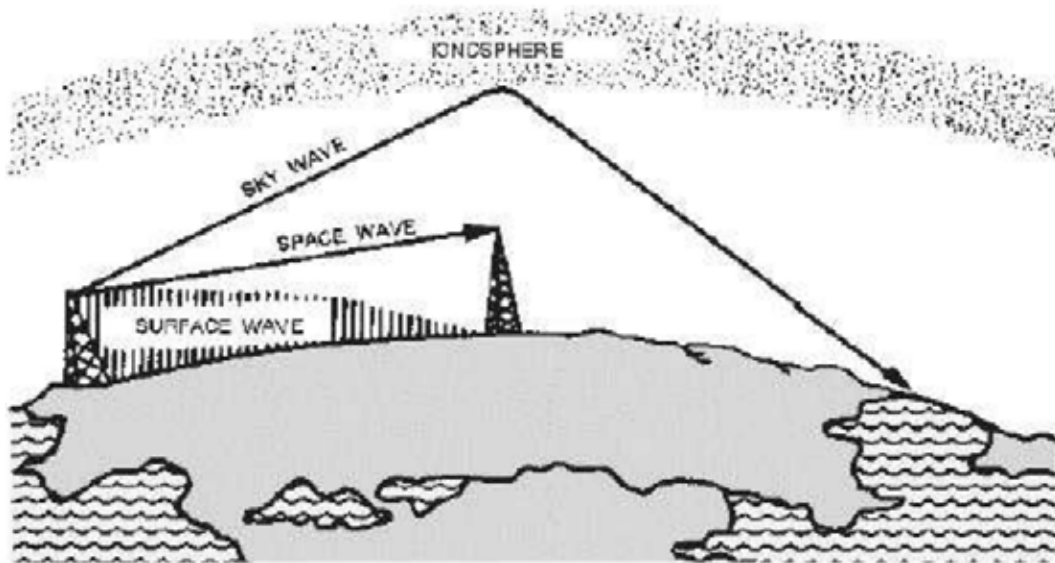

Figure 5 Sky Wave Transmission

Note. From "Integrated Publishing", *Radio Wave Transmission*. Retrieved October 31, 2008, from http://www.tpub.com/content/neets/14182/css/14182_75.htm

CONFIRMATION OF TEACHING POINT 2

QUESTIONS:

- Q1. What do ground waves follow?
- Q2. What is attenuation?
- Q3. From where does a sky wave reflect back to the Earth?

ANTICIPATED ANSWERS:

- A1. The curvature of the Earth.
- A2. The loss of energy when part of the ground wave comes in contact with the surface.
- A3. The ionosphere.

Teaching Point 3

Describe aeronautical terms and definitions.

Time: 5 min

Method: Interactive Lecture

AERONAUTICAL TERMS AND DEFINITIONS

Aerodrome. Defined as any area, land or water, including any building, installations, and equipment used for the arrival or departure, movement, and servicing of aircraft.

Aeronautical service. A radio communication service that provides for the safety, navigation, and other operations of an aircraft including the exchange of air-to-ground messages.

Aircraft station. A mobile station in the aeronautical service other than a survival craft, located on board an aircraft.

Aeronautical Operation Control Communications (AOCC). Communications related to the regularity of flight.

Aeronautical station. Location on land, on board a ship, or on a platform at sea receiving an aeronautical service. An aeronautical station may be as simple as a hand-held radio.

Air Traffic Control (ATC) Service. A service provided for the purpose of:

- preventing collisions between:
 - aircraft,
 - aircraft and obstructions, and
 - aircraft and vehicles on the manoeuvring area; and
- expediting and maintaining an orderly flow of air traffic.

Controlled aerodrome. An aerodrome at which an ATC service is provided.

Flight Service Station (FSS). A service providing mobile and fixed communications, airport advisory service (AAS), flight information, search and rescue alerting and weather and flight planning services to pilots and other users.

General Aviation Communication (GAC). Communication relating to all civil aviation operations other than for scheduled air service and non-scheduled air transport operations for hire, remuneration, or military aviation.

Ground control communication. ATC service communication provided for the purpose of:

- preventing collisions on the manoeuvring area between aircraft, aircraft and obstacles, or vehicles; and
- expediting and maintaining the orderly flow of aircraft operating on the manoeuvring area.

Private advisory service. A communication service offered at controlled aerodromes for use in connection with company business such as the servicing of aircraft, availability of fuel, lodging, etc.

Private multiple station. An aircraft or aeronautical station established to provide air-to-ground multi-purpose communication of an operational nature.

CONFIRMATION OF TEACHING POINT 3

QUESTIONS:

- Q1. What is an aircraft station?
- Q2. What is an aeronautical station?
- Q3. What is a controlled aerodrome?

ANTICIPATED ANSWERS:

- A1. A mobile station in the aeronautical service other than a survival craft located on board an aircraft.
- A2. A station located on land, on board a ship or on a platform at sea. It may be as simple as a hand-held radio.
- A3. An aerodrome at which an ATC service is provided.

Teaching Point 4

Describe radio station licences.

Time: 5 min

Method: Interactive Lecture

All radio stations in Canada must be licensed by Industry Canada. The licence specifies:

- call sign of the station,
- frequencies,
- special conditions,
- equipment, and
- fines.

Call Sign of the Station

A distinctive call sign is assigned to each radio station for identification purposes and should be used when initial contact is being established and again when the communication is concluded. Aeronautical call signs should always be pronounced phonetically.

Frequencies

The license will specify frequencies to be used for transmitting. The use of the frequency for activities includes:

- air-to-air,
- air-to-ground instructional, and
- air-to-ground aerodrome traffic communications.

Special Conditions

Each station receives conditions for operation, including: the tower size, interference, and special services.

Equipment

All radio equipment used in aeronautical services is required to be licensed by Industry Canada.

Fines

Any person who establishes a radio station without a radio authorization is liable to a fine not exceeding \$5 000, or imprisonment for a term not exceeding one year, or both.

A corporation may receive a fine not exceeding \$25 000.

CONFIRMATION OF TEACHING POINT 4**QUESTIONS:**

- Q1. Why is a call sign assigned?
- Q2. What does the licence specify about frequencies?
- Q3. What is required for all radio equipment used in aeronautical services?

ANTICIPATED ANSWERS:

- A1. A call sign is assigned for identification.
- A2. The licence specifies frequencies to be used for transmitting.
- A3. All radio equipment used in aeronautical services is required to be licensed by Industry Canada.

Teaching Point 5**Describe maintenance of equipment.**

Time: 5 min

Method: Interactive Lecture

Avionics or radio equipment capable of two-way communication with ground stations or airborne stations include:

- a transceiver (transmitter and a receiver),
- a speaker (headset),
- a microphone, and
- antenna.

Equipment must be maintained and precautions need to be taken to ensure the serviceability of the avionics.

Transceiver (transmitter and a receiver)

A transmitter and a receiver are usually combined and called a transceiver. The transceiver should be warm but not hot to the touch. A cooling kit draws cool air from outside the airplane and pumps it around the equipment.

Headset (speaker)

The speaker(s) are included in the headset. The headset cables should not be knotted but coiled loosely when not being used.

Microphone and Antenna Connections

Microphone and antenna connections vary with the equipment. There should be no shorts or open wires when assembling connectors. Connections should be tight and clean. Where connections are exposed to the weather, they should be protected with a coating of silicone to prevent corrosion and to keep water from getting inside the outer casing of the cable.

Fuses

Electric circuits are protected against overload and short circuits by fuses, each rated for a given amperage. Fuses act as a safety valve. Fuses should never be replaced with one of a higher rating.

CONFIRMATION OF TEACHING POINT 5**QUESTIONS:**

- Q1. Why should radio equipment be maintained and precautions taken?
- Q2. What precautions must be taken when assembling the microphone and antenna connections?
- Q3. What is the function of a fuse?

ANTICIPATED ANSWERS:

- A1. To ensure serviceability of the avionics.
 - A2. Ensure there are no shorts or open wires are present.
 - A3. Protects electric circuits against overload and short circuits.
-

END OF LESSON CONFIRMATION

QUESTIONS:

- Q1. Name the three parts of a wavelength.
- Q2. What two factors determine sky wave propagation?
- Q3. What does Flight Service Station (FSS) provide?

ANTICIPATED ANSWERS:

- A1. A wavelength consists of:
 - amplitude,
 - trough, and
 - crest.
 - A2. Radio frequency and the level of ionization.
 - A3. FSS provides service to pilots and other users including:
 - mobile and fixed communication,
 - airport advisory,
 - flight information,
 - search and rescue alerting,
 - weather, and
 - flight planning.
-

CONCLUSION

HOMEWORK / READING / PRACTICE

Nil.

METHOD OF EVALUATION

This EO is assessed IAW A-CR-CCP-804/PG-001 *Proficiency Level Four Qualification Standard and Plan*, Chapter 3, Annex B, 429 PC.

CLOSING STATEMENT

Being able to describe radio wavelengths, signals, licences and equipment provides a better understanding of radio theory and licencing procedures. This knowledge is required to obtain the Industry Canada Restricted Operator Certificate with Aeronautical Qualification (ROC-A).

INSTRUCTOR NOTES / REMARKS

If the squadron chooses to have cadets obtain the ROC-A, all complementary EOs for this PO must be instructed and a qualified examiner must conduct the 429 PC.

Cadets who are qualified Advanced Aviation may assist with this instruction.

REFERENCES

C3-116 ISBN 0-9680390-5-7 MacDonald, A. F., & Pepler, I. L. (2000). *From the ground up: Millennium edition*. Ottawa, ON: Aviation Publishers Co. Limited.

C3-182 *Study guide for the radiotelephone operator's restricted certificate (Aeronautical)*. (2008). Retrieved September 28, 2008, from www.ic.gc.ca/epic/site/smt-gst.nsf/en/sf01397e.html

THIS PAGE INTENTIONALLY LEFT BLANK

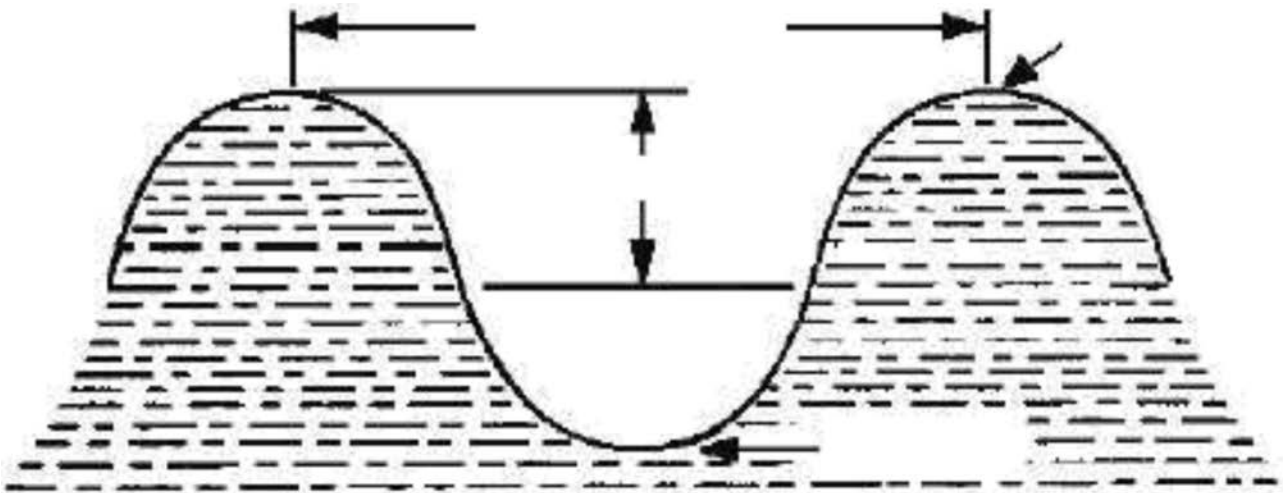

Figure A-1 Transverse Wavelength

Note. From Integrated Publishing, *Transverse Wave*. Retrieved October 31, 2008, from http://www.tpub.com/content/neets/14182/css/14182_17.htm

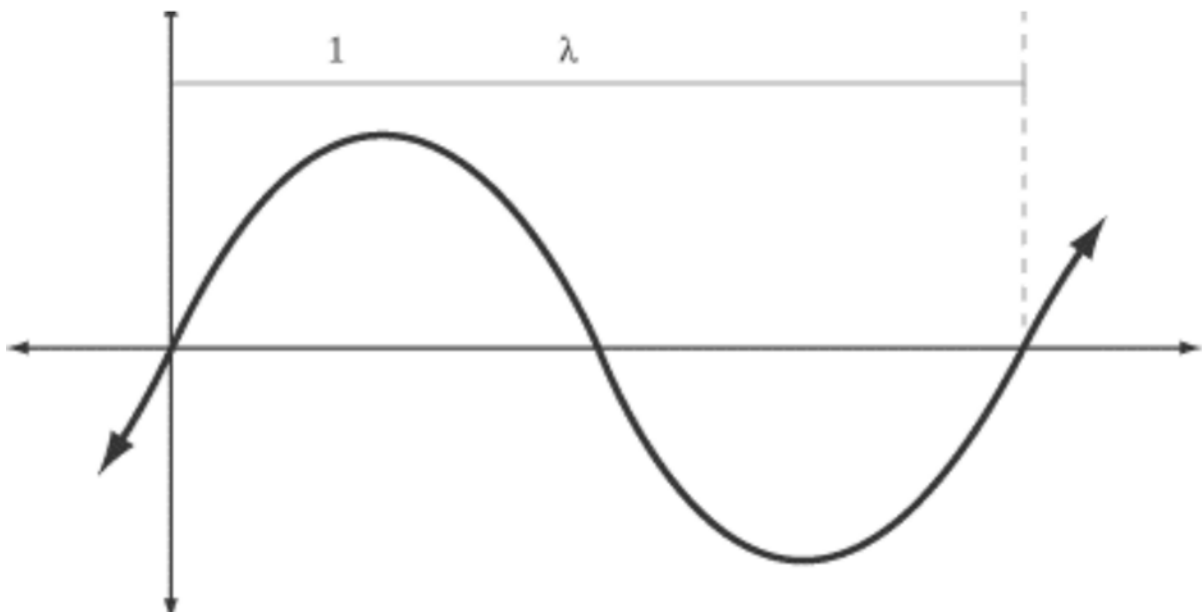

Figure A-2 Crest, Troughs and Trough

Note. From "SparkNotes", 2006, *Crests, Troughs, and Wavelength*. Retrieved October 24, 2008, from <http://sparknotes.com/testprep/books/sat2/physics/chapter17section2.shtml>

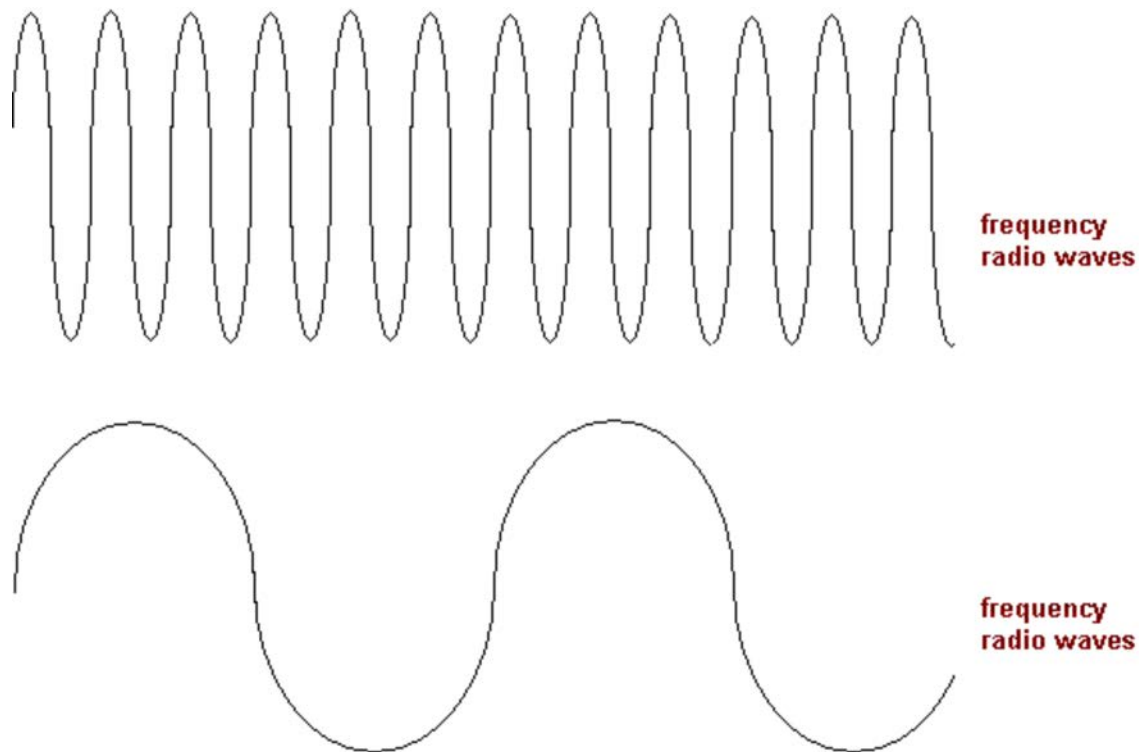

Figure A-3 Radio Wave Frequencies

Note. From "Communications System", *What is Frequency?* Retrieved October 24, 2008, from <http://qrg.northwestern.edu/project/vss/docs/Communications/1-what-is-frequency.html>

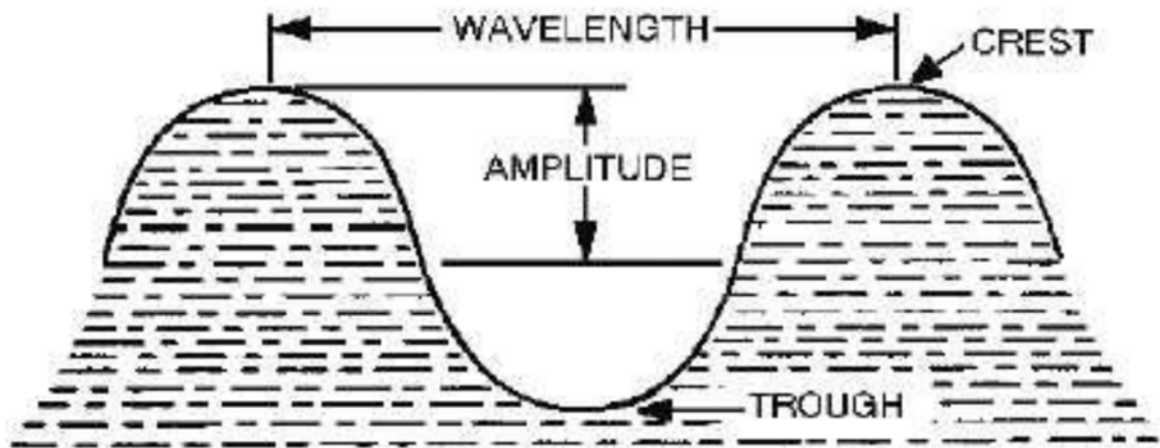

Figure B-1 Transverse Wavelength

Note. From Integrated Publishing, *Transverse Wave*. Retrieved October 31, 2008, from http://www.tpub.com/content/neets/14182/css/14182_17.htm

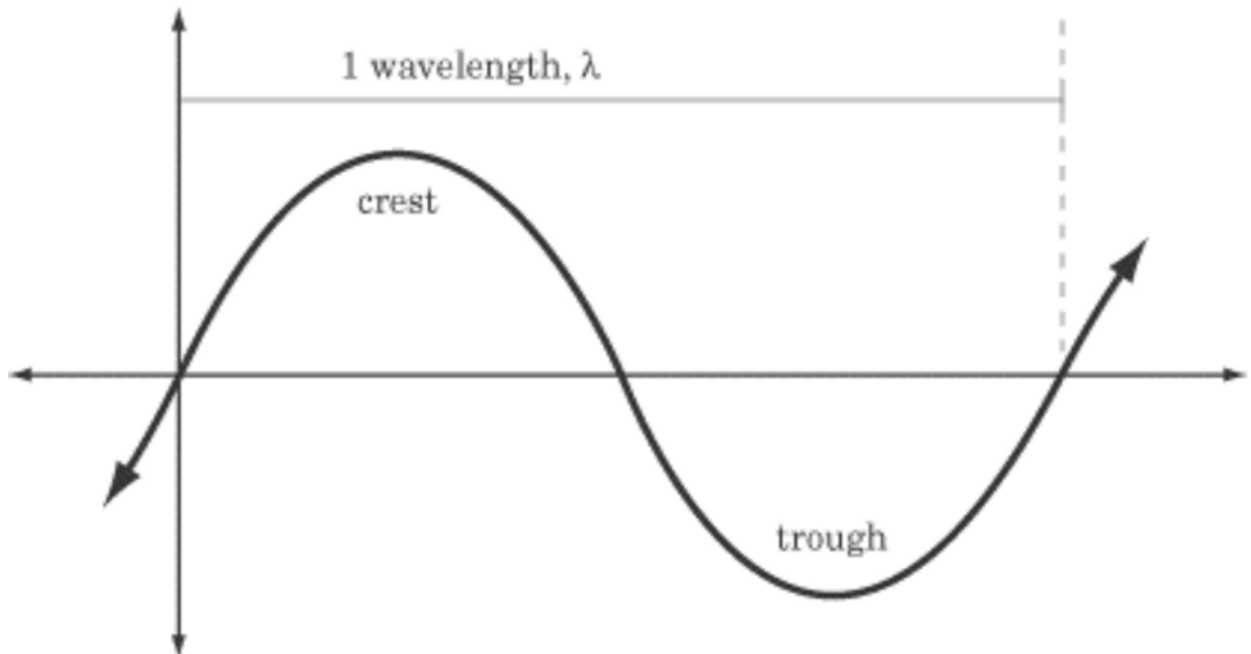

Figure B-2 Crest, Troughs and Trough

Note. From "SparkNotes", 2006, *Crests, Troughs, and Wavelength*. Retrieved October 24, 2008, from <http://sparknotes.com/testprep/books/sat2/physics/chapter17section2.rhtml>

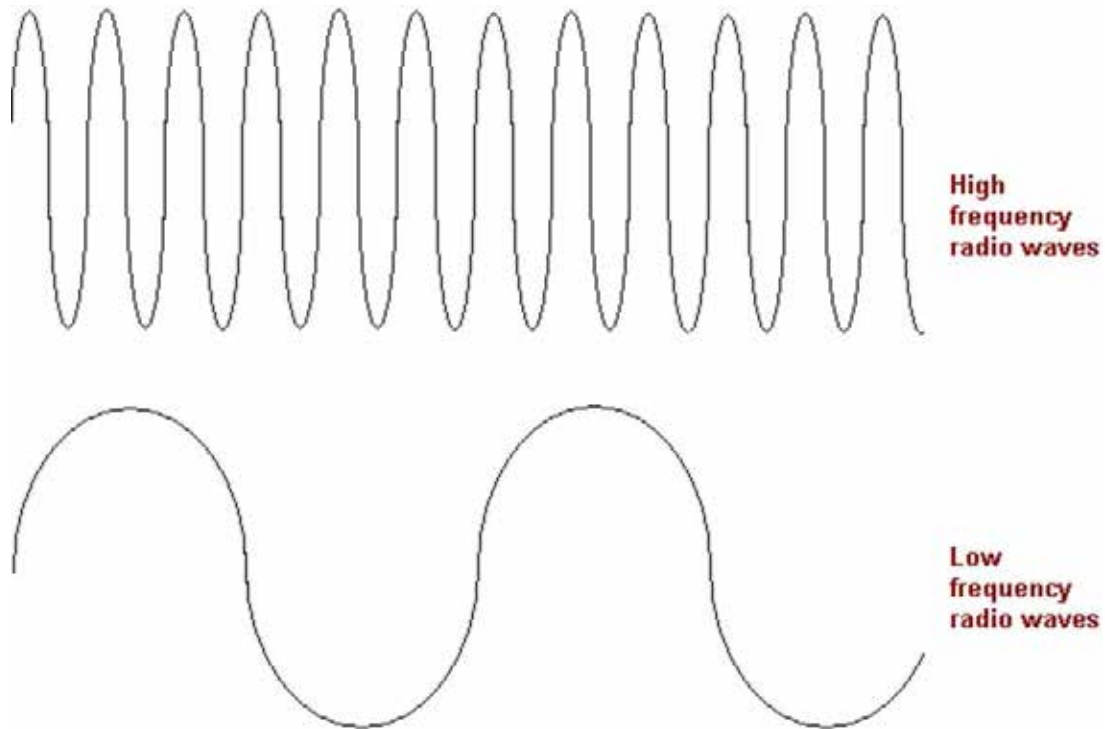

Figure B-3 Radio Wave Frequencies

Note. From "Communications System", *What is Frequency?* Retrieved October 24, 2008, from <http://qrg.northwestern.edu/project/vss/docs/Communications/1-what-is-frequency.html>

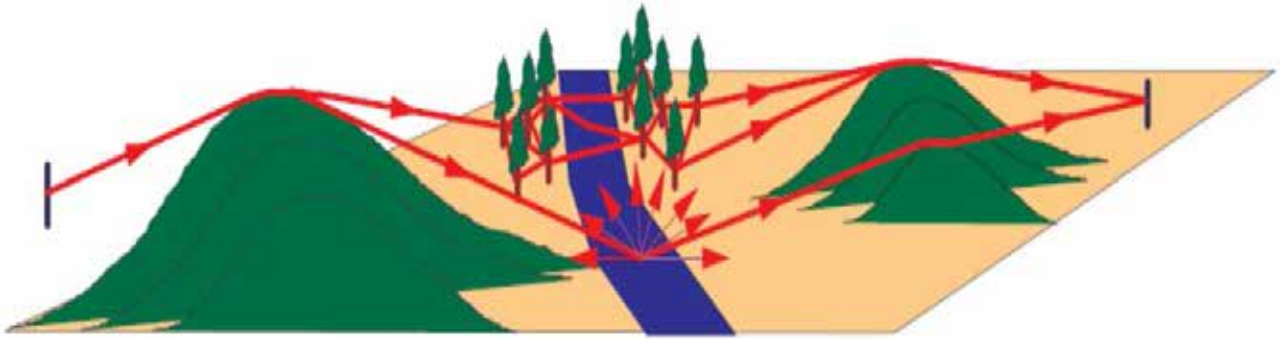

Figure C-1 Ground Wave Transmission

Note. From *Radio Wave Diffraction and Scattering Models for Wireless Channel Simulation* (p. 5), by M. Casciato, 2001, Michigan: USA. Copyright 2001 by M. Casciato. Retrieved October 31, 2008, from <http://www.eecs.umich.edu/RADLAB/html/NEWDISS/Casciato.pdf>

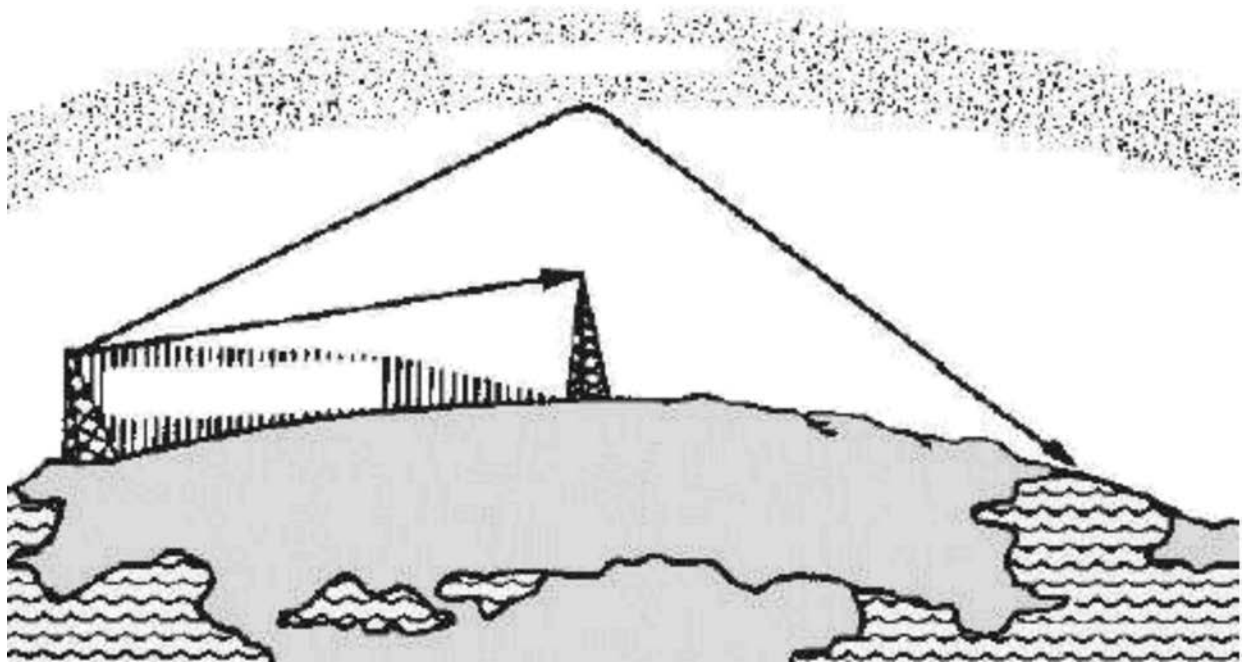

Figure C-2 Sky Wave Transmission

Note. From "Integrated Publishing", *Radio Wave Transmission*. Retrieved October 31, 2008, from http://www.tpub.com/content/neets/14182/css/14182_75.htm

THIS PAGE INTENTIONALLY LEFT BLANK

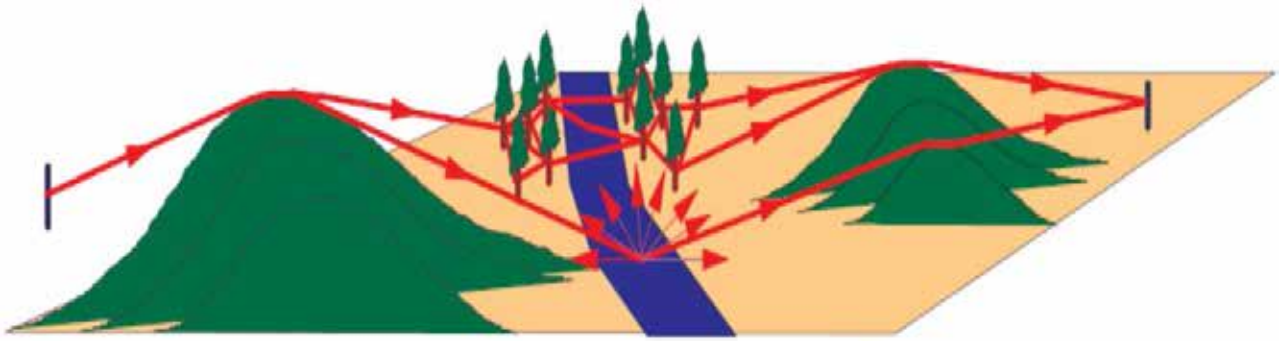

Figure D-1 Ground Wave Transmission

Note. From *Radio Wave Diffraction and Scattering Models for Wireless Channel Simulation* (p. 5), by M. Casciato, 2001, Michigan: USA. Copyright 2001 by M. Casciato. Retrieved October 31, 2008, from <http://www.eecs.umich.edu/RADLAB/html/NEWDISS/Casciato.pdf>

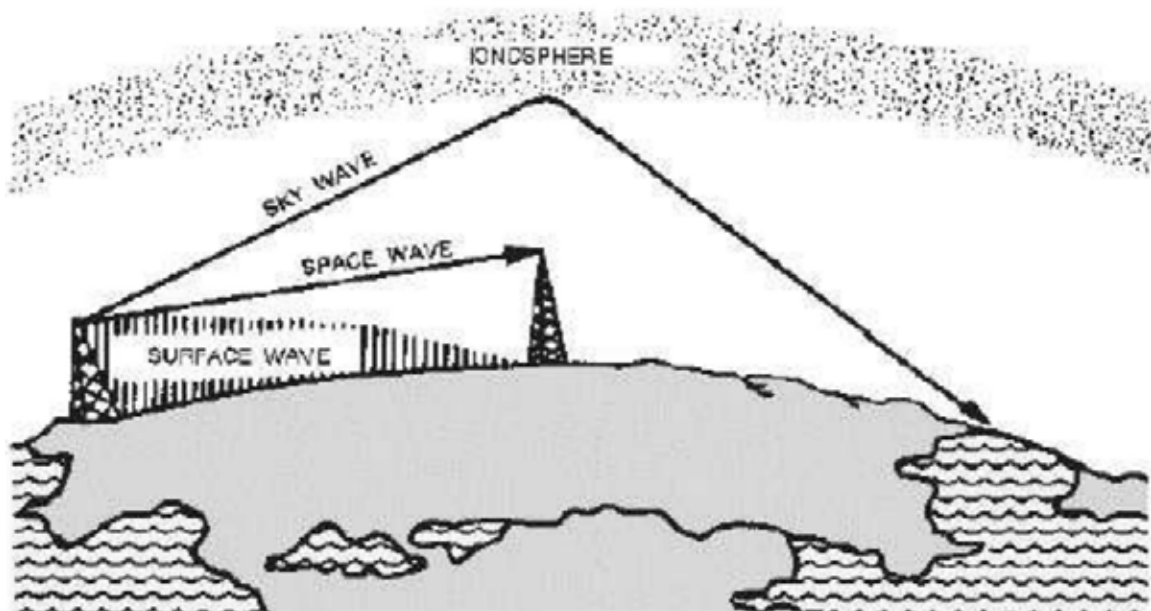

Figure D-2 Sky Wave Transmission

Note. From "Integrated Publishing", *Radio Wave Transmission*. Retrieved October 31, 2008, from http://www.tpub.com/content/neets/14182/css/14182_75.htm

THIS PAGE INTENTIONALLY LEFT BLANK



ROYAL CANADIAN AIR CADETS
PROFICIENCY LEVEL FOUR
INSTRUCTIONAL GUIDE



SECTION 4

EO C429.04 – EXPLAIN EMERGENCY, URGENCY AND SAFETY COMMUNICATIONS

Total Time:

30 min

PREPARATION

PRE-LESSON INSTRUCTIONS

Resources needed for the delivery of this lesson are listed in the lesson specification located in A-CR-CCP-804/PG-001, *Proficiency Level Four Qualification Standard and Plan*, Chapter 4. Specific uses for said resources are identified throughout the instructional guide within the TP for which they are required.

Review the lesson content and become familiar with the material prior to delivering the lesson.

PRE-LESSON ASSIGNMENT

Nil.

APPROACH

An interactive lecture was chosen for this lesson to clarify, emphasize, and summarize emergency, urgency and safety communications.

INTRODUCTION

REVIEW

Nil.

OBJECTIVES

By the end of this lesson the cadet shall have explained emergency, urgency and safety communications.

IMPORTANCE

It is important for cadets to explain emergency, urgency and safety communications as the information is recognized worldwide to request assistance. The information is required knowledge to obtain the Industry Canada Restricted Operator Certificate with Aeronautical Qualification (ROC-A).

Teaching Point 1**Explain emergency communications.**

Time: 15 min

Method: Interactive Lecture

EMERGENCY COMMUNICATIONS**Distress Call**

A distress call is defined as a situation of serious and / or imminent danger that requires immediate assistance. A distress call is sent by saying:

1. MAYDAY spoken three times,
2. THIS IS, and
3. the call sign of the aircraft in distress spoken three times.



Distress situations include:

- fire,
- engine failure, and
- explosive decompression.

Example:

MAYDAY, MAYDAY, MAYDAY,
THIS IS,
PIPER FOXTROT ALFA BRAVO CHARLIE,
PIPER FOXTROT ALFA BRAVO CHARLIE,
PIPER FOXTROT ALFA BRAVO CHARLIE.

Priority

A distress call has absolute priority over all other transmissions.

Frequencies to Use

The initial distress call should be made on the air-to-ground frequency that is in use at the time. If the station in distress cannot make contact on the initial air-to-ground frequency, attempt to make contact on the general distress frequency (121.50 MHz, 243 MHz or 3023.5 kHz) and then any other frequency that is available. If changing frequency, state which frequency is being changed to before leaving the first frequency.

Distress Message

The distress message shall follow the distress call as soon as possible. The message shall include as much information as possible, in the following order:

1. the distress signal MAYDAY once,
2. the call sign of the aircraft in distress once,
3. the nature of the distress condition and what assistance is required,
4. the intentions of the person in command,
5. the aircraft details including its position, airspeed, altitude, and heading,

6. the number of people on board and any injuries,
7. any other information which might assist the rescue, and
8. the call sign of the aircraft in distress.

Example:

MAYDAY,
 PIPER FOXTROT ALFA BRAVO CHARLIE,
 STRUCK BY LIGHTNING,
 DITCHING AIRCRAFT,
 POSITION: 20 MILES EAST OF WINNIPEG,
 ALTITUDE: WUN TOUSAND FIFE ZERO ZERO FEET,
 AIRSPEED: WUN TOO FIFE KNOTS,
 HEADING: TOO SEVEN ZERO DEGREES,
 ONE PERSON ON BOARD,
 PIPER FOXTROT ALFA BRAVO CHARLIE.

Repetition of Distress Message

The distress message shall be repeated at intervals by the aircraft in distress until an answer is received or until it is no longer safe / possible to continue sending the message.

Action by Station in Distress

A person in command of an aircraft in distress shall direct the following actions:

1. transmit the distress call;
2. transmit the distress message;
3. listen for acknowledgement of message receipt;
4. exchange further distress information as applicable; and
5. activate automatic emergency equipment (eg, emergency locator transmitter [ELT]) if available and when appropriate.

Action by Stations Other Than the Station in Distress

An aircraft that is not in distress shall transmit the distress message when:

1. the aircraft in distress is not in a position to transmit the message;
2. the person in command of the aircraft not in distress believes that further help is necessary; and
3. the aircraft heard a distress message that has not been acknowledged.



When a distress message has been heard and the aircraft in distress is not in the immediate vicinity, allow time for stations nearer to the aircraft in distress to reply.

Stations hearing a distress message shall:

- continue to monitor the frequency on which the distress message was received;
- establish a continuous watch on appropriate distress and emergency frequencies;

- notify stations with direction finding or radar facilities and request assistance unless it is known that the action has been taken by the station acknowledging receipt of the distress message; and
- cease transmissions which interfere with the distress traffic.

Distress Traffic



Distress traffic is all transmissions relative to the immediate assistance required by the station in distress including all transmissions after the initial distress call.

The distress signal MAYDAY spoken once shall precede all distress traffic.



For stations not aware of the distress call, starting the message with the word MAYDAY will alert the stations of a distress situation. All stations will monitor the distress channel on which the distress call originated.

Any aircraft that has knowledge of the distress traffic and cannot assist the station in distress shall follow the traffic until it is evident that assistance is being provided.

All stations that are aware of the distress traffic and are not participating in the traffic are forbidden to transmit on the frequencies.



Communication can continue once a message has been received indicating that normal working traffic has resumed.

Acknowledgement of Receipt of a Distress Message

A station responding to a distress message shall acknowledge the message in the following form:

1. the distress signal MAYDAY;
2. the call sign of the station in distress spoken three times;
3. the phrase THIS IS;
4. the call sign of the station acknowledging receipt spoken three times; and
5. the words RECEIVED MAYDAY.

Example:

MAYDAY, MAYDAY, MAYDAY,
PIPER FOXTROT ALFA BRAVO CHARLIE,
PIPER FOXTROT ALFA BRAVO CHARLIE,
PIPER FOXTROT ALFA BRAVO CHARLIE,
THIS IS,
WINNIPEG TOWER,
WINNIPEG TOWER,
WINNIPEG TOWER,
RECEIVED MAYDAY.

Action by Stations Acknowledging Receipt of a Distress Message

Once the station has acknowledged the distress message, the station shall take the following actions:

1. taking control of the communications or clearly transferring the responsibility and informing the aircraft if a transfer is made;
2. taking immediate action to ensure all necessary information is provided as soon as possible to the air traffic service (ATS) unit concerned and the aircraft operating agency or representative concerned;
3. continuing to monitor the frequency on which the distress message was received and if possible any other frequency that may be used by the aircraft in distress;
4. warning other stations in order to prevent the transfer of aeronautical traffic to the frequency or the distress communication; and
5. ceasing all transmissions that may interfere with the distress traffic.

Relay of a Distress Message

If a distress message is repeated by an aircraft or station other than the aircraft in distress, the message will be comprised of:

- the signal MAYDAY RELAY spoken three times;
- the phrase THIS IS;
- the call sign of the station relaying the message spoken three times;
- the distress signal MAYDAY spoken once; and
- the details of the aircraft in distress, to include:
 - the call sign of the aircraft in distress spoken once;
 - the nature of the distress;
 - the action being taken;
 - its location;
 - the number of people on board; and
 - the call sign of the aircraft in distress spoken once.

Example:

MAYDAY RELAY, MAYDAY RELAY, MAYDAY RELAY,
THIS IS,
CESSNA GOLF SIERRA ROMEO TANGO,
CESSNA GOLF SIERRA ROMEO TANGO,
CESSNA GOLF SIERRA ROMEO TANGO,
MAYDAY,
PIPER FOXTROT ALFA BRAVO CHARLIE,
STRUCK BY LIGHTNING,
FORCED LANDING AIRCRAFT,
POSITION: 20 MILES EAST OF WINNIPEG,
ALTITUDE: WUN TOUSAND FIFE ZERO ZERO FEET,
AIRSPEED: WUN TOO FIFE KNOTS,
HEADING: TOO SEVEN ZERO DEGREES,
ONE PERSON ON BOARD,
PIPER FOXTROT ALFA BRAVO CHARLIE.

Imposition of Silence

Silence shall be imposed on all stations or individual stations in the area that are interfering with the distress traffic. The aircraft in distress or the station in control of distress traffic shall use the expression SEELONCE MAYDAY. Other stations near the aircraft in distress may impose silence during a distress situation by using the international expression SEELONCE DISTRESS.

All transmissions will cease immediately except for those involved in the distress traffic.

Example:

The aircraft in distress imposing silence to a specific station:

CHEROKEE GOLF OSCAR OSCAR PAPA,
THIS IS,
PIPER FOXTROT ALFA BRAVO CHARLIE,
SEELONCE MAYDAY,
OUT.

A station other than the aircraft in distress imposing silence to all stations:

ALL STATIONS, ALL STATIONS, ALL STATIONS,
THIS IS,
CHEROKEE GOLF OSCAR OSCAR PAPA,
SEELONCE DISTRESS,
OUT.

Cancellation of Distress

When the distress situation or when radio silence has ended, the station controlling the distress traffic shall transmit a message addressed to all stations on all frequencies used, advising that normal communication may resume. The message cancelling the distress message includes:

1. the distress signal MAYDAY spoken once;
2. the phrase HELLO ALL STATIONS spoken three times;
3. the phrase THIS IS;
4. the call sign of the station transmitting the message;
5. the filing time of the message;

6. the call sign of the station in distress spoken once;
7. the words SEELONCE FEENEE; and
8. the word OUT.

Example:

MAYDAY,
HELLO ALL STATIONS, HELLO ALL STATIONS, HELLO ALL STATIONS,
THIS IS,
WINNIPEG TOWER,
TIME WUN SIX TREE ZERO ZULU,
PIPER FOXTROT ALPHA BRAVO CHARLIE,
SEELONCE FEENEE,
OUT.



Ensure that search and rescue stations are advised that a station is no longer in distress by making a normal call to the nearest aeronautical station detailing the reasons for cancelling the distress call.

CONFIRMATION OF TEACHING POINT 1

QUESTIONS:

- Q1. Define a distress call.
- Q2. What is included in a distress call?
- Q3. What words are used to impose silence by the aircraft in distress?

ANTICIPATED ANSWERS:

- A1. A situation of serious and / or imminent danger that requires immediate assistance.
- A2. A distress call includes:
 - MAYDAY spoken three times,
 - THIS IS, and
 - call sign of aircraft in distress spoken three times.
- A3. SEELONCE MAYDAY.

Teaching Point 2**Explain urgency and safety communications.**

Time: 10 min

Method: Interactive Lecture

URGENCY AND SAFETY COMMUNICATIONS**Urgency Call**

An urgency call is defined as a message from a station having a very urgent transmission but does not require immediate assistance, concerning the safety of:

- an aircraft, ship, or other vehicle, and
- a person.



The urgency call shall only be sent on the authority of the person in charge including situations involving:

- being lost;
- minor mechanical problems;
- serious health issues involving an individual on board; and
- security issues involving an individual on board.

The urgency call is sent using the words PAN PAN spoken three times at the beginning of the first urgency communication.

Priority

An urgency call has priority over all other transmissions except emergency (distress) calls.

All stations that hear the urgency call shall continue to listen for at least three minutes on the frequency which the signal was heard. After three minutes, and if no further message is heard, all stations can resume communications as normal.



Stations that are in communication on frequencies other than those used for the transmission of the urgency message may continue normal work without interruption unless the urgency message is addressed to all stations.

Frequencies to Use

The initial urgency call and message should be made on the air-to-ground frequency that is in use at the time. If the station in difficulty cannot make contact on the initial air-to-ground frequency, it shall attempt to make contact on the general aeronautical emergency frequency (121.50 MHz or 3023.5 kHz) or any frequency that is available to make contact with any aeronautical ground or aircraft station.

Urgency Message

The urgency call shall be followed by the urgency message. The message shall include further information including as many as possible, in the following order:

1. the urgency call PAN PAN spoken three times;
2. the call sign of the aircraft, station, or ALL STATIONS spoken three times;

3. the phrase THIS IS;
4. the call sign of the aircraft or station making the urgency call;
5. the nature of the urgency condition;
6. the intentions of the person in command;
7. the aircraft particulars of its position (airspeed, altitude, and heading);
8. any other useful information;
9. the call sign of the aircraft in distress; and
10. the word OVER.

Example:

PAN PAN, PAN PAN, PAN PAN,
ALL STATIONS, ALL STATIONS, ALL STATIONS,
THIS IS,
PIPER FOXTROT ALFA BRAVO CHARLIE,
LOST, REQUEST RADAR CHECK,
POSITION: UNKNOWN,
ALTITUDE: WUN TOUSAND FIFE HUNDRED FEET,
AIRSPEED: WUN TOO FIFE KNOTS,
HEADING: TOO SEVEN ZERO DEGREES,
PIPER FOXTROT ALFA BRAVO CHARLIE,
OVER.

Reply to Urgency Message

When the urgency message is addressed to all stations and is acknowledged by another aircraft or station, the acknowledging station shall forward the urgency information to the appropriate authorities.

Example:

PAN PAN,
PIPER FOXTROT ALFA BRAVO CHARLIE,
THIS IS WINNIPEG TOWER,
YOUR POSITION IS 28 MILES EAST WINNIPEG,
WINNIPEG TOWER,
STANDING BY.

Cancellation of Urgency Message

As soon as it is known that the action is no longer necessary, the cancellation message shall be directed to ALL STATIONS by the station responsible for the urgency message transmission.

Example:

PAN PAN,
HELLO ALL STATIONS, HELLO ALL STATIONS, HELLO ALL STATIONS,
THIS IS,
PIPER FOXTROT ALFA BRAVO CHARLIE,
PIPER FOXTROT ALFA BRAVO CHARLIE,
PIPER FOXTROT ALFA BRAVO CHARLIE,
28 MILES EAST OF WINNIPEG AIRPORT PROCEEDING NORMALLY,
PIPER FOXTROT ALFA BRAVO CHARLIE,
OUT.

Safety Signal

Aircraft or stations transmitting the safety signal SECURITE will then transmit a message to aircraft in flight, concerning:

- the safety of navigation, or
- important meteorological warnings.

The safety signal has priority over all communications except distress and urgency.

The safety signal SECURITE is spoken three times at the start of the message addressed to ALL STATIONS.

Example:

SECURITE, SECURITE, SECURITE,
ALL STATIONS, ALL STATIONS, ALL STATIONS,
THIS IS,
PIPER FOXTROT NOVEMBER KILO ECHO,
NOTICE TO ALL STATIONS IN AREA,
30 MILES EAST OF OTTAWA,
UNMANNED BALLOON DRIFTING,
PIPER FOXTROT NOVEMBER KILO ECHO,
OUT.

CONFIRMATION OF TEACHING POINT 2

QUESTIONS:

- Q1. Define an urgency call.
- Q2. What word is repeated three times for an urgency call?
- Q3. What word is repeated three times for the safety signal?

ANTICIPATED ANSWERS:

- A1. A message from a station having a very urgent transmission but does not require immediate assistance, concerning the safety of:
 - an aircraft, ship, or other vehicle, and
 - a person.

- A2. PAN PAN.
A3. SECURITE.

END OF LESSON CONFIRMATION**QUESTIONS:**

- Q1. What calls have absolute priority over all other communication?
Q2. On what frequency should the initial distress call be made?
Q3. To whom is the cancellation message directed?

ANTICIPATED ANSWERS:

- A1. Distress.
A2. The air-to-ground frequency being used at the time.
A3. ALL STATIONS.

CONCLUSION

HOMEWORK / READING / PRACTICE

Nil.

METHOD OF EVALUATION

This EO is assessed IAW A-CR-CCP-804/PG-001 *Proficiency Level Four Qualification Standard and Plan*, Chapter 3, Annex B, 429 PC.

CLOSING STATEMENT

The ability to explain emergency, urgency and safety communications demonstrates the cadets understanding of the worldwide request for assistance. This knowledge is required to obtain the IC ROC-A.

INSTRUCTOR NOTES / REMARKS

If the squadron chooses to have cadets obtain the ROC-A, all complementary EOs must be conducted and a qualified examiner must conduct the 429 PC

Cadets who are qualified Advanced Aviation may assist with this instruction.

REFERENCES

C3-116 ISBN 0-9680390-5-7 MacDonald, A. F., & Peppler, I. L. (2000). *From the ground up: Millennium edition*. Ottawa, ON: Aviation Publishers Co. Limited.

C3-182 *Study Guide for the Radiotelephone Operator's Restricted Certificate (Aeronautical)*. (2008). Retrieved September 28, 2008, from www.ic.gc.ca/epic/site/smt-gst.nsf/en/sf01397e.htm

THIS PAGE INTENTIONALLY LEFT BLANK



ROYAL CANADIAN AIR CADETS
PROFICIENCY LEVEL FOUR
INSTRUCTIONAL GUIDE



SECTION 1

EO M431.01 – EXPLAIN FEATURES OF WING DESIGN

Total Time:

30 min

PREPARATION

PRE-LESSON INSTRUCTIONS

Resources needed for the delivery of this lesson are listed in the lesson specification located in A-CR-CCP-804/PG-001, *Proficiency Level Four Qualification Standard and Plan*, Chapter 4. Specific uses for said resources are identified throughout the instructional guide within the TP for which they are required.

Review the lesson content and become familiar with the material prior to delivering the lesson.

Obtain a model of a light fixed-wing aircraft with wing struts, fixed gear and control surface detail.

Prepare slides of the figures located at Attachment A.

Obtain a model of a wing.

PRE-LESSON ASSIGNMENT

Nil.

APPROACH

An interactive lecture was chosen for this lesson to clarify, emphasize, and summarize features of wing design.

INTRODUCTION

REVIEW

Nil.

OBJECTIVES

By the end of this lesson the cadet shall be expected to explain features of wing design.

IMPORTANCE

It is important for cadets to be able to explain features of wing design as it directly relates to the production of lift by the wing. Being able to explain features of wing design provides knowledge for potential instructional duties and is part of the fundamentals that cadets pursuing future aviation training will require.



Use the model aircraft with articulated control surfaces and flaps throughout this lesson to illustrate features of wing design as they are discussed.

Teaching Point 1

Explain airfoils.

Time: 10 min

Method: Interactive Lecture

AIRFOILS

Chord. An imaginary straight line joining the leading and trailing edges of the wing. The mean aerodynamic chord (MAC) is the average chord of the wing.

The shape and design of the wing is directly influenced by the intended purpose of the aircraft. Aircraft designed to fly slowly typically have thick airfoils, while aircraft designed to fly fast have thin airfoils.



Show the slide of Figure A-1 to the cadets.

The very thin layer of air lying over the surface of the wing is called the boundary layer. At the front of the wing, the boundary layer flows smoothly over the surface and this area is called the laminar layer. As the air flows further along the wing, it slows down due to skin friction, the layer becomes thicker, and it becomes turbulent. The turbulent area is called the turbulent layer.

The transition point between the laminar and turbulent areas tends to move forward as airspeed and the angle of attack increase.

Conventional Airfoils

Conventional airfoils generally are the thickest at 25 percent of the chord and can be found in a variety of shapes and designs.



Show the slide of Figure A-2 to the cadets and describe the different airfoil shapes.

Laminar Flow Airfoils

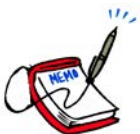

Show the slide of Figure A-3 to the cadets and show the differences between conventional and laminar flow airfoil shapes.

Laminar flow airfoils have their thickest point at 50 percent of the chord, a leading edge that is more pointed and upper and lower surfaces that are nearly symmetrical. Originally developed to make aircraft fly faster, they can be found on many different aircraft types.



The design of the laminar flow airfoil reduces drag by maintaining the laminar flow of air throughout a greater percentage of the chord. The pressure distribution is more even, but the transition point moves forward more rapidly near the point of stall.

Planform



Show the slide of Figure A-4 to the cadets.

The shape of the wing as seen from directly above is called the planform. The three general wing shapes are:

- rectangular,
- elliptical (rounded), and
- delta (swept).

Aspect ratio. The relationship between the length of the wing and its width (chord). It is calculated by dividing the span by the average chord.

A wing with a high aspect ratio generates more lift with less induced drag than a wing with the same wing area and a low aspect ratio. High aspect ratio wings are commonly found on gliders.

Angle of Incidence



Show the slide of Figure A-5 to the cadets.

The angle of incidence is the angle at which the wing is permanently inclined to the longitudinal axis of the aircraft.

The angle of incidence affects the following items:

- flight visibility,
- takeoff and landing characteristics, and
- amount of drag in level flight.

Wash-Out and Wash-In

To reduce the tendency of the wing to stall suddenly, the wing can be designed so that the angle of incidence at the wing tip is different than the angle of incidence at the wing root.



Show the slide of Figure A-6 to the cadets.

The twist in the wing causes the tip and root to stall at slightly different angles of attack and improves the stall characteristics. If the wing root stalls before the wing tip, the ailerons, located closer to the wing tip, can still be effective during the early part of the stall.

Decreasing the angle of incidence at the wing tip is called wash-out and increasing the angle is called wash-in.

CONFIRMATION OF TEACHING POINT 1

QUESTIONS:

- Q1. What happens to the transition point as airspeed and angle of attack increase?
- Q2. What is the aspect ratio of a wing?
- Q3. What is it called when the angle of incidence at the wing tip is decreased?

ANTICIPATED ANSWERS:

- A1. The transition point moves forward.
- A2. The relationship between the length of the wing and its width (chord). It is computed by dividing the span by the average chord.
- A3. Wash-out.

Teaching Point 2

Explain high-lift devices.

Time: 10 min

Method: Interactive Lecture

HIGH-LIFT DEVICES

The efficiency of a wing can be improved by either increasing the amount of lift generated, or by decreasing the amount of induced drag created. High-lift devices can be used individually or in various combinations to create a very efficient wing.

Although great gains in efficiency can be realized by adding these devices to a wing, there are penalties to pay, such as increased weight and increased mechanical complexity.

Wing Tip Design

Induced drag can be reduced by limiting the formation of wing tip vortices. This is done by preventing air from spilling over the wing tip by modifying the wing tips in one of the following ways:

- installing wing tip fuel tanks,
- using wing tip plates or winglets, and
- drooping the wing tips.

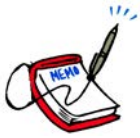

Show Figures A-7 and A-8 to the cadets.

Wing Fences



Show the slide of Figure A-9 to the cadets. Wing fences can also be seen in Figure A-8.

Wing fences are vertical surfaces attached to the upper surface of the wing. They act as guides and control the direction of airflow over the wing, especially at high angles of attack. This improves low-speed handling and stall characteristics.

Slats



Show the slide of Figure A-10 to the cadets.

Auxiliary airfoils that automatically move out in front of the leading edge at high angles of attack are known as slats. The resulting opening changes the airflow over the leading edge, smoothing out eddies that form on the top of the wing.

Slots



Show the slide of Figure A-11 to the cadets. Slots can also be seen in Figure A-10.

Slots affect the airflow in the same way as slats, except that they are passageways built into the wing. Slots can either be full- or partial-span.



Slats are moving devices. Slots are built into the wing and do not move.

Flaps

The most common high-lift device found on a wing is the flap. Located at the trailing edge, their primary purpose is to increase lift by changing the camber of the wing. Some styles of flaps also increase the effective wing area. The increased lift causes a lower stall speed and allows the aircraft to approach at a slower airspeed.



Show the slide of Figure A-12 to the cadets.

With a small amount of flap deflection, the amount of extra lift produced is greater than the amount of extra drag. As the amount of deflection increases, the amount of extra drag catches up to and passes the amount of extra lift being generated. The extra drag produced can be used to improve landing capabilities by slowing the aircraft down and creating a steeper approach angle (useful in approaching a runway with obstacles near the threshold).



Show the slide of Figure A-13 to the cadets.

Generally, the amount of drag produced by flaps reduces acceleration to the point where flaps should not be deployed during takeoff (as is the case with plain and split flaps). Slotted, Zap, and Fowler flaps produce more lift than drag at small amounts of deflection (5–15 degrees) and are usually recommended for takeoff.



In some aircraft, landing with full flaps and a crosswind is not recommended as the flaps may disrupt the airflow over the tail surfaces and make it difficult to control the aircraft during the ground roll.

CONFIRMATION OF TEACHING POINT 2

QUESTIONS:

- Q1. How can induced drag be reduced by wing tip design?
- Q2. What is the main difference between slats and slots?
- Q3. What do flaps increase?

ANTICIPATED ANSWERS:

- A1. Induced drag can be reduced by:
 - installing wing tip fuel tanks,
 - using wing tip plates or winglets, and
 - drooping the wing tips.
- A2. Slats are moving devices. Slots are built into the wing and do not move.
- A3. Flaps increase lift and drag. They may also increase the effective wing area.

Teaching Point 3**Explain spoilers and speed brakes.**

Time: 5 min

Method: Interactive Lecture



Show the slide of Figure A-14 to the cadets.

SPOILERS

Spoilers are devices on a wing that are used to decrease the lift and increase the drag being produced. They work by being extended up from the top surface of the wing and disrupting the airflow. Spoilers are found on almost all types of gliders and are used to increase the rate of descent during the landing approach.

Spoilers can also be used to supplement aileron control or replace ailerons completely. A deployed spoiler has the same effect as an up-going aileron, causing the aircraft to bank to that side.

SPEED BRAKES

Speed (dive) brakes are devices that are extended into the airflow, creating drag, with minimal effect on the lift being produced. Speed brakes allow aircraft to slow down without reducing thrust, and to control approach angles.

Speed brakes may be plates that extend out of a wing or hinged doors that open out from the fuselage.



Most gliders have speed brakes that extend out of the bottom of the wing.

CONFIRMATION OF TEACHING POINT 3**QUESTIONS:**

- Q1. Where are spoilers located?
- Q2. What control surface can spoilers supplement or replace?
- Q3. What do speed brakes create?

ANTICIPATED ANSWERS:

- A1. On the top surface of a wing.
- A2. Ailerons.
- A3. Drag.

END OF LESSON CONFIRMATION

QUESTIONS:

- Q1. What is the chord?
- Q2. How can adding devices negatively affect a wing?
- Q3. What do spoilers increase during the landing approach of most gliders?

ANTICIPATED ANSWERS:

- A1. An imaginary straight line joining the leading and trailing edges of the wing.
- A2. They create increased weight and mechanical complexity.
- A3. The rate of descent.

CONCLUSION

HOMEWORK / READING / PRACTICE

Nil.

METHOD OF EVALUATION

This EO is assessed IAW A-CRR-CCP-804/PG-001, *Proficiency Level Four Qualification Standard and Plan*, Chapter 3, Annex B, Aviation Subjects–Combined Assessment PC.

CLOSING STATEMENT

Understanding wing design, the features that improve the efficiency of the wing and devices that produce drag to control the approach angle provides knowledge for potential instructional duties and is part of the fundamentals that cadets pursuing future aviation training will require.

INSTRUCTOR NOTES / REMARKS

Cadets who are qualified Advanced Aviation may assist with this instruction.

REFERENCES

C3-116 ISBN 0-9680390-5-7 MacDonald, A. F., & Pepler, I. L. (2000). *From the ground up: Millennium edition*. Ottawa, ON: Aviation Publishers Co. Limited.

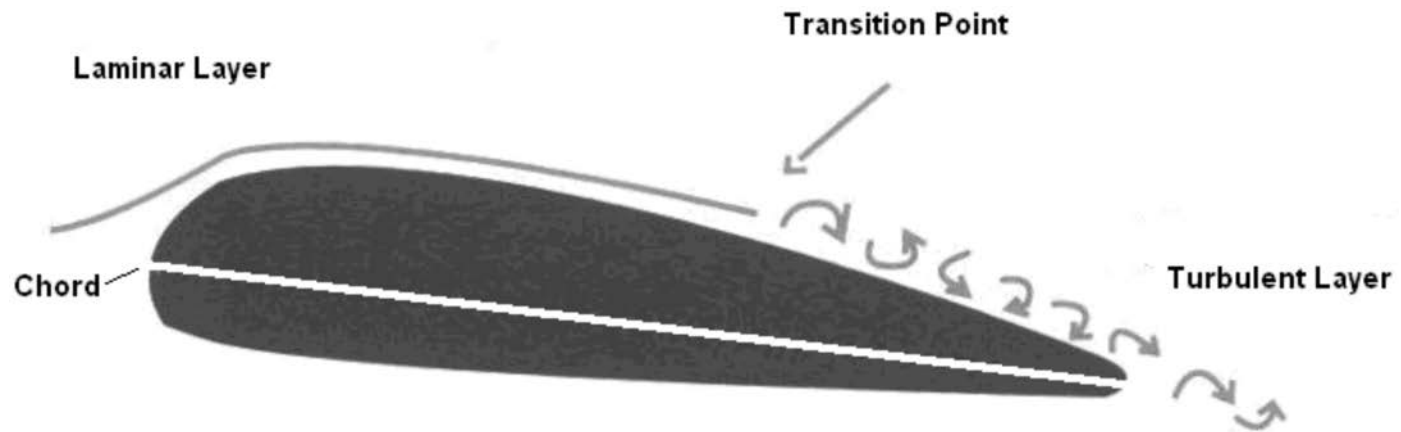

Figure A-1 Laminar and Turbulent Layers

Note. From *From the Ground Up: Millennium Edition* (p. 25), by A. F. MacDonald and I. L. Pepler, 2000, Ottawa, ON: Aviation Publishers Co. Limited. Copyright 2000 by Aviation Publishers Co. Limited.

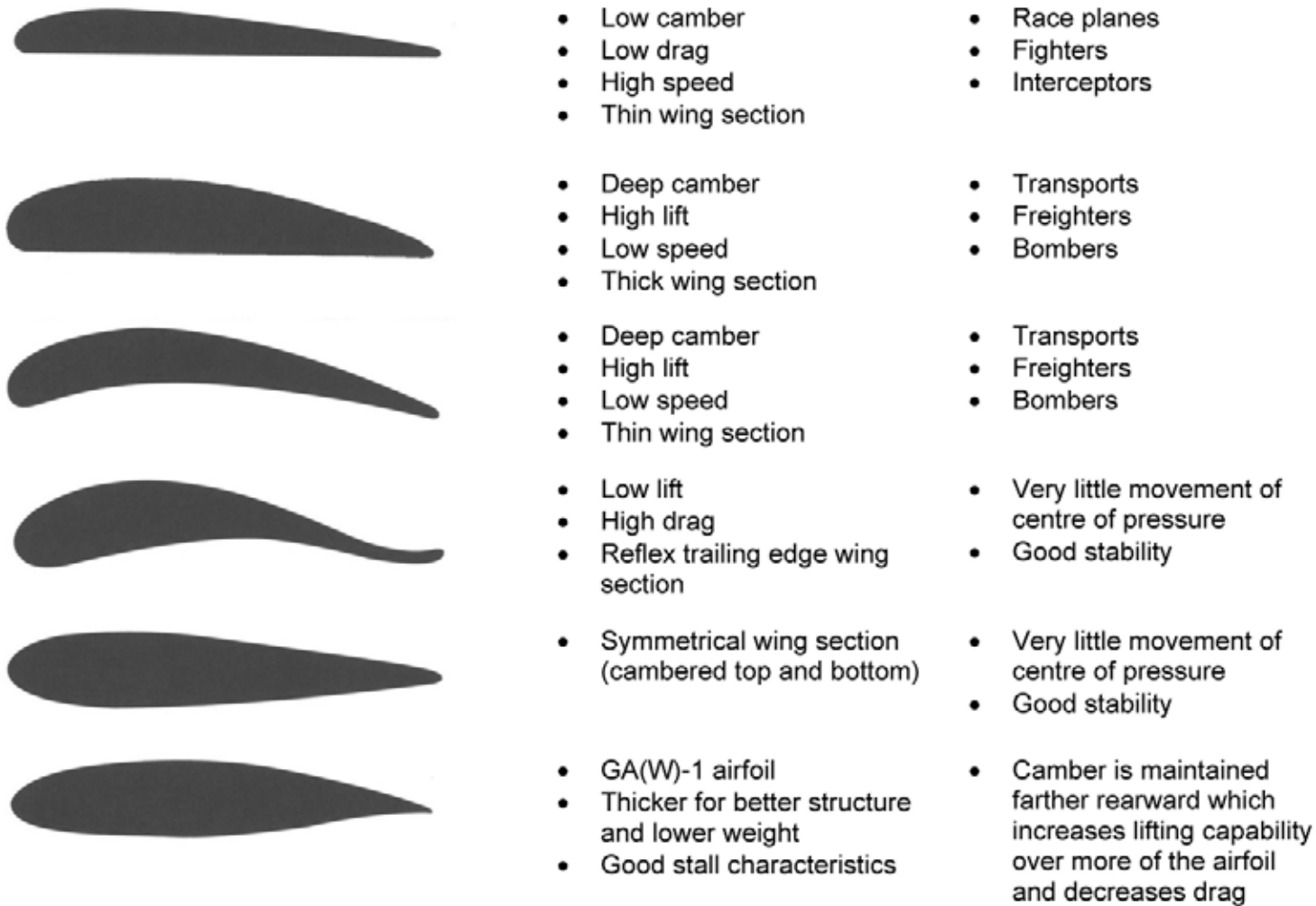

Figure A-2 Airfoil Sections

Note. From *From the Ground Up: Millennium Edition* (p. 26), by A. F. MacDonald and I. L. Peppler, 2000, Ottawa, ON: Aviation Publishers Co. Limited. Copyright 2000 by Aviation Publishers Co. Limited.

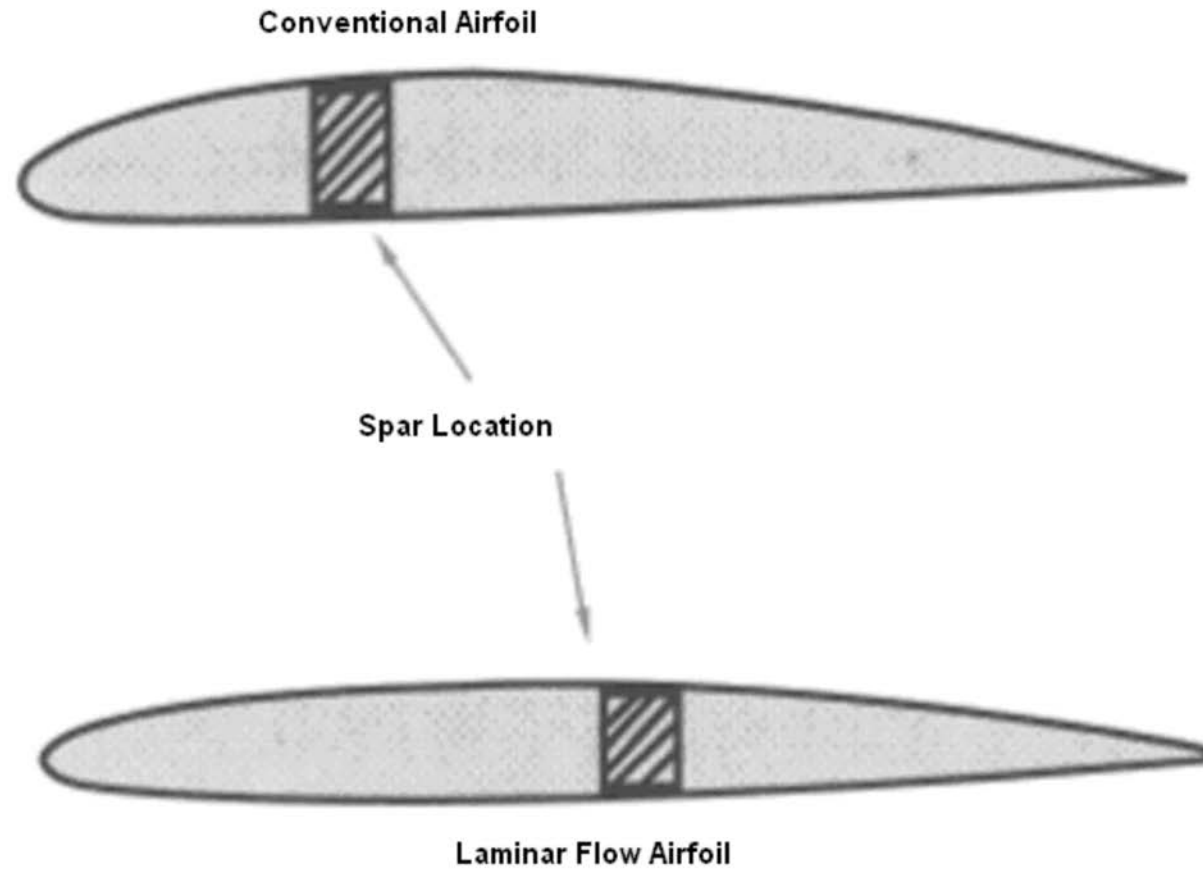

Figure A-3 Conventional and Laminar Flow Airfoils

Note. From *From the Ground Up: Millennium Edition* (p. 27), by A. F. MacDonald and I. L. Pepler, 2000, Ottawa, ON: Aviation Publishers Co. Limited. Copyright 2000 by Aviation Publishers Co. Limited.

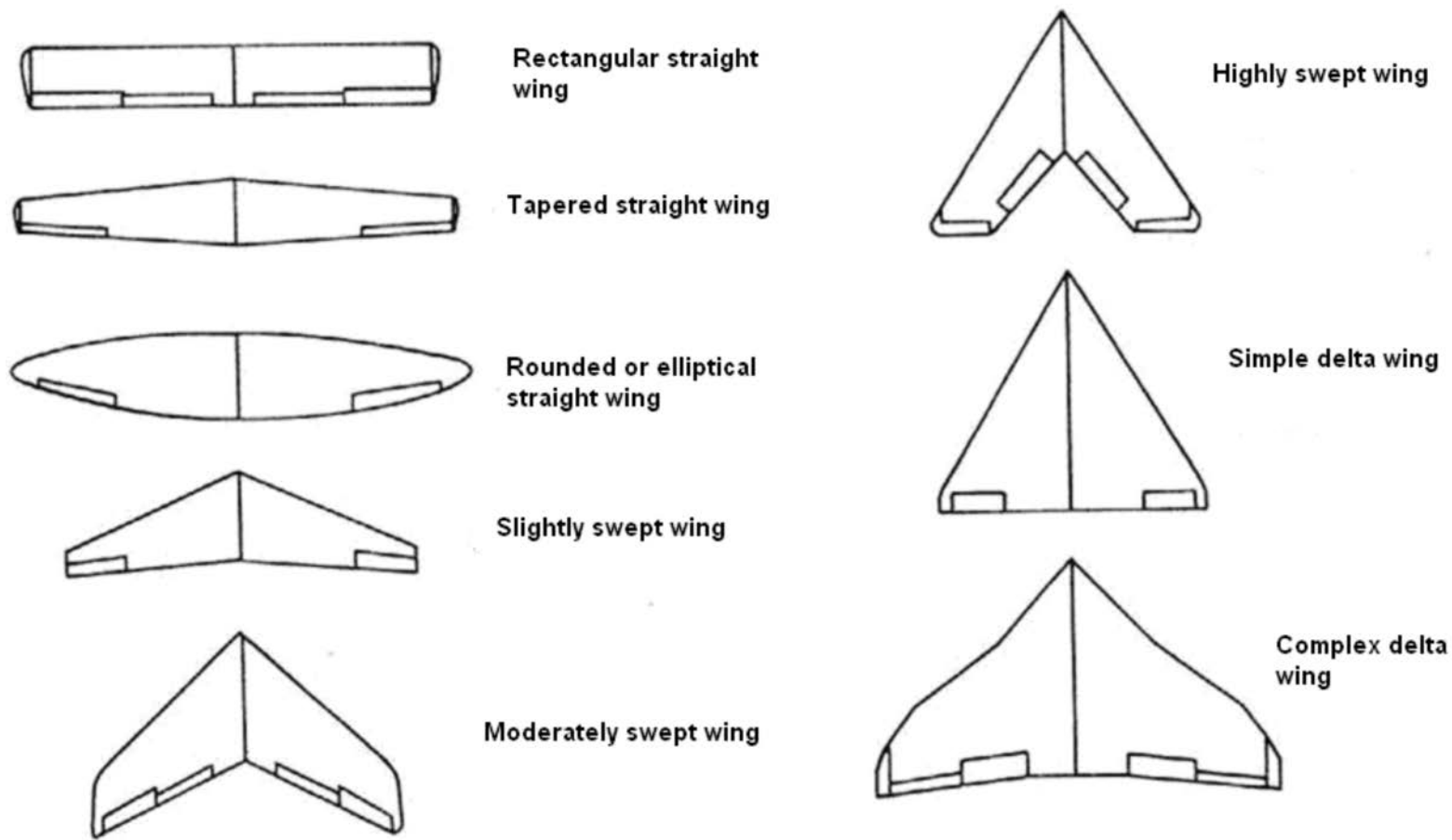

Figure A-4 Examples of Wing Planforms

Note. From "SP-367 Introduction to the Aerodynamics of Flight", NASA. Retrieved October 22, 2008, from <http://history.nasa.gov/SP-367/f13b.htm>

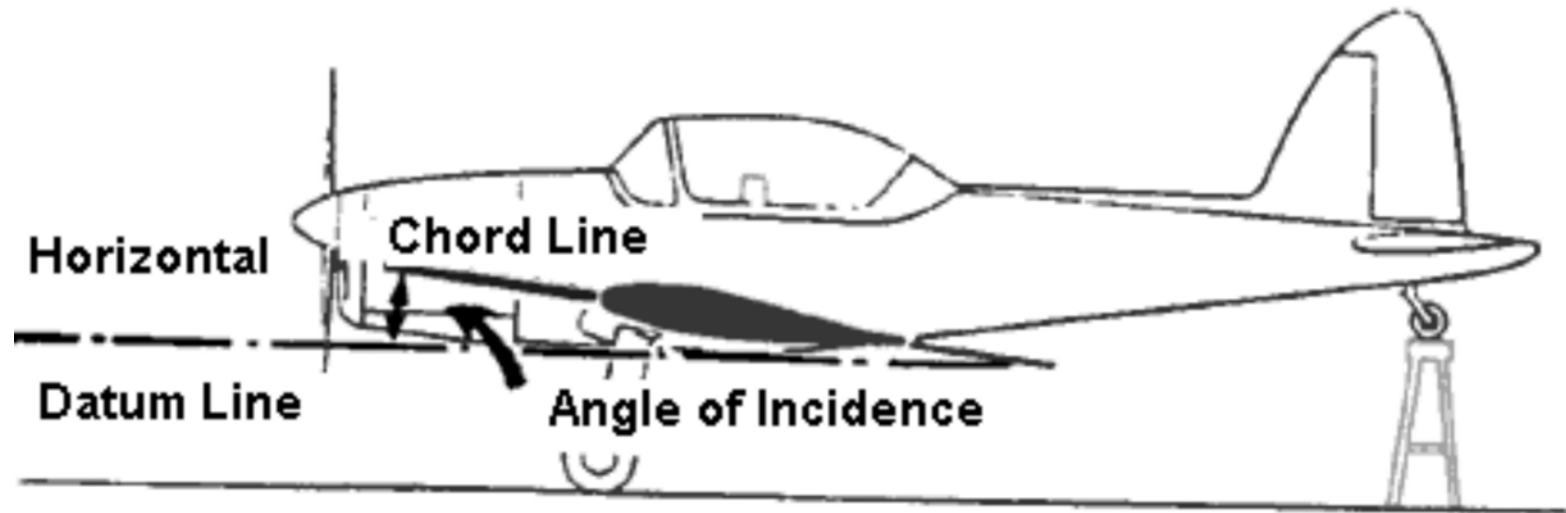

Figure A-5 Angle of Incidence

Note. From *From the Ground Up: Millennium Edition* (p. 27), by A. F. MacDonald and I. L. Pepler, 2000, Ottawa, ON: Aviation Publishers Co. Limited. Copyright 2000 by Aviation Publishers Co. Limited.

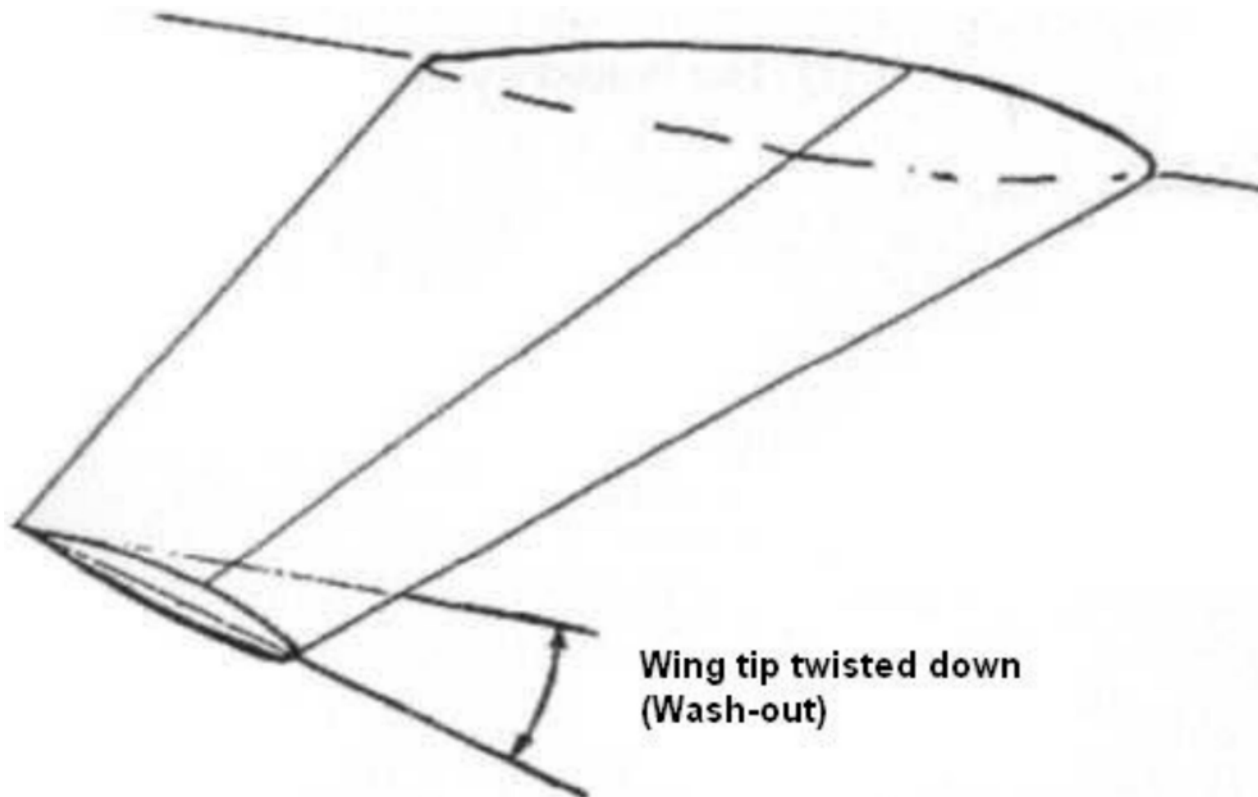

Figure A-6 Wash-Out

Note. From "Wing Twist and Dihedral", 2001, *Aerospaceweb.org*. Retrieved October 22, 2008, from <http://www.aerospaceweb.org/question/dynamics/q0055.shtml>



Figure A-7 Wing Tip Tanks and Winglets

Note. From "Canada's Air Force, Image Gallery, Details", 2006, *Department of National Defence*, Copyright 2006 by Department of National Defence. Retrieved October 22, 2008, from http://www.airforceimagery.forces.gc.ca/netpub/server.np?find&catalog=casimages&template=detail2_e.np&field=itemid&op=matches&value=4461&site=casimages



Figure A-8 Drooping the Wing Tips

Note. From "Cessna 170", 2008, *Barnstormers.com*. Retrieved October 22, 2008, from http://www.barnstormers.com/listing_images.php?id=266438&ZOOM=%2Fclassified_files%2F266438-DSC04234.jpg



Figure A-9 Wing Fences

Note. From "STOL Kit", *F. and H. (Aircraft)*. Retrieved October 22, 2008, from http://www.fandh-aircraft.co.uk/stol_kit.htm

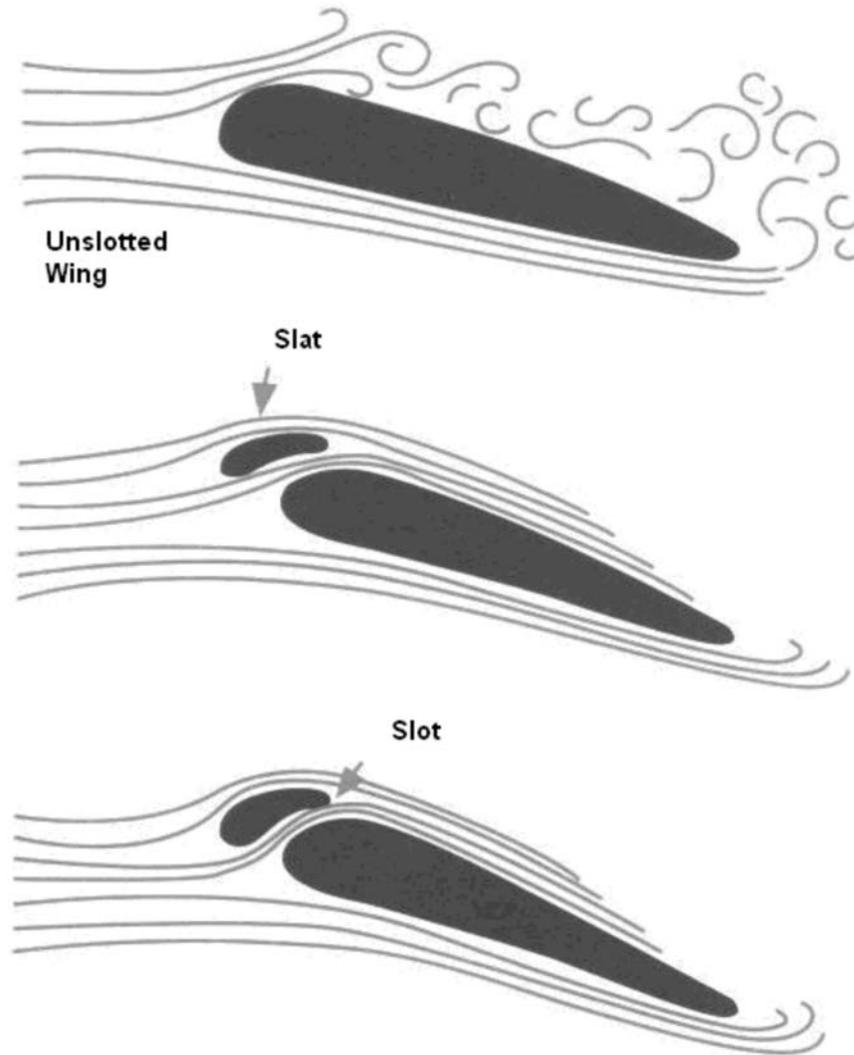

Figure A-10 Slotted Wings

Note. From *From the Ground Up: Millennium Edition* (p. 28), by A. F. MacDonald and I. L. Pepler, 2000, Ottawa, ON: Aviation Publishers Co. Limited. Copyright 2000 by Aviation Publishers Co. Limited.



Figure A-11 Leading Edge Slot

Note. From "Stinson 108", 2005, *Wikipedia*. Retrieved October 22, 2008, from <http://en.wikipedia.org/wiki/Image:Stinson108-3photo03.jpg>

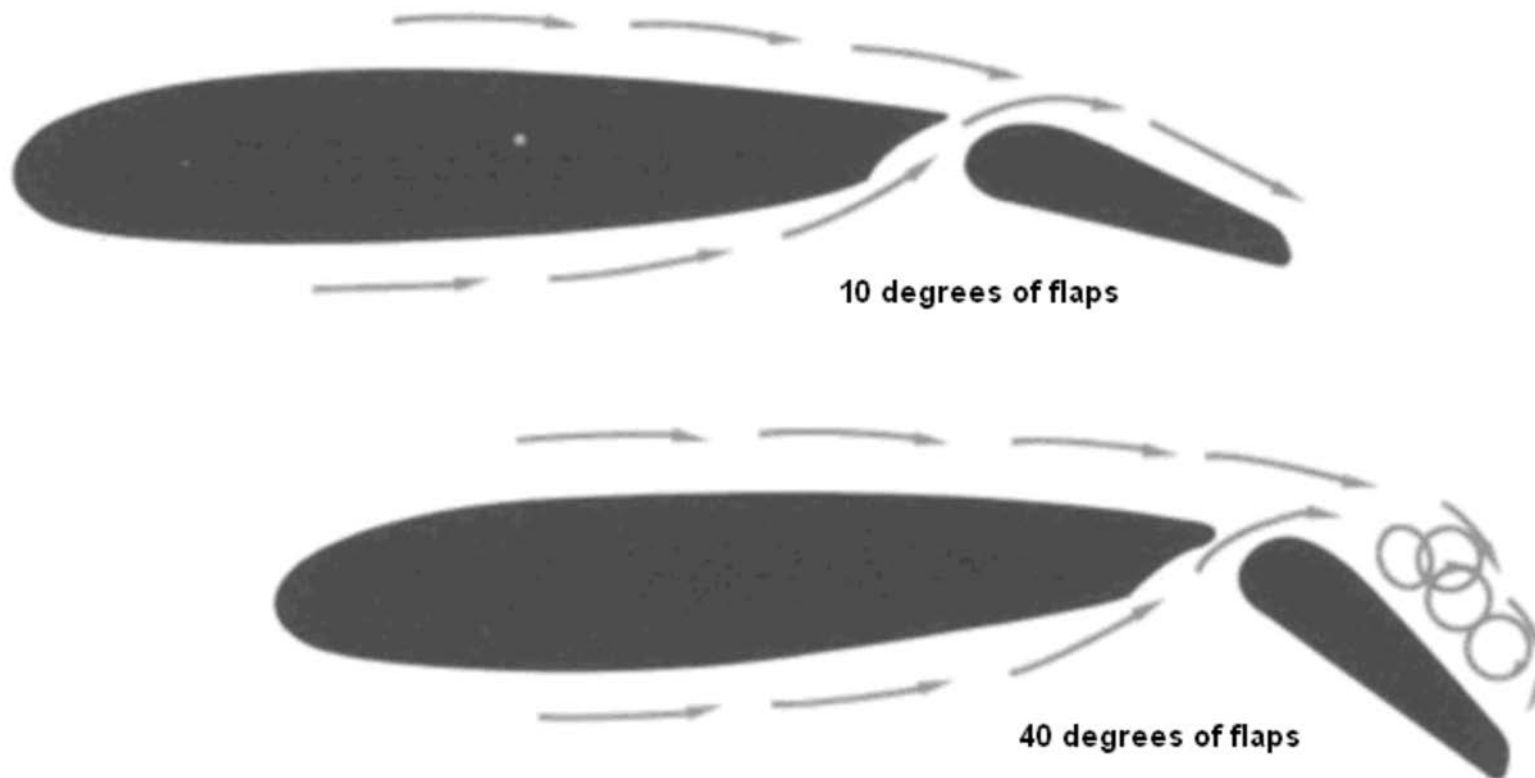

Figure A-12 Flap Settings

Note. From *From the Ground Up: Millennium Edition* (p. 29), by A. F. MacDonald and I. L. Pepler, 2000, Ottawa, ON: Aviation Publishers Co. Limited. Copyright 2000 by Aviation Publishers Co. Limited.

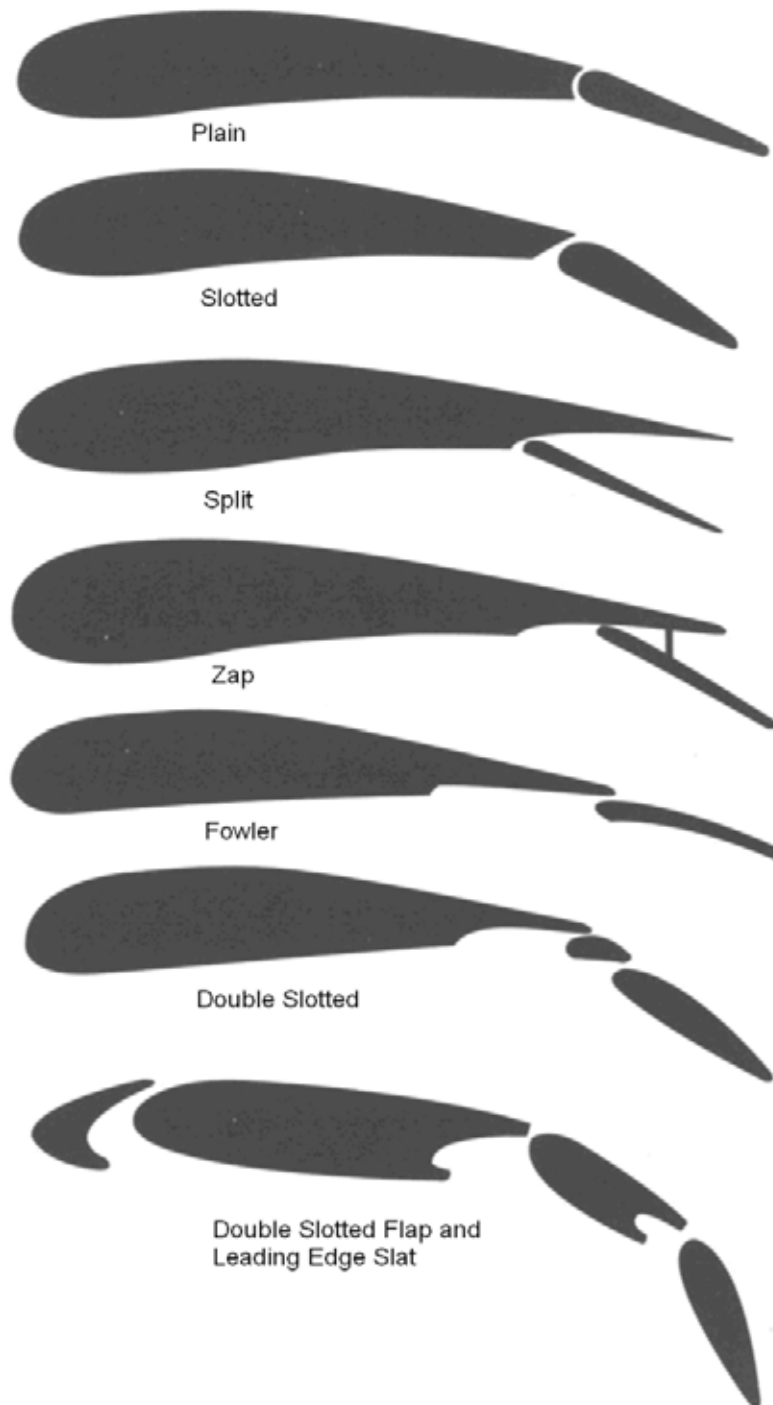

Figure A-13 Flaps

Note. From *From the Ground Up: Millennium Edition* (p. 29), by A. F. MacDonald and I. L. Pepler, 2000, Ottawa, ON: Aviation Publishers Co. Limited. Copyright 2000 by Aviation Publishers Co. Limited.

Spoilers and Dive Brakes Closed



Spoilers and Dive Brakes Open

Figure A-14 Spoilers and Dive Brakes

Note. From *Air Cadet Gliding Program Manual* (p. 6-3-2), 2008, Ottawa, ON: Department of National Defence.



**ROYAL CANADIAN AIR CADETS
PROFICIENCY LEVEL FOUR
INSTRUCTIONAL GUIDE**



SECTION 2

EO M431.02 – DESCRIBE FLIGHT INSTRUMENTS

Total Time:	60 min
-------------	--------

PREPARATION

PRE-LESSON INSTRUCTIONS

Resources needed for the delivery of this lesson are listed in the lesson specification located in A-CR-CCP-804/PG-001, *Proficiency Level Four Qualification Standard and Plan*, Chapter 4. Specific uses for said resources are identified throughout the instructional guide within the TP for which they are required.

Review the lesson content and become familiar with the material prior to delivering the lesson.

Photocopy Attachment A for each cadet.

Prepare slides of the figures located at Attachment A.

Obtain a gyroscope for use in TP2.

Construct a working model of each of the pitot static instruments IAW Attachment C.

PRE-LESSON ASSIGNMENT

Nil.

APPROACH

An interactive lecture was chosen for this lesson to clarify, emphasize and summarize flight instruments.

INTRODUCTION

REVIEW

Nil.

OBJECTIVES

By the end of this lesson the cadet shall be expected to describe flight instruments.

IMPORTANCE

It is important for cadets to be able to describe flight instruments as they are the basic instruments used during flight. Being able to describe flight instruments provides knowledge for potential instructional duties and is part of the fundamentals that cadets pursuing future aviation training will require.

Teaching Point 1**Review the pitot static system and pitot static instruments.**

Time: 25 min

Method: Interactive Lecture

PITOT STATIC SYSTEM

Instruments connected to the pitot static system work on air pressure. There are two types of air pressure in the pitot static system:

- pitot pressure, and
- static pressure.

Pitot pressure. The increase in air pressure caused by the forward motion of the aircraft through the air.

Static pressure. The atmospheric pressure outside the aircraft, not affected by turbulence or motion.



Show the slide of Figure A-1 to the cadets.

The airspeed indicator (ASI) is connected to both the pitot pressure source (usually a tube attached to the nose or wing) and the static pressure port(s) (usually a small vent on the side of the aircraft). The altimeter and the vertical speed indicator (VSI) are connected only to the static pressure port.

Both the pitot tube and static pressure ports should be carefully checked during the walk-around inspection prior to flight to ensure they are not blocked. A blockage will cause an instrument to provide an incorrect reading. During flight, it is possible for the pitot tube to become blocked by ice. Aircraft that are designed to be flown under instrument flight rules (IFR) will have a pitot heater to prevent ice buildup in the pitot tube.

AIRSPEED INDICATOR (ASI)

The ASI is connected to both the pitot pressure source and static pressure port(s) and displays the difference between the two pressures as the speed of the aircraft moving through the air (not over the ground).

ASI Markings

The ASI has colour-coded markings to indicate operating ranges and speeds.



Show the slide of Figure A-2 to the cadets.

Red. A red line indicates the never exceed speed (V_{NE}).

Yellow. A yellow arc starts at the maximum structural cruise (V_{NO}) and extends to the V_{NE} . This area is typically known as the caution range.

Green. The normal operating range. It starts at the power-off stalling speed (V_{SL}) and extends to the V_{NO} .

White. The range in which fully extended flaps may be used. It starts at the power-off stalling speed with flaps and gear extended (V_{SO}) and extends to the maximum flaps extended speed (V_{FE}).

ASI Errors

Density error. The ASI is calibrated for normal sea level pressure of 29.92 inches of mercury (Hg) at a temperature of 15 degrees Celsius. Temperature and pressure normally decrease with an increase in altitude, decreasing the density of the air and causing the ASI to read less than the true airspeed.

Position error. Results from the position of the pitot pressure source. Eddies formed by air moving over the aircraft and the angle of the pitot source to the airflow cause position error.

Lag error. A mechanical error that is the result of friction between the working parts of the instrument. This error is responsible for a slight delay between a change in airspeed occurring and the change being shown on the instrument.

Icing error. The error caused by a complete or partial blockage of the pitot pressure by ice. This error can be prevented or corrected by turning on the pitot heat (if equipped) or descending to a lower altitude where the outside air temperature (OAT) is higher.

Water error. Water in the system can cause higher or lower than normal readings and may block the system completely. Water can be kept out of the system by covering the pitot source when the aircraft is parked. This will also keep dirt and insects from entering the system.

Airspeed Definitions

Indicated airspeed (IAS). The uncorrected airspeed read from the instrument dial.

Calibrated airspeed (CAS). The IAS corrected for instrument (lag) error and installation (position) error.

Equivalent airspeed (EAS). The CAS corrected for the compressibility factor. This is very significant to aircraft operating above 10 000 feet and 250 knots (kt).

True airspeed (TAS). The CAS (or EAS) corrected for density (pressure and temperature).

ALTIMETER

The altimeter is connected only to the static pressure port(s) and measures the pressure of the outside air. A sealed aneroid capsule inside the instrument case expands or contracts due to changes in the static pressure. The expansion or contraction is mechanically linked to the indicator's needles and causes them to rotate around the dial to show the altitude.



Show the slide of Figure A-3 to the cadets.

Altimeter Errors

Pressure error. Barometric pressure varies from place to place and this error is corrected by using an altimeter setting obtained from the nearest aviation facility (flight service station, control tower, etc). All aircraft flying in the same area should be using the same altimeter setting.



"From high to low—look out below".

When an aircraft flies into an area with a relatively lower pressure, if the altimeter setting is not corrected, the altimeter will read higher than the actual altitude. For example, the altimeter may be indicating 4 000 feet, while the actual altitude may be

3 000 feet. This could cause a conflict with other aircraft, or even worse, cause the aircraft to come into contact with the ground.

Abnormally high pressure. Cold, dry air masses are capable of producing barometric pressures in excess of 31.00 inches of Hg (the limit of the altimeter setting scale in most altimeters). In this case, the actual altitude will be higher than the altitude indicated on the altimeter.

Abnormally cold temperature. Altimeters are calibrated for the standard atmosphere (15 degrees Celsius at sea level) and any deviation from that will cause an error. Extremely low temperatures may cause as much as 20 percent error in the altimeter, causing the altimeter to read higher than the actual altitude.

Mountain effect error. Increased wind speed through mountain passes or in mountain waves may cause a localized area of low pressure. Temperatures may also be affected, compounding the altimeter error.

Altitude Definitions

Indicated altitude. The altitude displayed on the altimeter when it is set to the current barometric pressure.

Pressure altitude. The altitude displayed on the altimeter when it is set to the standard barometric pressure (29.92 inches of Hg).

Density altitude. The pressure altitude corrected for temperature.

Absolute altitude. The actual height above the Earth's surface (the altimeter set to field level pressure).

VERTICAL SPEED INDICATOR (VSI)

The VSI is connected only to the static pressure port(s). The rate of change of the static pressure is transmitted to the needle to indicate if the altitude is increasing or decreasing.



Show the slide of Figure A-4 to the cadets.

Even though the VSI will quickly indicate a climb or descent, it may take several seconds before the correct rate of descent is displayed. This delay is known as lag. An instantaneous VSI has a complicated system of pistons and cylinders instead of the simpler aneroid capsule found in most VSIs and does not experience lag.

ACTIVITY

Time: 10 min

OBJECTIVE

The objective of this activity is to have the cadets practice reading pitot static instruments.

RESOURCES

- One working model of each of the pitot static instruments, including:
 - ASI,
 - altimeter, and
 - VSI; and
- Questions located at Attachment B.

ACTIVITY LAYOUT

Nil.

ACTIVITY INSTRUCTIONS

1. Divide the cadets into two groups.
2. Set one model at a time (in no particular order) and allow each group five seconds to read the instrument.
3. Have one group read the instrument to the class. The group gets one point for a correct answer.
4. If a group cannot correctly read the instrument then the other group can steal the point.
5. Repeat Steps 2–4 for the remaining time.
6. Declare the group with the most points the winner.

SAFETY

Nil.

CONFIRMATION OF TEACHING POINT 1

The cadets' participation in the activity will serve as the confirmation of this TP.

Teaching Point 2

Describe the gyroscope and gyroscopic instruments.

Time: 15 min

Method: Interactive Lecture

THE GYROSCOPE

The gyroscope is a spinning wheel (rotor) in a universal mounting (gimbal) that allows its axle to be pointed in any direction.



Show the slide of Figure A-5 to the cadets.

Gyroscopic Inertia

Also known as rigidity in space, gyroscopic inertia is the tendency of a rotating object to remain in its plane of rotation. This allows the spinning rotor to remain in place regardless of how the gimbal is moved around it.

Precession

Precession is the tendency of a rotating body, when a force is applied perpendicular to its plane of rotation, to turn in the direction of its rotation 90 degrees to its axis and take up a new plane of rotation parallel to the force applied.



Demonstrate gyroscopic inertia and precession to the cadets using a gyroscope.

Power Sources

To work properly the rotor must be kept spinning at a constant speed. The gyroscopic instruments may be powered by one or more power source.

Engine driven vacuum system. A vacuum pump powered by the engine. It does not work if the engine is not running (eg, prior to startup, following an engine failure). A variation of this system is an engine driven air pump that uses positive air pressure to spin the rotor.

Venturi driven vacuum system. A venturi tube on the outside of the aircraft creates a vacuum to spin the rotor. Simple to install, it has no moving parts that could fail, but depends on the airspeed of the aircraft and the tube causes additional drag.

Electrically driven gyroscopes. The rotor is spun by an electric motor allowing the gyroscope to work at high altitudes where vacuum systems are ineffective.

Care of Gyroscopic Instruments

Gyroscopic instruments are precision instruments and need to be cared for properly to prevent premature failure and damage. The air used to spin the rotor (vacuum or positive pressure) must be filtered to prevent dust and dirt from contaminating the system. The instruments need to be handled gently during installation and removal. Some gyroscopes must also be locked (caged) prior to aerobatics. Venturi driven systems are also susceptible to ice blockages.

HEADING INDICATOR (HI)



Show the slide of Figure A-6 to the cadets.

The HI (directional gyro [DG]) is steady and accurate as it is not afflicted with any of the errors that apply to magnetic compasses (eg, northerly turning error, acceleration and deceleration errors). It remains constant without swinging or oscillating and provides accurate readings even in rough air.



The cadets will learn about the magnetic compass in more detail in EO M437.02 (Describe the Magnetic Compass).

Vacuum driven HIs may take up to five minutes for the rotor to reach operating speed and should not be used during this period. Venturi driven HIs can not be used while taxiing or during takeoff. Once the rotor is spinning at the correct speed, the HI needs to be set to the current heading (by referencing the magnetic compass or runway heading).

Friction in the gyroscope causes a small amount of precession and will cause the reading to drift approximately three degrees over a period of 15 minutes. It is also subject to apparent precession. The rotation of the Earth gives the gyroscope an apparent motion relative to the Earth. This error varies with latitude. Apparent precession is zero at the equator and 15 degrees per hour at the poles.

Precession errors are easily corrected by resetting the HI to the current heading (by referencing the magnetic compass during straight and level flight) every 15 minutes.

ATTITUDE INDICATOR (AI)



Show the slide of Figure A-7 to the cadets.

The AI (artificial horizon or gyro horizon) is designed to provide an artificial horizon for the pilot during periods of poor visibility (eg, fog, clouds, rain, snow). The artificial horizon provides attitude information to the pilot (pitch and bank).

During acceleration or deceleration, precession will cause a slight indication of a climb or descent, respectively.

TURN AND SLIP INDICATOR



Show the slide of Figure A-8 to the cadets.

The turn and slip indicator (turn and bank) is a combination of two instruments and is also known as the needle and ball. The direction and rate of turn is indicated by the needle. The needle is controlled by a gyroscope. The ball is controlled by gravity. During a properly executed turn, centripetal and centrifugal forces are balanced with gravity and the ball stays in the centre. During a slipping turn there is not enough centrifugal force and the gravity will pull the ball in the direction of the turn. During a skidding turn there is not enough centripetal force and the ball is pulled in the opposite direction of the turn.



The turn and slip indicator does not indicate the amount of bank of the aircraft. It indicates the rate of turn and if the aircraft is skidding or slipping in the turn.

During a standard rate (rate one) turn, the aircraft turns at a rate of three degrees per second (360 degrees in two minutes).

The turn and slip indicator will also indicate if a wing is low during straight flight. If the needle is centred but the ball is not, then the wing on the side that the ball has moved to is low.

TURN CO-ORDINATOR



Show the slide of Figure A-9 to the cadets.

The turn co-ordinator is an updated version of the turn and slip indicator and is able to display the rate of roll as well as the rate of turn.

CONFIRMATION OF TEACHING POINT 2

QUESTIONS:

- Q1. What is gyroscopic inertia?
- Q2. What errors affect the HI?
- Q3. Which gyroscopic instrument can display the rate of roll as well as the rate of turn?

ANTICIPATED ANSWERS:

- A1. Gyroscopic inertia is the tendency of a rotating object to remain in its plane of rotation.
- A2. Precession and apparent precession.
- A3. The turn co-ordinator.

Teaching Point 3

Describe the angle of attack (AOA) indicator.

Time: 5 min

Method: Interactive Lecture

ANGLE OF ATTACK (AOA) INDICATOR



Show the slide of Figure A-10 to the cadets.

An aircraft will stall at different airspeeds depending on factors such as weight, load factor, and configuration. A stall will occur if the critical angle of attack is exceeded. The AOA indicator displays the relationship between the chord line of the wing and the relative airflow. Many indicators also have colour-coded ranges to alert the pilot that the critical AOA is being approached.

CONFIRMATION OF TEACHING POINT 3

QUESTIONS:

- Q1. What does the AOA indicator display?

ANTICIPATED ANSWERS:

- A1. The AOA indicator displays the relationship between the chord line of the wing and the relative airflow.

Teaching Point 4**Describe the Mach indicator.**

Time: 5 min

Method: Interactive Lecture

MACH INDICATOR

Show the slide of Figure A-11 to the cadets.

The Mach indicator displays the ratio of its airspeed to the local speed of sound. The Mach number is calculated by dividing the airspeed by the speed of sound. A Mach number of one means that the aircraft is travelling at the speed of sound. The Mach indicator measures and correlates static and dynamic pressures.



Distribute the handouts of flight instruments located at Attachment A to each cadet.

CONFIRMATION OF TEACHING POINT 4**QUESTIONS:**

Q1. How is the Mach number calculated?

ANTICIPATED ANSWERS:

A1. The Mach number is calculated by dividing the airspeed by the speed of sound.

END OF LESSON CONFIRMATION**QUESTIONS:**

Q1. What is density altitude?

Q2. How long does it take to complete a standard rate 360-degree turn?

Q3. How does the Mach indicator work?

ANTICIPATED ANSWERS:

A1. The pressure altitude corrected for temperature.

A2. Two minutes.

A3. The Mach indicator works by measuring and correlating static and dynamic pressures.

CONCLUSION

HOMEWORK / READING / PRACTICE

Nil.

METHOD OF EVALUATION

This EO will be assessed IAW A-CR-CCP-804/PG-001, *Proficiency Level Four Qualification Standard and Plan*, Chapter 3, Annex B, Aviation Subjects–Combined Assessment PC.

CLOSING STATEMENT

Future aviation training and instructional duties require knowledge of pitot static instruments, gyroscopes and gyroscopic instruments.

INSTRUCTOR NOTES / REMARKS

Cadets who are qualified Advanced Aviation may assist with this instruction.

REFERENCES

C3-116 ISBN 0-9680390-5-7 MacDonald, A. F., & Pepler, I. L. (2000). *From the ground up: Millennium edition*. Ottawa, ON: Aviation Publishers Co. Limited.

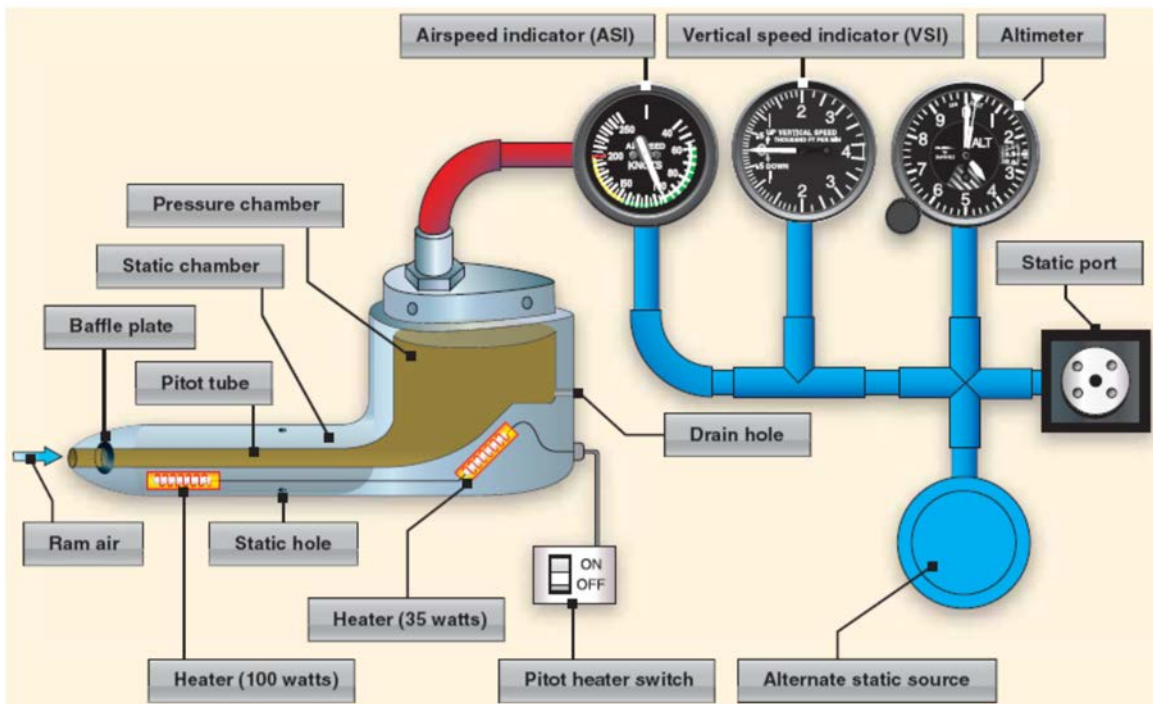

Figure A-1 Pitot Static System

Note. From "Pilot's Handbook of Aeronautical Knowledge", *Federal Aviation Administration*. Retrieved November 19, 2008, from <http://www.faa.gov/library/manuals/aviation/media/FAA-H-8083-25A.pdf>



Figure A-2 Airspeed Indicator

Note. From "Flight Instruments", *North American Powered Parachute Federation*. Retrieved October 30, 2007, from http://www.nappf.com/nappf_flight_instruments.htm



Figure A-3 Altimeter

Note. From "Flight Instruments", *North American Powered Parachute Federation*.
Retrieved October 30, 2007, from http://www.nappf.com/nappf_flight_instruments.htm



Figure A-4 Vertical Speed Indicator

Note. From "Flight Instruments", *North American Powered Parachute Federation*.
Retrieved October 30, 2007, from http://www.nappf.com/nappf_flight_instruments.htm

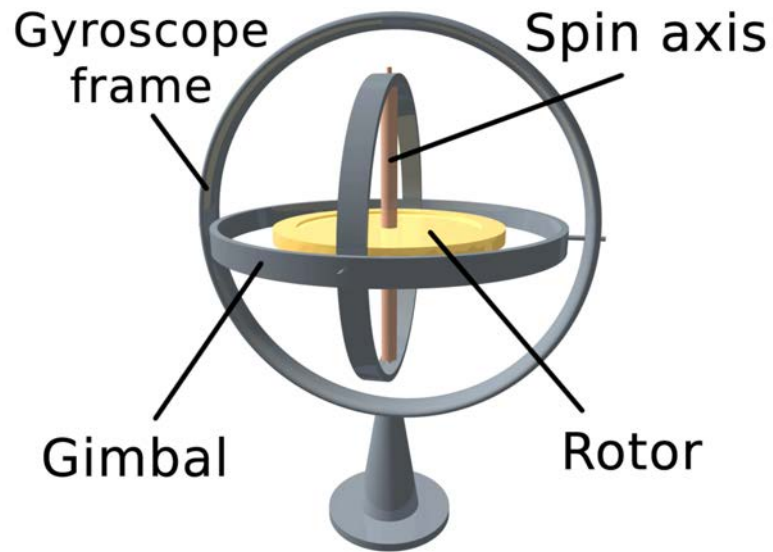

Figure A-5 Gyroscope

Note. From "3D Gyroscope", *Wikimedia*. Retrieved November 18, 2008, from http://upload.wikimedia.org/wikipedia/commons/e/e2/3D_Gyroscope.png

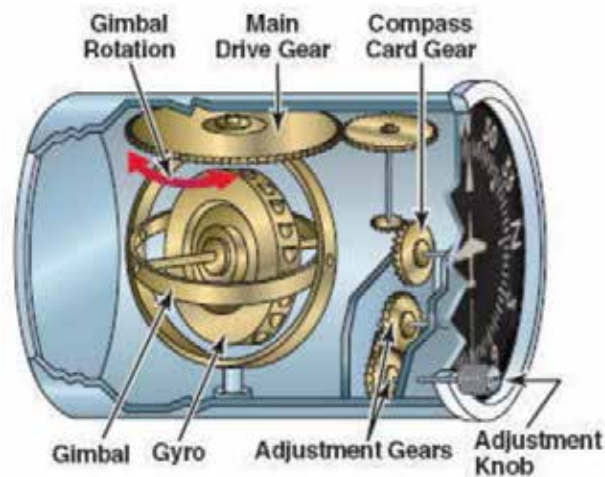

Figure A-6 Heading Indicator

Note. From "The Journal for the Proficient Pilot", *Over the Airwaves*. Retrieved November 18, 2008, from <http://overtheairwaves.com/vol3-46.jpg>

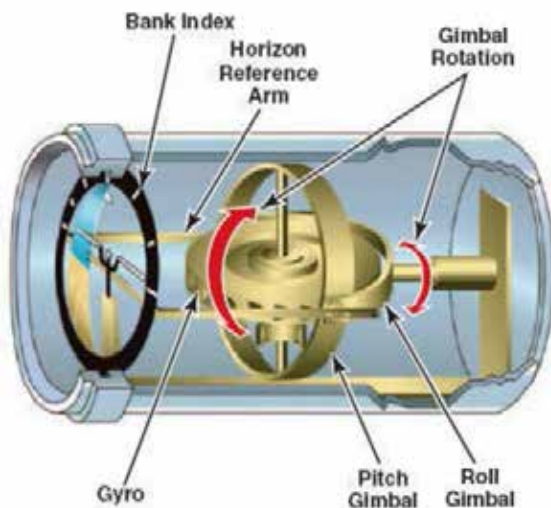

Figure A-7 Attitude Indicator

Note. From "The Journal for the Proficient Pilot", *Over the Airwaves*.
Retrieved November 18, 2008, from <http://overtheairwaves.com/vol3-45.jpg>



Figure A-8 Turn and Bank Indicator

Note. From "Turn and Bank Indicator", *Integrated Publishing*. Retrieved November 18, 2008, from http://www.tpub.com/content/aviation/14014/img/14014_164_2.jpg



Figure A-9 Turn Co-ordinator

Note. From "More Instruments", *Wings and Wheels*. Retrieved November 18, 2008, from <http://www.wingsandwheels.com/images/turn%20coordinator.gif>



Figure A-10 AOA Indicator

Note. From "Stall/Spin", *AOPA Online*. Retrieved November 18, 2008, from http://www.aopa.org/images/asf/tn_spin_9.jpg



Figure A-11 Mach Indicator

Note. From "Mach Airspeed Indicator (MASI)", *Innovative Solutions and Support*. Retrieved November 18, 2008, <http://www.innovative-ss.com/media/images/masi2.gif>

THIS PAGE INTENTIONALLY LEFT BLANK

SAMPLE QUESTIONS

Set the specific training aid to the desired reading. Allow a team to provide an answer. Use a different instrument for each question.

ASI Questions

For each question, set the ASI training aid to the desired value. These can be asked in any order.

125 kt
65 kt
40 kt
75 kt
180 kt
210 kt
98 kt
110 kt
55 kt

Altimeter Questions

For each question, set the altimeter training aid to the desired value. These can be asked in any order.

8 900 feet
1 300 feet
2 600 feet
11 000 feet
1 250 feet
600 feet
400 feet
300 feet
1 000 feet

VSI Questions

For each question, set the VSI training aid to the desired value. These can be asked in any order.

+200 feet per minute
+300 feet per minute
+150 feet per minute
+500 feet per minute
+800 feet per minute
-1000 feet per minute
-250 feet per minute
-900 feet per minute
-1200 feet per minute

THIS PAGE INTENTIONALLY LEFT BLANK

INSTRUCTIONS FOR CREATION OF PITOT STATIC INSTRUCTIONAL AIDS

Resources

- One sheet of bristol board per training aid,
- One brass Acco fastener per training aid,
- Pencil,
- Compass from a geometry set,
- Ruler or straight edge,
- Coloured markers, and
- White bristol board.

Instructions – ASI

1. Draw a representation of an ASI in the centre of the bristol board. Include all of the numbers and coloured arcs / lines. Use Figure A-2 as a guide.
2. Colour the arcs and lines with the appropriate colours (white arc, green arc, yellow arc and red line).
3. Cut out a dial hand from the white bristol board.
4. Attach the dial hand to the centre of the ASI using the brass Acco fastener.
5. Ensure that the hand can move when needed, but that there is enough friction to keep it from moving on its own.

Instructions – Altimeter

1. Draw a representation of an altimeter's face in the centre of the bristol board. Include all of the numbers and graduated lines between the numbers. Use Figure A-3 as a guide.
2. Colour the altimeter. To add variety of colour, use yellow and black for the polygon shape under the hands' pivot point.
3. Cut dial hands from the white bristol board to represent the hands of an altimeter.
4. Attach the hands to the centre of the altimeter using the brass Acco fastener.
5. Ensure that the hands can move when needed, but that there is enough friction to keep them from moving on their own.

Instructions – VSI

1. Draw a representation of a VSI in the centre of the bristol board. Include all of the numbers on the positive and negative scales. Ensure that zero is located on the left side. Use Figure A-4 as a guide.
2. Colour the VSI.
3. Cut out a dial hand from the white bristol board.
4. Attach the hand to the centre of the VSI using the brass Acco fastener.
5. Ensure that the hand can move when needed, but that there is enough friction to keep it from moving on its own.

THIS PAGE INTENTIONALLY LEFT BLANK



**ROYAL CANADIAN AIR CADETS
PROFICIENCY LEVEL FOUR
INSTRUCTIONAL GUIDE**



SECTION 3

EO C431.01 – EXPLAIN FLIGHT PERFORMANCE FACTORS

Total Time:	60 min
-------------	--------

PREPARATION

PRE-LESSON INSTRUCTIONS

Resources needed for the delivery of this lesson are listed in the lesson specification located in A-CR-CCP-804/PG-001, *Proficiency Level Four Qualification Standard and Plan*, Chapter 4. Specific uses for said resources are identified throughout the instructional guide within the TP for which they are required.

Review the lesson content and become familiar with the material prior to delivering the lesson.

Prepare handouts for each cadet and slides of the figures located at Attachment A.

Obtain a model aircraft with articulated control surfaces and flaps for use in TPs 1–5.

PRE-LESSON ASSIGNMENT

Nil.

APPROACH

An interactive lecture was chosen for this lesson to clarify, emphasize and summarize flight performance factors.

INTRODUCTION

REVIEW

Nil.

OBJECTIVES

By the end of this lesson the cadet shall be expected to explain flight performance factors.

IMPORTANCE

It is important for cadets to be able to explain flight performance factors as they apply to all stages of flight. Being able to explain flight performance factors provides knowledge for potential instructional duties and is part of the fundamentals that cadets pursuing future aviation training will require.

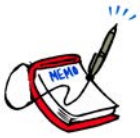

Use the model aircraft with articulated control surfaces and flaps throughout this lesson to illustrate flight performance factors as they are discussed.



Provide a handout of the figures to each cadet located at Attachment A.

Teaching Point 1

Explain left turning tendencies.

Time: 15 min

Method: Interactive Lecture

LEFT TURNING TENDENCIES

Most airplane engines turn the propeller in a clockwise direction (as seen from the pilot's seat). As a result of four different factors, this produces a tendency for the airplane to turn left. These tendencies must be factored into the design of the airplane or corrected by the pilot.

Torque

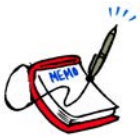

Show the slide of Figure A-1 to the cadets.

Newton's Third Law of Motion states that every action has an equal and opposite reaction. This means that the clockwise rotation of the propeller is counteracted by a counter-clockwise rotation of the airplane. This reaction tends to force the left wing downwards, producing a tendency to turn left.

To correct this, airplanes can be designed with a right turning tendency, typically by having a slightly greater angle of incidence on the left wing. During takeoff (when the engine is usually running at full power) additional corrections must be applied by the pilot (rudder and / or ailerons) because of the increased amount of torque.

Asymmetric Thrust



Show the slide of Figure A-2 to the cadets.

At high angles of attack and high power settings (eg, takeoff) the blade of the propeller that is travelling down (the blade on the right) has a greater angle of attack than the blade that is travelling up. This creates more thrust from the right side of the propeller and creates a tendency for the aircraft to yaw or turn left.

To correct for asymmetric thrust (also known as P Factor), the pilot uses right rudder.

Precession



Show the slide of Figure A-3 to the cadets.

The spinning propeller acts like a gyroscope and tends to stay in the same plane of rotation, and resists any change to the plane. When a perpendicular force is applied to change the plane, a resultant force called precession is the result.

The force of precession is ahead of the plane of rotation and 90 degrees to the original applied force. Precession occurs in airplanes when the tail is lifted or lowered (eg, takeoff in a tailwheel aircraft).

To correct for precession, the pilot uses right rudder.

Slipstream



Show the slide of Figure A-4 to the cadets.

The air being pushed backwards by the propeller has a corkscrew motion and is called the slipstream. This causes more pressure on the left side of the fuselage and tail, and results in a tendency for the airplane to turn left.

The effects of the slipstream can be corrected by having the engine thrust line offset to the right, and / or by offsetting the vertical fin. When the airspeed of the airplane is low (eg, takeoff) the pilot may have to apply right rudder.

CONFIRMATION OF TEACHING POINT 1

QUESTIONS:

- Q1. What four factors contribute to an airplane's left turning tendency?
- Q2. Which propeller blade has a greater angle of attack at high angles of attack?
- Q3. Which factor produces more pressure on the left side of the fuselage and tail?

ANTICIPATED ANSWERS:

- A1. Torque, asymmetric thrust, precession, and slipstream.
- A2. The blade moving downwards.
- A3. Slipstream.

Teaching Point 2**Explain climbs and glides.**

Time: 10 min

Method: Interactive Lecture

CLIMBS

During level flight at a constant airspeed, the engine produces thrust equal to drag, and the wings produce lift equal to weight. A pilot can initiate a climb by increasing the angle of attack (eg, pulling back on the stick) to produce more lift. The aircraft will climb but the airspeed will decrease.



Show the slide of Figure A-5 to the cadets.

The pilot could also initiate a climb by increasing the power setting of the engine (which would cause an increase in airspeed). If the angle of attack is not changed, the increased airspeed will create additional lift and the airplane will climb.

Once the climb is established, the aircraft is again in equilibrium. The attitude of the aircraft creates a rearward component of weight. In this state, thrust must equal drag plus the rearward component of weight and lift must equal weight, less its rearward component.

The extra power available from the engine to overcome the rearward component of weight determines the aircraft's ability to climb. As the altitude of the airplane increases, the air becomes less dense, and the available power of the engine decreases. The climb angle is reduced and further climbing eventually becomes impossible. The altitude at which this occurs is the absolute ceiling of the airplane.

Best rate of climb (V_Y). The rate of climb that gains the most altitude in the least amount of time. It is normally used during takeoff after all obstacles have been cleared.

Best angle of climb (V_X). The angle of climb that gains the most altitude in a given distance. It is used during takeoff to clear obstacles at the departure end of the runway.

Normal climb (cruise climb). The rate of climb recommended for prolonged climbs. It provides better cooling, visibility, and control compared to V_Y .

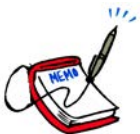
GLIDES

Show the slide of Figure A-6 to the cadets.

During a glide, the engine is producing minimal power and the airplane is influenced by gravity. In this state, equilibrium is achieved by balancing lift, weight, and drag.

To increase airspeed, the angle of the glide must be increased. Reducing airspeed creates a shallower glide, until the point of a stall.

A windmilling propeller (the propeller is being spun by the relative wind, not the power of the engine) can reduce the gliding distance by approximately 20 percent. Although getting the propeller to stop can increase the gliding

range, it is difficult to perform. Additionally, the chances of restarting the engine are improved if the propeller is windmilling.

Best glide speed for range (maximum lift / drag). The airspeed which allows the aircraft to glide the farthest distance for altitude lost.

Best glide speed for endurance (minimum sink). The airspeed which allows the aircraft to remain in the air for the longest period of time.



Most airplane pilots are only concerned with the best glide speed for range airspeed as it is the airspeed usually used after an engine failure.

Sailplane (glider) pilots are concerned with both airspeeds. They use the minimum sink speed to remain in an area of rising air for as long as possible to extend the time of the flight.

CONFIRMATION OF TEACHING POINT 2

QUESTIONS:

- Q1. What is V_Y ?
- Q2. What is V_X ?
- Q3. What three forces must be balanced during a glide to achieve equilibrium?

ANTICIPATED ANSWERS:

- A1. Best rate of climb.
- A2. Best angle of climb.
- A3. Lift, weight, and drag.

Teaching Point 3

Explain turns.

Time: 5 min

Method: Interactive Lecture

TURNS



Show the slide of Figure A-7 to the cadets.

In straight and level flight, the lift created by the wings is acting perpendicular to the wing span (vertically). To turn the aircraft, the pilot uses the ailerons to bank the aircraft in the direction of the desired turn. The lift is acting perpendicular to the wing span, but has both a horizontal and vertical component. It is the horizontal component of the lift (known as the centripetal force) that makes the aircraft turn. The opposing force (known as the centrifugal force) pulls the aircraft to the outside of the turn.

To maintain a constant altitude, the vertical component of lift must remain equal to the weight of the aircraft. This can be accomplished by increasing the angle of attack or the airspeed (by adding power). If the angle of

attack is increased, additional power must be added to maintain the desired airspeed. The steeper the angle of bank, the more the angle of attack and power must be increased to maintain altitude.

At any given airspeed, a steeper angle of bank produces:

- a higher rate of turn,
- a lower radius of turn,
- a higher stalling speed, and
- a higher load factor (G load).

At any given angle of bank, a higher airspeed produces:

- a lower rate of turn, and
- a larger radius of turn.

Load Factors in Turns



Show the slide of Figure A-8 to the cadets.

Turns increase the load factor. The steeper the angle of bank, the higher the load factor is. For example, a 60-degree bank produces a load factor of two. This means an aircraft that weighs 2 500 kg will have an equivalent weight of 5 000 kg. Very steep turns can produce very high load factors and may lead to structural failure.

CONFIRMATION OF TEACHING POINT 3

QUESTIONS:

- Q1. Which component of lift makes the aircraft turn when it is banked?
- Q2. What is the name of the force that pulls the aircraft towards the outside of the turn?
- Q3. At any given airspeed, what does a steeper angle of bank produce?

ANTICIPATED ANSWERS:

- A1. The horizontal component (centripetal force).
- A2. The centrifugal force.
- A3. A steeper angle of bank produces:
- higher rate of turn,
 - lower radius of turn,
 - higher stalling speed, and
 - higher load factor (G load).

Teaching Point 4**Explain stalls, spins, and spirals.**

Time: 15 min

Method: Interactive Lecture

STALLS

Show the slide of Figure A-9 to the cadets.

At low angles of attack, the air flows smoothly over the wing. As the angle of attack increases, the separation point between the laminar area and the turbulent area moves forward. At the critical angle of attack (determined by the design of the airfoil) the laminar flow separates from the wing and a large loss of lift (called a stall) occurs.



An airplane will stall:

- if the critical angle of attack is exceeded,
- at any airspeed if the critical angle of attack is exceeded, and
- at any attitude if the critical angle of attack is exceeded.

Symptoms of a Stall

As a stall is approached, there is usually a light buffeting of the airframe and controls. Lateral control of the aircraft is reduced as the ailerons lose their effectiveness in the separated airflow. When the stall is reached, lift is lost and the nose of the airplane drops.

A stall occurs gradually on most airplanes, giving the pilot time to recognize and react to the symptoms. If there is wash-out designed in the wing, the wing root will stall first and the ailerons will still be effective in the early stages of the stall.

Factors Affecting Stalls

Weight. Increasing the weight of an airplane increases the indicated airspeed at which it will stall.

Centre of gravity. Moving the centre of gravity forward increases the indicated airspeed at which the airplane will stall. Moving the centre of gravity rearward decreases the indicated airspeed at which it will stall. Moving the centre of gravity beyond the design limits will affect handling, stability, stall characteristics, and stall recovery.

Turbulence. An upward gust increases the angle of attack of the wing and could cause the airplane to exceed the critical angle at a lower airspeed than would be expected in calm air.



Show the slide of Figure A-10 to the cadets.

Turns. As the angle of bank in a turn is increased, the load factor and stalling speed increase. The stall speed in a turn can be calculated by multiplying the normal stall speed by the square root of the load factor.

Flaps. Increase the lift produced by the wing and lower the indicated airspeed at which the airplane will stall.

Snow, frost and ice. Accumulations on the wing (including dirt and bugs) disrupt the airflow and add additional weight (especially accumulations of ice) causing an increase in the airspeed at which the airplane will stall and a lower critical angle of attack.

Heavy rain. Increases the airspeed at which an airplane will stall as the water forms a film over the surface of the wing. Raindrops create craters and waves in the film, reducing lift and increasing drag, much like frost does.

Stall Recovery

To recover from the stall, the wing has to produce sufficient lift. In general, the stall recovery for most light aircraft involves reducing the angle of attack (below the critical angle of attack). Applying power to increase the airspeed may also be part of the recovery process.

The pilot operating handbook (POH) for most light aircraft lists the following steps to recover from a stall:

1. Reduce the angle of attack by moving the control column forward.
2. Apply power to increase the airspeed.
3. Return to level flight.

SPINS



Show the slide of Figure A-11 to the cadets.

A spin may develop after a stall if one wing becomes disturbed and produces a different amount of lift. This may happen as a result of using ailerons, applying rudder to produce yaw, entering a stall in a banked attitude, or movement of a wing by turbulent air.

When one wing drops, it has a larger angle of attack and produces less lift (as it has already stalled) compared to the wing that is moving up which has a smaller angle of attack. This difference accelerates the rolling motion and autorotation sets in.



Show the slide of Figure A-12 to the cadets.

Stages of a Spin

A spin has three stages:

1. incipient,
2. developed, and
3. recovery.

The incipient stage occurs from the time the airplane stalls and rotation starts until the spin axis becomes vertical or nearly vertical.

In the developed stage, the angles and motions of the airplane are stabilized and the flight path is nearly vertical. During this stage the airspeed has stabilized.



A spin is a stalled condition with a constant airspeed during the developed stage.

Spin characteristics are different for different aircraft so the technique for recovery from the specific POH must be followed. In the absence of recommendations from the manufacturer, most light airplanes can be brought out of a spin by following these steps:

1. Decrease power to idle and neutralize ailerons.
2. Apply full rudder in the opposite direction of the rotation.
3. Move the control column forward to reduce the angle of attack and unstall the wings.
4. When rotation stops, neutralize the rudder, level the wings, and ease out of the dive.

SPIRALS

A spiral is a steep descending turn in which the aircraft rapidly loses altitude while the airspeed rapidly increases.

The characteristics of a spiral include:

- excessive angle of bank,
- rapidly increasing airspeed, and
- rapidly increasing rate of descent.

The recovery process for a spiral is as follows:

1. Decrease power to idle and level the wings simultaneously with coordinated use of rudder and ailerons.
2. Ease out of the dive.
3. Apply power as required to maintain altitude.



A spiral is not a stalled condition. An improper recovery can cause an excessive load factor and lead to structural failure.

CONFIRMATION OF TEACHING POINT 4

QUESTIONS:

- Q1. What must be exceeded in order for a stall to occur?
- Q2. What does the stall speed do as the angle of bank in a turn is increased?
- Q3. What is the difference between a spin and a spiral?

ANTICIPATED ANSWERS:

- A1. The critical angle of attack.
- A2. The stall speed increases.
- A3. A spin is a stalled condition and has a constant airspeed. A spiral is not a stalled condition and has a rapidly increasing airspeed.

Teaching Point 5

Explain airspeed limitations.

Time: 5 min

Method: Interactive Lecture

To reduce the risk of structural failure from an excessive load factor, airplane manufacturers publish a number of airspeed limitations in the POH.

Never exceed (maximum permissible dive) speed (V_{NE}). The maximum airspeed at which the airplane may be operated in smooth air.

Maximum structural cruise (normal operating limit) speed (V_{NO}). The maximum cruise airspeed at which the airplane was designed to operate.

Manoeuvring speed (V_A). The maximum airspeed at which the flight controls can be fully deflected without causing structural damage.

Maximum gust intensity speed (V_B). The maximum airspeed for penetration of gusts of maximum intensity. For most light airplanes V_A and V_B are the same.

Maximum flaps extended speed (V_{FE}). The maximum airspeed at which the airplane may be operated with the flaps extended.

CONFIRMATION OF TEACHING POINT 5

QUESTIONS:

- Q1. What does V_{NE} specify?
- Q2. What is the maximum airspeed at which the flight controls can be fully deflected?
- Q3. What does V_{FE} specify?

ANTICIPATED ANSWERS:

- A1. The maximum airspeed at which the airplane may be operated in smooth air.
- A2. V_A .
- A3. The maximum airspeed at which the airplane may be operated with the flaps extended.

END OF LESSON CONFIRMATION**QUESTIONS:**

- Q1. What happens to the load factor in a turn?
- Q2. What are the characteristics of a spiral?
- Q3. What is the maximum cruise airspeed at which the airplane was designed to operate?

ANTICIPATED ANSWERS:

- A1. The load factor increases.
- A2. The characteristics of a spiral include:
- excessive angle of bank,
 - rapidly increasing airspeed, and
 - rapidly increasing rate of descent.
- A3. V_{No} .

CONCLUSION

HOMEWORK / READING / PRACTICE

Nil.

METHOD OF EVALUATION

Nil.

CLOSING STATEMENT

Future aviation training and instructional duties depend on knowledge of left turning tendencies, climbs, glides, turns, stalls, spins, spirals and airspeed limitations.

INSTRUCTOR NOTES / REMARKS

Cadets who are qualified Advanced Aviation may assist with this instruction.

REFERENCES

C3-116 ISBN 0-9680390-5-7 MacDonald, A. F., & Peppler, I. L. (2000). *From the ground up: Millennium edition*. Ottawa, ON: Aviation Publishers Co. Limited.

THIS PAGE INTENTIONALLY LEFT BLANK

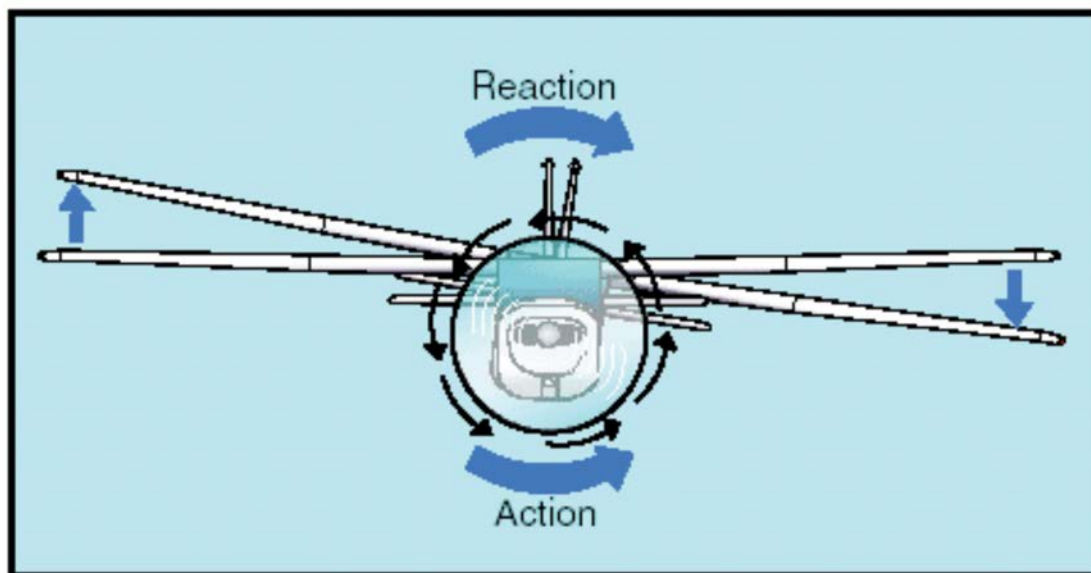

Figure A-1 Torque Reaction

Note. From "Propeller Aerodynamics", *Free Online Private Pilot Ground School*. Retrieved November 6, 2008, from <http://www.free-online-private-pilot-ground-school.com/propeller-aerodynamics.html>

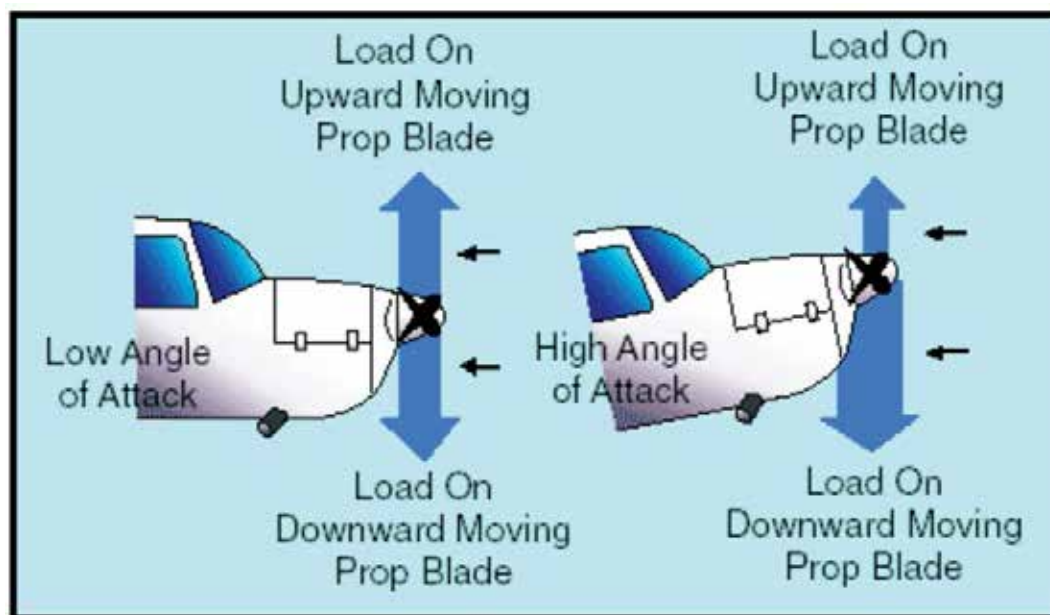

Figure A-2 Asymmetric Thrust (P Factor)

Note. From "Propeller Aerodynamics", *Free Online Private Pilot Ground School*. Retrieved November 6, 2008, from <http://www.free-online-private-pilot-ground-school.com/propeller-aerodynamics.html>

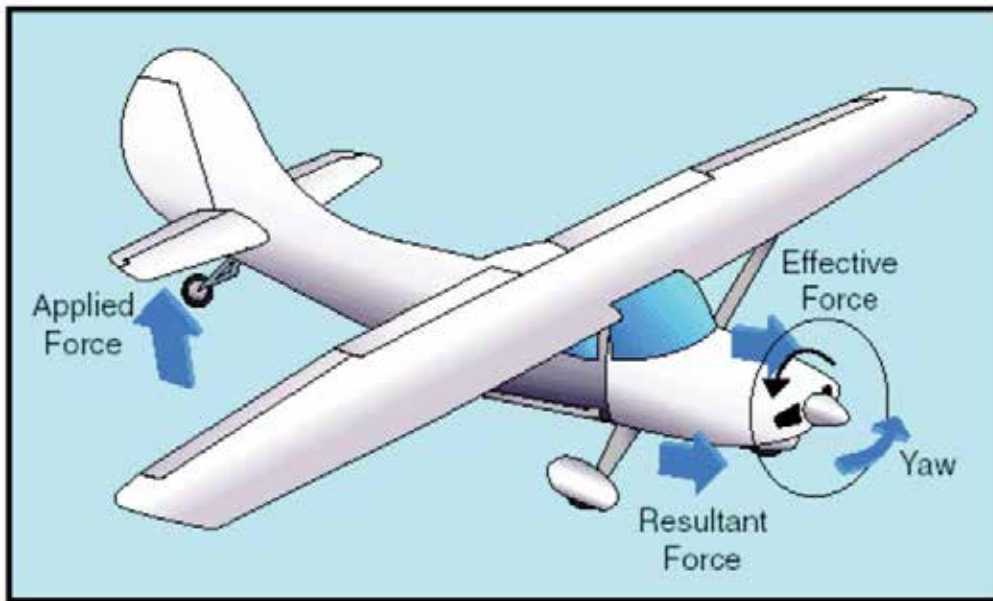

Figure A-3 Precession When the Tail is Lifted

Note. From "Propeller Aerodynamics", *Free Online Private Pilot Ground School*. Retrieved November 6, 2008, from <http://www.free-online-private-pilot-ground-school.com/propeller-aerodynamics.html>

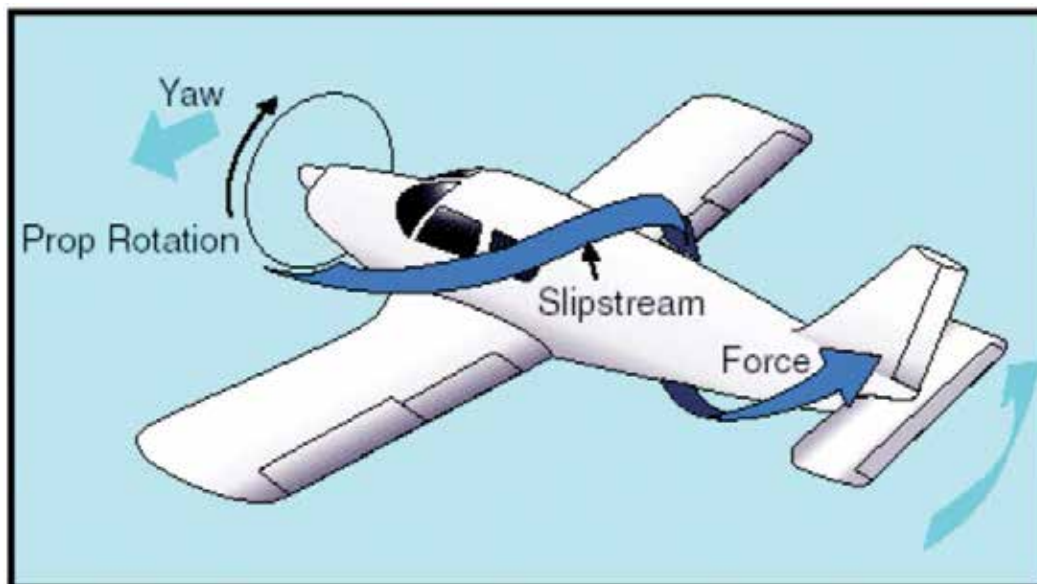

Figure A-4 Slipstream

Note. From "Propeller Aerodynamics", *Free Online Private Pilot Ground School*. Retrieved November 6, 2008, from <http://www.free-online-private-pilot-ground-school.com/propeller-aerodynamics.html>

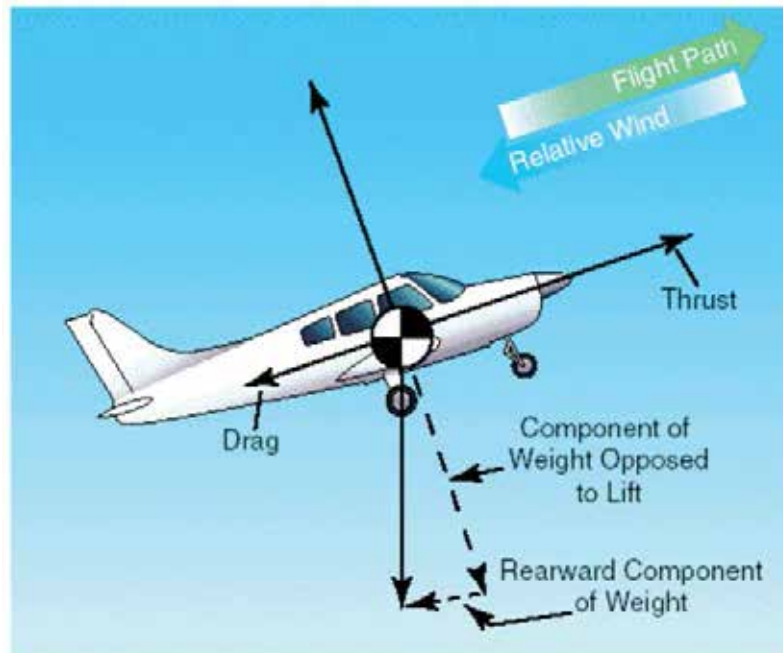

Figure A-5 Forces in a Climb

Note. From "Aerodynamics in Flight", *Free Online Private Pilot Ground School*. Retrieved November 6, 2008, from http://www.free-online-private-pilot-ground-school.com/Aerodynamics_in_flight.html

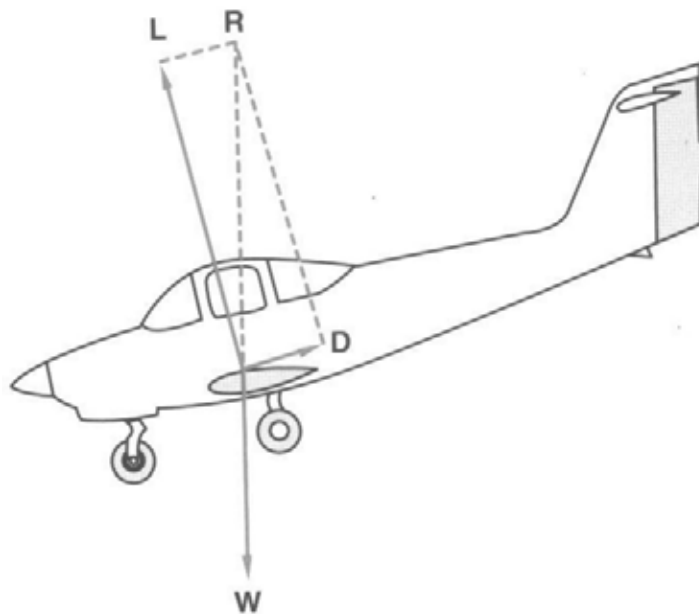

Figure A-6 Forces in a Glide

Note. From *From the Ground Up: Millennium Edition* (p. 34), by A. F. MacDonald and I. L. Pepler, 2000, Ottawa, ON: Aviation Publishers Co. Limited. Copyright 2000 by Aviation Publishers Co. Limited.

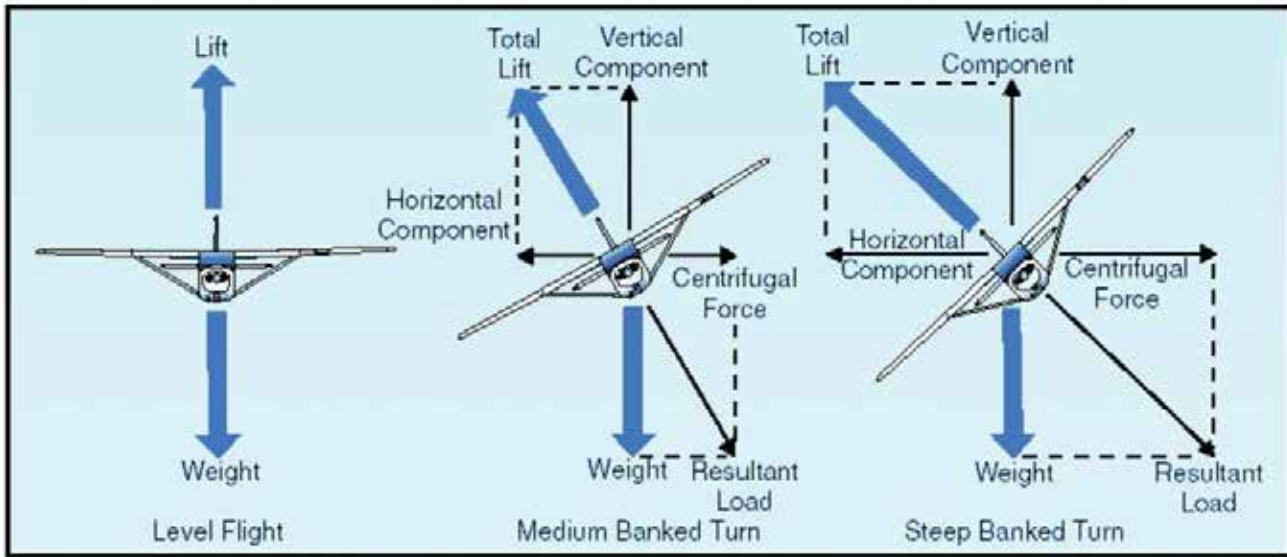

Figure A-7 Forces in a Turn

Note. From "Aerodynamics in Flight", *Free Online Private Pilot Ground School*. Retrieved November 6, 2008, from http://www.free-online-private-pilot-ground-school.com/Aerodynamics_in_flight.html

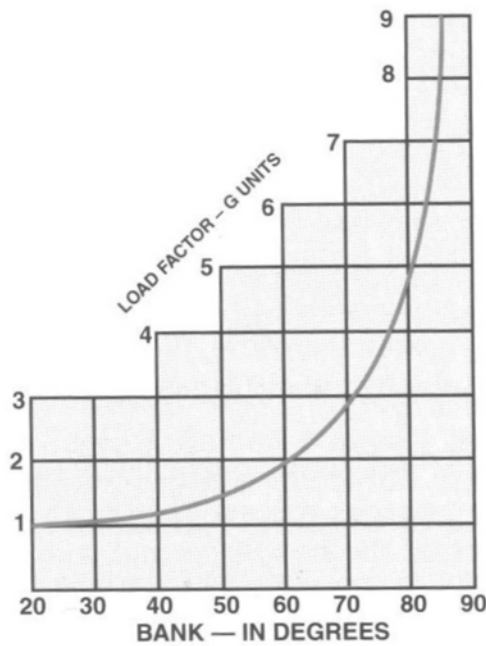

Figure A-8 Load Factors in Turns

Note. From *From the Ground Up: Millennium Edition* (p. 35), by A. F. MacDonald and I. L. Pepler, 2000, Ottawa, ON: Aviation Publishers Co. Limited. Copyright 2000 by Aviation Publishers Co. Limited.

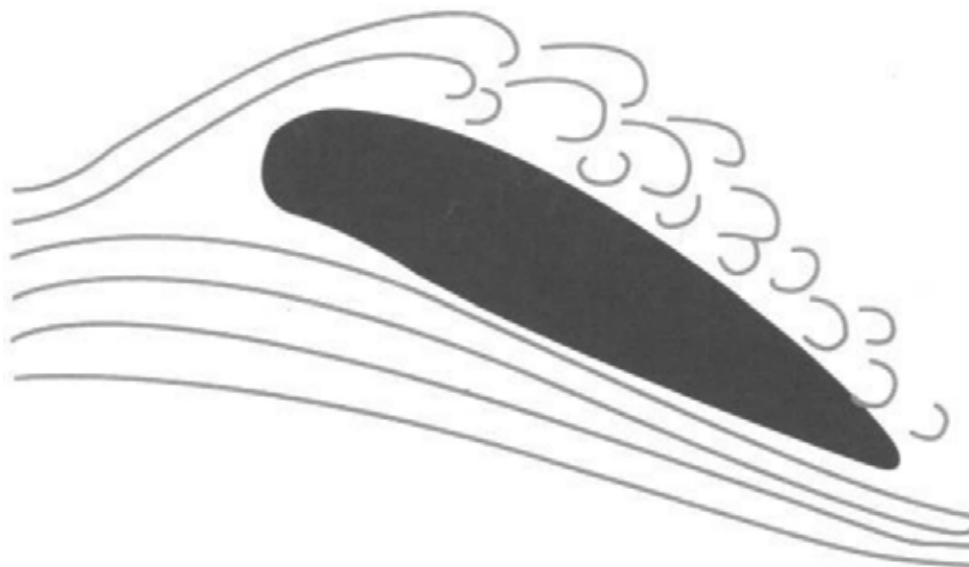

Figure A-9 Stall

Note. From *From the Ground Up: Millennium Edition* (p. 35), by A. F. MacDonald and I. L. Pepler, 2000, Ottawa, ON: Aviation Publishers Co. Limited. Copyright 2000 by Aviation Publishers Co. Limited.



STALL SPEED, POWER OFF			
GROSS WEIGHT 2800 LBS.	ANGLE OF BANK		
	 0°	 30°	 60°
CONFIGURATION			
FLAPS UP	64	69	91
FLAPS 20°	57	61	81
FLAPS 40°	55	59	78

Figure A-10 Stall Speed in Turns

Note. From *From the Ground Up: Millennium Edition* (p. 35), by A. F. MacDonald and I. L. Pepler, 2000, Ottawa, ON: Aviation Publishers Co. Limited. Copyright 2000 by Aviation Publishers Co. Limited.

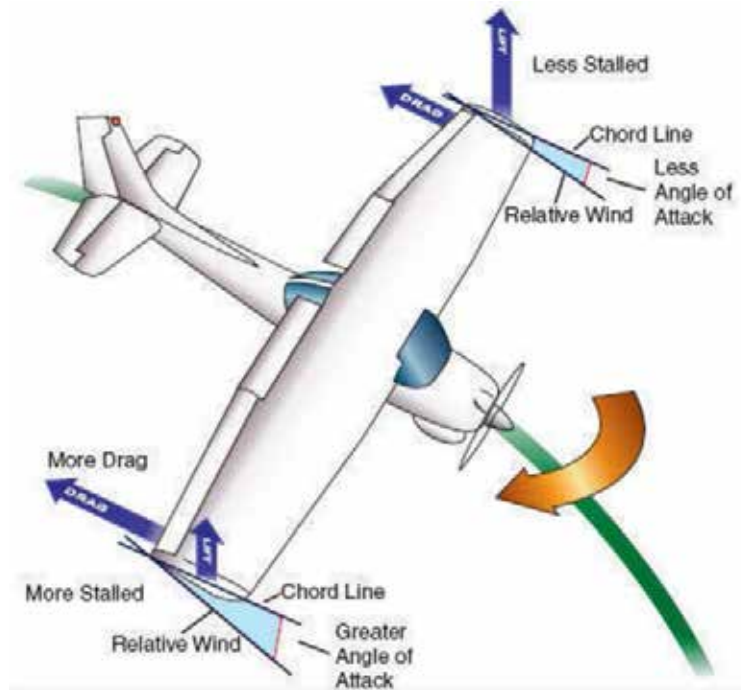

Figure A-11 Spin

Note. From "What is a Spin?", *Over the Airwaves*. Retrieved November 12, 2008, from <http://overtheairwaves.com/Vol3-111.jpg>

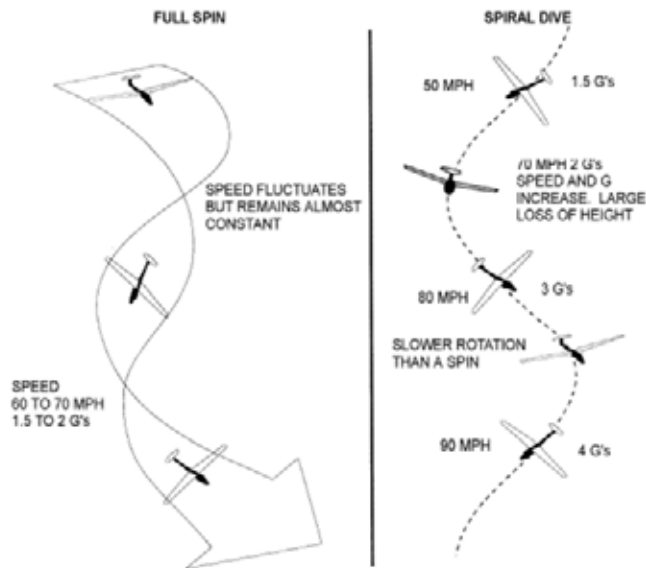

Figure A-12 Spin and Spiral Recognition

Note. From *Air Cadet Gliding Program Manual* (p. 6-6-4), by Air Force Training, 2009, Ottawa, ON: Department of National Defence.



**ROYAL CANADIAN AIR CADETS
PROFICIENCY LEVEL FOUR
INSTRUCTIONAL GUIDE**



SECTION 4

EO C431.02 – DEMONSTRATE TURNS, CLIMBS AND DESCENTS IN A FLIGHT SIMULATOR

Total Time: 90 min

PREPARATION

PRE-LESSON INSTRUCTIONS

Resources needed for the delivery of this lesson are listed in the lesson specification located in A-CR-CCP-804/PG-001, *Proficiency Level Four Qualification Standard and Plan*, Chapter 4. Specific uses for said resources are identified throughout the instructional guide within the TP for which they are required.

Review the lesson content and become familiar with the material prior to delivering the lesson.

Photocopy the handouts located at Attachments A and B for each cadet.

Create a scenario (eg, location, weather, aircraft) for the aircraft flight simulator IAW the manual provided with the software.

Set up the simulator with the scenario created.

PRE-LESSON ASSIGNMENT

Nil.

APPROACH

An interactive lecture was chosen for TPs 1 and 2 to give direction on procedures and present basic or background information about flight simulation.

A demonstration and performance was chosen for TP 3 as it allows the instructor to explain and demonstrate turns, climbs and descents in a flight simulator while providing an opportunity for the cadets to practice the skills under supervision.

INTRODUCTION

REVIEW

Nil.

OBJECTIVES

By the end of this lesson the cadet shall have demonstrated turns, climbs and descents in a flight simulator.

IMPORTANCE

It is important for cadets to demonstrate turns, climbs and descents in a flight simulator to develop a better understanding of the principles of flight and stimulate an interest in aviation. This will also serve as a solid foundation for any cadet who participates in a demonstration flight or flying training in the future.

Teaching Point 1**Explain any safety considerations related to the location or design of the flight simulator.**

Time: 5 min

Method: Interactive Lecture



Arrange the cadets so they can hear the safety briefing prior to using the flight simulator.



This briefing is being conducted to pass on safety considerations for use of the flight simulator. The actual content of the briefing will vary by region and squadron based on the squadron assets, the location of the assets, and other environmental factors. However, the following should be covered:

- DND regulations concerning the appropriate use of computers, including:
 - CATO 11-07, *Internet Acceptable Use—Cadet Program*,
 - DAOD 6001, *Internet*, and
 - Regional Orders;
- location of the nearest fire exit in case of fire,
- awareness of any moving parts of the simulator, and
- proper entry and exit techniques to avoid damage to assets.

CONFIRMATION OF TEACHING POINT 1

Confirmation questions for this TP will depend on the content covered.

Teaching Point 2**Explain how to manipulate the necessary control inputs and the location of necessary instruments.**

Time: 10 min

Method: Interactive Lecture

NECESSARY CONTROL INPUTS**Control Column or Yoke**

Using a control yoke in a flight simulator is preferable. Accordingly, the following will need to be adjusted if a control column is used instead.

The control yoke is located directly in front of the pilot in the centre of the pilot's side of the instrument panel. The control yoke is very much like the steering wheel of a car, both in look and function. The yoke is designed to move on two planes of motion.

The first plane of motion is left and right. The control yoke will usually move to approximately 45 degrees left or right of centre when moved like a steering wheel. This motion is what controls the ailerons of the simulated airplane. To roll left, turn the yoke left. To roll right, turn the yoke right. Remember, this must be used as well as the rudder in order to properly turn the aircraft.

The control yoke also moves back and forth. The steering column of the yoke moves in and out of the main assembly. This controls the elevator of the simulated aircraft. To pitch up, pull back (towards the pilot). To pitch down, push forward (away from the pilot).



Pitch will change the altitude, but more importantly the airspeed.

Rudder Pedals

On the floor of the simulator there are two pedals. If the left pedal is pushed forward, the right one moves back and vice versa. These pedals control the rudder of the simulated aircraft. To yaw left, push on the left pedal. To yaw right, push on the right pedal.



Rudder pedals move in different directions so pressure must be taken off the opposite pedal in order for the movement to take place.

LOCATION OF NECESSARY INSTRUMENTS



Distribute the handout located at Attachment A to each cadet.

The instruments of the simulated aircraft will be displayed in front of the pilot, laid out above the control yoke on what is called an instrument panel. The four instruments that are of significance are the airspeed indicator (ASI), vertical speed indicator (VSI), altimeter, and turn coordinator.

ASI. Shows an aircraft's speed through the air.

VSI. Shows the rate at which an aircraft is ascending or descending.

Altimeter. Shows the altitude of an aircraft.

Turn Coordinator. Shows rate of roll as well as the rate of turn of the aircraft.



Function of the ASI, VSI, altimeter and turn coordinator was discussed in M431.02 (Describe Flight Instruments).

CONFIRMATION OF TEACHING POINT 2**QUESTIONS:**

- Q1. Where is the control yoke located?
- Q2. Where are the instruments located?
- Q3. How is pitch controlled?

ANTICIPATED ANSWERS:

- A1. Directly in front of the pilot in the centre of the pilot's side of the instrument panel.
- A2. In front of the pilot, laid out above the control yoke on what is called an instrument panel.
- A3. By moving the yoke towards or away from the pilot.

Teaching Point 3

Explain, demonstrate and have the cadets practice turns, climbs and descents using a flight simulator.

Time: 70 min

Method: Demonstration and Performance

ACTIVITY**OBJECTIVE**

The objective of this activity is to allow the cadets to practice turns, climbs and descents and witness their effect on the pitot static instruments and the turn coordinator.

RESOURCES

- flight simulator (Microsoft flight simulator, computer, control yoke, and rudder pedals; or Link),
- scenario using a local airport, no weather, and positioned 1 000 feet above ground level (AGL), and
- Climbs, Turns and Descents Handout located at Attachment B.

ACTIVITY LAYOUT

Training should be conducted for a light training single engine aircraft such as:

- a Cessna 172, or
- a Piper J-3C-65 Cub.

This will depend on the location of the flight simulator.

ACTIVITY INSTRUCTIONS

1. Start the simulator with the scenario created prior to the lesson.
2. Using the flight simulator, explain and demonstrate turns, climbs and descents by climbing to 5 000 feet AGL, making turns and descending to 1 000 feet AGL.



Specific details on how to conduct turns, climbs and descents can be found in:

- the Transport Canada *Flight Training Manual*,
- the *Computerized Aircraft Simulation Center*,
- the Pilots Operating Handbook (POH), and / or
- the operating instructions for the flight simulator program.

3. Distribute the handout located at Attachment B to each cadet. The handout reflects the sequence in which the instructor will explain and demonstrate turns, climbs and descents.
4. Have the cadets take turns in the flight simulator, practicing turns, climbs and descents as demonstrated.
5. Give each cadet verbal and physical assistance as necessary as they practice turns, climbs and descents.
6. Provide each cadet an equal amount of time. This means that the 70 minutes should be divided as evenly as possible based on the number of cadets in the class and the number of flight simulators available.
7. Debrief each cadet as they finish their individual flight. The debrief should include the following:
 - a. the overall performance of the cadet,
 - b. the sequences where the cadet performed strongly,
 - c. the sequences where the cadet performed weakly, and
 - d. how to improve their performance.

SAFETY

Nil.

CONFIRMATION OF TEACHING POINT 3

The cadets' participation in the activity will serve as the confirmation of this TP.

END OF LESSON CONFIRMATION

The cadets' participation in practicing turns, climbs and descents in the flight simulator will serve as the confirmation of this lesson.

CONCLUSION

HOMEWORK / READING / PRACTICE

Nil.

METHOD OF EVALUATION

Nil.

CLOSING STATEMENT

It has been stated by many flight instructors that a significant difference can be seen in the quality of students who used a flight simulator compared to those who did not. The military is a large user of computer-based flight simulators, as are Air Canada and WestJet. Continued training on flight simulators will enhance preparation for future flight training.

INSTRUCTOR NOTES / REMARKS

All staff should be familiarized with the operation of the flight simulator prior to the cadets arriving. This will allow them to troubleshoot, and give them a better perspective for instructing.

Additional instructors are required for this lesson. There should be one instructor per two flight simulators.

Cadets who are qualified Advanced Aviation may assist with this instruction.

REFERENCES

C3-139 ISBN 0-7715511-5-0 Transport Canada. (1999). *Flight training manual 4th edition revised*. Ottawa, ON: Transport Canada.

C3-156 *Computerized Aircraft Simulation Center*. (2007). Retrieved October 2, 2007, from http://www.regions.cadets.forces.gc.ca/pac/aircad/flight/casc_lessons_e.asp

THIS PAGE INTENTIONALLY LEFT BLANK



Figure A-1 Cessna Flight Instrument Panel

Note. From "Design a Virtual Cockpit Instrument Panel", Ngee Ann Polytechnic, 2007. Retrieved October 31, 2007, from <http://www.learnerstogether.net/avionics-project-design-problem-based-learning/56>

THIS PAGE INTENTIONALLY LEFT BLANK

CLIMBS, TURNS AND DESCENTS HANDOUT

The handout is presented to reflect the sequence in which the instructor will explain and demonstrate climbs, turns and descents.

CLIMBS

Climbs are executed by doing the following:

1. Adjust the pitch angle to obtain climb airspeed.
2. Increase the power to maintain airspeed.
3. Climb to the desired altitude.
4. Upon reaching the desired altitude, resume a level attitude and adjust power to maintain altitude and airspeed.
5. For any climb, follow the sequence: attitude, power, trim (APT).

TURNS

Turns are executed by doing the following:

1. Look out from the outside to the inside of the turn. A good look out is the most important part of airmanship as is essential for safe flying.
2. Roll the airplane in the desired direction, using the rudder to stay coordinated. Stay coordinated by "stepping on the ball" of the turn coordinator. That is, if the ball of the turn coordinator is to the right, apply more right rudder and vice versa.
3. Once the desired angle of bank has been reached, reduce the yoke input as required to maintain that angle of bank.

Gentle turn. A turn with up to 15 degrees angle of bank.

Medium turn. A turn with approximately 30 degrees angle of bank.

Steep turn. A turn with at least 45 degrees angle of bank. When executing a steep turn, as the angle of bank passes 30 degrees, back-stick pressure must be applied to maintain attitude and altitude. The power setting must be increased to maintain altitude.

DESCENTS

Descents are executed by doing the following:

1. Decrease power, adjust the attitude to reach and maintain the descent speed, and adjust the trim.
2. For any descent, follow the sequence: power, attitude, trim (PAT).
3. Upon reaching the desired altitude, resume a level attitude and adjust power to maintain altitude and airspeed.

THIS PAGE INTENTIONALLY LEFT BLANK



**ROYAL CANADIAN AIR CADETS
PROFICIENCY LEVEL FOUR
INSTRUCTIONAL GUIDE**



SECTION 5

EO C431.03 – FLY A RADIO-CONTROLLED AIRCRAFT

Total Time:	90 min
-------------	--------

PREPARATION

PRE-LESSON INSTRUCTIONS

Resources needed for the delivery of this lesson are listed in the lesson specification located in A-CR-CCP-804/PG-001, *Proficiency Level Four Qualification Standard and Plan*, Chapter 4. Specific uses for said resources are identified throughout the instructional guide within the TP for which they are required.

Review the lesson content and become familiar with the material prior to delivering the lesson.

Construct and / or assemble a radio-controlled aircraft for use by cadets.

Charge multiple batteries for use with radio-controlled aircraft.

Assistant instructors are required for this lesson.

PRE-LESSON ASSIGNMENT

Nil.

APPROACH

A practical activity was chosen for this lesson as it is an interactive way to introduce the cadets to flying a radio-controlled aircraft in a safe and controlled environment. This activity contributes to the development of skills and knowledge in a fun and challenging setting.

INTRODUCTION

REVIEW

Nil.

OBJECTIVES

By the end of this lesson the cadet shall have flown a radio-controlled aircraft.

IMPORTANCE

It is important for cadets to fly a radio-controlled aircraft as it provides an opportunity to apply the principles of flight in a fun and practical way.

Teaching Point 1

IAW the instructions supplied with the radio-controlled aircraft and the Model Aeronautics Association of Canada (MAAC) safety code, have the cadet fly a radio-controlled aircraft.

Time: 80 min

Method: Practical Activity

BACKGROUND KNOWLEDGE

Radio-Controlled Aircraft

Radio-controlled aircraft are more complicated and expensive than free-flight gliders or rubber-powered airplanes. They are an exciting way to apply the principles of flight in a practical way. They can be scratch-built from plans, built from kits, assembled from almost-ready-to-fly (ARF) kits, or assembled from ready-to-fly (RTF) packages.

Small, light-weight, electric-powered helicopters are also a viable alternative to a conventional radio-controlled airplane. They are available in different sizes in RTF packages and can be flown indoors in smaller spaces than required by an airplane. Most micro-helicopters on the market use counter-rotating main rotors that make a stable, easy-to-hover helicopter.



The Blade CX Series (CX, CX2, CX3 and MCX), from E-Flite are among the most popular entry-level helicopters. They come in an RTF package and include a radio transmitter-receiver combination that allows multiple aircraft to operate at the same time without interference.

Figures 1 and 2 show the Blade CX2 and Blade MCX, respectively.

When learning to operate a radio-controlled helicopter, it is recommended that a training gear set is attached to the landing skids to reduce rollovers as shown in Figure 3.

Ensure that there is an ample supply of spare parts (blades, shafts, and heads) available to repair any damages caused by a crash.

Having multiple batteries available (a minimum of three per helicopter) minimizes the time spent waiting while batteries are recharging.



Figure 1 Blade CX2

Note. From "Horizon Hobby", *E-Flite Blade CX2*. Retrieved November 5, 2008, from <http://www.horizonhobby.com/Products/Gallery.aspx?ProdID=EFLH1250&Index=0>



Figure 2 Blade MCX

Note. From "Horizon Hobby", *E-Flite Blade MCX*. Retrieved November 5, 2008, from <http://www.horizonhobby.com/Products/Gallery.aspx?ProdID=EFLH2200&Index=4>



Figure 3 Blade CX2 With Training Gear Installed

Note. From "Elite Models", *Blade CX2*. Retrieved November 5, 2008, from <http://www.elitemodelsonline.co.uk/Products/Helicopters/Helicopters+Spares/E-Flite/Blade+CX2>



A radio-controlled airplane can be built easily and quickly from common materials such as corrugated plastic (commonly used for signs) and polyvinyl chloride (PVC) downspout. These simple plastic airplane designs (SPADs) are inexpensive and durable.

Information and free plans for SPADs can be found at <http://www.spadtothebone.com>

The Debonair is designed to be used as a trainer and is shown at Figure 4.



Figure 4 SPAD Debonair

Note. Created by Director Cadets 3, 2008, Ottawa, ON: Department of National Defence.

RTF packages (containing an airframe, engine or motor, radio gear, and hardware) can be assembled in a few hours and generally contain almost everything needed to go flying except for field items such as:

- glue,
- starting equipment, and
- fuel / batteries.



Figure 5 and 6 shows examples of an RTF aircraft suitable for first-time fliers. The Vapor Bind-N-Fly model also comes as the Vapor RTF model which includes the radio transmitter and is for indoor flying only.



Figure 5 Alpha 40 DSM2 RTF

Note. From "Hangar 9", *Alpha 40 DSM2 RTF*. Retrieved November 5, 2008, from <http://www.hangar-9.com/Products/Default.aspx?ProdID=HAN4400>



Figure 6 Vapor Bind-N-Fly

Note. Created by Director Cadets 3, 2008, Ottawa, ON: Department of National Defence.

Computer simulators for radio-controlled aircraft are available and can be used to provide training in a safe and controlled environment without having to worry about the cost and time associated with repairing an aircraft after a crash.

Most of the simulators available come with a "transmitter" that is almost identical to the ones used for real radio-controlled aircraft that plug into the computer through a USB port, and a set of CDs / DVDs to install the program.

Testimonials from many people indicate the number and severity of crashes are reduced by spending time on the simulator prior to flying the radio-controlled aircraft. Additionally, most simulators have many different radio-controlled aircraft included, which allows the pilot to experiment with various aircraft types.



Popular radio-controlled aircraft simulators include:

- RealFlight (Knife Edge Software), and
- FS One (Hangar 9).

ACTIVITY

OBJECTIVE

The objective of this activity is to have the cadets fly a radio-controlled aircraft.

RESOURCES



If an aircraft has to be constructed before flying, complete by:

- setting up a desk or table for each cadet (or group of cadets);
- placing the required construction and / or assembly tools and materials on the tables;
- showing a completed model aircraft to the cadets;
- describing the parts and components of the model aircraft to the cadets; and
- having the cadets construct and / or assemble the model aircraft IAW the plans and / or instructions.

- Radio-controlled aircraft,
- Starting equipment,
- Fuel / batteries,
- Battery charger, and
- Transmitter.

ACTIVITY LAYOUT

Large indoor area (eg, gymnasium or drill hall) or a large outdoor area for flying a radio-controlled aircraft IAW regulations and safety guidelines set out by Model Aeronautics Association of Canada (MAAC).

ACTIVITY INSTRUCTIONS

1. Demonstrate to the cadets how to fly the radio-controlled aircraft to include:
 - a. taking off;
 - b. flying a circuit; and
 - c. landing.
2. Have the cadets fly the radio-controlled aircraft IAW the plans and / or the instructions.

SAFETY

Assistant instructors will monitor the cadets to ensure they are following the instructor's directions and using all equipment safely.



All radio-controlled aircraft activities shall be conducted IAW the regulations and safety guidelines set out by MAAC.

Flying a radio-controlled aircraft should not be attempted without assistance from an experienced radio-controlled aircraft pilot. A list of MAAC sanctioned clubs can be found at http://www.maac.ca/clubs/maac_clubs_map.php.

CONFIRMATION OF TEACHING POINT 1

The cadets' participation in this activity will serve as the confirmation of this TP.

END OF LESSON CONFIRMATION

The cadets' participation in flying a radio-controlled aircraft will serve as the confirmation of this lesson.

CONCLUSION**HOMEWORK / READING / PRACTICE**

Nil.

METHOD OF EVALUATION

Nil.

CLOSING STATEMENT

Flying a radio-controlled aircraft is a fun and challenging way to apply the principles of flight.

INSTRUCTOR NOTES / REMARKS

It is recommended that the three periods required for this EO be scheduled consecutively.

The radio-controlled aircraft can be flown individually or in small groups of two to four cadets.

Assistant instructors are required for this lesson.

Suitable model aircraft may be chosen from the following:

- Blade CX2 / CX3 (radio-controlled electric helicopter),
- Blade MCX (radio-controlled electric helicopter),
- SPAD Debonair (radio-controlled airplane),
- Alpha 40 DSM2 RTF (radio-controlled airplane),
- Vapor Bind-N-Fly / RTF (radio-controlled airplane), and / or
- an alternate choice (or choices) selected by the squadron.

The helicopter being selected should have the counter-rotating rotor system with a 2.4 GHz radio transmitter.

Radio-controlled aircraft simulators such as RealFlight (Knife Edge Software) or FS One (Hangar 9) that run on a personal computer can also be used.

REFERENCES

C3-303 *Model Aeronautics Association of Canada Safety Code*. (2008). Retrieved February 5, 2009, from http://www.maac.ca/docs/2007/maac_safety_code_v008sept30_08_english.pdf



**ROYAL CANADIAN AIR CADETS
PROFICIENCY LEVEL FOUR
INSTRUCTIONAL GUIDE**



SECTION 1

EO M432.01 – DESCRIBE FUEL SYSTEMS

Total Time:	30 min
-------------	--------

PREPARATION

PRE-LESSON INSTRUCTIONS

Resources needed for the delivery of this lesson are listed in the lesson specification located in A-CR-CCP-804/PG-001, *Proficiency Level Four Qualification Standard and Plan*, Chapter 4. Specific uses for said resources are identified throughout the instructional guide within the TP for which they are required.

Review the lesson content and become familiar with the material prior to delivering the lesson.

Prepare slides located at Attachment A.

Photocopy the handout located at Attachment B for each cadet.

PRE-LESSON ASSIGNMENT

Nil.

APPROACH

An interactive lecture was chosen for this lesson to clarify, emphasize, and summarize fuel systems.

INTRODUCTION

REVIEW

Nil.

OBJECTIVES

By the end of this lesson the cadet shall have described fuel systems.

IMPORTANCE

It is important for cadets to be able to describe fuel systems as a solid understanding of fuel systems provides knowledge for potential instructional duties and is part of the fundamentals that cadets pursuing future aviation training will require.

Teaching Point 1**Describe fuel systems.**

Time: 10 min

Method: Interactive Lecture

THE FUEL SYSTEM

An aircraft fuel system stores and delivers the proper amount of fuel for all phases of flight, including:

- normal flight,
- violent manoeuvres,
- sudden acceleration, and
- sudden deceleration.

Fuel systems include the following parts:

- fuel tanks,
- a fuel selector valve,
- fuel lines and filters,
- a fuel quantity gauge, and
- fuel primer.

Pressure-Feed System

Show slide of Figure A-1 to the cadets.

Aircraft with low-wing configurations and large aircraft with a large volume of fuel movement use an engine-driven fuel pump to provide the pressure to keep fuel flowing. This system includes:

- the basic pump,
- auxiliary electric pumps for emergency situations,
- a booster pump to create the pressure required to start the fuel flowing before the engine is running, and
- the pressure gauge mounted on the cockpit panel used to read the pressure of fuel entering the carburetor.

Gravity-Feed System

Show slide of Figure A-2 to the cadets.

High-wing, low-powered light aircraft use the gravity-feed system. The bottom of the fuel tank in the wing must be high enough to provide pressure for the fuel to travel past the fuel selector to the carburetor.

Fuel Selector Valve

The fuel selector valve is used by the pilot to select the desired fuel tank to draw fuel. The selector valve may also be used to shut off the flow of fuel from the tanks.



A fuel selector valve can be operated manually or electrically depending of the installation.

FUEL

Aviation fuel has been specially formulated for use in aircraft. It is available in several different types / grades. The approved fuel types are specified in the pilot operating handbook.

Fuel Types

Fuel used in modern high compression engines must burn slowly and expand evenly rather than explode quickly (detonation). High octane fuels meet this requirement. The octane rating of fuels is calculated by the ratio of octane and heptane.

Octane. A substance which possesses minimum detonating qualities.

Heptane. A substance which possesses maximum detonating qualities.



Show slide of Figure A-3 to the cadets.



Proportion of octane to heptane is expressed as a percentage. For example 73 octane means 73 percent octane and 27 percent heptane.

Higher octane fuels are treated with sulphuric acid, lye, etc, used to remove the gum, acid, and other impurities.

Octane numbers can only go as high as 100. Beyond this, the performance number is the anti-knock value of the fuel for octane numbers above 100. Fuel grades are expressed by two performance numbers the first number indicates octane rating at lean mixture conditions, and the second number indicates octane rating at rich mixture condition.



Grade 100 / 130 indicates:

- lean mixture performance number of 100, and
- rich mixture performance number of 130.

CONFIRMATION OF TEACHING POINT 1

QUESTIONS:

- Q1. What fuel-feed system does an aircraft with low-wing configuration use?
- Q2. For what is the fuel selector valve used?
- Q3. How are octane ratings of fuels calculated?

ANTICIPATED ANSWERS:

- A1. An aircraft with low-wing configuration uses a pressure-feed system.
- A2. The fuel selector valve is used by the pilot to select the desired fuel tank to draw fuel. The selector valve may also be used to shut off the flow of fuel from the tanks.
- A3. Octane ratings of fuels are calculated as a ratio of octane and heptane.

Teaching Point 2

Describe carburetors.

Time: 10 min

Method: Interactive Lecture

CARBURETORS



Show slide of Figure A-4 to the cadets.

The heat energy in an internal combustion engine is developed from the burning of a mixture of gasoline and air. The carburetor measures the correct quantity of gasoline, vaporizes fuel, mixes it with the air in the required proportion and delivers the mixture to the cylinder when the combustion occurs.

An engine will run hotter with a lean mixture than a rich mixture as the lean mixture will burn slower and the cylinder walls are exposed to high heat for a longer time. A rich mixture burns quickly exposing the cylinder walls to high temperatures for a shorter time and the additional fuel in the fuel / air mix cools the engine.

The carburetor involves numerous complex devices to control the mixture ratio. Two types of carburetors used, include float carburetor, or pressure carburetor.

Float Carburetor



Show slide of Figure A-5 to the cadets.

Fuel flows through the fuel lines, enters the carburetor at the float valve and into the float chamber. A needle attached to the float, resting on the fuel within the chamber, opens and closes an opening at the bottom of the carburetor bowl. The float chamber is vented so the atmospheric and chamber pressure equalizes as the aircraft climbs and descends.

Air flows through an air filter usually located at an air intake in the front part of the engine cowling. The filtered air flows into the carburetor through a venturi (narrow throat in the carburetor). The air speed increases, creating a low pressure area which draws fuel at atmospheric pressure.

The air and vaporized fuel is regulated, in volume, by the throttle valve, enters the intake manifold and is distributed to the individual cylinders. The pilot is able to control the amount of fuel / air mixture from within the cockpit using the throttle control.



Forward movement of the throttle opens the throttle valve, which increases the fuel / air mixture, and increases the power being produced by the engine.

Aft movement of the throttle closes the throttle valve, which reduces the volume of fuel / air mixture, and decreases the power being produced by the engine.

Mixture Control



The correct fuel / air mixture will be obtained at sea level as carburetors are normally calibrated for sea level operation.

As altitude increases, the density of the air decreases and a given volume of air weighs less. The proportion of air by weight to that of fuel will become less although the volume remains the same. The mixture at higher altitude becomes over-rich causing fuel waste and loss of power.

A mixture control is fitted to the carburetor that adjusts the amount of fuel being drawn from the nozzle, restoring the proper fuel / air mix.

The general rules when using a manual mixture control are:

- rich mixtures—high power settings, and
- leaner mixtures—cruise power settings.

Carburetor Icing



Show slide of Figure A-6 to the cadets.

Distribute the handout located at Attachment B to each cadet.

With temperatures ranging from minus 5 degrees Celsius to plus 30 degrees Celsius and under certain moist atmospheric conditions, ice can form in the induction system closing off the flow of fuel to the engine. Ice can form on various surfaces of the carburetor especially on the throttle.



Show slide of Figure A-7 to the cadets.



Modern aircraft have incorporated a method of directing heated air into the carburetor air intake, activated by the carburetor hot air handle in the cockpit. This heated air can prevent ice from forming or melt ice that has already formed.

CONFIRMATION OF TEACHING POINT 2

QUESTIONS:

- Q1. How are the fuel / air proportions calculated?
- Q2. What does the mixture control adjust?
- Q3. What do modern aircraft have to melt ice that has formed?

ANTICIPATED ANSWERS:

- A1. Fuel / air proportions are calculated by weight not volume.
- A2. The mixture control adjusts the amount of fuel being drawn from the nozzle, restoring the proper fuel / air mix.
- A3. Modern aircraft have incorporated a method of directing heated air into the carburetor air intake, activated by the carburetor hot air handle in the cockpit.

Teaching Point 3

Describe fuel injection.

Time: 5 min

Method: Interactive Lecture

FUEL INJECTION

With a fuel injection system, a control valve supplies pressurized fuel continuously to the induction system near the intake valve. The fuel is vaporized and sucked into the cylinder during the intake stroke.

Advantages of fuel injection include:

- more uniform distribution of fuel to all cylinders,
- better cooling, through the elimination of lean hot mixtures to some of the more distant cylinders,
- fuel saving through uniform distribution,
- increased power since the heat carburetor air is eliminated, and
- elimination of the hazard of carburetor icing.



Throttle ice can occur when the temperature is less than 5 degrees Celsius. Impact ice can gather in bends in the system, impact tubes, and air filter.

CONFIRMATION OF TEACHING POINT 3**QUESTIONS:**

- Q1. What does the control valve do?
- Q2. What are the advantages of fuel injection?
- Q3. Where can impact ice gather?

ANTICIPATED ANSWERS:

- A1. The control valve supplies pressurized fuel continuously to the induction system near the intake valve.
- A2. Advantages of fuel injection include:
- more uniform distribution of fuel to all cylinders,
 - better cooling, through the elimination of lean hot mixtures to some of the more distant cylinders,
 - fuel saving through uniform distribution,
 - increased power since the heat carburetor air is eliminated, and
 - elimination of the hazard of carburetor icing
- A3. Impact ice can gather in the system, impact tubes, and air filter.

END OF LESSON CONFIRMATION**QUESTIONS:**

- Q1. What fuel-feed system does a high-wing, low-powered light aircraft use?
- Q2. Why is leaning the engine both practical and economical?
- Q3. When can throttle ice occur?

ANTICIPATED ANSWERS:

- A1. A high-wing, low-powered light aircraft uses a gravity-feed system.
- A2. It results in:
- better fuel economy lowering the cost of operation,
 - a smoother running engine,
 - a more efficient engine giving higher indicated airspeeds and better aircraft performance,
 - extended range of the aircraft at cruise,
 - less spark plug fouling and longer life for spark plugs,
 - more desirable engine temperatures, and
 - cleaner combustion chambers and less chance of pre-ignition from undesirable deposits.
- A3. Throttle ice can occur when the temperature is less than 5 degrees Celsius.

CONCLUSION

HOMEWORK / READING / PRACTICE

Nil.

METHOD OF EVALUATION

This EO is assessed IAW A-CR-CCP-804/PG-001, *Proficiency Level Four Qualification Standard and Plan*, Chapter 3, Annex B, Aviation Subjects–Combined Assessment PC.

CLOSING STATEMENT

Being able to describe fuel systems is important for understanding more complex material. A solid understanding of aero engines is required to pursue future aviation training.

INSTRUCTOR NOTES / REMARKS

Cadets who are qualified Advanced Aviation may assist with this instruction.

REFERENCES

C3-116 ISBN 0-9680390-5-7 MacDonald, A. F., & Peppler, I. L. (2000). *From the ground up: Millennium edition*. Ottawa, ON: Aviation Publishers Co. Limited.

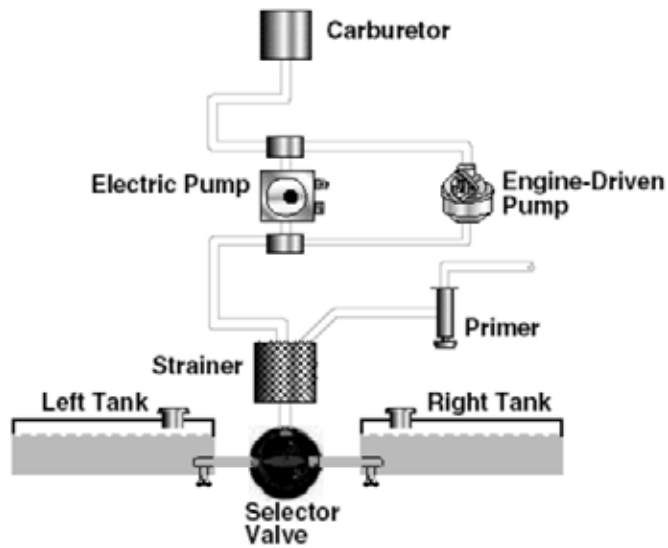

Figure A-1 Pressure-Feed System

Note. From "Online Free Private Pilot Ground School", *The Aircraft Powerplant*. Retrieved November 24, 2008, from <http://www.free-online-private-pilot-ground-school.com/aircraft-powerplant.html>

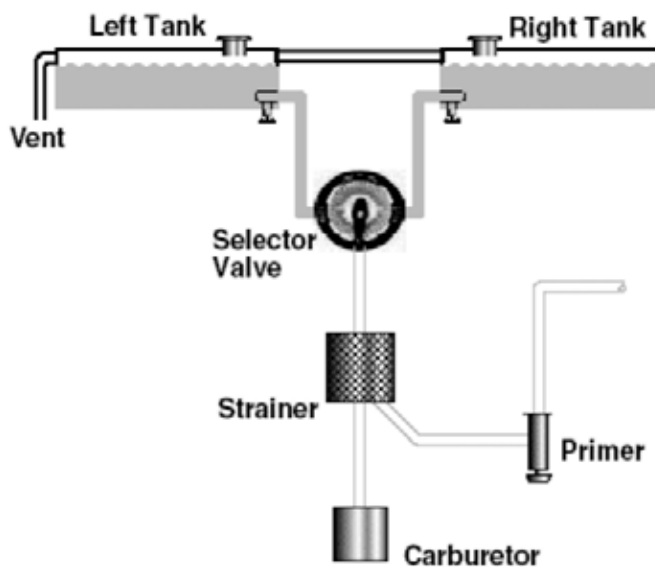

Figure A-2 Gravity-Feed System

Note. From "Online Free Private Pilot Ground School", *The Aircraft Powerplant*. Retrieved November 24, 2008, from <http://www.free-online-private-pilot-ground-school.com/aircraft-powerplant.html>





FUEL TYPE AND GRADE	COLOR OF FUEL	EQUIPMENT COLOR
AVGAS 80	RED	
AVGAS 100	GREEN	
AVGAS 100LL	BLUE	
JET A	COLORLESS OR STRAW	

Figure A-3 Fuel Types

Note. From "Online Free Private Pilot Ground School", *The Aircraft Powerplant*. Retrieved November 24, 2008, from <http://www.free-online-private-pilot-ground-school.com/aircraft-powerplant.html>

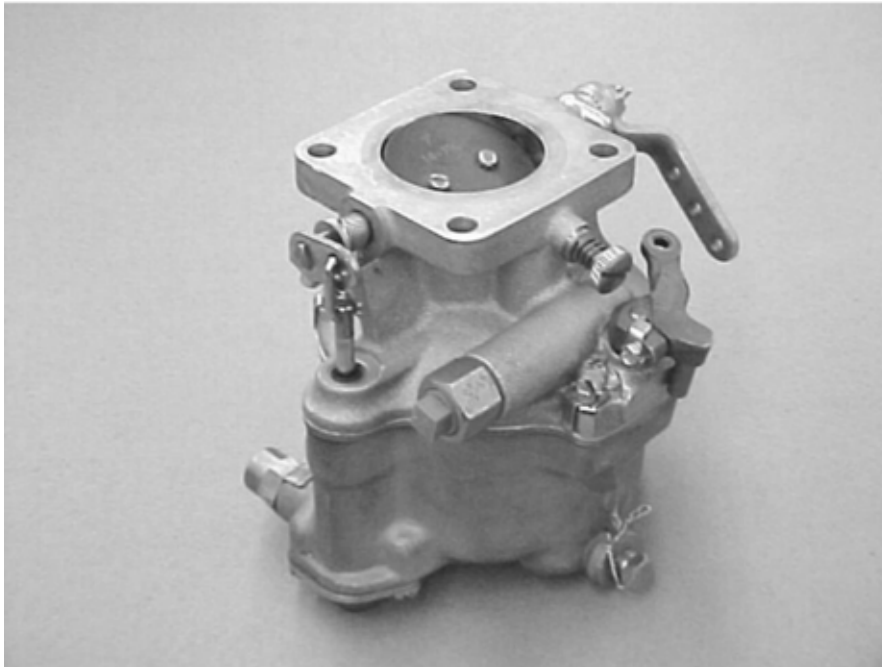

Figure A-4 Carburetor

Note. From "Online Free Private Pilot Ground School", *The Aircraft Powerplant*. Retrieved November 24, 2008, from <http://www.free-online-private-pilot-ground-school.com/aircraft-powerplant.html>

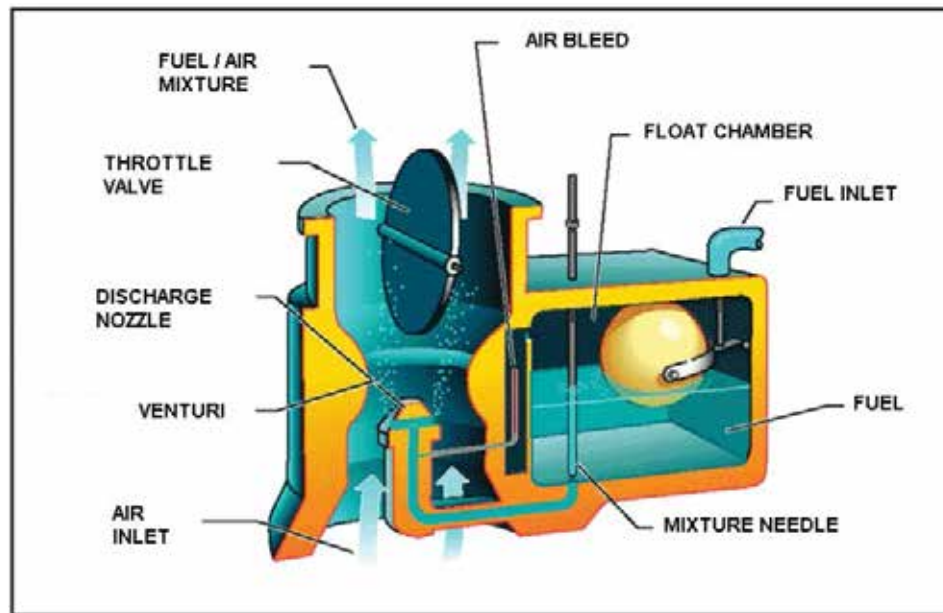

Figure A-5 Float-Type Carburetor

Note. From "Online Free Private Pilot Ground School", *The Aircraft Powerplant*. Retrieved November 26, 2008, from <http://www.free-online-private-pilot-ground-school.com/aircraft-powerplant.html>

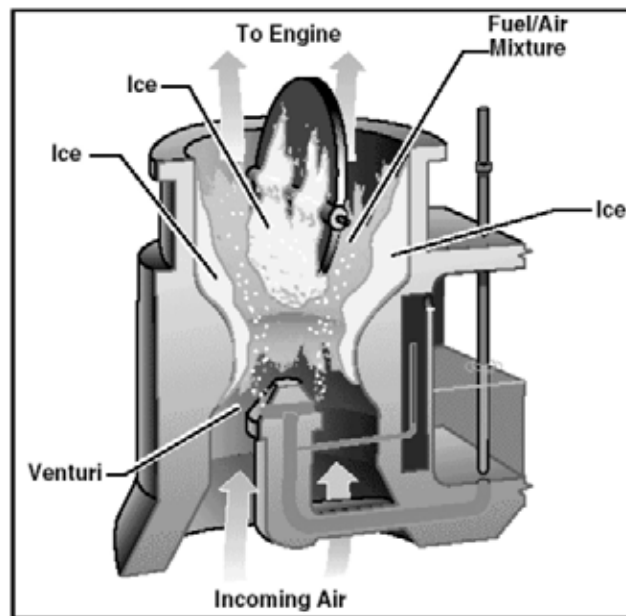

Figure A-6 Carburetor Icing

Note. From "Online Free Private Pilot Ground School", *The Aircraft Powerplant*. Retrieved November 26, 2008, from <http://www.free-online-private-pilot-ground-school.com/aircraft-powerplant.html>

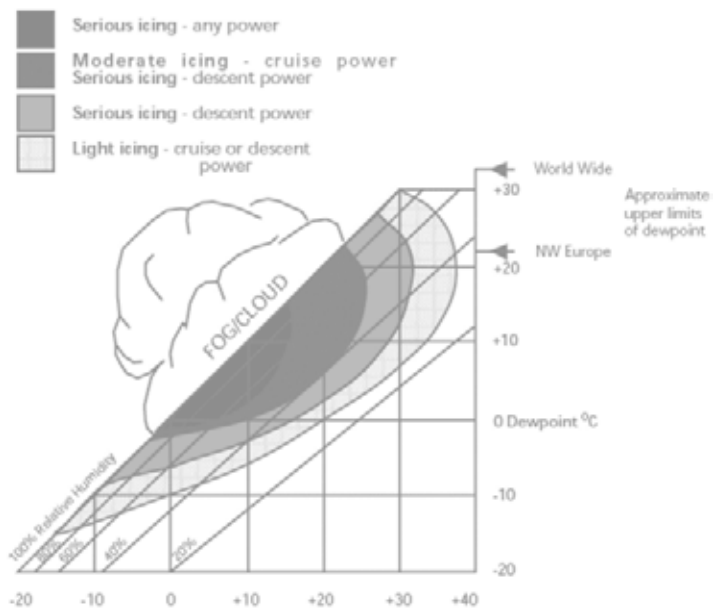

Figure A-7 Carburetor Icing Chart

Note. From "VAF Vansairforce.net", *The Truth about Carb Icing*, by J. Oldenkamp, 2006, Soonabe, FL. Retrieved November 27, 2008, from <http://www.vansairforce.com/community/showthread.php?t=9499>

CARBURETOR STUDY HANDOUT

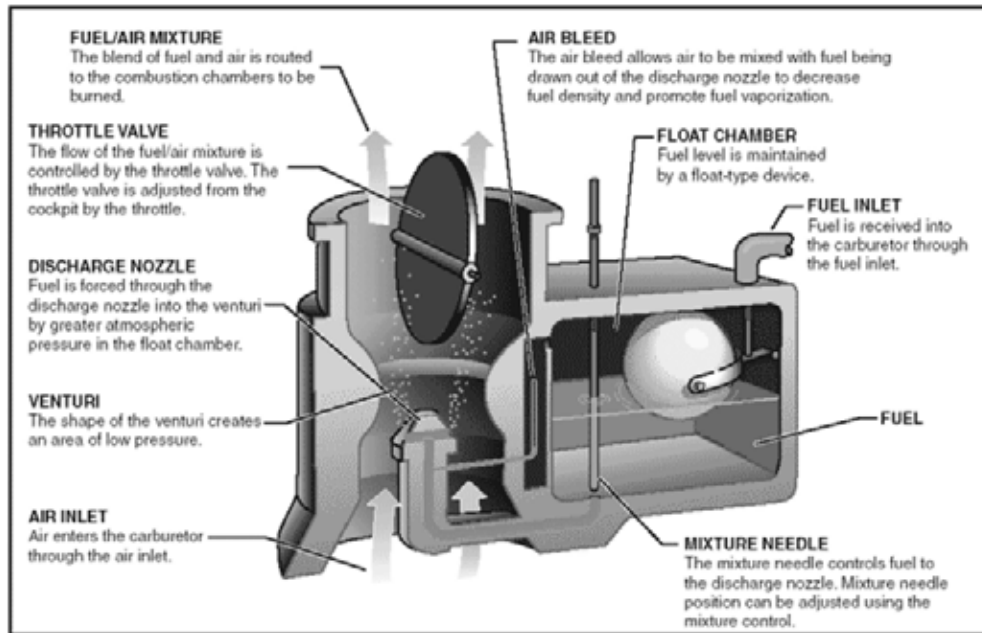

Figure B-1 Float-type Carburetor

Note. From "Online Free Private Pilot Ground School", *The Aircraft Powerplant*. Retrieved November 26, 2008, from <http://www.free-online-private-pilot-ground-school.com/aircraft-powerplant.html>

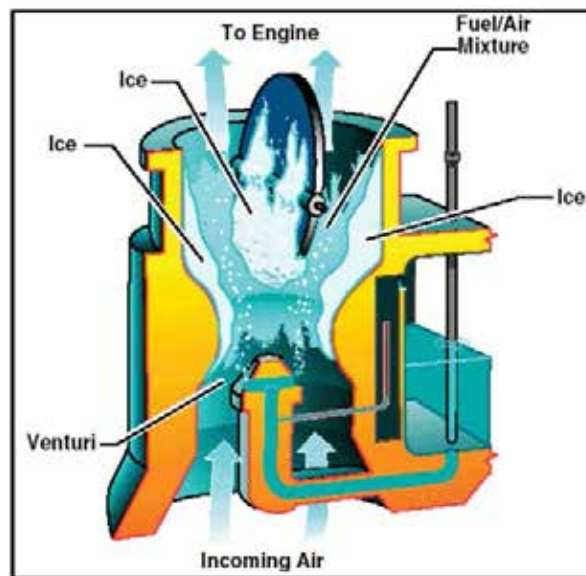

Figure B-2 Carburetor Icing

Note. From "Online Free Private Pilot Ground School", *The Aircraft Powerplant*. Retrieved November 26, 2008, from <http://www.free-online-private-pilot-ground-school.com/aircraft-powerplant.html>

THIS PAGE INTENTIONALLY LEFT BLANK



**ROYAL CANADIAN AIR CADETS
PROFICIENCY LEVEL FOUR
INSTRUCTIONAL GUIDE**



SECTION 2

EO M432.02 – DESCRIBE PROPELLER SYSTEMS

Total Time: 30 min

PREPARATION

PRE-LESSON INSTRUCTIONS

Resources needed for the delivery of this lesson are listed in the lesson specification located in A-CR-CCP-804/PG-001, *Proficiency Level Four Qualification Standard and Plan*, Chapter 4. Specific uses for said resources are identified throughout the instructional guide within the TP for which they are required.

Review the lesson content and become familiar with the material prior to delivering the lesson.

Prepare slides located at Attachment A.

PRE-LESSON ASSIGNMENT

Nil.

APPROACH

An interactive lecture was chosen for this lesson to clarify, emphasize, and summarize propeller systems.

INTRODUCTION

REVIEW

Nil.

OBJECTIVES

By the end of this lesson the cadet shall have described propeller systems.

IMPORTANCE

It is important for cadets to be able to describe propeller systems as a solid understanding of propeller systems provides knowledge for potential instructional duties and is part of the fundamentals that cadets pursuing future aviation training will require.

Teaching Point 1**Describe propeller systems.**

Time: 10 min

Method: Interactive Lecture

The propeller provides the necessary thrust to pull, or in some cases push, the airplane through the air. The engine power rotates the propeller that generates thrust very similar to the manner in which a wing produces lift.

The propeller is a rotating airfoil designed to push air backward as it moves forward along a corkscrew (helical) path. It meets the air at an angle of attack as it rotates, producing thrust (lift) and torque (drag).



Propeller torque is different than engine crankshaft torque in that propeller torque is drag. It is the resistance to the blades as they rotate, resulting in a tendency in the aircraft to roll in a direction opposite to the rotation of the propeller. Engine crankshaft torque is the turning moment produced at the crankshaft. When the propeller is revolving at a constant rpm, propeller torque and engine torque will be exactly equal and opposite.



Show slide of Figure A-1 to the cadets.

A typical propeller is twisted so the blade angles and tapers from the hub to the tip. The highest angle of incidence (pitch) is at the hub and the smallest pitch is at the tip.



Show slide of Figure A-2 to the cadets.

By means of the variation in airfoil sections and the angle of attack, uniform thrust is maintained throughout most of the diameter of the propeller.



Show slide of Figure A-3 to the cadets.



Tractors are propellers attached forward of the engine that pull from the front of the aircraft.
Pushers are propellers attached aft of the engine that push from behind the aircraft.

Pitch. The distance in feet a propeller travels forward in one revolution. Propeller pitch is the difference between theoretical pitch (geometric pitch) and practical pitch (effective pitch).

Theoretical pitch. The distance travelled forward in one revolution if the propeller was working in a perfect fluid. This depends on the blade angle and diameter of the propeller.

Practical pitch. The distance the propeller travels in air in one revolution. The forward motion is less than theoretical pitch.

The angle of the blade, like the angle of incidence of a wing, governs the pitch. The propeller set in coarse pitch will travel a greater distance with each revolution. The aircraft will move forward at greater speed for a given rpm.

The propeller set in fine pitch will have less torque (drag) and will revolve at a higher speed around its axis. The engine will produce greater power. A fine pitch propeller will be good for taking off and climbing but a coarse pitch propeller will develop high cruise speed with comparatively low engine rpm giving good fuel economy.

CONFIRMATION OF TEACHING POINT 1

QUESTIONS:

- Q1. What does the propeller provide?
- Q2. What is propeller torque?
- Q3. For what is a fine pitch propeller good?

ANTICIPATED ANSWERS:

- A1. The propeller provides the necessary thrust to pull, or in some cases push, the airplane through the air.
- A2. It is the resistance to the blades as they rotate, resulting in a tendency in the aircraft to roll in a direction opposite to the rotation of the propeller.
- A3. A fine pitch propeller will be good for taking off and climbing.

Teaching Point 2

Describe types of propellers.

Time: 10 min

Method: Interactive Lecture

FIXED PITCH PROPELLERS

Fixed pitch propeller. The blade angle can not be adjusted by the pilot and is used on most training aircraft. The blade angle is set by the manufacturer to provide the best compromise for all flight conditions.

VARIABLE PITCH PROPELLERS

Adjustable pitch propeller. The blade angle can be changed on the ground to adjust for the varying flight situations such as changed takeoff and climb needs.

Controllable pitch propeller. The blade angles can be adjusted by the pilot during flight. The propeller set in a fine pitch for takeoff allows the engine to develop maximum power. The propeller is then adjusted to a coarse pitch to accelerate at a rapid rate to the desired cruise speed.

Constant speed propeller. The blade angles automatically adjust themselves to maintain a constant rpm as set by the pilot.

The mechanism for adjusting the pitch of the propeller includes:

- mechanical,
- hydraulic, and
- electrical.

Mechanical variable pitch propeller. The pilot adjusts this type of propeller by a control on the instrument panel. The control is directly linked to the propeller which has stop sets to govern the blade angle and travel.

Hydraulic variable pitch propellers. A hydraulically operated cylinder pushes or pulls on a cam connected to gears on the propeller blade. The mechanism can be a counterweight or hydromatic.

The counterweight relies on oil pressure to move the cylinder that twists the blades of a controllable pitch propeller toward fine pitch. The control is adjusted by the pilot in the cockpit.

A constant pitch propeller uses the oil pressure and counterweight principle to twist the blades to the proper pitch angle to maintain a constant rpm. The pilot uses the throttle and propeller control located in the cockpit. The throttle controls the power output of the engine and the propeller control regulates the rpm of both the propeller and the engine.



If oil pressure is lost during flight, the propeller will automatically go into an extreme coarse pitch position where the blades are streamlined and cease to turn (feathered). This system is used in multi-engine aircraft.

A powerful force called centrifugal twisting moment turns the blades toward the fine pitch position of a hydromatic constant speed propeller. The natural force eliminates the use of counterweights. Oil enters the piston chamber under high pressure which moves the piston aft and the blades move into coarse pitch. When the oil enters into the piston chamber under engine pressure, the blades move to fine pitch.



If oil pressure is lost during flight, the propeller will automatically go into fine pitch position, enabling the engine to develop the most power it can and achieve the best performance under the circumstances. This system is used in single-engine aircraft.

Electric variable pitch propellers. An electrical motor turns the blades through a gear speed reducer and bevel gears for an electrical variable pitch propeller. Flyweights open and close electric circuits. One circuit causes a right-hand rotation of the motor and another causes a left-hand rotation. The rotation of the motor will adjust the blades toward a fine or coarse pitch as required. The pilot can set a two-way switch to either manual or automatic operation.

CONFIRMATION OF TEACHING POINT 2

QUESTIONS:

- Q1. Who sets the blade angle on fixed pitch propeller?
- Q2. How can the propeller pitch be adjusted?
- Q3. What happens to the propeller if oil pressure is lost on a single-engine aircraft?

ANTICIPATED ANSWERS:

- A1. The blade angle is set by the manufacturer.
- A2. The mechanism for adjusting the pitch of the propeller includes:
 - mechanical,
 - hydraulic, and
 - electrical.
- A3. If oil pressure is lost during flight, the propeller will automatically go into fine pitch position, enabling the engine to develop the most power it can and achieve the best performance under the circumstances.

Teaching Point 3**Describe feathering and propeller reversing.**

Time: 5 min

Method: Interactive Lecture

Feathering is used on multi-engine aircraft. When one engine is off, the propeller is feathered meaning the turning blades are the extreme coarse pitch position and stop turning. This reduces drag on the blades, possible damage to the defective engine and stops excessive vibration.

Propeller reversing is used at slow speed to assist with stopping an aircraft once on the ground. The blade angle of a controllable pitch propeller is changed to a negative value. The reverse pitch uses engine power to produce a high negative thrust at slow speed.



A pilot of a multi-engine aircraft can decrease the radius of a turn by using propeller reversing with the inside engine.

CONFIRMATION OF TEACHING POINT 3**QUESTIONS:**

- Q1. What is feathering?
- Q2. For what is propeller reversing used?
- Q3. What pitch angle is used during propeller reversing?

ANTICIPATED ANSWERS:

- A1. Feathering is when blades are set to the extreme coarse pitch position and stop turning.
- A2. Propeller reversing is used at slow speed to assist with stopping an aircraft once on the ground.
- A3. A negative pitch angle is used during propeller reversing.

END OF LESSON CONFIRMATION**QUESTIONS:**

- Q1. What is pitch?
- Q2. Name two propeller types.
- Q3. What type of aircraft use propeller feathering?

ANTICIPATED ANSWERS:

- A1. Pitch is the distance in feet a propeller travels forward in one revolution.
- A2. Fixed pitch and variable pitch.
- A3. Multi-engine aircraft.

CONCLUSION

HOMEWORK / READING / PRACTICE

Nil.

METHOD OF EVALUATION

This EO is assessed IAW A-CR-CCP-804/PG-001, *Proficiency Level Four Qualification Standard and Plan*, Chapter 3, Annex B, Aviation Subjects–Combined Assessment PC.

CLOSING STATEMENT

Being able to describe propeller systems is important for understanding more complex material. A solid understanding of propellers is required to pursue future aviation training.

INSTRUCTOR NOTES / REMARKS

Nil.

REFERENCES

C3-116 ISBN 0-9680390-5-7 MacDonald, A. F., & Pepler, I. L. (2000). *From the ground up: Millennium edition*. Ottawa, ON: Aviation Publishers Co. Limited.

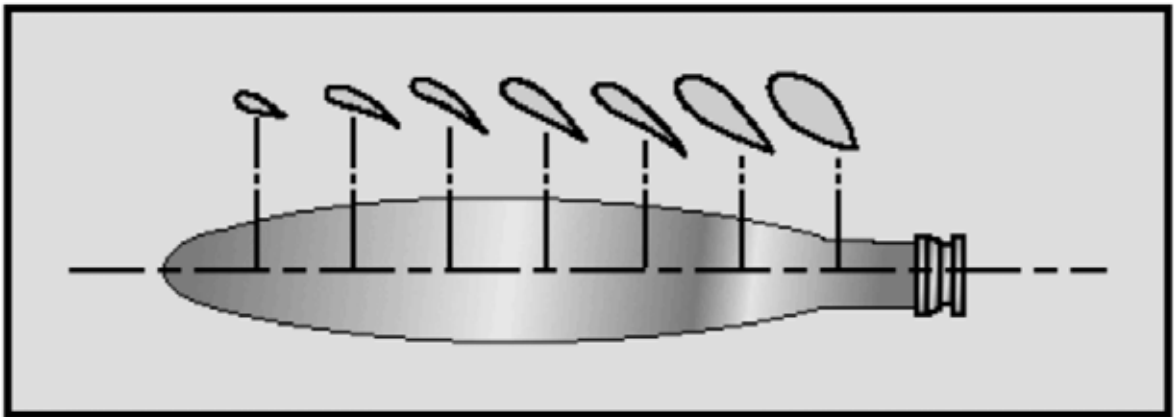

Figure A-1 Propeller Blade Shape

Note. From "Online Free Private Pilot Ground School", *The Aircraft Powerplant*. Retrieved November 27, 2008, from <http://www.free-online-private-pilot-ground-school.com/aircraft-powerplant.html>

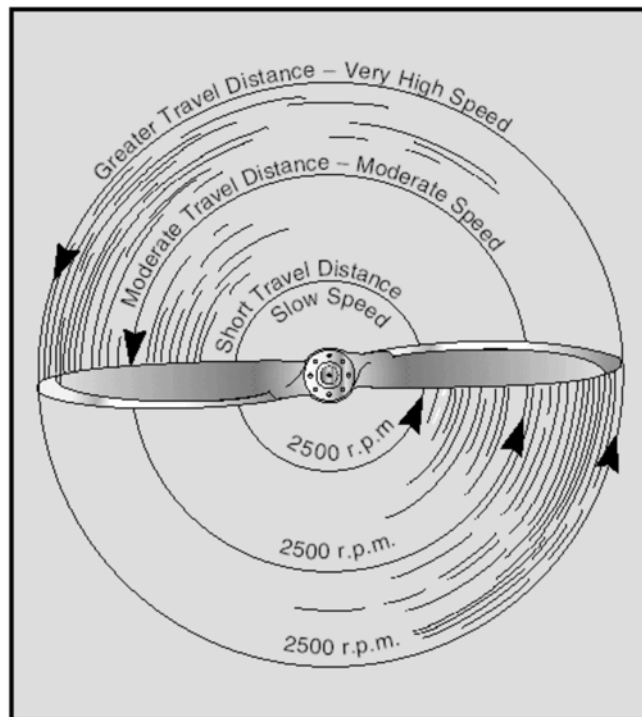

Figure A-2 Relationship of Travel Distance and Speed of Various Portions of Propeller Blade

Note. From "Online Free Private Pilot Ground School", *The Aircraft Powerplant*. Retrieved November 27, 2008, from <http://www.free-online-private-pilot-ground-school.com/aircraft-powerplant.html>

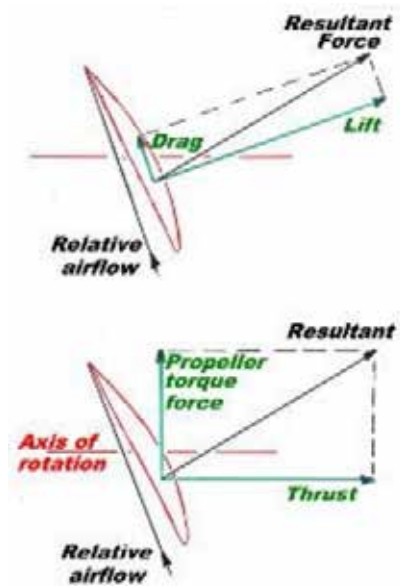

Figure A-3 Forces Acting on a Propeller Blade

Note. From "Recreational Aviation Australia Incorporated", *Engine and Propeller Performance*. Retrieved March 12, 2009, from <http://www.auf.asn.au/groundschool/propeller.html>



**ROYAL CANADIAN AIR CADETS
PROFICIENCY LEVEL FOUR
INSTRUCTIONAL GUIDE**



SECTION 3

EO M432.03 – DESCRIBE ENGINE INSTRUMENTS

Total Time:	30 min
-------------	--------

PREPARATION

PRE-LESSON INSTRUCTIONS

Resources needed for the delivery of this lesson are listed in the lesson specification located in A-CR-CCP-804/PG-001, *Proficiency Level Four Qualification Standard and Plan*, Chapter 4. Specific uses for said resources are identified throughout the instructional guide within the TP for which they are required.

Review the lesson content and become familiar with the material prior to delivering the lesson.

Prepare slides located at Attachment A.

Photocopy the Aero Engines Review Worksheet located at Attachment B for each cadet.

PRE-LESSON ASSIGNMENT

Nil.

APPROACH

An interactive lecture was chosen for TPs 1–4 to clarify, emphasize, and summarize engine instruments.

An in-class activity was chosen for TP 5 as it is an interactive way to reinforce the topic and confirm the cadets' comprehension of aero engine systems.

INTRODUCTION

REVIEW

Nil.

OBJECTIVES

By the end of this lesson the cadet shall have described engine instruments.

IMPORTANCE

It is important for cadets to be able to describe engine instruments as a solid understanding of engine instruments provides knowledge for potential instructional duties and is part of the fundamentals that cadets pursuing future aviation training will require.

Teaching Point 1**Describe the oil pressure and oil temperature gauges.**

Time: 5 min

Method: Interactive Lecture



Show slide of Figure A-1 to the cadets.

One of the principle engine instruments is the oil pressure gauge. It is usually positioned beside the oil temperature and fuel gauges. The instrument is calibrated in pounds per square inch (psi) and indicates the oil pressure supplied by the oil pump to lubricate the engine.

The gauge should be checked immediately after the engine has been started. As the oil warms, the reading should adjust to operational pressure. This may take up to 15 minutes. If the pressure remains high, the engine is not getting proper lubrication. High oil pressure pushes oil into the combustion chamber where it burns causing a smoky exhaust and badly carbonized piston heads, valve seats, cylinder heads and more.

Low oil pressure causes more serious problems as no film of oil goes between the working surfaces of the engine. Metal against metal rubbing causes main bearings to wear out.

The oil temperature gauge records the temperature of the oil in degrees Fahrenheit or Celsius. As the oil warms during start-up, the pressure should read high and the temperature low. Both instruments should approach their normal readings as the oil warms.



An abnormal drop in oil pressure and rise in oil temperature indicates trouble. Also, no change in oil pressure but a change in oil temperature is a warning of excessive friction or overload in the engine.

CONFIRMATION OF TEACHING POINT 1**QUESTIONS:**

- Q1. Which two gauges measure the properties of the engine oil?
- Q2. When should the oil pressure gauge be first checked?
- Q3. What changes in oil pressure and temperature indicates trouble?

ANTICIPATED ANSWERS:

- A1. Oil pressure and temperature gauges.
- A2. Immediately after the engine has been started.
- A3. An abnormal drop in oil pressure and rise in oil temperature.

Teaching Point 2**Describe the cylinder head temperature gauge.**

Time: 5 min

Method: Interactive Lecture



Show slide of Figure A-2 to the cadets.

The cylinder head temperature gauge shows the temperature of one or all engine cylinder heads. This reading shows the pilot the effectiveness of the engine cooling system. Extremely high cylinder head temperatures indicate an immediate sign of engine overload which can result in detonation, pre-ignition, and eventual engine failure.



Detonation. Abnormally rapid combustion due to the inability of fuel to burn slowly. Detonation is dangerous and expensive, causing high stress on engine parts and overheating.

Pre-ignition. The premature ignition of the mixture due to glowing carbon particles. It is sometimes confused with detonation. Pre-ignition is often experienced when attempting to start a hot engine and results in a backfire.

CONFIRMATION OF TEACHING POINT 2**QUESTIONS:**

- Q1. Which gauge measures the effectiveness of the engine cooling system?
- Q2. What do extremely high cylinder head temperatures indicate?
- Q3. In what can engine overload result?

ANTICIPATED ANSWERS:

- A1. The cylinder head temperature gauge.
- A2. An immediate engine overload.
- A3. Detonation, pre-ignition and eventual engine failure.

Teaching Point 3**Describe the tachometer.**

Time: 5 min

Method: Interactive Lecture



Show slide of Figure A-3 to the cadets.

The tachometer shows the speed at which the engine crankshaft is turning in hundreds of revolutions per minute (rpm). The tachometer records the engine hours of operation. The more common types of tachometer, are mechanical including centrifugal, or magnetic and electrical, which include direct current, or alternating current.

An aircraft with a fixed pitch propeller will only have a tachometer to read the engine power produced. It records the rpm at which the engine cranks and the propeller turns.

An aircraft with a controllable pitch or a constant speed propeller uses two gauges. The tachometer shows the rpm settings as controlled by the propeller control. The manifold pressure gauge shows the power produced by the engine.

The tachometer is marked with colour-coded arcs to indicate the proper range of engine operation, including:

- green indicating normal range of operation;
- yellow indicating the caution range and possible problems; and
- red indicating the maximum limit.

CONFIRMATION OF TEACHING POINT 3

QUESTIONS:

- Q1. What does the tachometer show?
- Q2. How is the tachometer marked?
- Q3. Which colours are used to indicate the proper range of engine operation?

ANTICIPATED ANSWERS:

- A1. The speed at which the engine crankshaft is turning.
- A2. With colour-coded arcs.
- A3. Green (normal range), yellow (caution range), and red (maximum limit).

Teaching Point 4

Describe the manifold pressure gauge.

Time: 5 min

Method: Interactive Lecture



Show slide of Figure A-4 to the cadets.

The manifold pressure gauge also has colour-coded arcs displayed on the gauge to indicate the normal operating range and operation limits. The gauge indicates in inches of mercury the fuel / air pressure in the engine intake manifold at the point between the carburetor and the cylinders.

With an aircraft fitted with a constant speed propeller, the rpm setting will remain constant. The manifold pressure gauge is the only instrument to show any fluctuations in the engine power output. A reduction in manifold pressure can indicate carburetor icing.

When the engine is not running, the reading on the manifold pressure gauge will be of the existing atmospheric pressure.

Excessive manifold pressure raises the compression pressure causing high stress on the pistons and cylinder assemblies. It also produces excessive temperature which may cause scoring on the pistons, sticking rings, and burned out valves.



When increasing power, increase the rpm first and then the manifold pressure.

When decreasing power, decrease the manifold pressure first and then the rpm.

CONFIRMATION OF TEACHING POINT 4

QUESTIONS:

- Q1. What does the manifold pressure gauge indicate?
- Q2. What can a reduction in manifold pressure indicate?
- Q3. What will the reading on the manifold pressure gauge be when the engine is not running?

ANTICIPATED ANSWERS:

- A1. The gauge indicates in inches of mercury the fuel / air pressure in the engine intake manifold at the point between the carburetor and the cylinders.
- A2. Carburetor icing.
- A3. The existing atmospheric pressure.

Teaching Point 5

Conduct an in-class activity to review aero engines.

Time: 5 min

Method: In-Class Activity

OBJECTIVE

The objective of this activity is to have the cadets review aero engine systems.

RESOURCES

- Pen / pencil,
- Aero Engines Review Worksheet located at Attachment B, and
- Aero Engines Review Worksheet Answer Key located at Attachment C.

ACTIVITY LAYOUT

Nil.

ACTIVITY INSTRUCTIONS

1. Distribute a worksheet to each cadet.
2. Have the cadets complete the worksheet.
3. When the cadets have completed their worksheet, have them review their answers using the answer key located at Attachment C.

SAFETY

Nil.

CONFIRMATION OF TEACHING POINT 5

The cadets' participation in the activity will serve as the confirmation of this TP.

END OF LESSON CONFIRMATION

The cadets' completion of the Aero Engines Review Worksheet will serve as the confirmation of this lesson.

CONCLUSION

HOMEWORK / READING / PRACTICE

Additional time may be required for the cadets to complete the worksheet.

METHOD OF EVALUATION

This EO is assessed IAW A-CR-CCP-804/PG-001, *Proficiency Level Four Qualification Standard and Plan*, Chapter 3, Annex B, Aviation Subjects–Combined Assessment PC.

CLOSING STATEMENT

Being able to describe engine instruments is important for understanding more complex material. A solid understanding of engine instruments is required to pursue future aviation training.

INSTRUCTOR NOTES / REMARKS

Nil.

REFERENCES

C3-116 ISBN 0-9680390-5-7 MacDonald, A. F., & Pepler, I. L. (2000). *From the ground up: Millennium edition*. Ottawa, ON: Aviation Publishers Co. Limited.



Oil Pressure Gauge



Oil Temperature Gauge

Figure A-1 Oil Pressure and Temperature Gauges

Note. From *From the Ground Up* (p. 133), by A. F. MacDonald and I. L. Pepper, 2000, Ottawa, ON: Aviation Publishers Co. Limited. Copyright 2000 by Aviation Publishers Co. Limited.

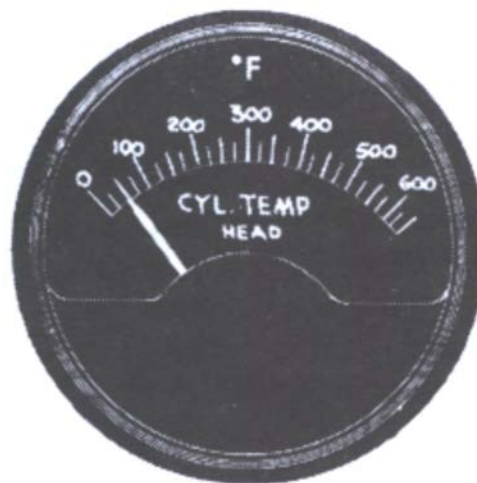

Figure A-2 Cylinder Head Temperature Gauge

Note. From *From the Ground Up* (p. 133), by A. F. MacDonald and I. L. Pepper, 2000, Ottawa, ON: Aviation Publishers Co. Limited. Copyright 2000 by Aviation Publishers Co. Limited.

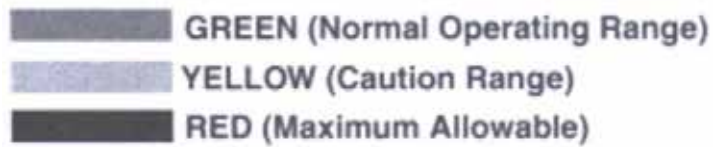

Figure A-3 Tachometer

Note. From *From the Ground Up* (p. 133), by A. F. MacDonald and I. L. Pepper, 2000, Ottawa, ON: Aviation Publishers Co. Limited. Copyright 2000 by Aviation Publishers Co. Limited.



Figure A-4 Manifold Pressure Gauge

Note. From *From the Ground Up* (p. 133), by A. F. MacDonald and I. L. Pepper, 2000, Ottawa, ON: Aviation Publishers Co. Limited. Copyright 2000 by Aviation Publishers Co. Limited.

Aero Engines Review Worksheet

1. Where should the fuel tank be positioned in a gravity feed system?
_____.
2. What system do low-wing configured aircraft and large aircraft with a large volume of fuel use?
_____.
3. What does the fuel selector valve, used by the pilot, do?
_____.
4. A rich mixture is used for:
_____.
5. How are the fuel / air proportions calculated?
_____.
6. Which propeller would not be good for taking off and climbing?
_____.
7. What is maintained throughout most of the diameter of the propeller by means of the variation in airfoil sections and the angle of attack?
_____.
8. What is the distance a propeller travels forward in one revolution?
_____.
9. What colour-coded arcs are found on the tachometer?
_____.
10. What reading will register on the manifold pressure gauge when the engine is not running?
_____.
11. What occurs to an engine as the altitude increases and the air becomes less?
_____.
12. A feathered propeller is in:
_____.
13. In what units is the oil pressure gauge calibrated?
_____.
14. What does the tachometer show?
_____.

15. Label the following parts on the diagram below.

- a. Thrust
- b. Relative airflow
- c. Propeller
- d. Axis of rotation
- e. Propeller torque force

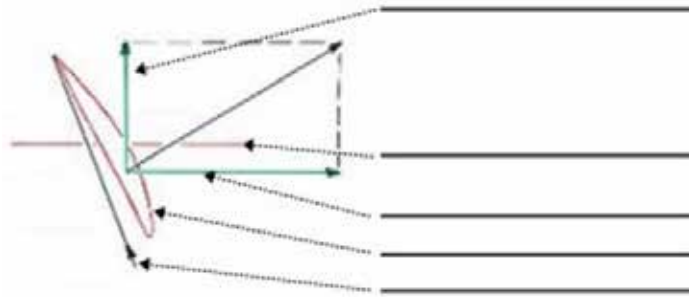

Aero Engines Review Worksheet Answer Key

1. Where should the fuel tank be positioned in a gravity feed system?
Above the carburetor.
2. What system do low-wing configured aircraft and large aircraft with a large volume of fuel use?
Pressure-feed system.
3. What does the fuel selector valve, used by the pilot, do?
Select desired fuel tank to draw fuel and shut off the flow of fuel from the tanks.
4. A rich mixture is used for:
high power settings.
5. How are the fuel / air proportions calculated?
By volume.
6. Which propeller would not be good for taking off and climbing?
Coarse pitch.
7. What is maintained throughout most of the diameter of the propeller by means of the variation in airfoil sections and the angle of attack?
Thrust.
8. What is the distance a propeller travels forward in one revolution?
Pitch.
9. What colour-coded arcs are found on the tachometer?
Green, yellow, red.
10. What reading will register on the manifold pressure gauge when the engine is not running?
Atmospheric pressure.
11. What occurs to an engine as the altitude increases and the air becomes less dense?
Power decreases.
12. A feathered propeller is in:
extreme coarse pitch position and stops turning.
13. In what units is the oil pressure gauge calibrated?
Pounds per square inch.
14. What does the tachometer show?
The speed at which the engine crankshaft is turning.

15. Label the following parts on the diagram below.
- a. Thrust
 - b. Relative airflow
 - c. Propeller
 - d. Axis of rotation
 - e. Propeller torque force

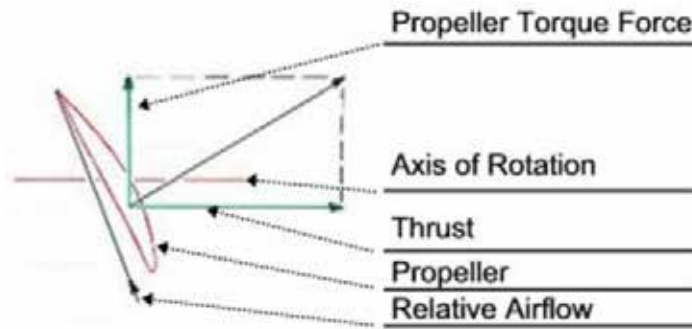



**ROYAL CANADIAN AIR CADETS
PROFICIENCY LEVEL FOUR
INSTRUCTIONAL GUIDE**



SECTION 4

EO C432.01 – DESCRIBE IGNITION AND ELECTRICAL SYSTEMS

Total Time:	30 min
-------------	--------

PREPARATION

PRE-LESSON INSTRUCTIONS

Resources needed for the delivery of this lesson are listed in the lesson specification located in A-CR-CCP-804/PG-001, *Proficiency Level Four Qualification Standard and Plan*, Chapter 4. Specific uses for said resources are identified throughout the instructional guide within the TP for which they are required.

Review the lesson content and become familiar with the material prior to delivering the lesson.

Prepare slides located at Attachment A.

PRE-LESSON ASSIGNMENT

Nil.

APPROACH

An interactive lecture was chosen for this lesson to clarify, emphasize, and summarize the ignition and electrical systems.

INTRODUCTION

REVIEW

Nil.

OBJECTIVES

By the end of this lesson the cadet shall have described ignition and electrical systems.

IMPORTANCE

It is important for cadets to be able to describe ignition and electrical systems as a solid understanding of ignition and electrical systems provides knowledge for potential instructional duties and is part of the fundamentals that cadets pursuing future aviation training will require.

Teaching Point 1**Describe the ignition system.**

Time: 15 min

Method: Interactive Lecture



Show slide of Figure A-1 to the cadets.

The ignition system provides an electrical spark to ignite the fuel / air mixture in each cylinder. The system usually consists of:

- two magnetos,
- two spark plugs per cylinder,
- ignition leads, and
- a magneto switch (on the instrument panel).

The magneto is an engine-driven generator which produces an electrical current without using an external current. It combines all elements of the ignition system, including:

- generating a low tension current;
- transforming the low tension current to high tension; and
- distributing the current to the individual spark plugs and causing them to fire.

When the magneto switch is off, the system is grounded and the electrical charge does not flow through the magneto and a spark is not produced. When the switch is on, the system is not grounded and the electrical charge flows through the magneto and a spark can be produced.

Dual ignition systems include two spark plugs in each cylinder, and two magnetos.

One spark plug in each cylinder is fired by one magneto. The other magneto fires the second spark plug in each cylinder. This dual ignition system provides improved:

- **Safety.** If one system fails, the engine will still operate.
- **Performance.** Improved combustion of the fuel / air mixture increases the power output and gives better engine performance.

The magneto switch allows the pilot to select either one or both magneto systems. The engine should always be operated on both magneto systems during takeoff and normal flight.



The magneto switch shall be turned to off when the aircraft is parked. If the propeller is moved, the engine can fire if the ignition switch is on.

Correctly set ignition timing allows the magneto to fire at the right time. If the spark plug fires too early, poor engine performance may occur, including:

- loss of power, and
- overheating which can lead to:
 - detonation,
 - pre-ignition,
 - piston burning,
 - scored cylinders, and
 - broken rings.

The wires in the ignition system are shielded (a metal covering which is grounded). Shielding prevents the ignition current from interfering with the radio, whole ignition system, magnetos, plugs, and wiring.

CONFIRMATION OF TEACHING POINT 1

QUESTIONS:

- Q1. What are the parts of the ignition system?
- Q2. What does correct set ignition timing allow?
- Q3. What does shielding prevent?

ANTICIPATED ANSWERS:

- A1. The ignition system has:
- two magnetos,
 - two spark plugs per cylinder,
 - ignition leads, and
 - a magneto switch (on the instrument panel).
- A2. Allows the magneto to fire at the right time.
- A3. The ignition current from interfering with the radio, whole ignition system, magnetos, plugs, and wiring.

Teaching Point 2

Describe the electrical system.

Time: 10 min

Method: Interactive Lecture



Show slide of Figure A-2 to the cadets.

The electrical system includes everything that operates electrically except the magnetos. There is no connection from the aircraft's electrical system to the ignition system.

The basic electrical system includes:

- a storage battery,
- master switch and battery solenoid,
- starter motor and solenoid,
- generator (or alternator),
- voltage regulator,
- bus bar, and
- circuit breakers.

The electrical system is either a 12- or 24-volt system and is direct current. The battery solenoid activated by the master switch completes the circuit between the electrical energy from the storage battery and the electrical system. The most important action by a pilot is to have the battery fully charged for the electrical components to function satisfactorily.

The starter switch activates the starter solenoid which allows current to enter and drive the starter motor.

The engine drives the generator or alternator for the purpose of providing current to the electrical system, and recharging the battery.



An alternator produces sufficient current to operate the various electrical components at low engine speeds.

A generator will not begin to supply current until the engine is turning at a faster speed.

The voltage regulator is used to prevent the generator or alternator from overloading the system, and the battery from becoming overcharged.

The current produced by the generator or alternator and battery is received by the bus bar which passes the current through the various circuit breakers and branches out to the various electrical circuits.

Circuit breakers or other fuses protect all electrical circuits from damage from excess voltage or current, and short-circuits. Most circuit breakers have a push button to reset. If the circuit breaker continues to fail, there may be malfunction in the component that could cause an electrical fire.

The pilot monitors the electrical system in the cockpit using:

- an ammeter,
- a voltmeter, and / or
- a warning light.

The ammeter measures in amperes the rate of flow of the electrical current being produced and when power is being used by the battery.

The voltmeter indicates the voltage in the electrical system.

The generator warning light shows when the generator is not working.



If the ammeter is showing on the plus (+) side of 0 on the gauge, there is satisfactory electrical operation.

If the ammeter is showing discharge or minus (-), energy is drawing from the battery rather than from the generator / alternator.

All contacts between the battery, voltage regulator, and the alternator or generator need to be clean and secure. Battery water level should be checked regularly and an aged battery that is no longer working properly should immediately be replaced.

CONFIRMATION OF TEACHING POINT 2

QUESTIONS:

- Q1. What is the most important action by a pilot regarding the electrical system?
- Q2. What instruments does the pilot monitor?
- Q3. What do all the contacts between the battery, voltage regulator, and the alternator or generator need to be?

ANTICIPATED ANSWERS:

- A1. Ensure the battery is fully charged.
- A2. An ammeter, a voltmeter, and / or a warning light.
- A3. To be clean and secure.

END OF LESSON CONFIRMATION

QUESTIONS:

- Q1. What is the difference between an alternator and a generator?
- Q2. What shall the magneto switch be turned to when the aircraft is parked?
- Q3. What is included in the basic electrical system?

ANTICIPATED ANSWERS:

- A1. An alternator produces sufficient current to operate the various electrical components at low engine speeds while a generator will not begin to supply current until the engine is turning at a faster speed.
- A2. The magneto switch shall be turned to off when the aircraft is parked.
- A3. The basic system includes:
- a storage battery,
 - master switch and battery solenoid,
 - starter motor and solenoid,
 - generator (or alternator),
 - voltage regulator,

- bus bar, and
- circuit breakers.

CONCLUSION

HOMEWORK / READING / PRACTICE

Nil.

METHOD OF EVALUATION

Nil.

CLOSING STATEMENT

Being able to describe ignition and electrical systems is important for understanding more complex material. A solid understanding of ignition and electrical systems is required to pursue future aviation training.

INSTRUCTOR NOTES / REMARKS

Cadets who are qualified Advanced Aviation may assist with this instruction.

REFERENCES

C3-116 ISBN 0-9680390-5-7 MacDonald, A. F., & Peppler, I. L. (2000). *From the ground up: Millennium edition*. Ottawa, ON: Aviation Publishers Co. Limited.

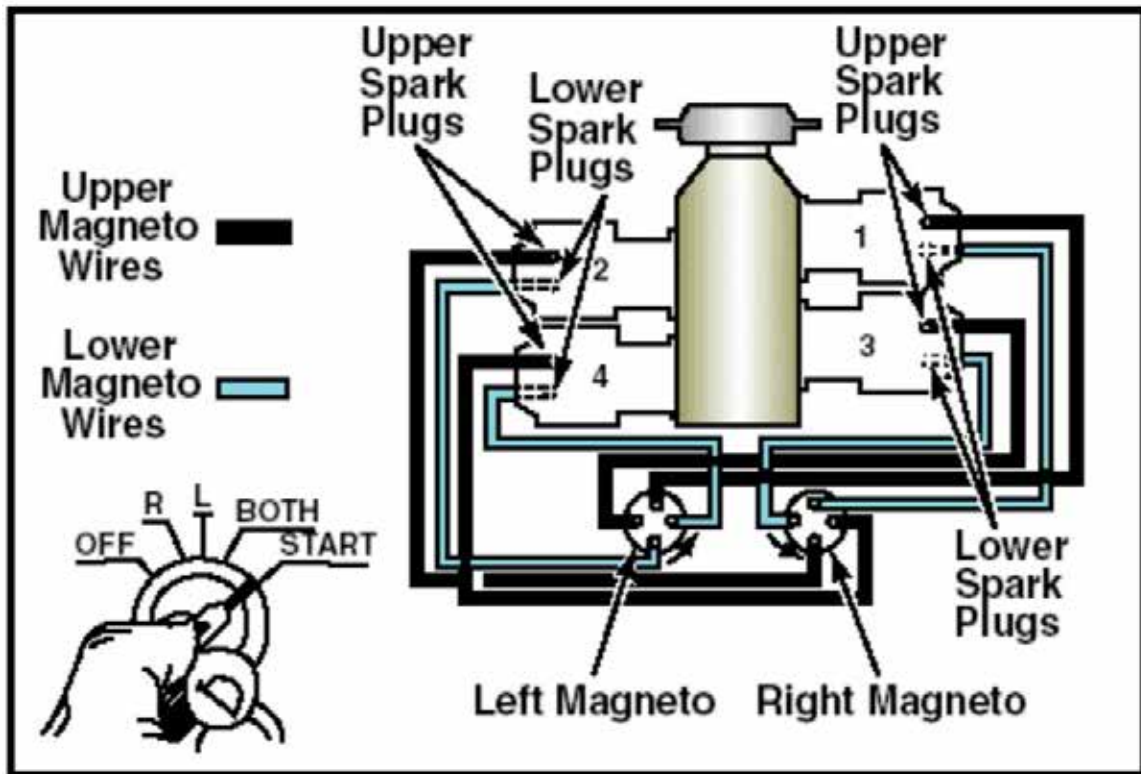

Figure A-1 Ignition System

Note. From "Online Free Private Pilot Ground School", *The Aircraft Powerplant*. Retrieved March 13, 2009, from <http://www.free-online-private-pilot-ground-school.com/aircraft-powerplant.html>

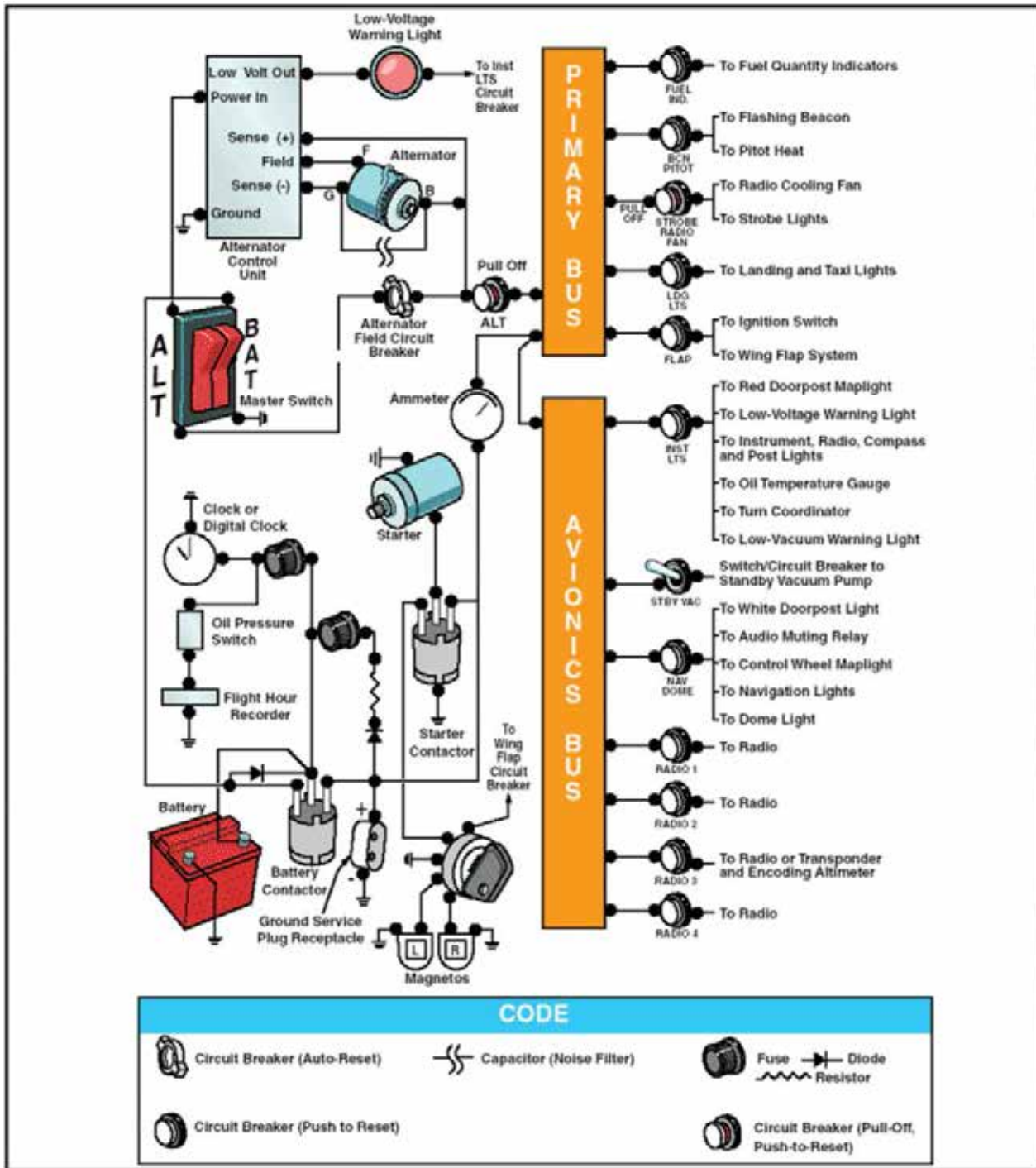

Figure A-2 Electrical System

Note. From "Online Free Private Pilot Ground School", *The Aircraft Powerplant*. Retrieved March 13, 2009, from <http://www.free-online-private-pilot-ground-school.com/aircraft-powerplant.html>



**ROYAL CANADIAN AIR CADETS
PROFICIENCY LEVEL FOUR
INSTRUCTIONAL GUIDE**



SECTION 5

EO C432.02 – DESCRIBE TURBOCHARGING AND SUPERCHARGING SYSTEMS

Total Time:	30 min
-------------	--------

PREPARATION

PRE-LESSON INSTRUCTIONS

Resources needed for the delivery of this lesson are listed in the lesson specification located in A-CR-CCP-804/PG-001, *Proficiency Level Four Qualification Standard and Plan*, Chapter 4. Specific uses for said resources are identified throughout the instructional guide within the TP for which they are required.

Review the lesson content and become familiar with the material prior to delivering the lesson.

Prepare slides located at Attachment A.

Photocopy the Turbocharging and Supercharging Worksheet located at Attachment B for each cadet.

PRE-LESSON ASSIGNMENT

Nil.

APPROACH

An interactive lecture was chosen for TPs 1 and 2 to clarify, emphasize, and summarize turbocharging and supercharging systems.

An in-class activity was chosen for TP 3 to confirm the cadets' comprehension of turbocharging and supercharging.

INTRODUCTION

REVIEW

Nil.

OBJECTIVES

By the end of this lesson the cadet shall have described turbocharging and supercharging systems.

IMPORTANCE

It is important for cadets to be able to describe turbocharging and supercharging systems as a solid understanding of turbocharging and supercharging systems provides knowledge for potential instructional duties and is part of the fundamentals that cadets pursuing future aviation training will require.

Teaching Point 1**Describe turbocharging.**

Time: 10 min

Method: Interactive Lecture



Show slide of Figure A-1 to the cadets.

The capability of the engine to produce power decreases as altitude increases and the air becomes less dense. A turbocharger supplies dense air when the aircraft is operating in thin air at a high altitude using the engine power without using engine horsepower.



Show slide of Figure A-2 to the cadets.

Hot exhaust gases are discharged as waste energy and directed through a turbine wheel (impeller) at high rpm. The turbine wheel is mounted on a shaft paired with a centrifugal air compressor enclosed in separate housings. The compressor turns at the same speed as the turbine wheel. The air supplied by the compressor will be denser which enables the engine to produce more power.

The turbocharger is located between the air intake and the carburetor so the air is compressed before mixing with the fuel from the carburetor. The speed of the turbine depends on the difference in pressure between the exhaust gas and the outside pressure. The greater the difference, the less back pressure on the escaping gases and more speed by the turbine.

When flying at lower, denser altitudes, a waste gate in the exhaust system can remain open and the exhaust gas vents around the turbine into the atmosphere. Control of the turbocharger is provided by manual control, and automatic control.

Manual control. The simplest control system. It involves bleeding exhaust gas continuously through an opening of predetermined size allowing the remainder of the exhaust gas to turn the turbocharger. Engine power is adjusted by the throttle.

The more common manual control connects the throttle and the waste gate with the cockpit throttle control. A programmed movement of the throttle plate in the carburetor and the waste gate pair the opening and closing of the two systems. As the throttle plate moves toward full open, the waste gate closes.

Automatic control. A pressure controller senses the difference in air pressure and controls the position of the waste gate using pressurized oil.

The turbocharging system increases performance at altitude. It delivers full power at altitudes above the service ceiling of a normal engine.

CONFIRMATION OF TEACHING POINT 1
QUESTIONS:

- Q1. What does a turbocharger supply?
- Q2. On what does the speed of the turbine depend?
- Q3. What does the pressure controller in an automatic control do when it senses a difference in air pressure?

ANTICIPATED ANSWERS:

- A1. Dense air when the aircraft is operating in thin air at a high altitude.
- A2. The difference in pressure between the exhaust gas and the outside pressure.
- A3. It controls the position of the waste gate using pressurized oil.

Teaching Point 2
Describe supercharging systems.

Time: 5 min

Method: Interactive Lecture



Show slide of Figure A-3 to the cadets.

Supercharging works on the same general principles as turbocharging (eg, density). The supercharger is an internally driven compressor powered by the engine. A supercharger compresses the fuel / air mixture after it leaves the carburetor (forced induction). When forced induction is used to increase the power of an engine at low altitudes, it is called boost.

When forced induction is used at high altitude to adjust for the lower density of the air and maintain sea level power, it is called supercharging.



Turbocharging. Compressing the intake air using a turbine turned by the exhaust gases.

Supercharging. Compressing the intake air using a turbine turned by the engine / crankshaft power.

CONFIRMATION OF TEACHING POINT 2
QUESTIONS:

- Q1. What powers the supercharger?
- Q2. What is the name given when the supercharger compresses the fuel / air mixture after it leaves the carburetor?
- Q3. What is supercharging?

ANTICIPATED ANSWERS:

- A1. The engine powers the supercharger.
- A2. Forced induction.
- A3. Supercharging is the use of forced induction at high altitude to adjust for the lower density of the air and maintain sea level power.

Teaching Point 3

Conduct an in-class activity to confirm the cadets' comprehension of turbocharging and supercharging.

Time: 10 min

Method: In-Class Activity

OBJECTIVE

The objective of this activity is to have the cadets confirm their comprehension of turbocharging and supercharging.

RESOURCES

- Pen / pencil,
- Turbocharging and Supercharging Worksheet located at Attachment B, and
- Turbocharging and Supercharging Worksheet Answer Key located at Attachment C.

ACTIVITY LAYOUT

Nil.

ACTIVITY INSTRUCTIONS

1. Distribute a worksheet to each cadet.
2. Have the cadets complete the worksheet.
3. Review the answers using the answer key.

SAFETY

Nil.

CONFIRMATION OF TEACHING POINT 3

The cadets' participation in the activity will serve as the confirmation of this TP.

END OF LESSON CONFIRMATION

The cadets' completion of the Turbocharging and Supercharging Worksheet will serve as the confirmation of this lesson.

CONCLUSION

HOMEWORK / READING / PRACTICE

Nil.

METHOD OF EVALUATION

Nil.

CLOSING STATEMENT

Being able to describe turbocharging and supercharging systems is important for understanding more complex material. A solid understanding of turbocharging and supercharging systems is required to pursue future aviation training.

INSTRUCTOR NOTES / REMARKS

Cadets who are qualified Advanced Aviation may assist with this instruction.

REFERENCES

C3-116 ISBN 0-9680390-5-7 MacDonald, A. F., & Pepler, I. L. (2000). *From the ground up: Millennium edition*. Ottawa, ON: Aviation Publishers Co. Limited.

THIS PAGE INTENTIONALLY LEFT BLANK

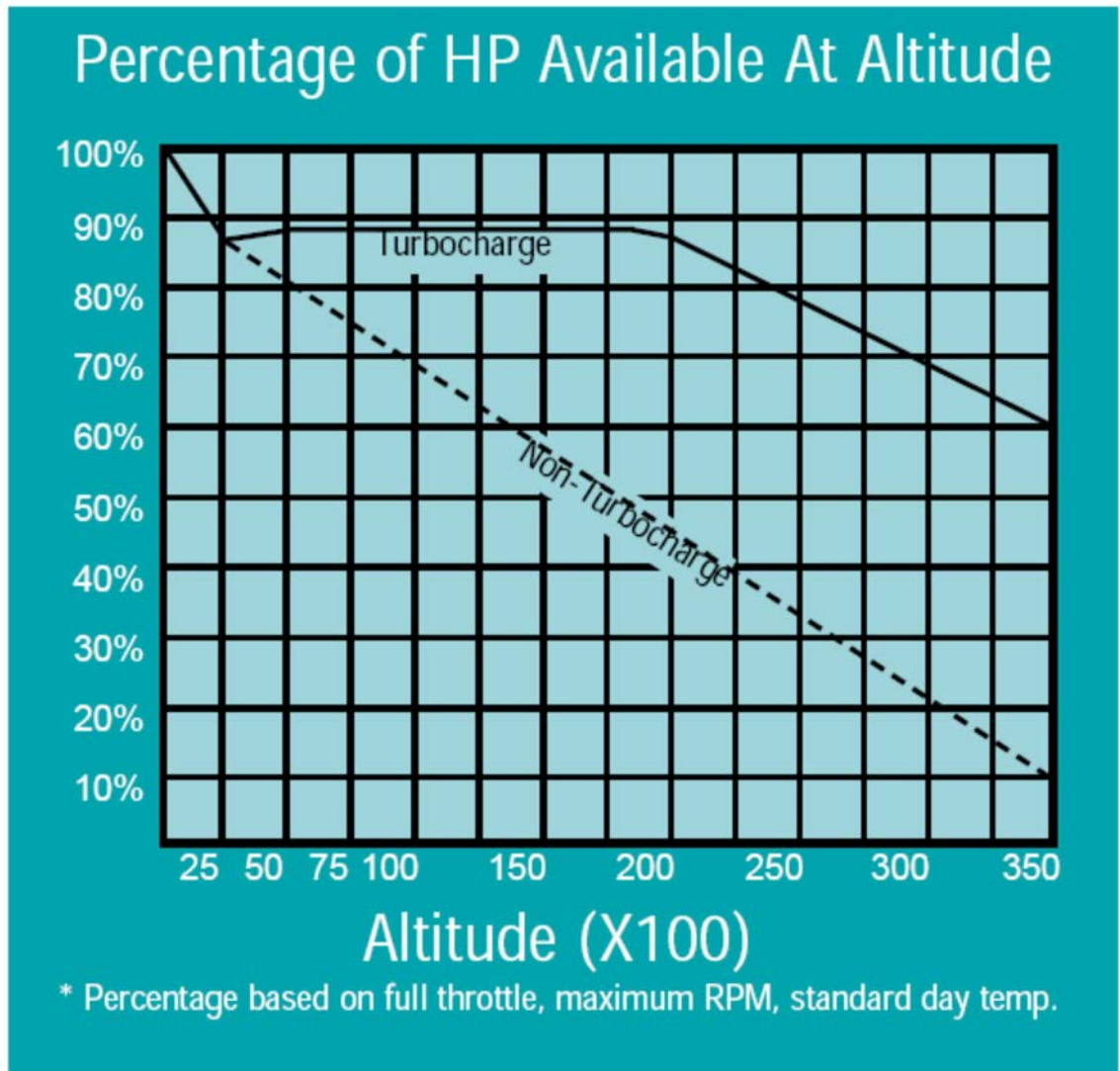

Figure A-1 Percentage of Horsepower Available at Altitude

Note. From "Boosting Your Knowledge of Turbocharging", *Kelly Aerospace*. Retrieved March 17, 2009, from <http://www.kellyaerospace.com/articles/Turbocharging.pdf>

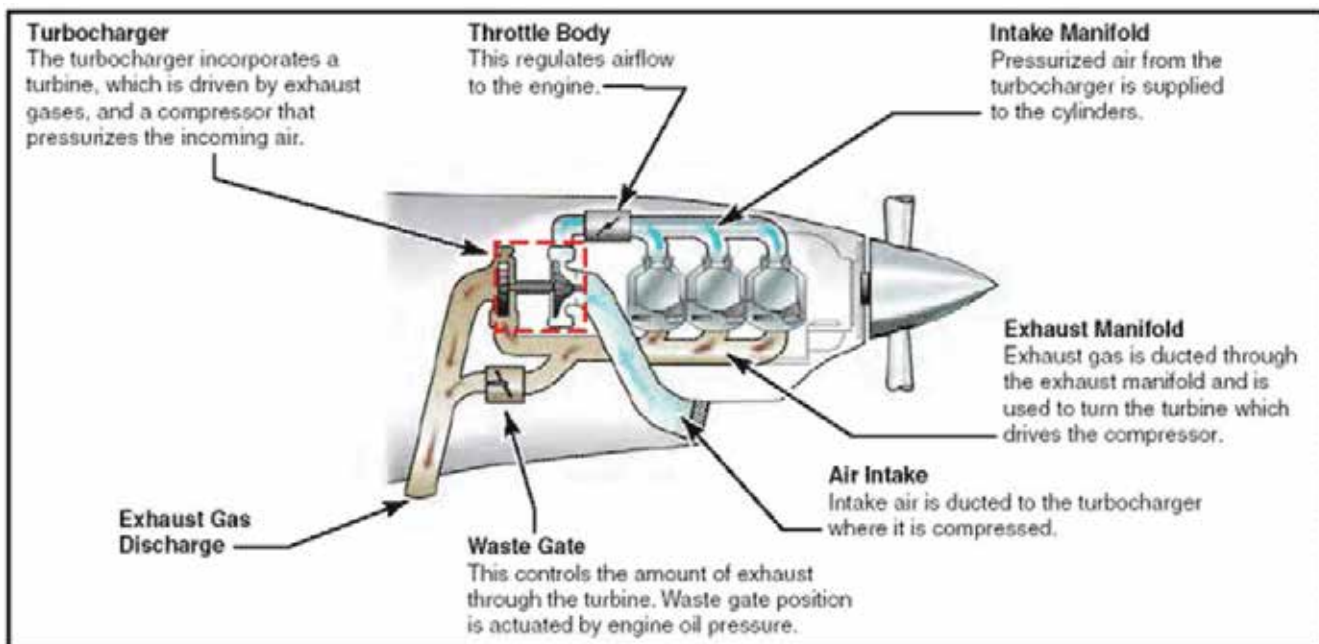

Figure A-2 Turbocharger Components

Note. From "Online Free Private Pilot Ground School", *The Aircraft Powerplant*. Retrieved March 17, 2009, from <http://www.free-online-private-pilot-ground-school.com/aircraft-powerplant.html>

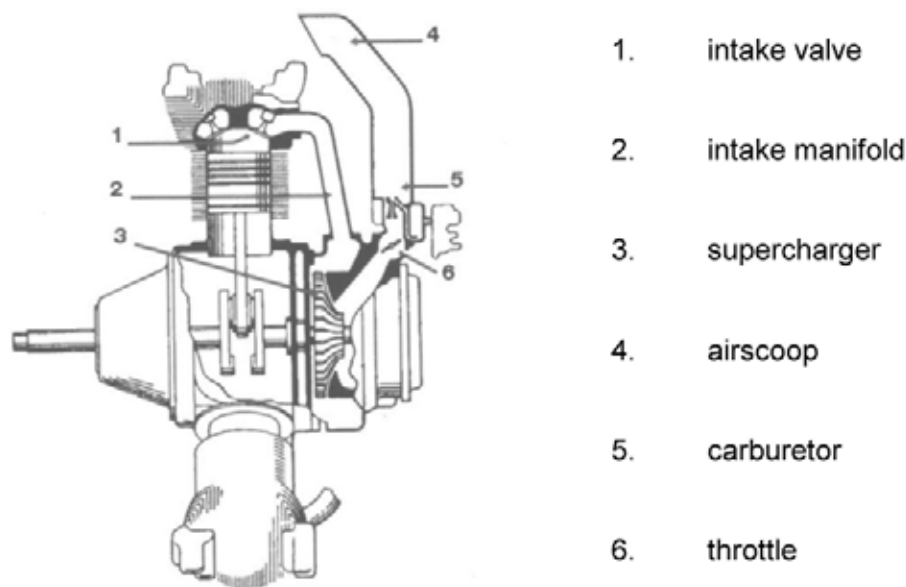

Figure A-3 Supercharger Components

Note. From *From the Ground Up: Millennium Edition* (p. 56), by A. F. MacDonald and I. L. Pepper, 2000, Ottawa, ON: Aviation Publishers Co. Limited. Copyright 2000 by Aviation Publishers Co. Limited.

Turbocharging and Supercharging Worksheet

1. Place the following labels in the correct location:
 - a. exhaust manifold,
 - b. air intake,
 - c. waste gate,
 - d. exhaust gas discharge,
 - e. turbocharger,
 - f. throttle body, and
 - g. intake manifold.

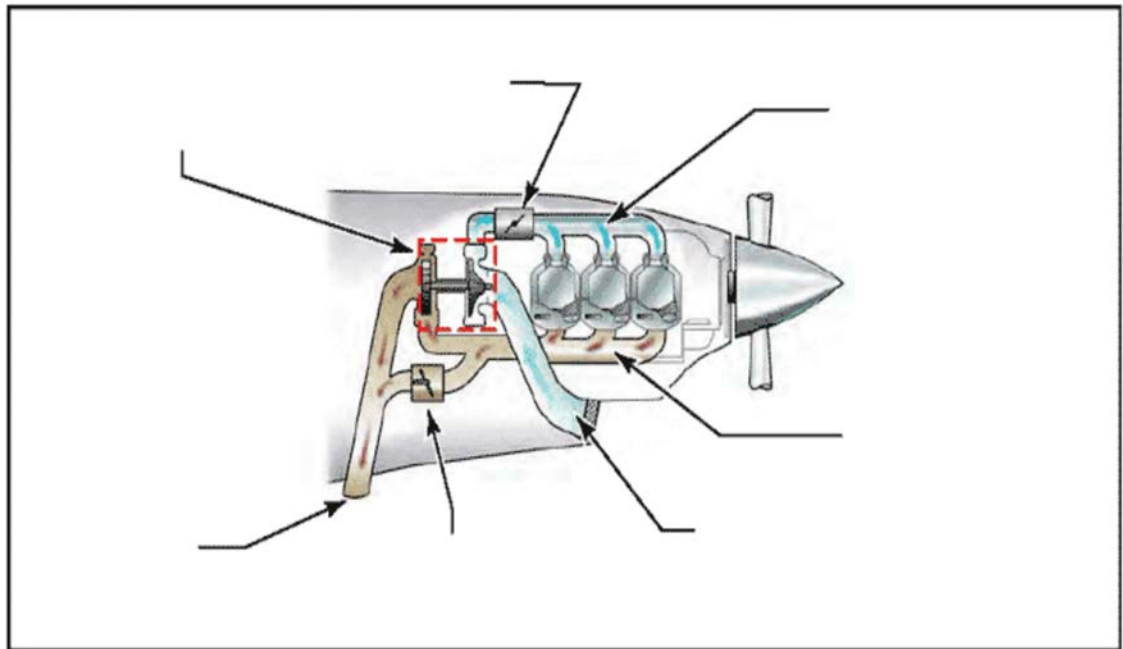

Figure B-1 Turbocharger Components

Note. From "Online Free Private Pilot Ground School", *The Aircraft Powerplant*. Retrieved March 17, 2009, from <http://www.free-online-private-pilot-ground-school.com/aircraft-powerplant.html>

2. Explain the key differences between turbocharging and supercharging.

3. Place the following labels in the correct location:

- a. supercharger,
- b. intake manifold,
- c. airscoop,
- d. intake valve,
- e. carburetor, and
- f. throttle.

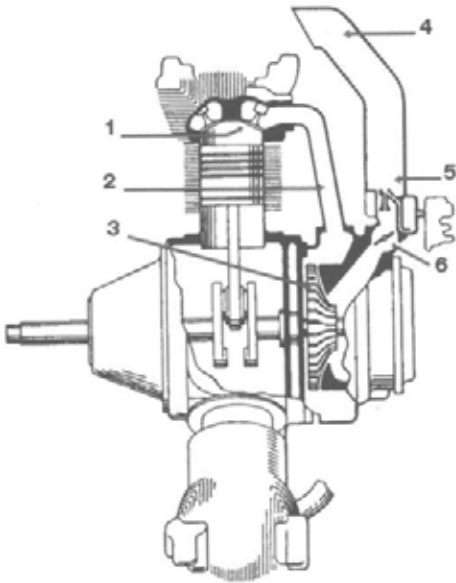

- 1. _____
- 2. _____
- 3. _____
- 4. _____
- 5. _____
- 6. _____

Figure B-2 Supercharger Components

Note. From *From the Ground Up: Millennium Edition* (p. 56), by A. F. MacDonald and I. L. Pepper, 2000, Ottawa, ON: Aviation Publishers Co. Limited. Copyright 2000 by Aviation Publishers Co. Limited.

Turbocharging and Supercharging Worksheet Answer Key

1. Place the following labels in the correct location:
 - a. exhaust manifold,
 - b. air intake,
 - c. waste gate,
 - d. exhaust gas discharge,
 - e. turbocharger,
 - f. throttle body, and
 - g. intake manifold.

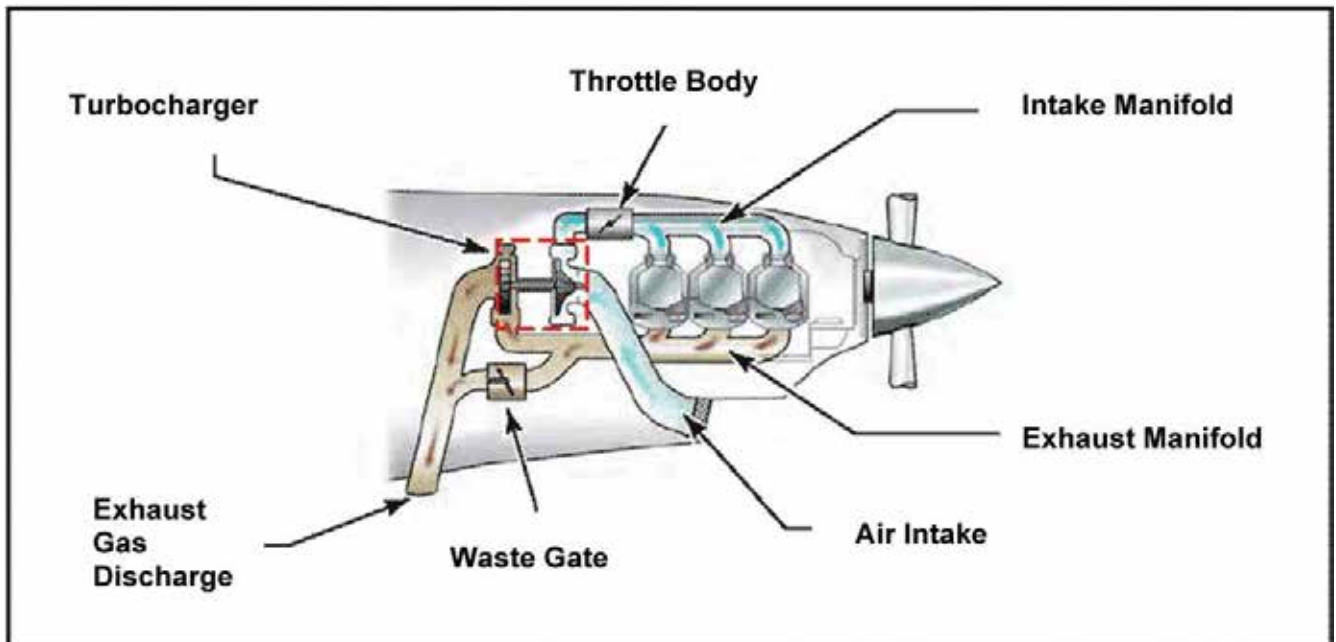

Figure C-1 Turbocharger Components

Note. From "Online Free Private Pilot Ground School", *The Aircraft Powerplant*. Retrieved March 17, 2009, from <http://www.free-online-private-pilot-ground-school.com/aircraft-powerplant.html>

2. Explain the key differences between turbocharging and supercharging.

A turbocharger compresses the intake air using a turbine turned by the exhaust gases.

A supercharger compresses the intake air using a turbine turned by the engine / crankshaft power.

3. Place the following labels in the correct location:

- a. supercharger,
- b. intake manifold,
- c. airscoop,
- d. intake valve,
- e. carburetor, and
- f. throttle.

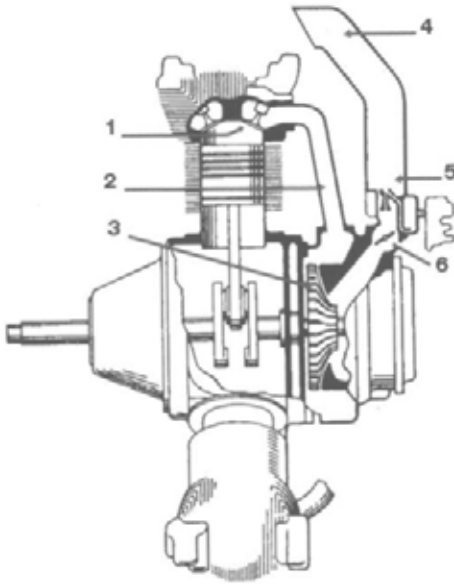

1. **intake valve**

2. **intake manifold**

3. **supercharger**

4. **airscoop**

5. **carburetor**

6. **throttle**

Figure C-2 Supercharger Components

Note. From *From the Ground Up: Millennium Edition* (p. 56), by A. F. MacDonald and I. L. Pepper, 2000, Ottawa, ON: Aviation Publishers Co. Limited. Copyright 2000 by Aviation Publishers Co. Limited.



**ROYAL CANADIAN AIR CADETS
PROFICIENCY LEVEL FOUR
INSTRUCTIONAL GUIDE**



SECTION 6

EO C432.03 – DESCRIBE GAS TURBINE ENGINES

Total Time:	30 min
-------------	--------

PREPARATION

PRE-LESSON INSTRUCTIONS

Resources needed for the delivery of this lesson are listed in the lesson specification located in A-CR-CCP-804/PG-001, *Proficiency Level Four Qualification Standard and Plan*, Chapter 4. Specific uses for said resources are identified throughout the instructional guide within the TP for which they are required.

Review the lesson content and become familiar with the material prior to delivering the lesson.

Prepare slides located at Attachment A.

PRE-LESSON ASSIGNMENT

Nil.

APPROACH

An interactive lecture was chosen for this lesson to clarify, emphasize, and summarize gas turbine engines.

INTRODUCTION

REVIEW

Nil.

OBJECTIVES

By the end of this lesson the cadet shall have described gas turbine engines.

IMPORTANCE

It is important for cadets to be able to describe gas turbine engines as a solid understanding of gas turbine engines provides knowledge for potential instructional duties and is part of the fundamentals that cadets pursuing future aviation training will require.

Teaching Point 1**Describe turbojets.**

Time: 10 min

Method: Interactive Lecture

TURBOJETS

Newton's third law states that for every action there is an equal and opposite reaction. All propulsion systems rely on this fact in some way. A turbojet engine is a reactive engine, which creates thrust by ejecting hot gases to create a force, as described by Newton's third law of motion.

The amount of thrust developed by ejecting hot gases depends on the mass and velocity of the material ejected. A turbojet generates thrust by imparting a relatively large acceleration to a relatively small mass of air.



Show the slide of Figure A-1 to the cadets.

Air is brought into the engine through the intake opening at the front and compressed by a series of compressor blades. Once compressed, fuel is added and the mixture is ignited. The hot gases created by the very rapidly burning fuel / air mixture are highly pressurized. These high pressure gases exit at a high velocity out of the back of the engine. Between the combustion chamber and the exhaust nozzle, the high pressure gases are used to turn a turbine that is connected to the compressor blades.



In a reciprocating engine (eg, radial, in-line, horizontally opposed), a new combustion process occurs during each stroke / cycle.

In a turbojet engine, the combustion process is continuous from the time the engine is started until the engine is shut down.

To start the engine, pressurized air is injected into the engine from either an on-board or ground-based source. Another way is to use an alternate power source to spin the compressor blades, drawing air into the engine. Once a sufficient volume of air is flowing into the combustion chamber, fuel and an ignition source can be added. Once combustion has started and the hot exhaust gases are spinning the turbine connected to the compressor blades, the engine is capable of drawing air into itself on its own, and the on-board or ground-based air / power source can be disconnected.



As an aircraft with a turbojet engine flies faster, more air is pushed into the engine as a result of the forward motion. This improves the fuel efficiency of the engine. A turbojet engine becomes more fuel efficient as the airspeed increases.

Conversely, turbojets become fuel inefficient at low airspeeds.

Turbojets can usually be identified visually by their external shape. Turbojets typically have a constant diameter from the front of the engine (air intake) to the rear of the engine (exhaust nozzle).

CONFIRMATION OF TEACHING POINT 1

QUESTIONS:

- Q1. Which law of motion does a turbojet engine demonstrate?
- Q2. What is different about the combustion in a turbojet engine, when compared to a reciprocating engine?
- Q3. What happens to the fuel efficiency of a turbojet engine as the airspeed increases?

ANTICIPATED ANSWERS:

- A1. A turbojet engine demonstrates Newton's third law of motion.
- A2. In a turbojet engine, the combustion process is continuous from the time the engine is started until the engine is shut down.
- A3. A turbojet engine becomes more fuel efficient as the airspeed increases.

Teaching Point 2

Describe turbofans.

Time: 10 min

Method: Interactive Lecture

TURBOFANS



Show the slide of Figure A-2 to the cadets.

The turbofan is a turbojet with a fan attached in front of the compressor blades. The fan diameter is larger than the engine core and some of the air moved by the fan bypasses the engine core. This air is moved backwards by the fan in the same way that a propeller works and creates additional thrust for the engine.

In a low-bypass turbofan, the amount of air that bypasses the engine and the amount of air that enters the engine core are approximately equal. In a high-bypass turbo fan, approximately four times as much air may bypass the engine core, which may result in up to 80 percent of the total thrust coming from the bypass portion of the engine.



Show the slide of Figure A-3 to the cadets.



Turbofans are more fuel efficient than turbojets, especially at lower airspeeds. They also produce less noise than turbojets. A turbofan produces more thrust than a turbojet of a similar physical size.

Turbofans can usually be identified visually by their external shape. Turbofans typically have an air intake that is two to four times the diameter of the exhaust nozzle.

Additional advantages of a turbofan engine include:

- very high power to weight ratio, compared to reciprocating and turbojet engines; and
- less vibration than a reciprocating engine.

Disadvantages of a turbofan engine include:

- high cost, and
- delayed response to changes in power settings.

CONFIRMATION OF TEACHING POINT 2

QUESTIONS:

- Q1. What is a turbofan engine?
- Q2. How much air may bypass the engine core in a high-bypass turbofan engine?
- Q3. What are two advantages of a turbofan engine?

ANTICIPATED ANSWERS:

- A1. A turbofan is a turbojet with a fan attached in front of the compressor blades.
- A2. In a high-bypass turbofan approximately four times as much air that enters the engine core may bypass the engine core.
- A3. Two advantages of a turbofan engine include:
- very high power to weight ratio, compared to reciprocating and turbojet engines; and
 - less vibration than a reciprocating engine.

Teaching Point 3

Describe turboprops and turboshafts.

Time: 5 min

Method: Interactive Lecture

Instead of using the power of the exhaust gases to produce thrust directly, the gases can be used to turn a turbine connected to a propeller or a shaft.

TURBOPROPS



Show the slide of Figure A-4 to the cadets.

When the power of the exhaust gases are used to turn a propeller, the engine is called a turboprop. In a fixed shaft turboprop, the same turbine turns both the compressor blades and the shaft connected to the propeller. In a free turbine turboprop, a separate turbine is used to turn the shaft connected to the propeller.



The PT6 turboprop engine, manufactured by Pratt and Whitney Aircraft of Canada, is one of the most popular turboprop engines in the world. It comes in a variety of power outputs and is used in a wide range of aircraft.



In all turboprop engines, the shaft from the turbine is connected to a gearbox to reduce the speed of the shaft to a range that is suitable for spinning the propeller.

TURBOSHAFTS

If the shaft of the gas turbine engine is connected to something other than a propeller, the engine is called a turboshaft. The shaft will be connected to a transmission system, and may be used to drive helicopter rotors, electrical generators, compressors, pumps, marine propulsion systems (eg, ships), and / or land propulsion systems (eg, tanks).

CONFIRMATION OF TEACHING POINT 3

QUESTIONS:

- Q1. What is the difference between a turboprop and a turboshaft engine?
- Q2. What is the shaft connected to in a turboprop engine to reduce the speed of the shaft?
- Q3. For what can a turboshaft engine be used?

ANTICIPATED ANSWERS:

- A1. In a turboprop engine, the shaft is connected to a propeller; in a turboshaft engine, it is connected to something other than a propeller.
- A2. In a turboprop engine, the shaft from the turbine is connected to a gearbox to reduce the speed of the shaft to a range that is suitable for spinning the propeller.
- A3. A turboshaft engine may be used for:
 - helicopter rotors,
 - electrical generators,
 - compressors,
 - pumps,
 - marine propulsion systems (eg, ships), and / or
 - land propulsion systems (eg, tanks).

END OF LESSON CONFIRMATION

QUESTIONS:

- Q1. How does a turbojet generate thrust?
- Q2. How can a turbofan be visually identified?
- Q3. How is a free turbine turboprop different from a fixed shaft turboprop?

ANTICIPATED ANSWERS:

- A1. A turbojet generates thrust by imparting a relatively large acceleration to a relatively small mass of air.
- A2. Turbofans typically have an air intake that is two to four times the diameter of the exhaust nozzle.
- A3. In a free turbine turboprop, a separate turbine is used to turn the shaft connected to the propeller. In a fixed shaft turboprop, the same turbine turns both the compressor blades and the shaft connected to the propeller.

CONCLUSION

HOMEWORK / READING / PRACTICE

Nil.

METHOD OF EVALUATION

Nil.

CLOSING STATEMENT

Being able to describe gas turbine engines is important for understanding more complex material. A solid understanding of gas turbine engines is required to pursue future aviation training and provides knowledge for potential instructional duties.

INSTRUCTOR NOTES / REMARKS

Nil.

REFERENCES

C3-116 ISBN 0-9680390-5-7 MacDonald, A. F., & Pepler, I. L. (2000). *From the ground up: Millennium edition*. Ottawa, ON: Aviation Publishers Co. Limited.

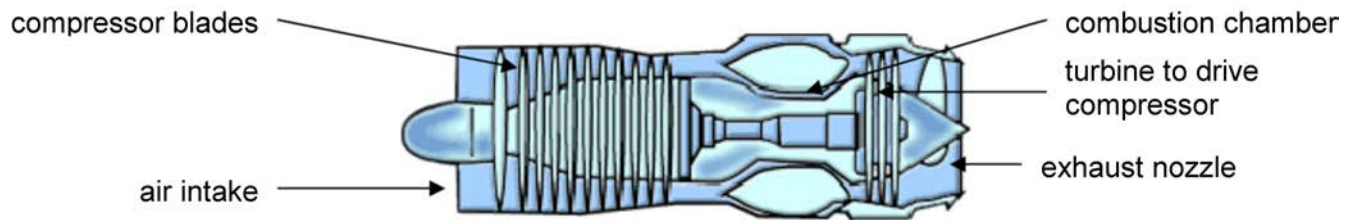

Figure A-1 Turbojet Engine

Note. From "Engines", *NASA Ultra Efficient Engine Technology*. Retrieved March 19, 2009, from <http://www.ueet.nasa.gov/StudentSite/engines.html>

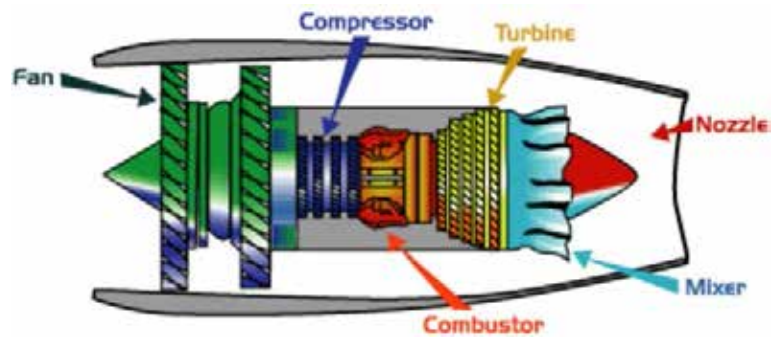

Figure A-2 Turbofan Engine

Note. From "Engines", *NASA Ultra Efficient Engine Technology*. Retrieved March 19, 2009, from <http://www.ueet.nasa.gov/StudentSite/engines.html>

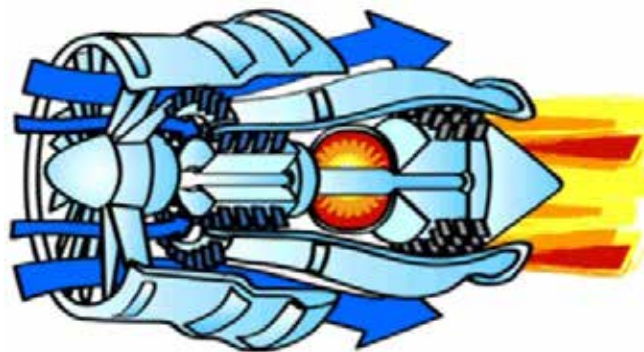

Figure A-3 Airflow Through a Turbofan Engine

Note. From "Engines", *NASA Ultra Efficient Engine Technology*. Retrieved March 19, 2009, from <http://www.ueet.nasa.gov/StudentSite/engines.html>

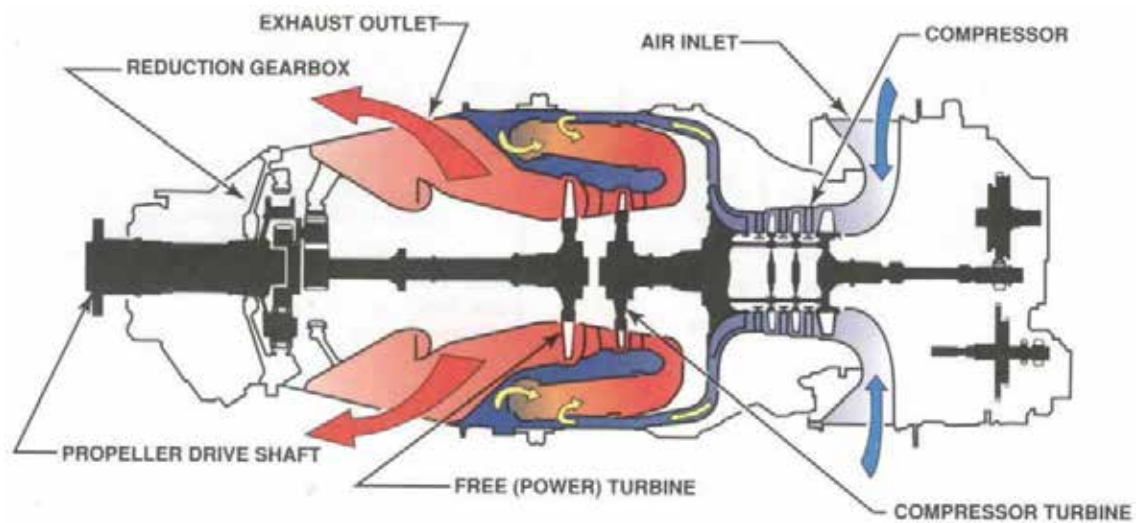

Figure A-4 Free Turbine Turboprop Engine

Note. From *A&P Technician Powerplant* (p. 3-6), by Jeppesen Standard Training Products, 2000, Englewood, CO:Jeppesen Sanderson Training Systems.



**ROYAL CANADIAN AIR CADETS
PROFICIENCY LEVEL FOUR
INSTRUCTIONAL GUIDE**



SECTION 1

EO M436.01 – EXPLAIN WINDS

Total Time:

30 min

PREPARATION

PRE-LESSON INSTRUCTIONS

Resources needed for the delivery of this lesson are listed in the lesson specification located in A-CR-CCP-804/PG-001, *Proficiency Level Four Qualification Standard and Plan*, Chapter 4. Specific uses for said resources are identified throughout the instructional guide within the TP for which they are required.

Review the lesson content and become familiar with the material prior to delivering the lesson.

Prepare the slides or handouts located at Attachment A.

PRE-LESSON ASSIGNMENT

Nil.

APPROACH

An interactive lecture was chosen for this lesson to orient the cadets to winds and generate interest in the subject.

INTRODUCTION

REVIEW

Nil.

OBJECTIVES

By the end of this lesson the cadet shall have explained winds.

IMPORTANCE

It is important for the cadets to explain winds as this information is used by pilots to be aware of the direction and speed of wind during all parts of the flight. Being able to explain winds provides knowledge for potential instructional duties and is part of the fundamentals that cadets pursuing future aviation training will require.

Teaching Point 1**Explain surface winds.**

Time: 15 min

Method: Interactive Lecture

SURFACE WINDS

Wind is a major factor in flight planning and flight characteristics. Pilots must constantly be aware of the direction and speed of wind during the flight, especially when close to the ground during takeoff and landing.

Surface friction plays an important role in the speed and direction of surface winds. The friction between the air and the ground slows the air down causing a lower wind speed than would be expected from the pressure gradient. The friction also changes the direction causing the wind to blow across the isobars toward the centre of a low pressure area and away from the centre of a high pressure area.

The effect of surface friction usually does not extend more than a couple of thousand feet into the air. At 3 000 feet above the ground, the wind blows parallel to the isobars with a speed proportional to the pressure gradient.

Hills and valleys substantially distort the airflow associated with the prevailing pressure system and the pressure gradient. Katabatic and anabatic winds and mountain waves are examples of wind phenomena in mountainous areas.

Katabatic and Anabatic Winds

Show slides of Figures A-1 and A-2.

At night, the sides of hills cool by radiation. The air in contact with them becomes cooler and denser, and blows down the slope into the valley. A katabatic wind is the term for down slope winds flowing from high elevations down the slopes to valleys below. If the slopes are covered with ice and snow, the katabatic wind can also carry the cold dense air into the warmer valleys during the day.

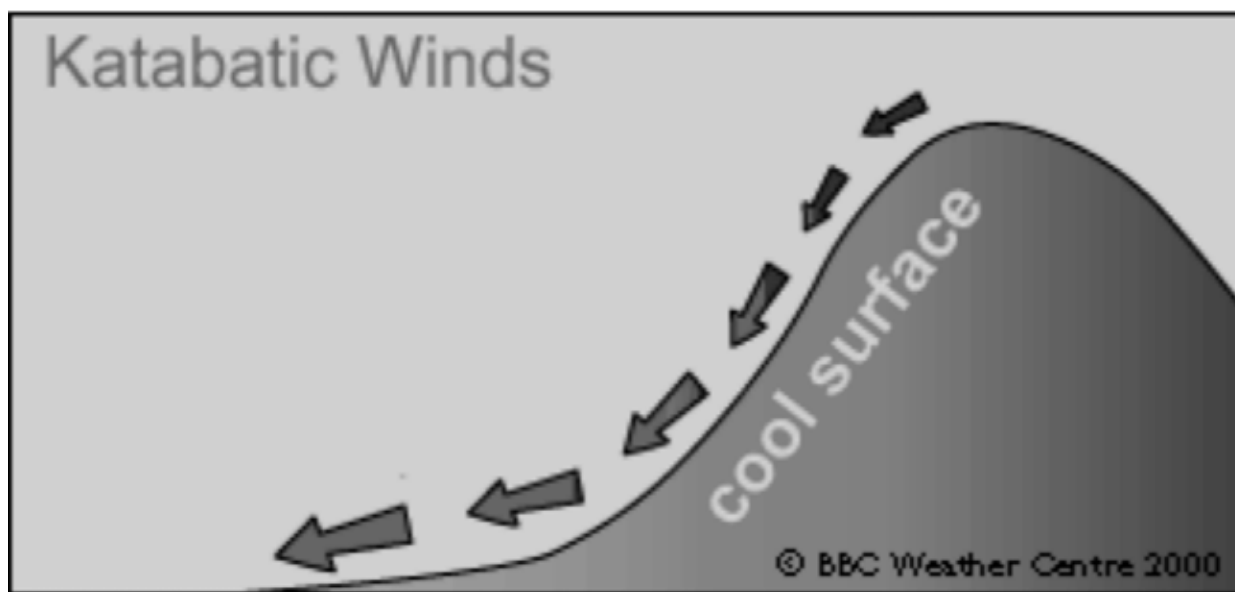

Figure 1 Katabatic Wind

Note. From "Wind", by BBC, 2008. Copyright 2000 by BBC Weather Centre. Retrieved October 14, 2008, from http://www.bbc.co.uk/weather/weatherwise/factfiles/basics/wind_localwinds.shtml

Anabatic wind occurs during the day when the slopes of hills, not covered by snow, are warmed. The air in contact with them becomes warmer and less dense, therefore flowing up the slope.

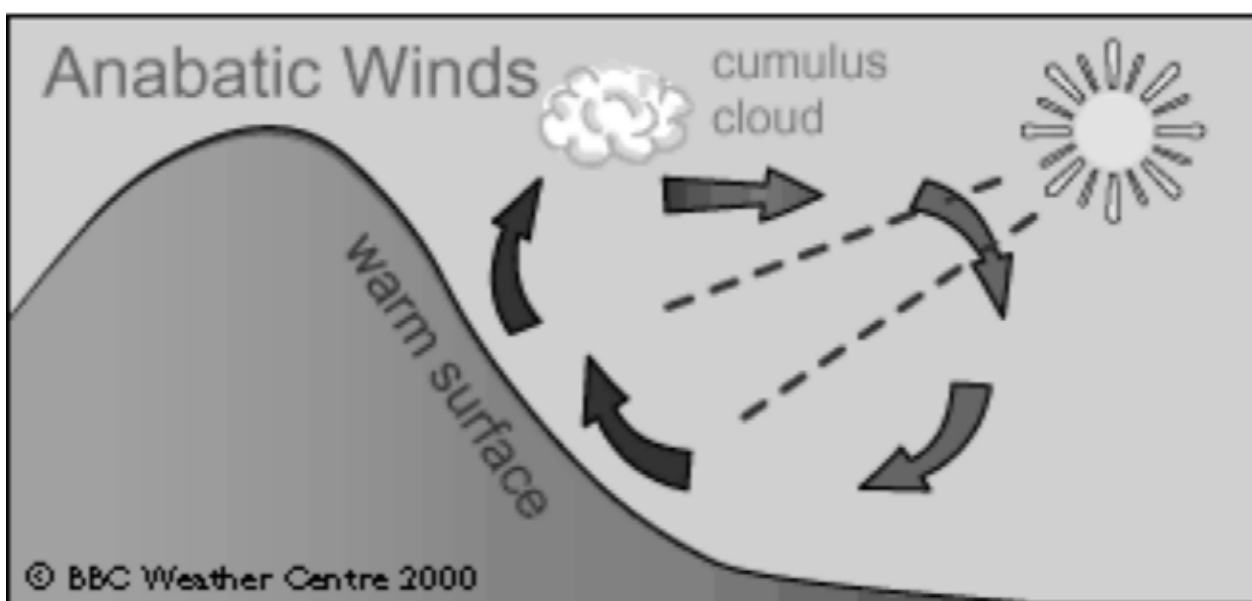

Figure 2 Anabatic Wind

Note. From "Wind", by BBC, 2008. Copyright 2000 by BBC Weather Centre. Retrieved October 14, 2008, from http://www.bbc.co.uk/weather/weatherwise/factfiles/basics/wind_localwinds.shtml

Mountain Waves



Show slide of Figure A-3.

Air flowing across a mountain range usually rises smoothly up the slope of the range. Once over the top, it pours down the other side with considerable force, bouncing up and down, creating eddies and turbulence. It also creates powerful vertical waves that may extend for great distances downwind of the mountain range. This phenomenon is known as a mountain wave. The most severe mountain wave conditions are created in strong airflows that are blowing at right angles to the mountain range in very unstable air.

If the air mass has high moisture content, clouds of a very distinctive appearance will develop, thereby serving as a warning to pilots. Orographic lift causes a cap cloud to form along the top of the ridge. Lenticular (lens-shaped) clouds form in the wave crests aloft and lie in bands that may extend well above 40 000 feet. Rotor clouds resemble a long line of stratocumulus clouds and form in the rolling eddies downstream.

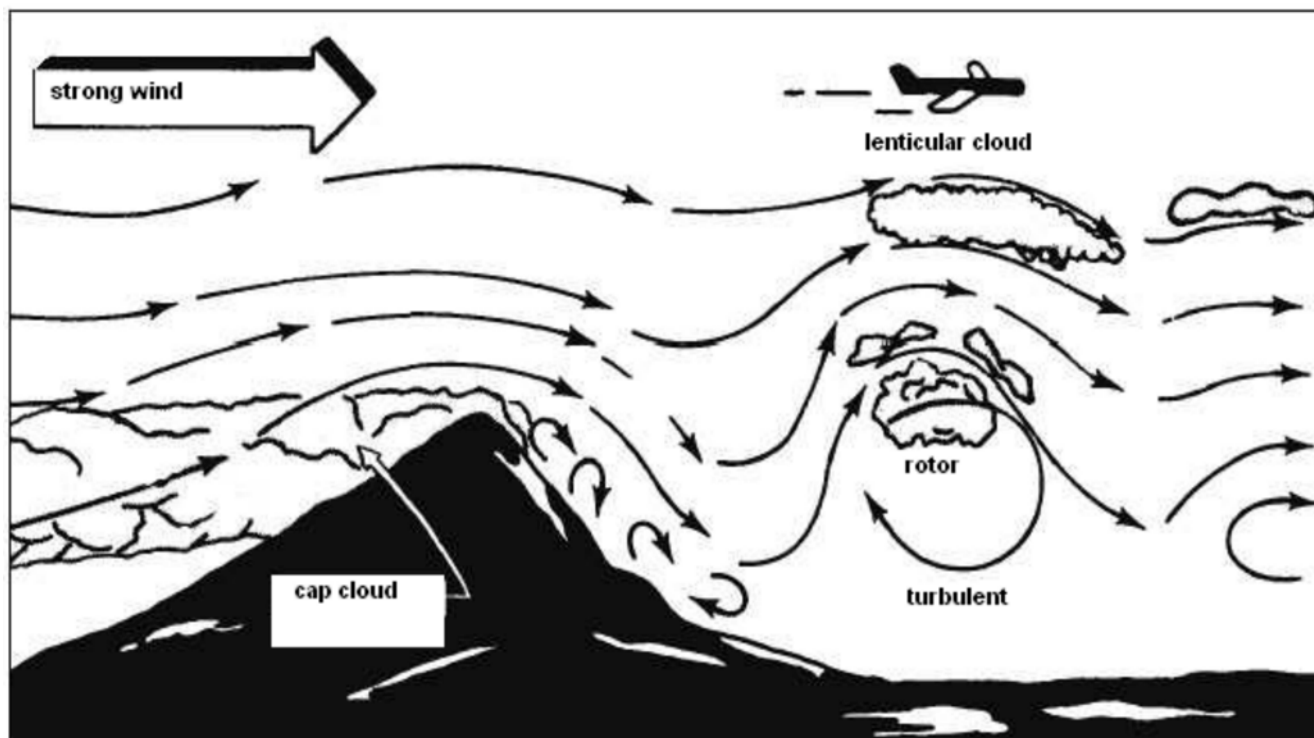

Figure 3 Mountain Wave

Note. From "Integrated Publishing", 2003. *Aerographer / Meteorology*, Copyright 2003 by Integrated Publishing. Retrieved October 14, 2008, from <http://www.tpub.com/weather2/3-25.htm>

Mountain waves may cause many dangers to aircraft, such as:

- common downdrafts of 2 000 feet per minute along the downward slope;
- extremely severe turbulence in the air layer between the ground and the tops of the rotor clouds;
- severe wind shear due to wind speed variation between the crests and troughs of the waves;

- severe icing due to large supercooled droplets sustained in the strong vertical currents; and
- an altimeter error of more than 3 000 feet on the high side due to the increase in wind speed and accompanying decrease in pressure.

Gusts

A gust is a rapid and irregular change of wind speed and may be associated with a rapid change in wind direction. Gusts are caused by mechanical turbulence that results from friction between the air and the ground and by the unequal heating of the earth's surface, particularly during hot summer afternoons.



Wind gusts are a hazard to gliders due to their light weight and relatively slow stalling speed. Therefore, the Air Cadet Gliding Program has a maximum permissible gust differential of 10 knots (12 mph). Any gust differential beyond this will require an immediate shutdown of gliding operations.

Squalls

A squall is a sudden increase in the strength of the wind of longer duration than a gust and like a gust, may be accompanied by a rapid change of wind direction. Squalls may be caused by the passage of a fast moving cold front or thunderstorm.

CONFIRMATION OF TEACHING POINT 1

QUESTIONS:

- Q1. Explain anabatic wind.
- Q2. What types of clouds are caused by mountain waves?
- Q3. What causes gusts?

ANTICIPATED ANSWERS:

- A1. Anabatic wind occurs during the day when the slopes of hills not covered by snow are warmed. The air in contact with them becomes warmer and less dense, therefore flowing up the slope.
- A2. Cap clouds, lenticular clouds, and rotor clouds.
- A3. Gusts are caused by mechanical turbulence that results from friction between the air and the ground and by the unequal heating of the earth's surface.

Teaching Point 2

Describe jet streams.

Time: 10 min

Method: Interactive Lecture

JET STREAMS



Show slides of Figures A-4 and A-5.

Jet streams are narrow bands of exceedingly high speed winds that exist in the higher levels of the atmosphere at altitudes ranging from 20 000 to 40 000 feet or more. They flow from west to east and are usually 300 nautical miles wide and 3 000 to 7 000 feet thick. Winds in the central core of a jet stream are generally between 100 and 150 knots, although they may reach speeds as great as 250 knots.

The northern hemisphere has two such streams: the mid-latitude (polar) jet, which is the one usually affecting weather in North America, Europe and Asia, and the subtropical jet.

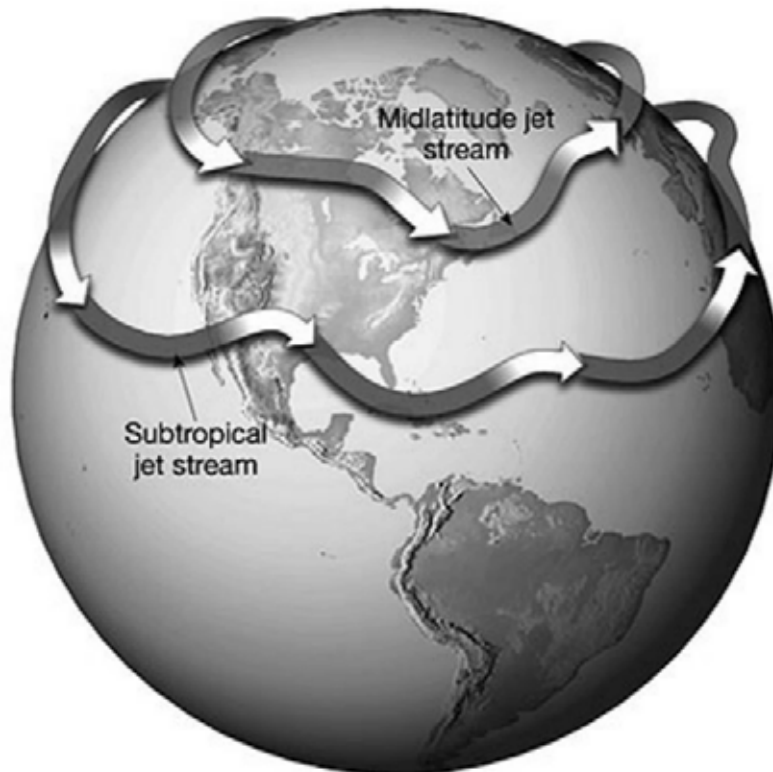

Figure 4 The Jet Stream

Note. From "Remote Sensing Tutorial", by N. Short, 2005, *Federation of American Scientists*. Retrieved February 26, 2009, from http://www.fas.org/irp/imint/docs/rst/Sect14/Sect14_1c.html

When the mid-latitude jet is farther north, in Canada, the weather to its south tends to be mild or at least less cold. When the stream swings south well within the United States (U.S.), especially in winter, very cold, often harsh weather prevails at the surface on the northern side.

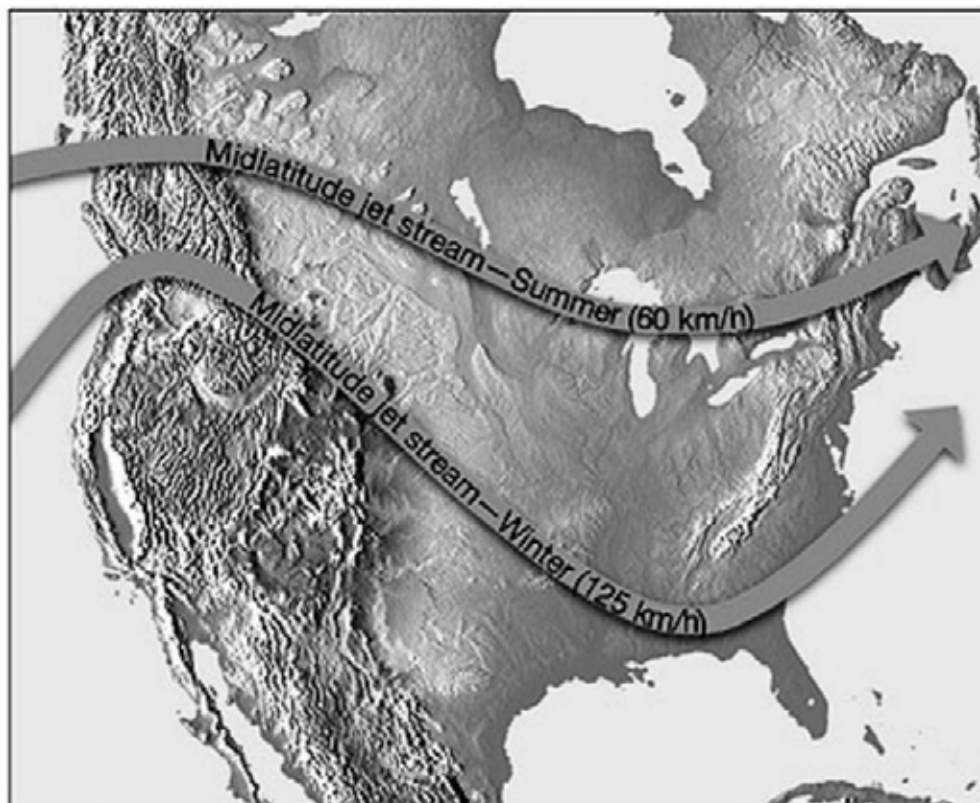

Figure 5 Seasonal Mid-Latitude Jet Stream

Note. From "Remote Sensing Tutorial", by N. Short, 2005, *Federation of American Scientists*. Retrieved February 26, 2009, from http://www.fas.org/irp/imint/docs/rst/Sect14/Sect14_1c.html

Knowing the location of a jet stream is important when planning long range flights at high altitudes. For example, on an eastbound flight a pilot would want to take advantage of the excellent tail winds a jet stream would provide. On a westbound flight they would want to avoid the winds.

Clear Air Turbulence (CAT)

CAT is a bumpy, turbulent condition that occurs in a cloudless sky. It occurs at high altitudes, usually above 15 000 feet and is more severe near 30 000 feet. The most probable place to expect CAT is just above the central core of a jet stream.

CAT is almost impossible to forecast and can be severe enough to be a hazard to modern high-performance airplanes. Therefore, knowledge of areas in which CAT is most likely to occur is important for pilots to help minimize encounters with it.

CONFIRMATION OF TEACHING POINT 2

QUESTIONS:

- Q1. What are jet streams?
- Q2. In what direction do jet streams flow?
- Q3. Where is clear air turbulence most likely to occur?

ANTICIPATED ANSWERS:

- A1. Jet streams are narrow bands of exceedingly high speed winds that exist in the higher levels of the atmosphere at altitudes ranging from 20 000 to 40 000 feet or more.
- A2. Jet streams flow from west to east.
- A3. Clear air turbulence is most likely to occur just above the central core of a jet stream.
-

END OF LESSON CONFIRMATION

QUESTIONS:

- Q1. What must pilots be aware of when close to the ground during takeoff and landing?
- Q2. List examples of wind phenomena in mountainous areas.
- Q3. What is the range of wind speeds in the central core of the jet stream?

ANTICIPATED ANSWERS:

- A1. The direction and speed of wind.
- A2. Examples include:
- katabatic winds,
 - anabatic winds, and
 - mountain waves.
- A3. 100 to 150 knots but may reach speeds as great as 250 knots.
-

CONCLUSION

HOMEWORK / READING / PRACTICE

Nil.

METHOD OF EVALUATION

This EO is assessed IAW A-CR-CCP-804/PG-001, *Proficiency Level Four Qualification Standard and Plan*, Chapter 3, Annex B, Aviation Subjects–Combined Assessment PC.

CLOSING STATEMENT

Wind is a major factor in flight planning and flight characteristics. Pilots must constantly be aware of the direction and speed of wind during all parts of the flight. Knowledge of winds is essential for future aviation training and for instructional duties at the squadron.

INSTRUCTOR NOTES / REMARKS

Cadets who are qualified Advanced Aviation may assist with this instruction.

REFERENCES

C3-116 ISBN 0-9680390-5-7 MacDonald, A. F., & Pepler, I. L. (2000). *From the ground up: Millennium edition*. Ottawa, ON: Aviation Publishers Co. Limited.

C3-334 Short, N. (2005). Remote Sensing Tutorial. *Federation of American Scientists*. Retrieved February 26, 2009, from http://www.fas.org/irp/imint/docs/rst/Sect14/Sect14_1c.html

THIS PAGE INTENTIONALLY LEFT BLANK

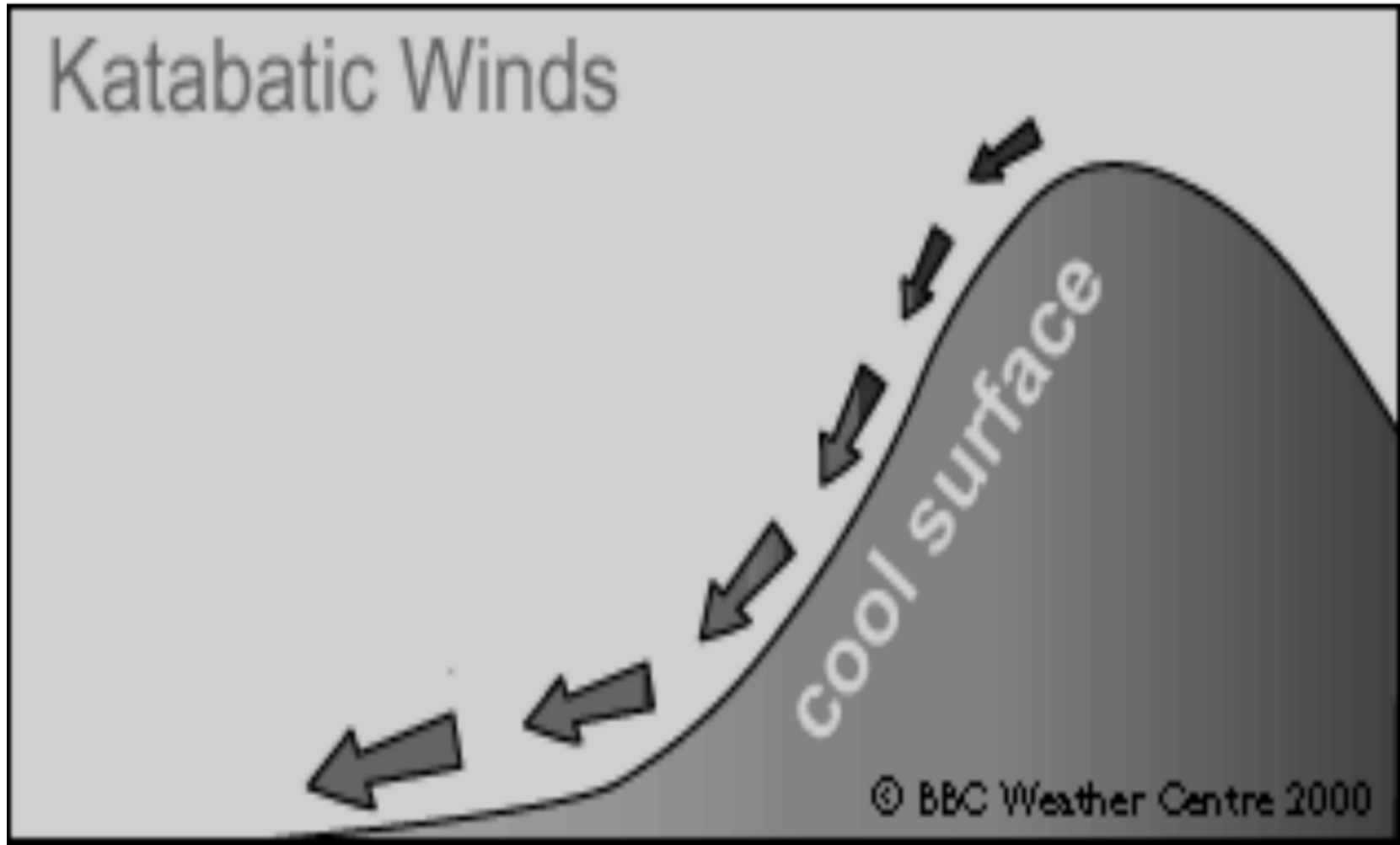

Figure A-1 Katabatic Wind

Note. From "Wind", by BBC, 2008. Copyright 2000 by BBC Weather Centre. Retrieved October 14, 2008, from http://www.bbc.co.uk/weather/weatherwise/factfiles/basics/wind_localwinds.shtml

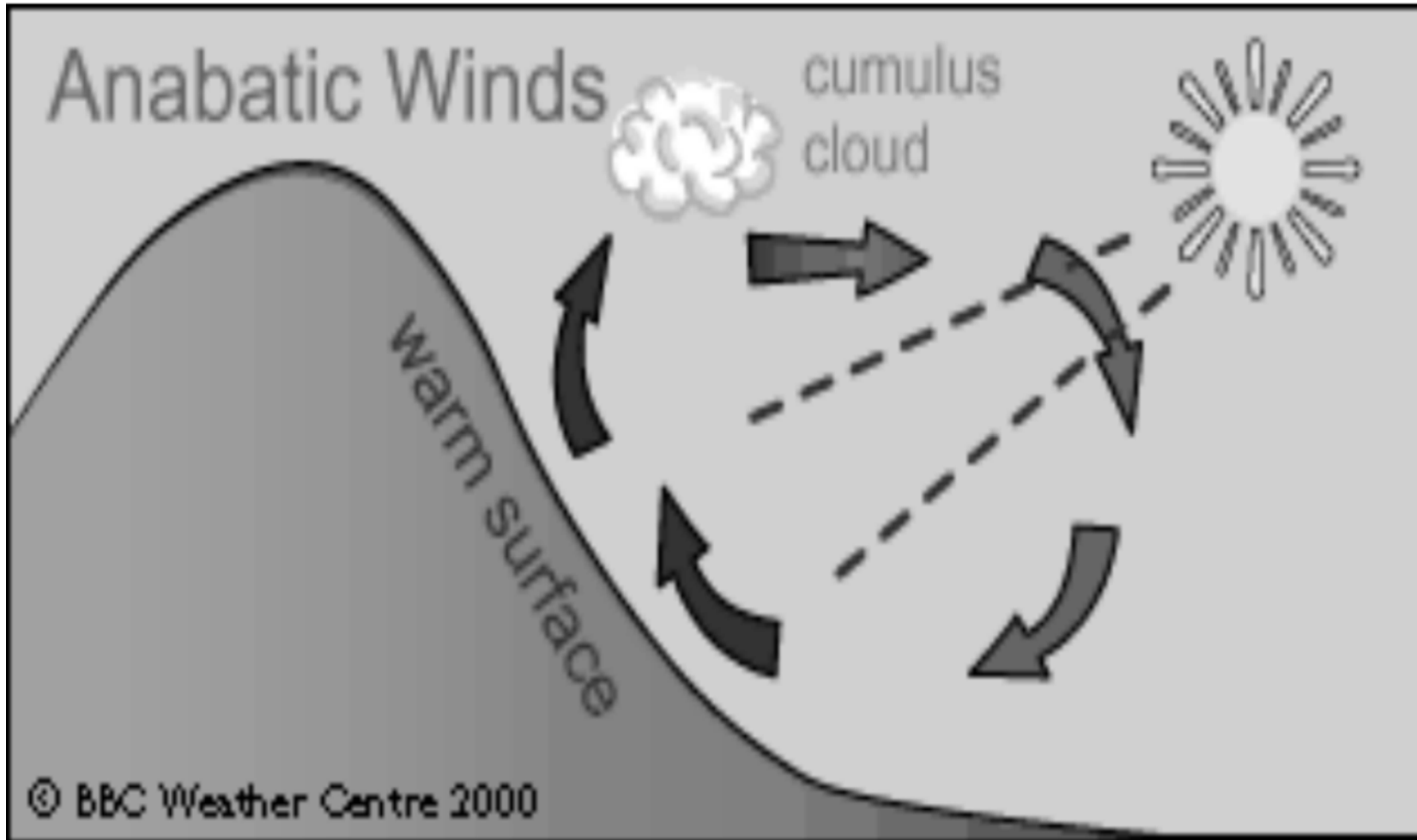

Figure A-2 Anabatic Wind

Note. From "Wind", by BBC, 2008. Copyright 2000 by BBC Weather Centre. Retrieved October 14, 2008, from http://www.bbc.co.uk/weather/weatherwise/factfiles/basics/wind_localwinds.shtml

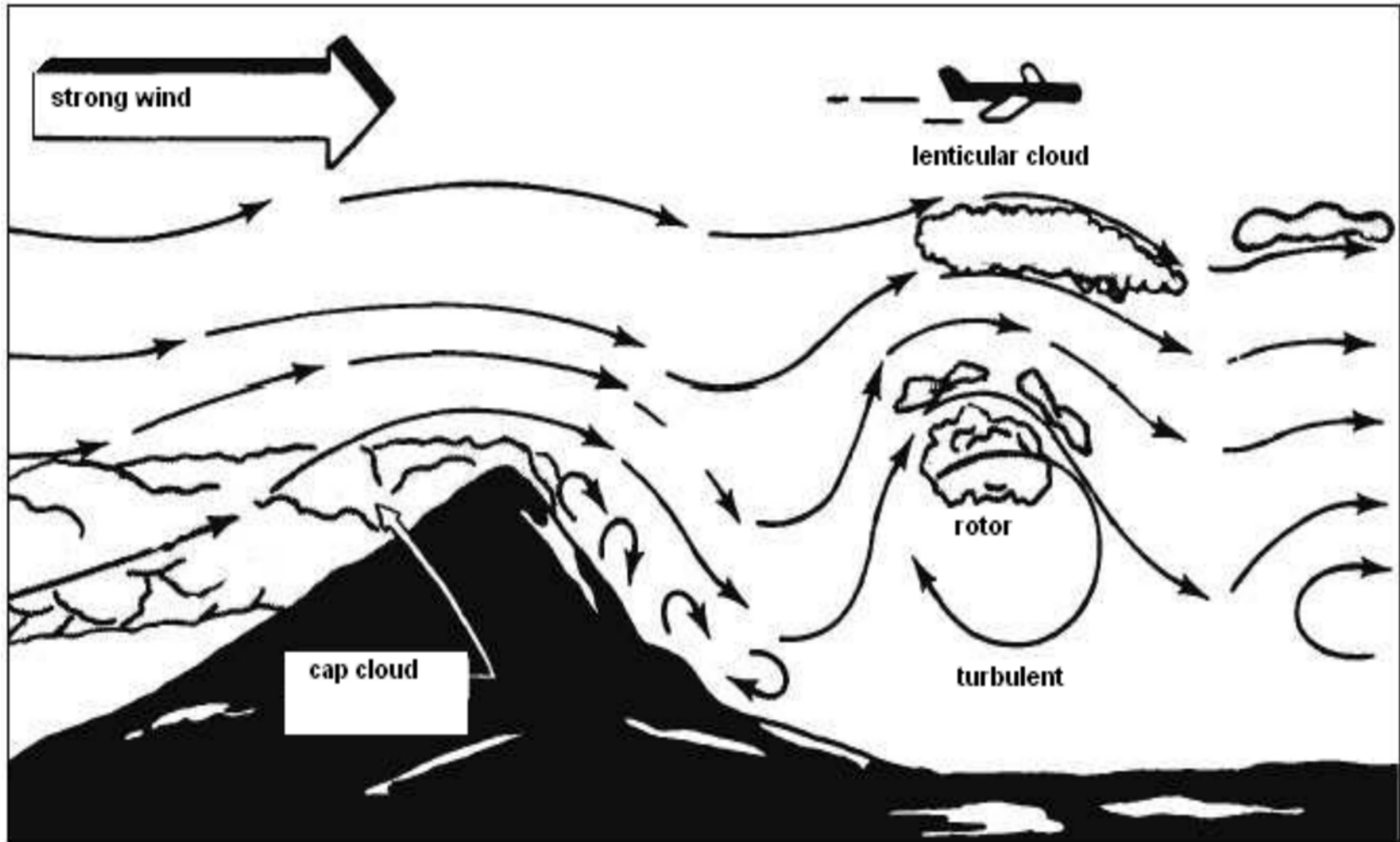

Figure A-3 Mountain Wave

Note. From "Integrated Publishing", 2003, *Aerographer / Meteorology*. Copyright 2003 by Integrated Publishing. Retrieved October 14, 2008, from <http://www.tpub.com/weather2/3-25.htm>

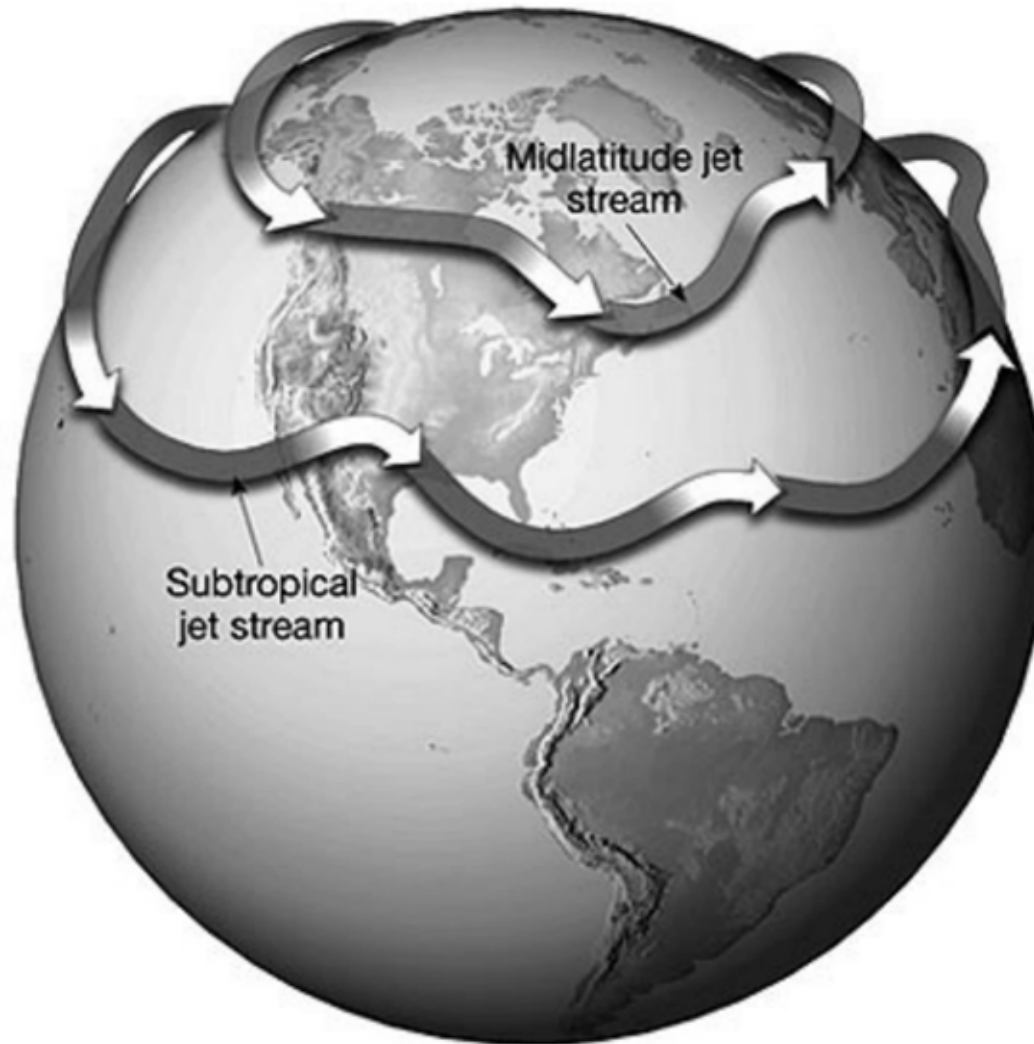

Figure A-4 The Jet Stream

Note. From "Remote Sensing Tutorial", by N. Short, 2005, *Federation of American Scientists*. Retrieved February 26, 2009, from http://www.fas.org/irp/imint/docs/rst/Sect14/Sect14_1c.html

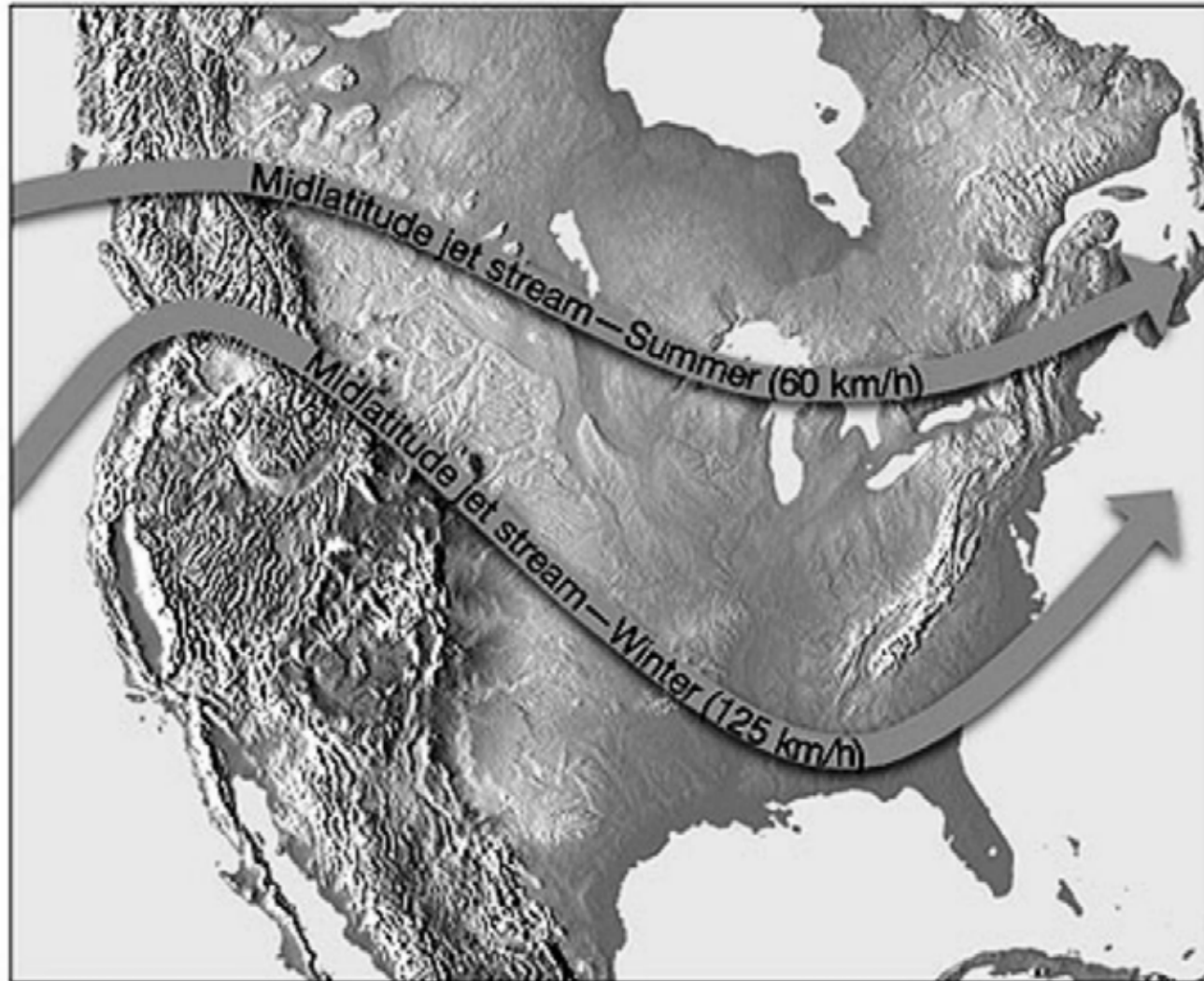

Figure A-5 Seasonal Mid-Latitude Jet Stream

Note. From "Remote Sensing Tutorial", by N. Short, 2005, *Federation of American Scientists*. Retrieved February 26, 2009, from http://www.fas.org/irp/imint/docs/rst/Sect14/Sect14_1c.html

THIS PAGE INTENTIONALLY LEFT BLANK



**ROYAL CANADIAN AIR CADETS
PROFICIENCY LEVEL FOUR
INSTRUCTIONAL GUIDE**



SECTION 2

EO M436.02 – DESCRIBE AIR MASSES AND FRONTS

Total Time:	90 min
-------------	--------

PREPARATION

PRE-LESSON INSTRUCTIONS

Resources needed for the delivery of this lesson are listed in the lesson specification located in A-CR-CCP-804/PG-001, *Proficiency Level Four Qualification Standard and Plan*, Chapter 4. Specific uses for said resources are identified throughout the instructional guide within the TP for which they are required.

Review the lesson content and become familiar with the material prior to delivering the lesson.

Review and prepare the demonstration located at Attachment A.

Prepare the slides located at Attachments B and C.

Photocopy the handout located at Attachment D for each cadet.

Prepare the learning stations located at Attachments E–I.

Photocopy a set of the fronts worksheets located at Attachment J for each cadet.

PRE-LESSON ASSIGNMENT

Nil.

APPROACH

An interactive lecture was chosen for TPs 1 and 2 to orient the cadets to air masses and fronts and generate interest in the subject.

An in-class activity was chosen for TP 3 as it is an interactive way to present types of fronts and associated weather.

INTRODUCTION

REVIEW

Nil.

OBJECTIVES

By the end of this lesson the cadet shall be expected to describe air masses and fronts.

IMPORTANCE

It is important for cadets to describe air masses and fronts as knowledge of this material helps them to understand changes in weather conditions. Being able to describe air masses and fronts provides knowledge for potential instructional duties and is part of the fundamentals that cadets pursuing future aviation training will require.

Teaching Point 1**Explain weather in an air mass.**

Time: 10 min

Method: Interactive Lecture

WEATHER IN AN AIR MASS

There are three main factors that determine the weather in an air mass:

- moisture content,
- the cooling process, and
- the stability of the air.

Moisture Content

Continental air masses are very dry and little cloud develops. The high moisture content in maritime air may cause cloud, precipitation, and fog.

The Cooling Process

Even if the air is moist, condensation and cloud formation only occur if the temperature is lowered to the dewpoint. The cooling processes that contribute to condensation and the formation of clouds are:

- contact with a surface cooling by radiation,
- advection over a colder surface, and
- expansion brought about by lifting.

Cloud formation within an air mass is not uniform. For example, clouds may form in an area where the air is undergoing orographic lift even though the rest of the air mass is clear.

The Stability of the Air

In stable air, stratus cloud and poor visibility are common, whereas in unstable air, cumulus cloud and good visibility are common.

Characteristics of Cold Air Masses and Warm Air Masses

Cold air masses (eg, arctic and polar air masses) will typically have the following characteristics:

- instability,
- turbulence,
- good visibility,
- cumuliform clouds, and
- precipitation in the form of showers, hail, and thunderstorms.

Warm air masses (eg, tropical air masses) will typically have the following characteristics:

- stability,
- smooth air,
- poor visibility,

- stratiform clouds and fog, and
- precipitation in the form of drizzle.

CONFIRMATION OF TEACHING POINT 1

QUESTIONS:

- Q1. What are the three main factors that determine weather in an air mass?
- Q2. What are the cooling processes that contribute to condensation and the formation of clouds?
- Q3. What are the characteristics of a warm air mass?

ANTICIPATED ANSWERS:

- A1. Moisture content, the cooling process, and the stability of the air.
- A2. Contact with a surface cooling by radiation, advection over a colder surface, and expansion brought about by lifting.
- A3. Stability, smooth air, poor visibility, stratiform clouds and fog, and precipitation in the form of drizzle.

Teaching Point 2

Define and explain types of fronts.

Time: 15 min

Method: Interactive Lecture

FRONTS

A front is the transition zone between two air masses. The interaction of air masses along their frontal zones is responsible for weather changes.



Conduct the demonstration outlined at Attachment A to illustrate the mixing of warm and cold air masses:

1. Allow the cadets to move closer so they can observe what will happen.
2. Have the cadets predict what will happen when the divider is removed.
3. Observe the action between the red and blue colored water.



The blue-dyed water represents a cold air mass and the red-dyed water represents a warm air mass. The area where these two air masses meet and mix is a front.



Show the slides located at Attachment B as fronts are presented.

The blue water (colder and more dense) will slide underneath the warmer water which is the same that occurs to the air.



Figure 1 Cold Front

Note. From Remote Sensing Tutorial by N. Short, 2005, *Federation of American Scientists*. Retrieved February 26, 2009, from http://www.fas.org/irp/imint/docs/rst/Sect14/Sect14_1c.html

The cold air mass is more dense and therefore sinks, undercutting the warm air which will ascend over the cold air.

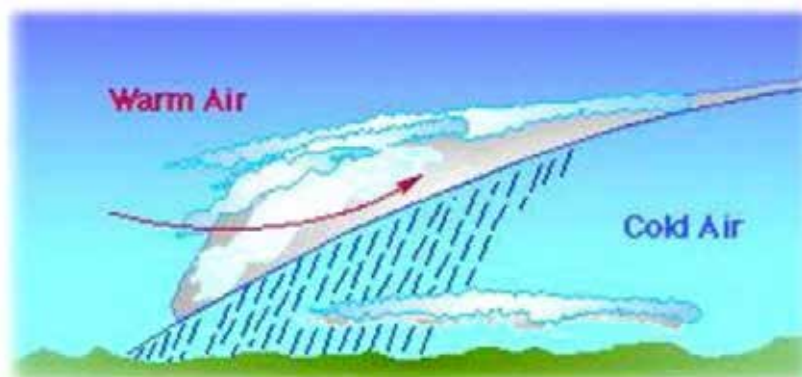

Figure 2 Warm Front

Note. From Remote Sensing Tutorial by N. Short, 2005, *Federation of American Scientists*. Retrieved February 26, 2009, from http://www.fas.org/irp/imint/docs/rst/Sect14/Sect14_1c.html



Show the slides located at Attachment C as front symbols are presented.

An air mass is a large section of the troposphere with uniform properties of temperature and moisture in the horizontal. An air mass can be several thousands of kilometers across and takes on the properties from the surface over which it formed.

Formation over ice and snow of the arctic will be dry and cold. Formation over the South Pacific will be warm and moist. Formation over a large body of water is moist and is referred to as maritime air. An air mass over a large land area is dry and is referred to as continental air.

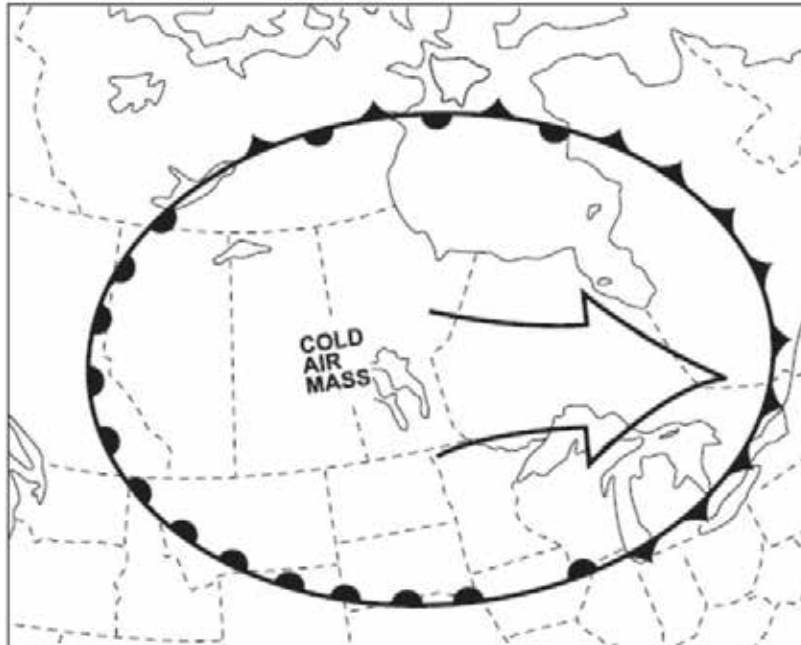



Figure 3 Air Masses and Fronts

Note. From *Air Command Weather Manual* (p. 6-8), 2004, Winnipeg, MB: Wing Publishing Office. Copyright 2004 by Her Majesty the Queen in Right of Canada.



Distribute the handout located at Attachment D to each cadet. Cadets will label each symbol as the information is presented.

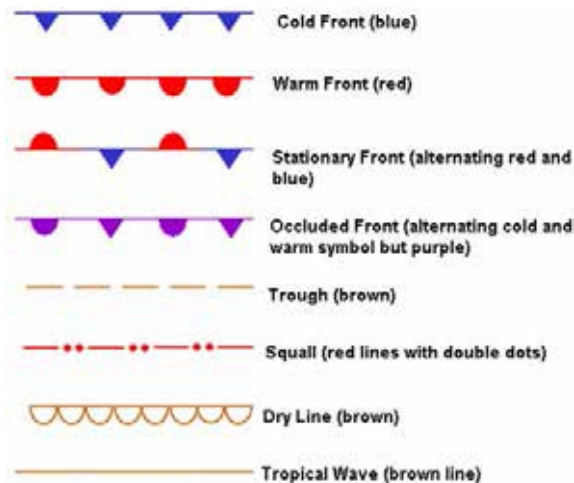

Figure 4 Front Symbols

Note. From "Weather", About.com, by R Oblanck, Copyright 2009 by The New York Times Company. Retrieved February 27, 2009 from http://weather.about.com/od/frontsandairmasses/qt/front_symbols.htm

CONFIRMATION OF TEACHING POINT 2**QUESTIONS:**

- Q1. Define a front.
- Q2. What does the interaction of air masses along their frontal zones cause?
- Q3. Explain what happens when a cold air mass and a warm air mass meet.

ANTICIPATED ANSWERS:

- A1. A front is the transition zone between two air masses.
- A2. Changes in the weather.
- A3. The air in a cold air mass is more dense and therefore sinks, undercutting the warm air. The air in a warm air mass will ascend over the cold air.

Teaching Point 3**Conduct an in-class activity to describe types of fronts and associated weather.**

Time: 55 min

Method: In-Class Activity

ACTIVITY**OBJECTIVE**

The objective of this activity is to have the cadets identify different types of fronts and their associated weather.

RESOURCES

- Pen / pencil,
- Coloured pencils / markers,
- Fronts information sheets located at Attachments E–I, and
- Fronts worksheets located at Attachment J.

ACTIVITY LAYOUT

Set up and clearly mark five learning stations, located at Attachments E–I.

ACTIVITY INSTRUCTIONS

1. Distribute all five fronts worksheets and a pen / pencil to each cadet.
2. Divide the cadets into groups of two or three and place each group at one of the learning stations.
3. Have the cadets fill out the appropriate fronts worksheet for that station.



At learning stations with more than one diagram the cadet can choose which one to draw.

4. After nine minutes have the groups rotate to the next station until each group has completed all five stations.
5. Review the fronts worksheets as a class and answer any questions.

SAFETY

Nil.

CONFIRMATION OF TEACHING POINT 3

The cadets' participation in the activity will serve as the confirmation of this TP.

END OF LESSON CONFIRMATION

QUESTIONS:

- Q1. What are the characteristics of a cold air mass?
- Q2. What clouds indicate the passing of a warm front?
- Q3. What is the term for the wedge-shaped mass of warm air lying above the colder air masses in an occluded front?

ANTICIPATED ANSWERS:

- A1. Instability, turbulence, good visibility, cumuliform clouds, and precipitation in the form of showers, hail, and thunderstorms.
 - A2. Cirrus, cirrostratus, altostratus, nimbostratus, and stratus.
 - A3. Trowal.
-

CONCLUSION

HOMEWORK / READING / PRACTICE

Nil.

METHOD OF EVALUATION

This EO is assessed IAW A-CR-CCP-804/PG-001, *Proficiency Level Four Qualification Standard and Plan*, Chapter 3, Annex B, Aviation Subjects–Combined Assessment PC.

CLOSING STATEMENT

There are two basic types of weather: air mass and frontal. Knowledge of air masses and fronts is crucial for understanding weather patterns and making accurate predictions of changing weather conditions. This knowledge is essential for future aviation training and for potential instructional duties at the squadron.

INSTRUCTOR NOTES / REMARKS

It is recommended that the three periods required for this EO be scheduled consecutively.

Cadets who are qualified Advanced Aviation may assist with this instruction.

REFERENCES

A3-044 CFACM 2-700 Air Command. (2001). *Air Command weather manual*. Ottawa, ON: Department of National Defence.

C3-116 ISBN 0-9680390-5-7 MacDonald, A. F., & Pepler, I. L. (2000). *From the ground up: Millennium edition*. Ottawa, ON: Aviation Publishers Co. Limited.

C3-334 Short, N. (2005). "Remote Sensing Tutorial". *Federation of American Scientists*. Retrieved February 26, 2009, from http://www.fas.org/irp/imint/docs/rst/Sect14/Sect14_1c.html

THIS PAGE INTENTIONALLY LEFT BLANK

WARM AND COLD FRONT DEMONSTRATION OUTLINE

1. Fill a thermos / cooler / bottle with warm water and another with cold water.



Figure A-1 Air Mass Equipment

Note. Created by Director Cadets 3, 2009, Ottawa, ON: Department of National Defence

2. Add a few drops of red food colouring to the bottle with warm water.
3. Add a few drops of blue food colouring to the bottle with cold water.
4. Shake / stir each bottle to evenly mix the colouring and water.
5. Place the empty jars together to ensure an exact match.
6. Fill one jar to almost overflowing with blue-dyed water and the other jar with red-dyed water.



Figure A-2 Jars Filled

Note. Created by Director Cadets 3, 2009, Ottawa, ON: Department of National Defence

7. Place an index card or a plastic coated paper on the top of the warm (red-dyed) water jar and press down around the edges of the jar to make a seal.



Figure A-3 Card Over Red Jar

Note. Created by Director Cadets 3, 2009, Ottawa, ON: Department of National Defence

8. Place the warm water jar over the top of the cold water jar so that the edges meet.



Figure A-4 Jars Stacked with Card Inserted

Note. Created by Director Cadets 3, 2009, Ottawa, ON: Department of National Defence

9. Have an assistant gently remove the paper once the jars are stacked on each other, keeping the jars together (do this over a sink or container to catch any water that may leak out).



Figure A-5 Jars Stacked with Card Removed

Note. Created by Director Cadets 3, 2009, Ottawa, ON: Department of National Defence

10. Keeping one hand on each jar, slowly turn the jars to one side while holding the centre together.



Figure A-6 Turn Jars on Side

Note. Created by Director Cadets 3, 2009, Ottawa, ON: Department of National Defence

11. Observe the action between the red and blue colored water.

THIS PAGE INTENTIONALLY LEFT BLANK

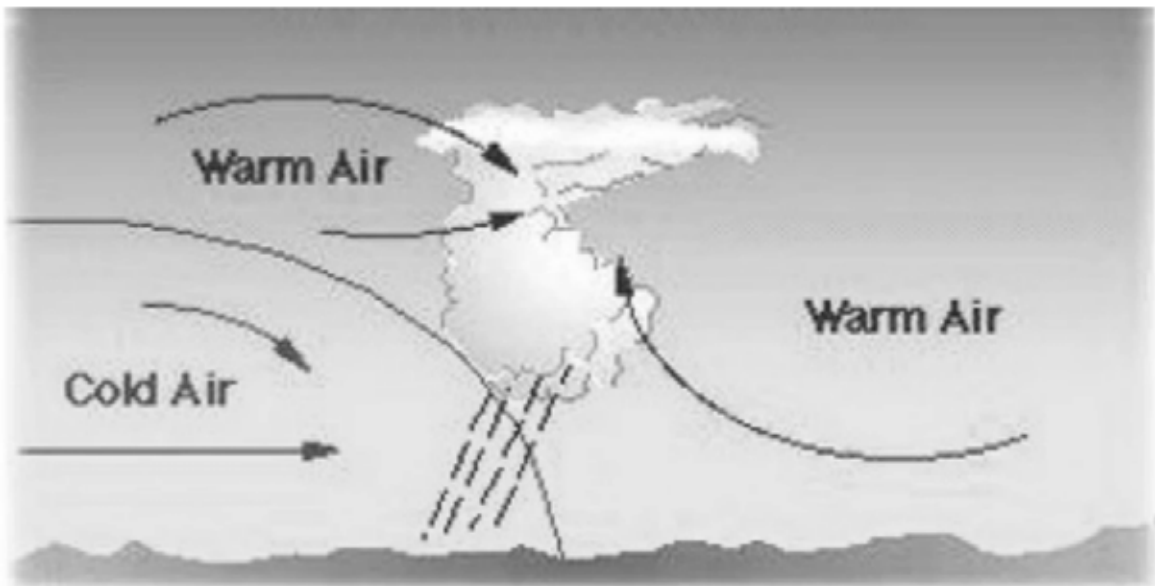

Figure B-1 Cold Front

Note. From Remote Sensing Tutorial by N. Short, 2005, *Federation of American Scientists*. Retrieved February 26, 2009, from http://www.fas.org/irp/imint/docs/rst/Sect14/Sect14_1c.html

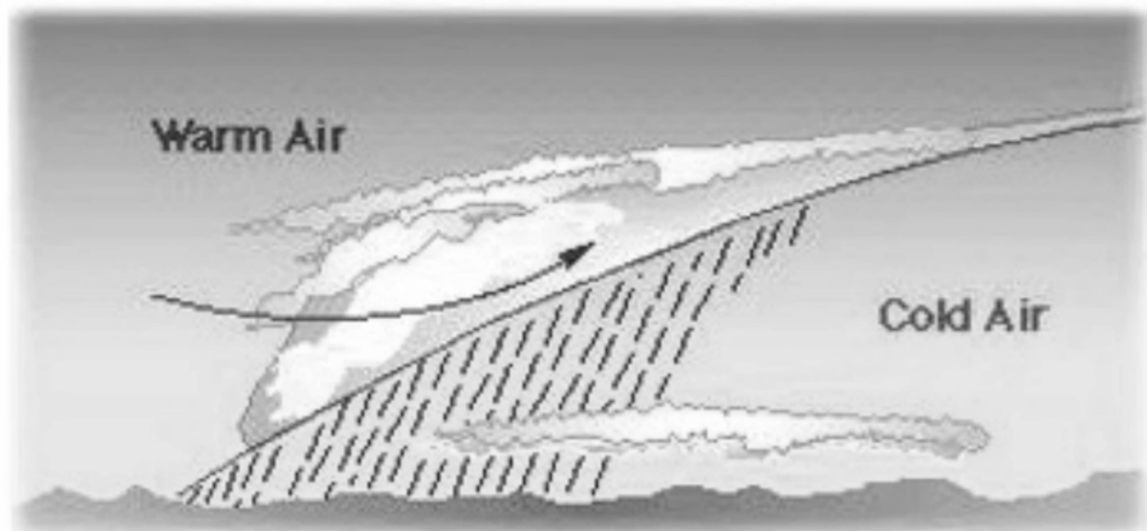

Figure B-2 Warm Front

Note. From Remote Sensing Tutorial by N. Short, 2005, *Federation of American Scientists*. Retrieved February 26, 2009, from http://www.fas.org/irp/imint/docs/rst/Sect14/Sect14_1c.html

THIS PAGE INTENTIONALLY LEFT BLANK

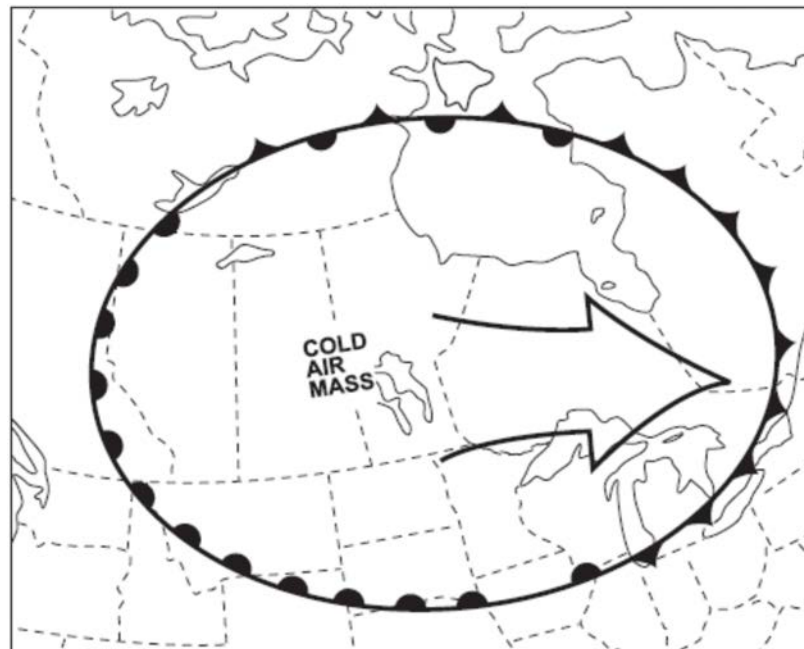

Figure C-1 Air Masses and Fronts

Note. From *Air Command Weather Manual* (p. 6-8), 2004, Winnipeg, MB: Wing Publishing Office. Copyright 2004 by Her Majesty the Queen in Right of Canada.

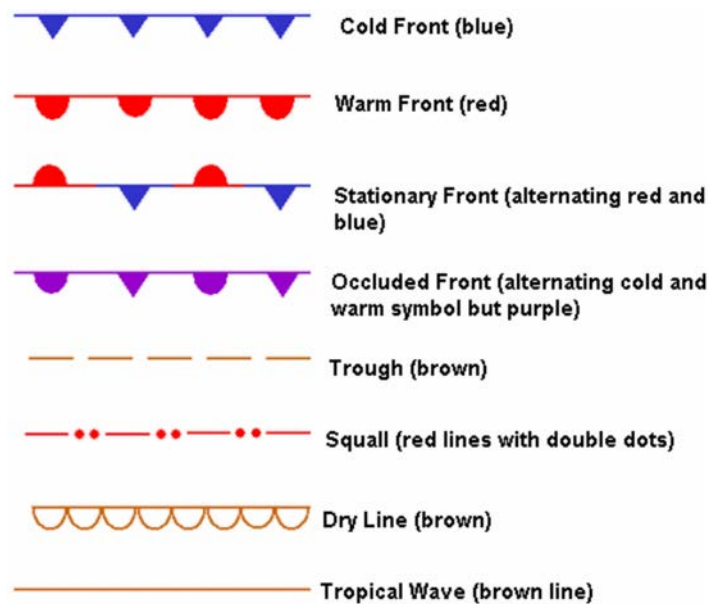
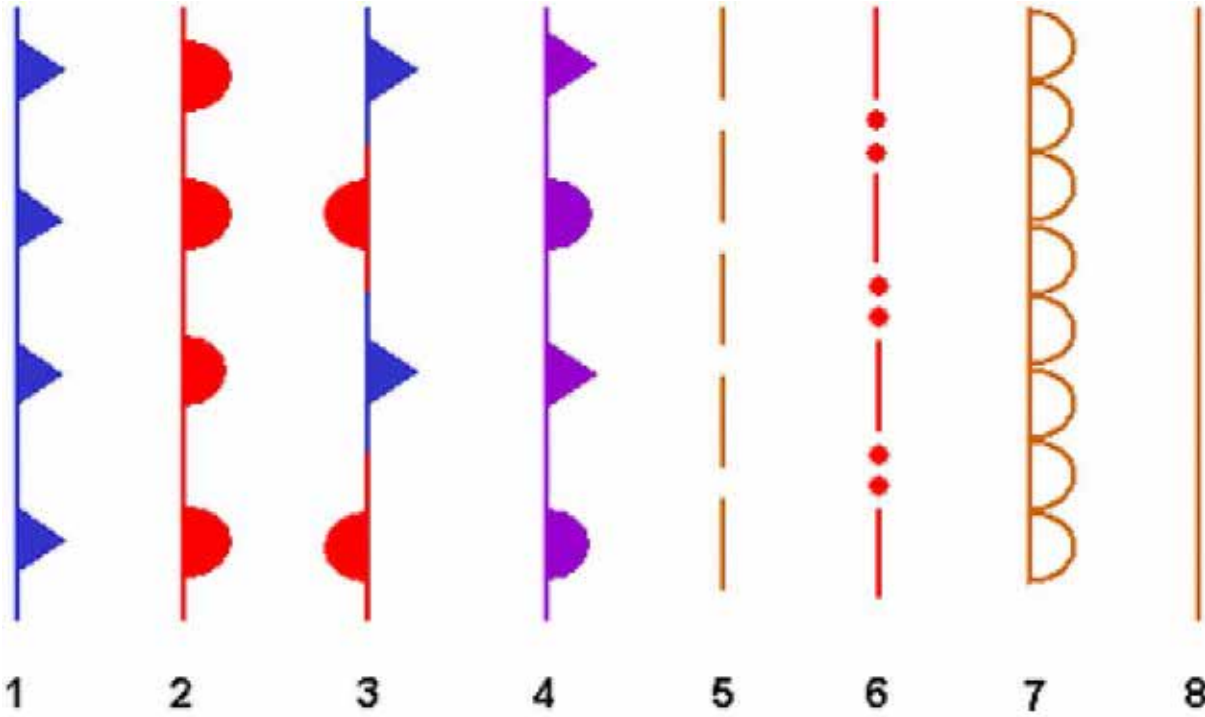

Figure C-2 Front Symbols

Note. From "Weather" About.com, by R Oblanck, Copyright 2009 by The New York Times Company. Retrieved February 27, 2009, from http://weather.about.com/od/frontsandairmasses/qt/front_symbols.htm

THIS PAGE INTENTIONALLY LEFT BLANK

WEATHER MAP SYMBOLS



	Front	Colour
1	_____	_____
2	_____	_____
3	_____	_____
4	_____	_____
5	_____	_____
6	_____	_____
7	_____	_____
8	_____	_____

THIS PAGE INTENTIONALLY LEFT BLANK

COLD FRONT

A cold front is the part of a frontal system along which cold air is advancing.

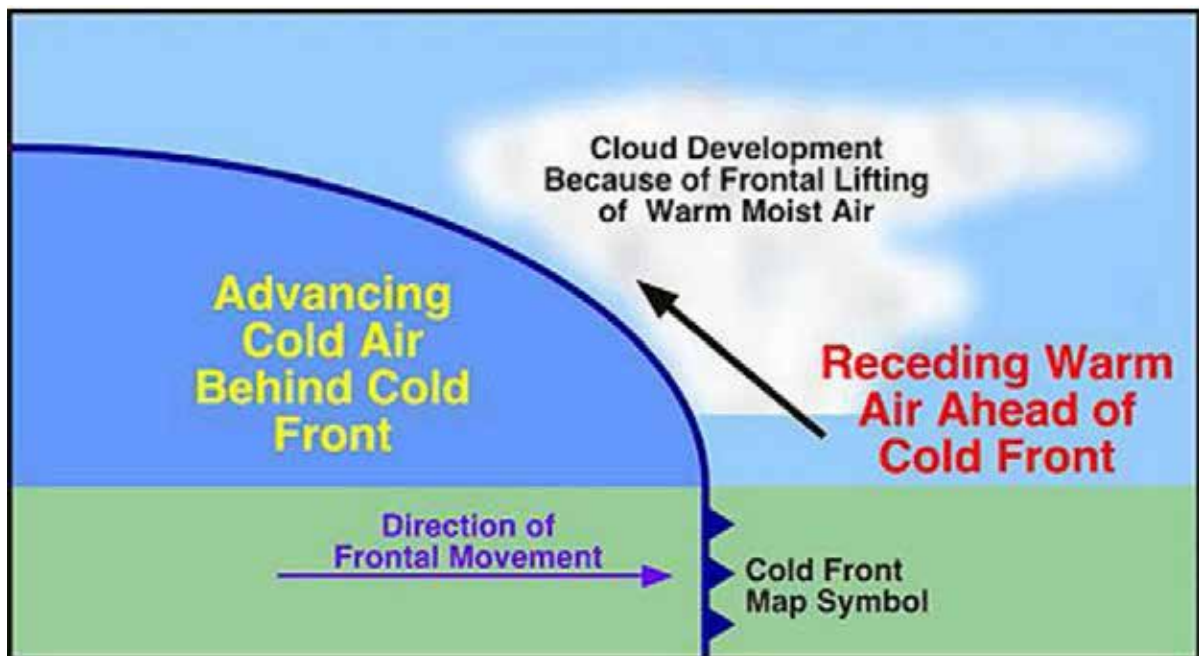

Figure E-1 Cold Front

Note. From Remote Sensing Tutorial by N. Short, 2005, *Federation of American Scientists*. Retrieved February 26, 2009, from http://www.fas.org/irp/imint/docs/rst/Sect14/Sect14_1c.html

When a mass of cold air overtakes a mass of warm air, the cold air, being denser, stays on the surface and undercuts the warm air violently. The slope of the advancing cold front is quite steep as surface friction slows the air at the surface, allowing the upper air to catch up. The rapid ascent of warm air gives rise to a relatively narrow band (only about 50 nautical miles) of cumuliform cloud that frequently builds up into violent thunderstorms.

The severity of the weather depends on the moisture content and stability of the warm air mass that the cold air mass is undercutting and the speed of the advancing cold front. If the warm air is very moist and unstable, towering cumulus clouds and thunderstorms are likely to develop, bringing heavy showers in the form of rain, snow, or hail. A slower moving cold front advancing on more stable and drier air will produce stratus or altocumulus clouds with light or no precipitation.

A squall line, a continuous line of thunderstorms, sometimes develops ahead of a fast moving cold front. The weather brought about by a squall line is extremely violent, including rapid shifts in wind, heavy rain or hail, and thunder and lightning. Pilots should avoid squall lines at all costs.

A sharp fall in temperature, a rise in pressure, and rapid clearing usually occur with the passage of the cold front.

THIS PAGE INTENTIONALLY LEFT BLANK

WARM FRONT

A warm front is the part of a frontal system along which cold air is retreating.

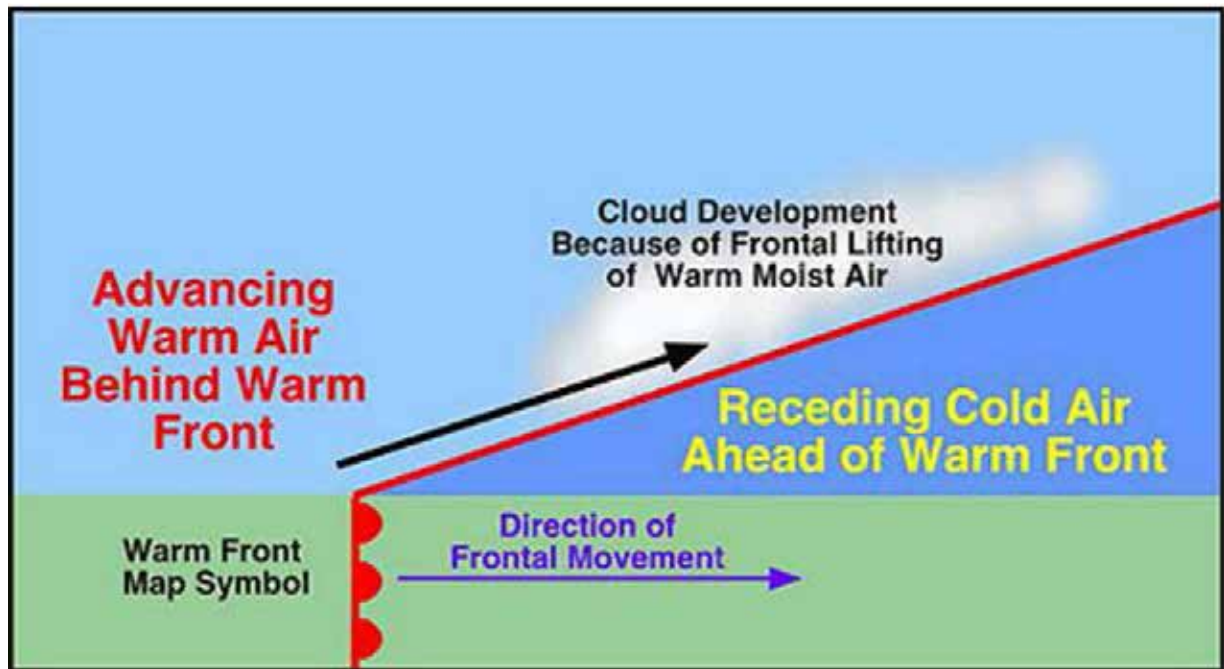

Figure F-1 Warm Front

Note. From Remote Sensing Tutorial by N. Short, 2005, *Federation of American Scientists*. Retrieved February 26, 2009, from http://www.fas.org/irp/imint/docs/rst/Sect14/Sect14_1c.html

As a mass of warm air advances on a retreating mass of cold air, the warm air, being lighter, ascends over the cold air in a long gentle slope. As a result of this long gentle slope and the relatively slow speed of warm fronts, the cloud formation associated with them may extend for 500 or more nautical miles in advance. If the warm air is moist and stable, these clouds develop in a distinctive sequence:

1. cirrus,
2. cirrostratus,
3. altostratus,
4. nimbostratus, and
5. stratus.

The clouds indicating the passing of a warm front can easily be remembered using the mnemonic "C-CANS".

If the warm air is moist and unstable, cumulonimbus and thunderstorms may be embedded in the stratiform layers, bringing heavy showers.

Warm fronts bring low ceilings and restricted visibility for a considerable length of time due to their slow movement.

In winter, when temperatures in the cold air are below freezing and temperatures in the lower levels of the warm air are above freezing, snow and freezing rain can be expected. Snow (SN) falls from the part of the warm air cloud that is high and therefore below freezing. Rain (RA) falls from the lower warm air cloud but becomes supercooled as it falls through the cold air mass. This creates freezing rain (FZRA) and ice pellets (PL). Therefore, icing is a problem associated with warm fronts in winter.

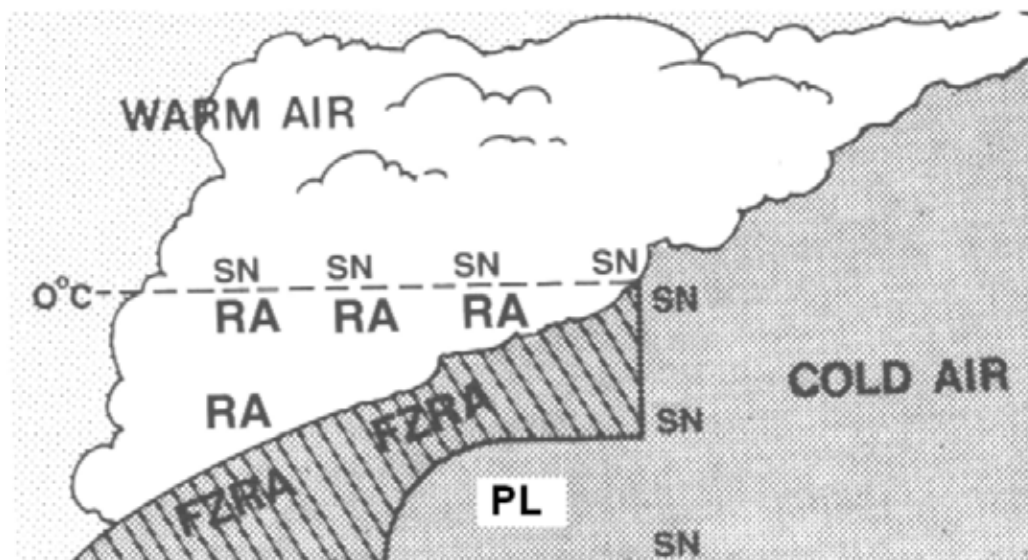

Figure F-2 Precipitation in a Warm Front in Winter

Note. From *From the Ground Up: Millennium Edition* (p. 145), by A. F. MacDonald and I. L. Peppler, 2000, Ottawa, ON: Aviation Publishers Co. Limited. Copyright 2000 by Aviation Publishers Co. Limited.

The passing of the warm front is marked by a rise of temperature due to the entry of the warm air, and the sky becoming relatively clear.

STATIONARY FRONT

A stationary front is the part of a front along which the colder air is neither advancing nor retreating.

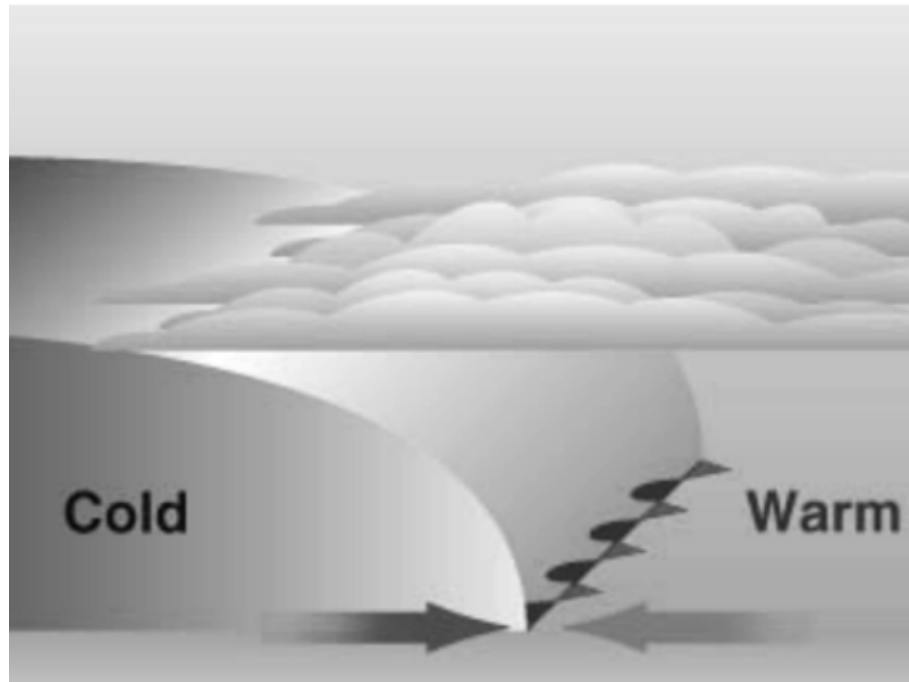

Figure G-1 Stationary Front

Note. From Geography for Kids, *KidsGeo.com*, Copyright 1998–2000. Retrieved October 17, 2008, from <http://www.kidsgeo.com/geography-for-kids/0129-stationary-fronts.php>

A stationary front occurs when the front does not move because the opposing air masses are of equal pressure. The weather conditions are similar to those associated with a warm front, (low cloud, and continuous rain or drizzle) although generally less intense and not so extensive. Usually a stationary front will weaken and eventually dissipate. Sometimes, however, it will begin to move after several days, becoming either a cold front or a warm front.

THIS PAGE INTENTIONALLY LEFT BLANK

OCCLUDED FRONTS

A wave-like disturbance sometimes forms on a stationary front. This can develop into a small low known as a depression. As the depression forms, one section of the front begins to move as a warm front and the other section as a cold front. Over time, under certain atmospheric conditions, the cold front gradually overtakes the warm front and lifts the warm air entirely from the ground forming a single occluded front. Basically, the cold air catches up with itself as it flows around the low pressure area.

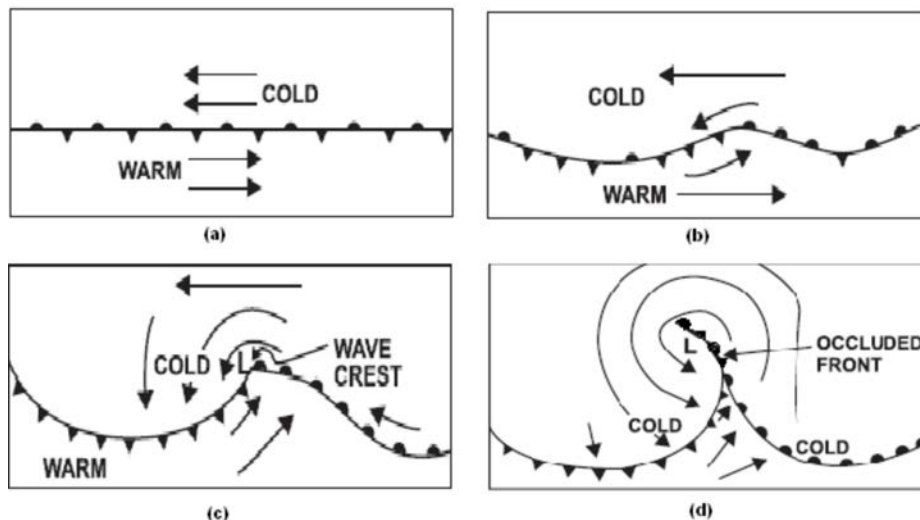

Figure H-1 Occluded Front Formation

Note. From *Air Command Weather Manual* (pp. 7-12 and 7-14), 2004, Winnipeg, MB: Wing Publishing Office. Copyright 2004 by Her Majesty the Queen in Right of Canada.

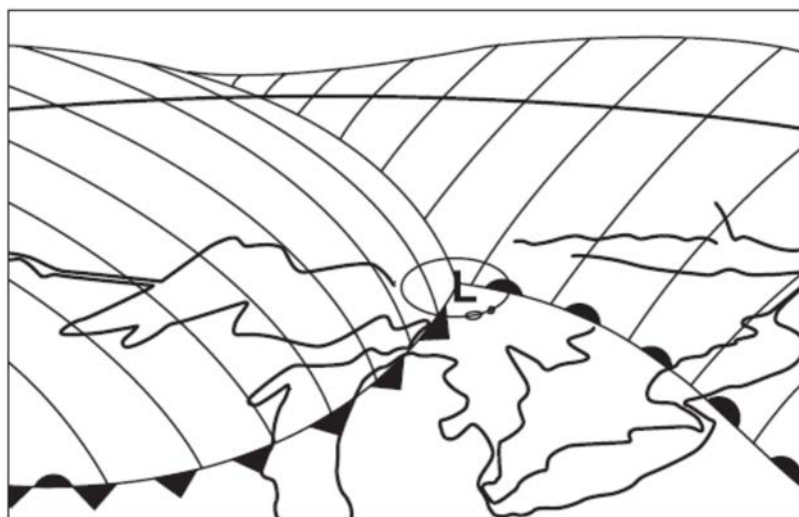

Figure H-2 Frontal Depression

Note. From *Air Command Weather Manual* (pp. 7-13), 2004, Winnipeg, MB: Wing Publishing Office. Copyright 2004 by Her Majesty the Queen in Right of Canada.

If the cold air is not as cold as the air it is overtaking (cool air advancing on cold air), the front is known as a warm occlusion.

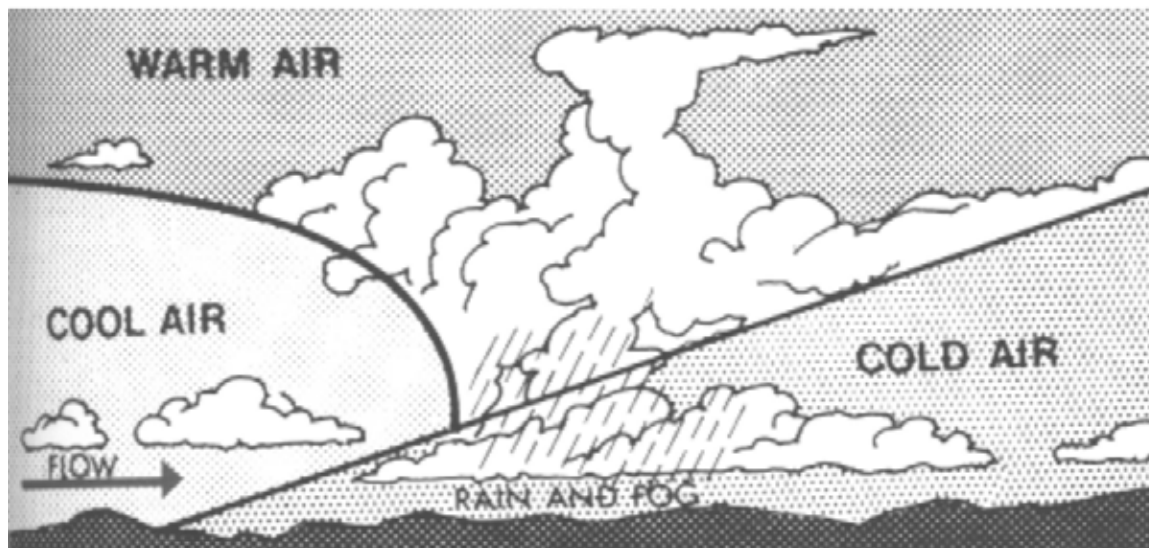

Figure H-3 Warm Occlusion

Note. From *From the Ground Up: Millennium Edition* (p. 143), by A. F. MacDonald and I. L. Peppler, 2000, Ottawa, ON: Aviation Publishers Co. Limited. Copyright 2000 by Aviation Publishers Co. Limited.

If the cold air is colder than the air it is overtaking (cold air advancing on cool air), the front is known as a cold occlusion.

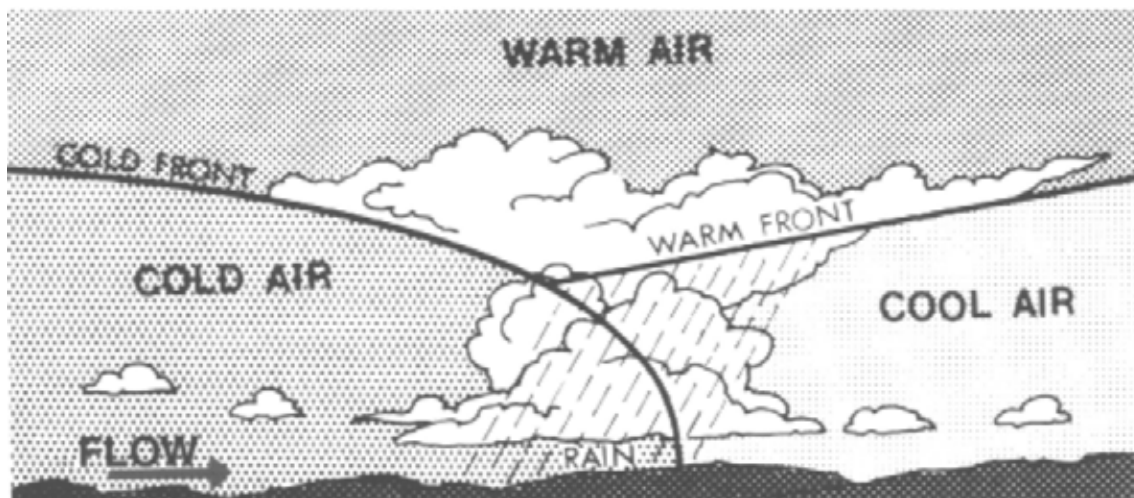

Figure H-4 Cold Occlusion

Note. From *From the Ground Up: Millennium Edition* (p. 143), by A. F. MacDonald and I. L. Peppler, 2000, Ottawa, ON: Aviation Publishers Co. Limited. Copyright 2000 by Aviation Publishers Co. Limited.

In both warm occlusions and cold occlusions, three air masses are present: a cool air mass, a cold air mass, and a warm air mass lying wedge-shaped over the colder air. The wedge-shaped mass of warm air is known as a trowal.

Both warm occlusions and cold occlusions have much the same characteristic as warm fronts, with low cloud and continuous rain. If the warm air is unstable, cumulonimbus clouds may develop; they are more likely to occur and bring about heavy turbulence, lightning, and icing in a cold occlusion.

THIS PAGE INTENTIONALLY LEFT BLANK

UPPER FRONTS

An upper cold front can form in two ways:

- A cold front advancing across the country may encounter a shallow layer of colder air resting on the surface. The cold front will then leave the ground and ride up over the colder, heavier air.

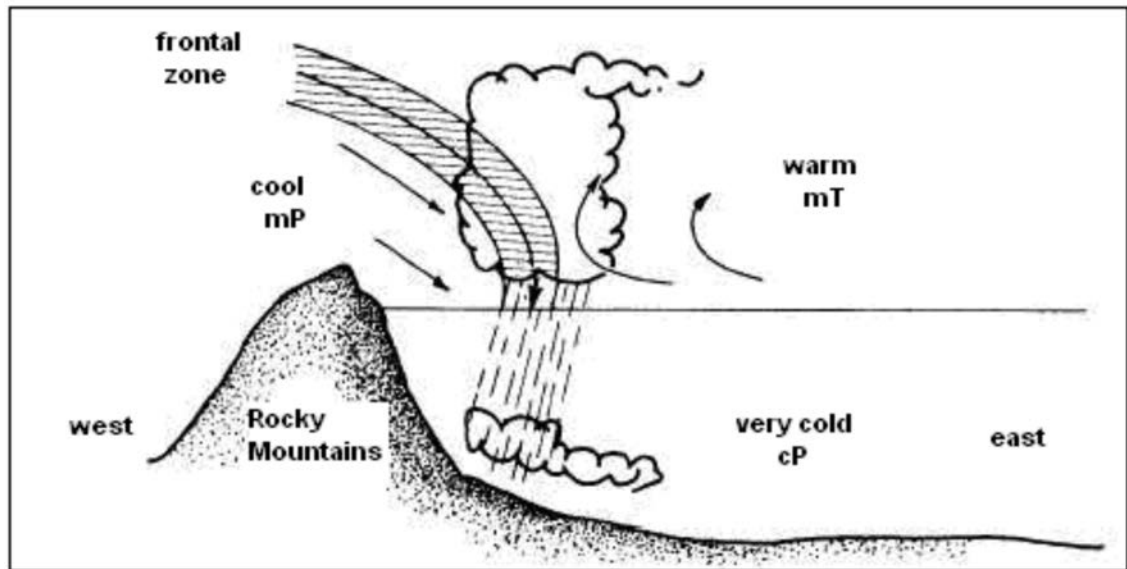

Figure I-1 Upper Cold Front

Note. From Integrated Publishing, *Aerographer / Meteorology*, Copyright 2003 by Integrated Publishing. Retrieved October 20, 2008, from http://www.tpub.com/content/aerographer/14312/css/14312_121.htm

- The structure of the advancing cold front is such that the cold air forms a shallow layer for some distance along the ground in advance of the main body of cold air. This causes the frontal surface of the main mass of cold air to be very steep. The line along which the frontal surface steepens is also known as an upper cold front.

An upper warm front can form in two ways:

- An advancing warm front rides up over a layer of cold air trapped on the ground. A change of air mass is not experienced on the ground because the front passes overhead.
- The surface of the cold air that is retreating ahead of an advancing warm front is almost flat for some distance ahead of the surface front and then steepens abruptly. The line along which the surface of the retreating cold air steepens sharply is also called an upper warm front.

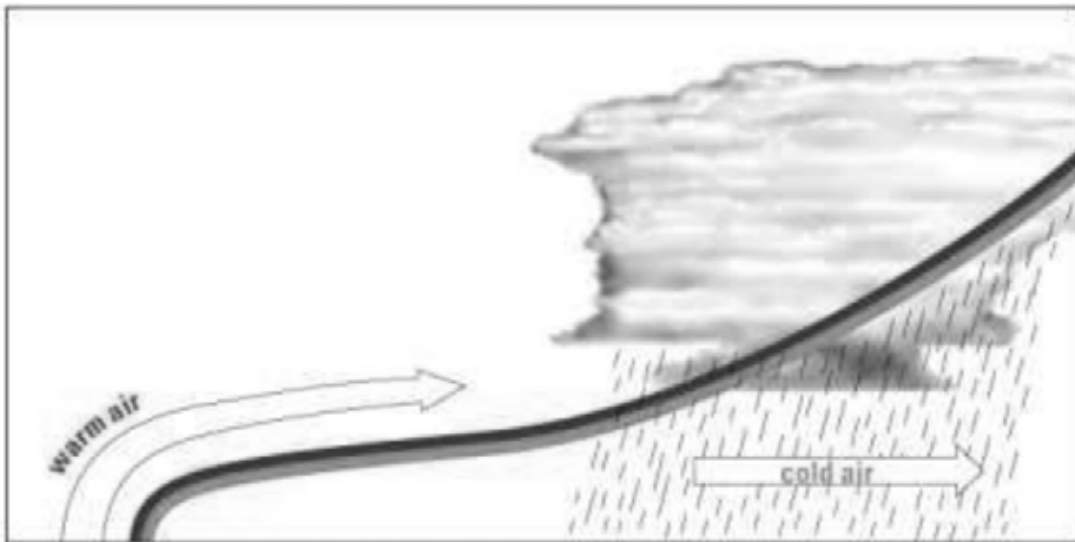

Figure I-2 Upper Warm Front

Note. From *Weather and Frontal Systems*, 2004, *Meteorological Services of Canada*. Copyright 2004 by Environment Canada. Retrieved October 20, 2008, from http://www.qc.ec.gc.ca/meteo/Documentation/Temps_fronts_e.html

Weather in upper fronts can be particularly hazardous in winter. Similar to warm fronts, rain from the warmer air falls through the layer of cold air on the surface causing freezing rain and icing conditions.

COLD FRONT

DEFINITION:

ASSOCIATED WEATHER:

INTERESTING FACTS:

DIAGRAM:



WARM FRONT

DEFINITION:

ASSOCIATED WEATHER:

INTERESTING FACTS:

DIAGRAM:

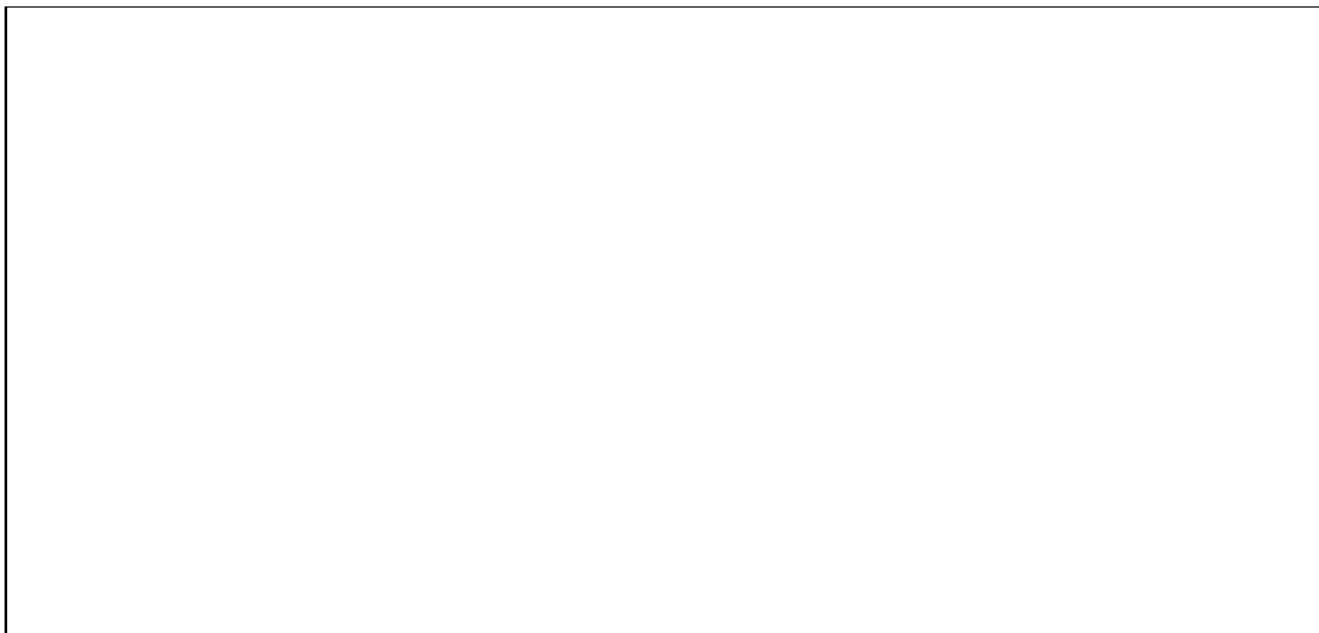

STATIONARY FRONT

DEFINITION:

ASSOCIATED WEATHER:

INTERESTING FACTS:

DIAGRAM:

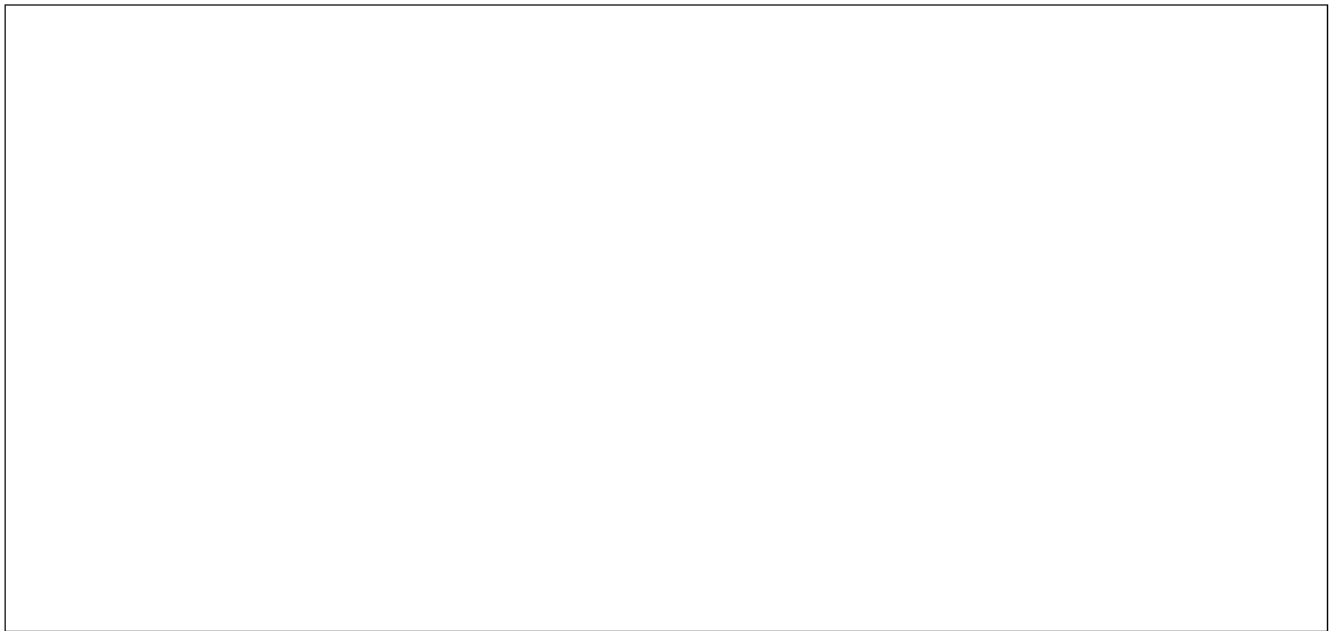

OCCLUDED FRONTS

DEFINITION OF WARM OCCLUSION:

DEFINITION OF COLD OCCLUSION:

ASSOCIATED WEATHER:

INTERESTING FACTS:

DIAGRAM:

UPPER FRONTS

UPPER COLD FRONT FORMATION:

1.

2.

UPPER WARM FRONT FORMATION:

1.

2.

ASSOCIATED WEATHER:

DIAGRAM:



THIS PAGE INTENTIONALLY LEFT BLANK



**ROYAL CANADIAN AIR CADETS
PROFICIENCY LEVEL FOUR
INSTRUCTIONAL GUIDE**



SECTION 3

EO C436.01 – EXPLAIN FOG

Total Time:

30 min

PREPARATION

PRE-LESSON INSTRUCTIONS

Resources needed for the delivery of this lesson are listed in the lesson specification located in A-CR-CCP-804/PG-001, *Proficiency Level Four Qualification Standard and Plan*, Chapter 4. Specific uses for said resources are identified throughout the instructional guide within the TP for which they are required.

Review the lesson content and become familiar with the material prior to delivering the lesson.

Acquire jars, strainers, and oven mitts (1 pair per group) for each group in TP 1.

Obtain three or four ice cubes for each group for TP 1.

Use a kettle(s) to boil water for each group for TP 1.

Prepare slides or handouts located at Attachment A.

PRE-LESSON ASSIGNMENT

Nil.

APPROACH

An in-class activity was chosen for this lesson as it is an interactive way to present the formation and types of fog.

INTRODUCTION

REVIEW

Nil.

OBJECTIVES

By the end of this lesson the cadet shall be expected to explain fog.

IMPORTANCE

Fog is one of the most common and persistent weather hazards encountered in aviation which impedes a pilot's visibility. Being able to explain fog provides knowledge for potential instructional duties and is part of the fundamentals that cadets pursuing future aviation training will require.

Teaching Point 1

Have the cadets perform an experiment to illustrate the formation of fog.

Time: 10 min

Method: In-Class Activity

ACTIVITY

OBJECTIVE

The objective of this activity is to have the cadet demonstrate how fog forms.

RESOURCES

- Glass jars,
- Strainers,
- Oven mitts,
- Kettle,
- Water,
- Rubbing alcohol, and
- Ice cubes.

ACTIVITY LAYOUT

Nil.

ACTIVITY INSTRUCTIONS

1. Divide the cadets into groups of two to four.
2. Use a kettle to boil water for each group.
3. Distribute resources to each group.
4. Briefly explain the steps of the experiment below and have the cadets make a hypothesis regarding the outcome.
5. Have each group perform the following experiment:
 - a. Fill the jar completely with hot water and let it stand for one minute.
 - b. Using oven mitts pour out all but 3 cm of water from the jar.
 - c. Add three to four drops of rubbing alcohol to water.
 - d. Put the strainer over the top of the jar.
 - e. Place three or four ice cubes in the strainer.
 - f. Observe the results.
6. Give the groups time to discuss what they have observed.
7. Ask the cadets to provide an explanation of what has happened.



The warm, moist air is cooled by the ice cubes to a temperature below its dewpoint, causing the water vapour to condense and form a cloud. A cloud in contact with the ground is called fog.

Fog can also form when the dewpoint is raised to the air temperature through the addition of water vapour.

The following are the ideal conditions for the formation of fog:

- an abundance of condensation nuclei,
- high relative humidity,
- a small temperature dewpoint spread, and
- some cooling process to initiate condensation.

Fog is usually dissipated by heating from below as sunlight filters down through the fog layer.

SAFETY

- Warn the cadets the water is hot and may cause burns.
- Ensure the cadets use oven mitts and caution when pouring the hot water.

CONFIRMATION OF TEACHING POINT 1

The cadets' participation in the activity will serve as the confirmation of this TP.

Teaching Point 2

Conduct an in-class activity to explain types of fog.

Time: 15 min

Method: In-Class Activity

ACTIVITY

OBJECTIVE

The objective of this activity is to have the cadets explain types of fog.

RESOURCES

- Flip chart paper,
- Flip chart markers, and
- *From the Ground Up: Millennium Edition.*

ACTIVITY LAYOUT

Arrange the classroom for group work.

ACTIVITY INSTRUCTIONS

1. Divide the cadets into four groups.
2. Assign a leader in each group. The group leader will be responsible for assigning tasks to fellow cadets. Each group will need a recorder and at least one presenter.
3. Distribute flip chart paper and flip chart markers to each group.
4. Assign each group one of the following:
 - a. radiation fog,
 - b. advection fog,
 - c. upslope fog and steam fog, and
 - d. precipitation-induced fog and ice fog.
5. Have each group prepare a two-minute presentation on their type of fog using *From the Ground Up: Millennium Edition*, p. 147 as a reference.



Encourage the cadets to be creative and draw diagrams of the formation of their types of fog.

6. Have each group deliver their presentation.



Give handouts to each cadet or show slides located at Attachment A.

7. Answer any questions about the types of fog.



The types of fog can easily be remembered using the mnemonic "RAIS UP", as in "RAIS UP da roof".

SAFETY

Nil.

CONFIRMATION OF TEACHING POINT 2

QUESTIONS:

- Q1. What conditions are ideal for the formation of radiation fog?
- Q2. The drifting of warm, moist air over a colder land or sea surface causes which type of fog?
- Q3. Explain the formation of steam fog.

ANTICIPATED ANSWERS:

- A1. Light wind, clear skies, and an abundance of condensation nuclei.
- A2. Advection fog.
- A3. Steam fog is formed when cold air passes over a warm water surface. Evaporation of the water into the cold air occurs until the cold air becomes saturated. The excess water vapour condenses as fog.
-

END OF LESSON CONFIRMATION**QUESTIONS:**

- Q1. What is fog?
- Q2. What are the two basic ways in which fog is formed?
- Q3. What type of fog is associated mostly with warm fronts?

ANTICIPATED ANSWERS:

- A1. Fog is a cloud in contact with the ground.
- A2. Fog is formed in the following ways:
- warm, moist air is cooled to a temperature below its dewpoint, causing the water vapour to condense and form a cloud; or
 - the dewpoint is raised to the air temperature through the addition of water vapour.
- A3. Precipitation-induced fog.
-

CONCLUSION**HOMEWORK / READING / PRACTICE**

Nil.

METHOD OF EVALUATION

Nil.

CLOSING STATEMENT

A good lookout is one of the most important aspects of airmanship when flying under Visual Flight Rules, making visibility from the cockpit a key factor in flight. Fog is one of the most common and persistent weather hazards encountered in aviation which impedes a pilot's visibility. An understanding of fog and the conditions under which it forms is essential for future aviation training.

INSTRUCTOR NOTES / REMARKS

Cadets who are qualified Advanced Aviation may assist with this instruction.

REFERENCES

C3-116 ISBN 0-9680390-5-7 MacDonald, A. F., & Pepler, I. L. (2000). *From the ground up: Millennium edition*. Ottawa, ON: Aviation Publishers Co. Limited.

C3-200 Weather Wiz Kids. (2008). *Make fog*. Retrieved September 26, 2008, from <http://www.weatherwizkids.com/fog.htm>

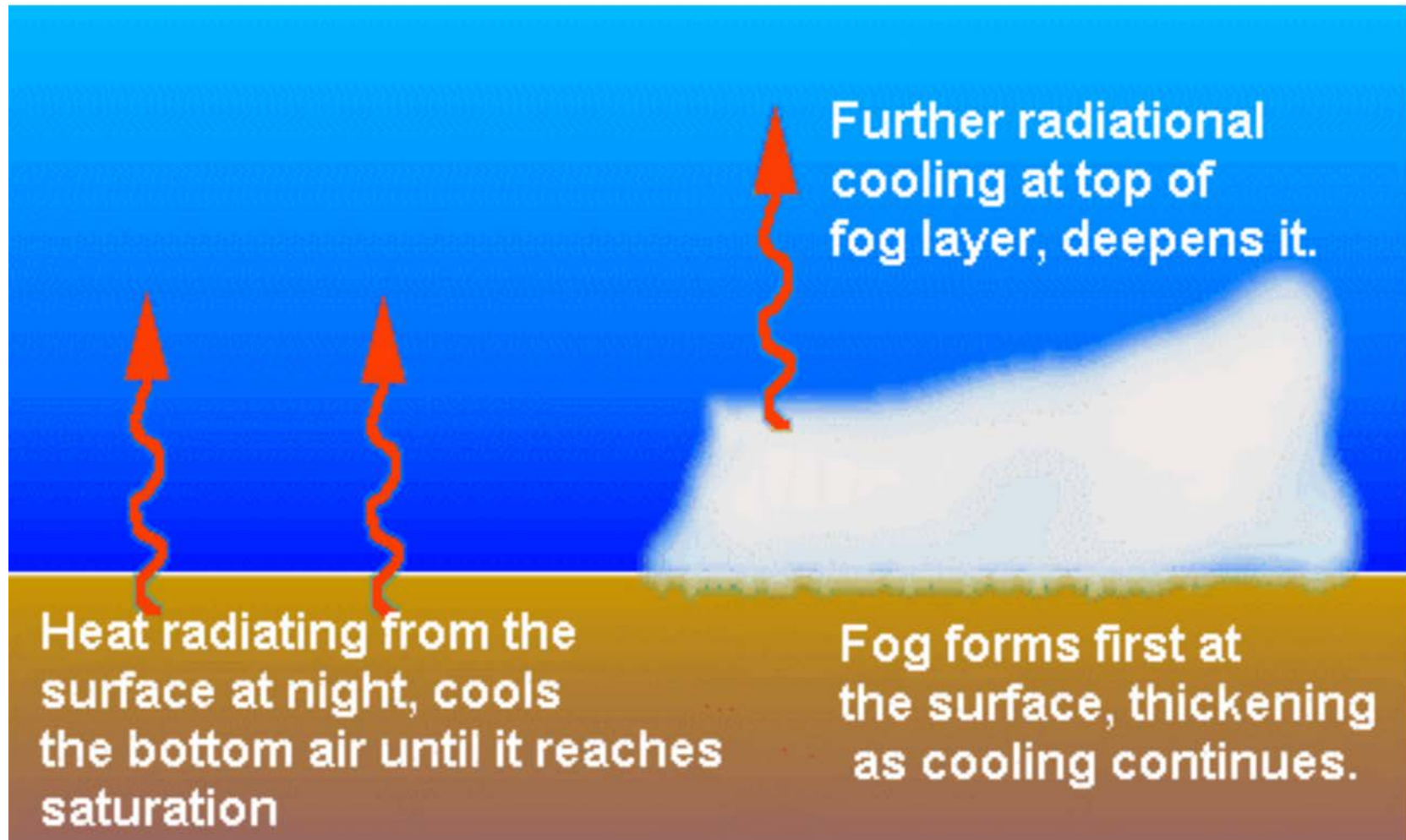

Figure A-1 Radiation Fog

Note. From The Fog Rolls In, 2002, *Weather Almanac for September*. Copyright 2002 by The Weather Doctor.
Retrieved March 2, 2009, from <http://www.islandnet.com/~see/weather/almanac/arc2002/alm02sep.htm>

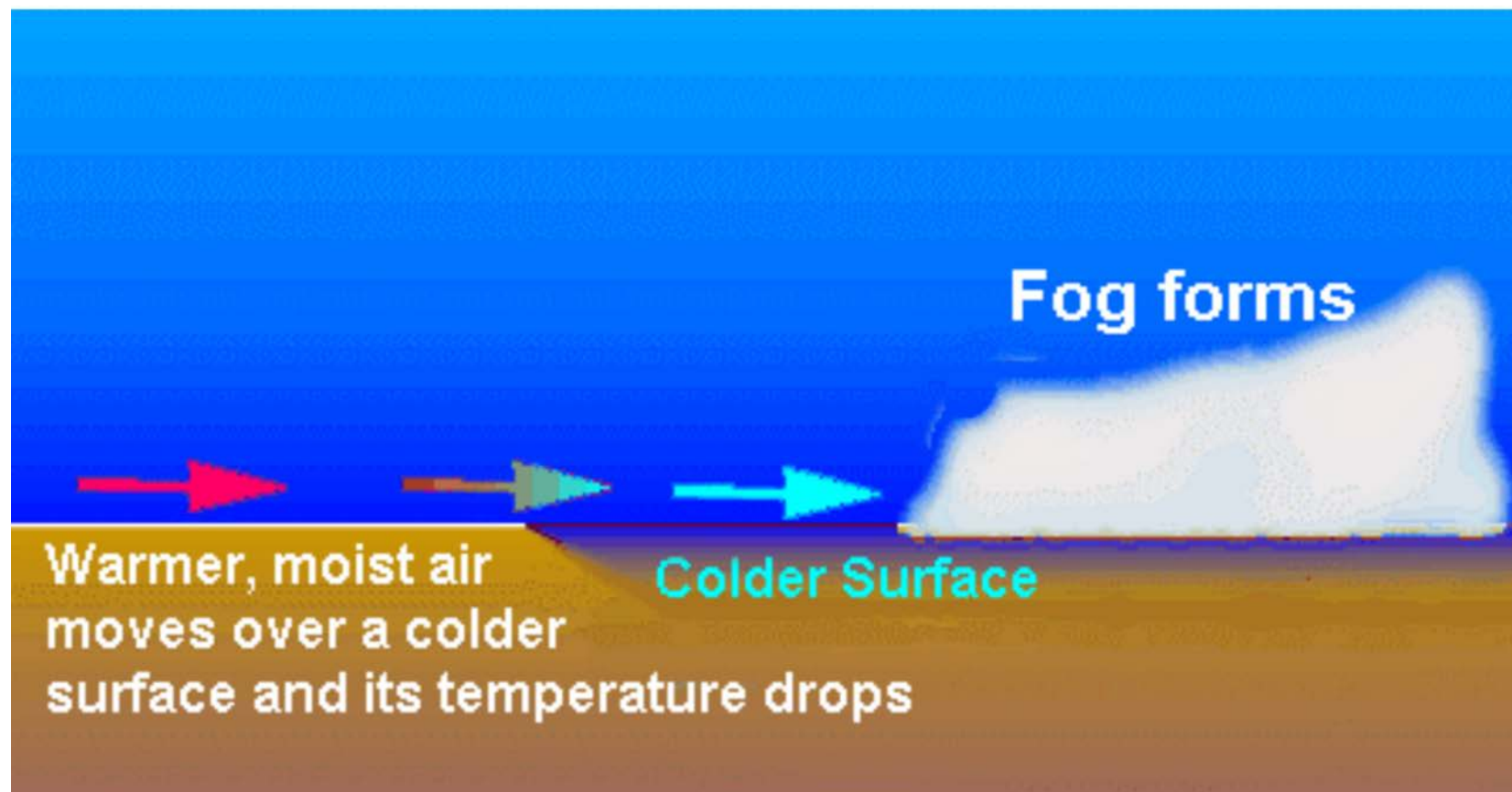

Figure A-2 Advection Fog

Note. From The Fog Rolls In, 2002, *Weather Almanac for September*. Copyright 2002 by The Weather Doctor.
Retrieved March 2, 2009, from <http://www.islandnet.com/~see/weather/almanac/arc2002/alm02sep.htm>

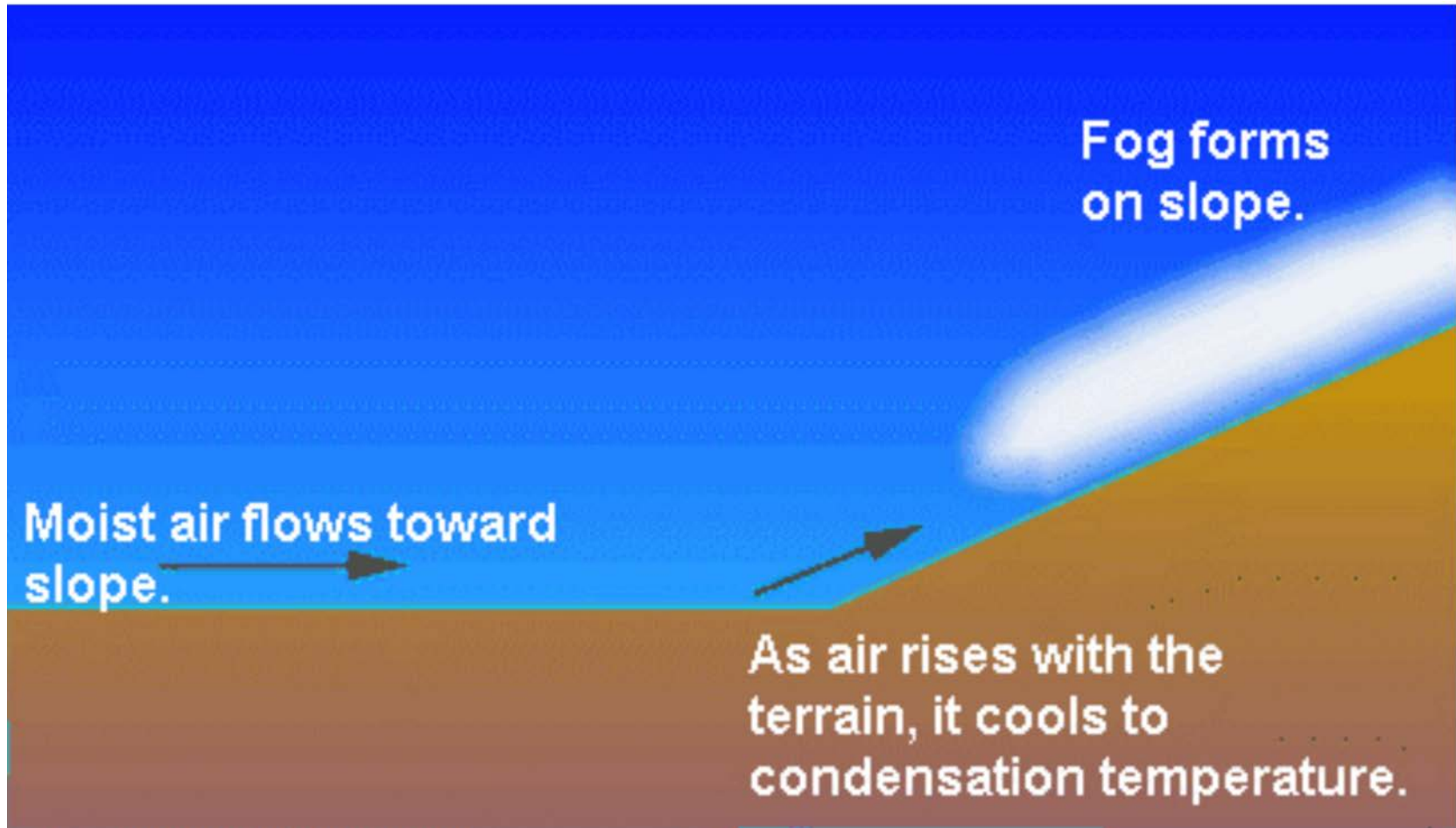

Figure A-3 Upslope Fog

Note. From The Fog Rolls In, 2002, *Weather Almanac for September*. Copyright 2002 by The Weather Doctor.
Retrieved March 2, 2009, from <http://www.islandnet.com/~see/weather/almanac/arc2002/alm02sep.htm>

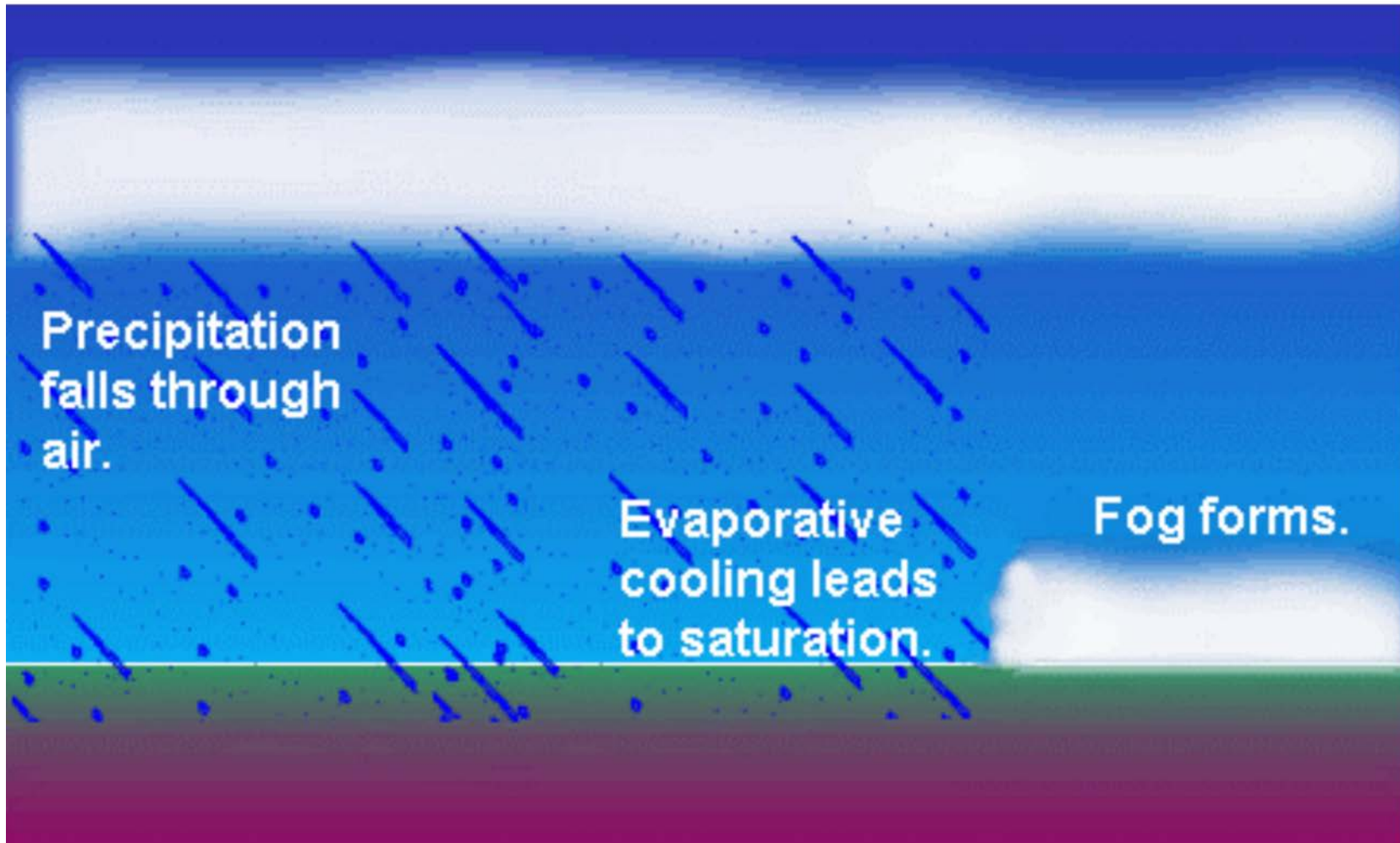

Figure A-4 Precipitation-Induced Fog

Note. From The Fog Rolls In, 2002, *Weather Almanac for September*. Copyright 2002 by The Weather Doctor.
Retrieved March 2, 2009, from <http://www.islandnet.com/~see/weather/almanac/arc2002/alm02sep.htm>



**ROYAL CANADIAN AIR CADETS
PROFICIENCY LEVEL FOUR
INSTRUCTIONAL GUIDE**



SECTION 4

EO C436.02 – DESCRIBE SEVERE WEATHER CONDITONS

Total Time:	30 min
-------------	--------

PREPARATION

PRE-LESSON INSTRUCTIONS

Resources needed for the delivery of this lesson are listed in the lesson specification located in A-CR-CCP-804/PG-001, *Proficiency Level Four, Qualification Standard and Plan*, Chapter 4. Specific uses for said resources are identified throughout the instructional guide within the TP for which they are required.

Review the lesson content and become familiar with the material prior to delivering the lesson.

Prepare slides located at Attachment A.

PRE-LESSON ASSIGNMENT

Nil.

APPROACH

An interactive lecture was chosen for this lesson to introduce the cadet to severe weather conditions and to generate interest.

INTRODUCTION

REVIEW

Nil.

OBJECTIVES

By the end of this lesson the cadet shall be expected to describe severe weather conditions.

IMPORTANCE

It is important for cadets to describe severe weather conditions as knowledge of this material is essential for future aviation training and potential instructional duties at the squadron.

Teaching Point 1

Describe thunderstorms.

Time: 10 min

Method: Interactive Lecture

THUNDERSTORMS

Formation

The requirements for the formation of a thunderstorm are the following:

- unstable air,
- high moisture content, and
- some form of lifting agent.

The intensity of these conditions is the difference between a harmless cumulus cloud and a violent thunderstorm. Such unstable atmospheric conditions may be brought about when air is heated from below (convection), forced to ascend the side of a mountain (orographic lift), or lifted over a frontal surface (frontal lift).



Show slide of Figure A-1.

There are three distinct stages of a thunderstorm:

1. cumulus,
2. mature, and
3. dissipating.

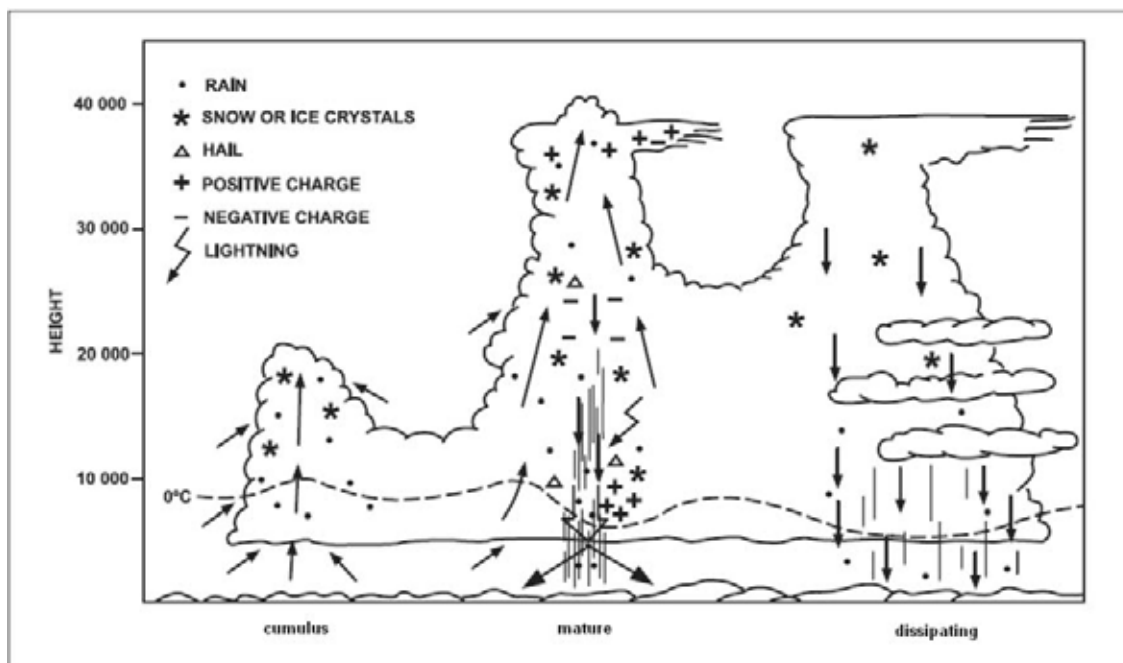

Figure 1 Stages of a Thunderstorm

Note. From *Air Command Weather Manual* (p. 15-2), 2004, Winnipeg, MB: Wing Publishing Office. Copyright 2004 by Her Majesty the Queen in Right of Canada.

Every thunderstorm begins as a cumulus cloud. Strong updrafts, due to the unstable air and lifting agent cause the cloud to build rapidly into a towering cumulus and then cumulonimbus cloud. There is usually no precipitation in this stage as the water droplets and ice crystals are kept suspended in the cloud by the strong updrafts.

In the mature stage, the cumulonimbus cloud may reach heights up to 60 000 feet, with updrafts of 6 000 feet per minute and downdrafts of 2 000 feet per minute. Precipitation, violent turbulence, and thunder and lightning are all associated with thunderstorms in their mature stage.

The precipitation tends to cool the lower region of the cloud causing the thunderstorm cell to dissipate. The downdrafts spread throughout the whole cell except for a small portion at the top where updrafts still occur. The rainfall gradually ceases and the top of the cell spreads out into an anvil shape.

Dangers



Show slide of Figure A-2.

The dangers of flying in or close to a thunderstorm are:

- severe turbulence,
- lightning,
- hail,
- icing,

- unreliable altimeter readings due to rapid changes in pressure,
- strong wind gusts, and
- heavy rain.

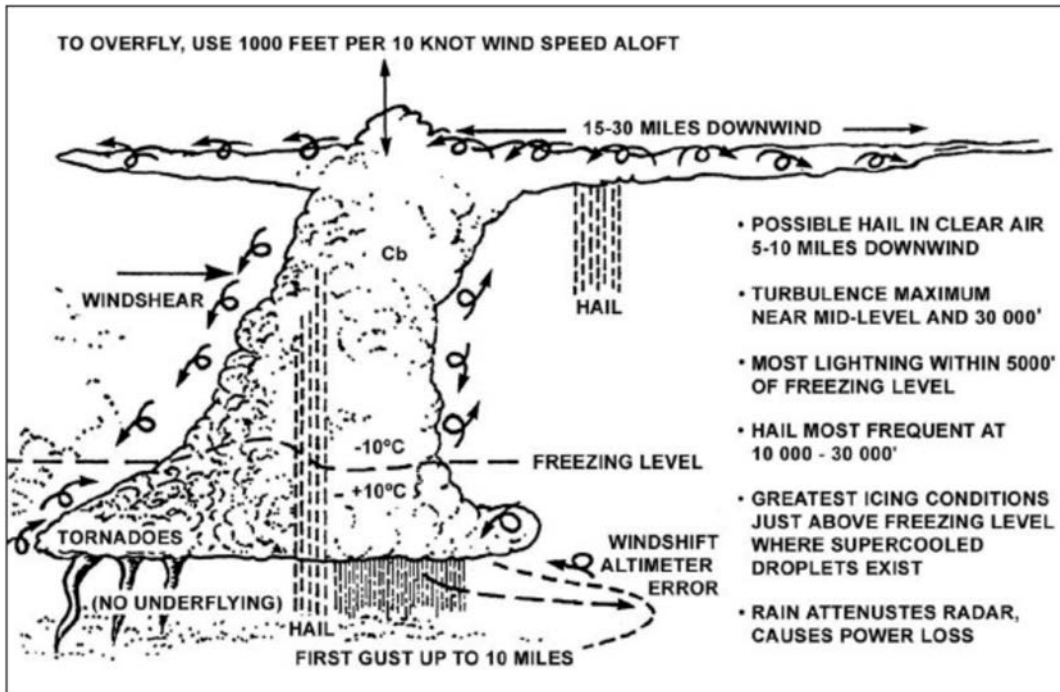

Figure 2 Thunderstorm Dangers

Note. From *Air Command Weather Manual* (p. 15-2), 2004, Winnipeg, MB: Wing Publishing Office. Copyright 2004 by Her Majesty the Queen in Right of Canada.

Avoidance

Stay at least five miles away from a thunderstorm. When flying around a thunderstorm, fly to the right side of it as the wind is circulating counter-clockwise around the low pressure area. Never fly through a thunderstorm in a light aircraft.

CONFIRMATION OF TEACHING POINT 1

QUESTIONS:

- Q1. What are the requirements for the formation of a thunderstorm?
- Q2. In which stage of a thunderstorm will the top of the cumulonimbus cloud take on an anvil shape?
- Q3. What are three of the dangers associated with thunderstorms?

ANTICIPATED ANSWERS:

- A1. Unstable air, high moisture content, and some form of lifting agent.
- A2. The dissipating stage.

A3. Cadets may give any three of the following answers:

- severe turbulence,
- lightning,
- hail,
- icing,
- unreliable altimeter readings due to rapid changes in pressure,
- strong wind gusts, and
- heavy rain.

Teaching Point 2

Describe icing.

Time: 5 min

Method: Interactive Lecture

ICING

When an airplane flies at an altitude where the outside air temperature is at or below freezing and strikes a supercooled water droplet, the droplet will freeze and adhere to the airplane. This can occur in cloud, freezing rain, or freezing drizzle. Icing can also occur in clear air through sublimation.

Types of Icing

There are three main types of icing:

- clear ice,
- rime ice, and
- frost.



Show slide of Figure A-3.

Clear ice is a heavy coating of glassy ice which forms when flying in dense cloud or freezing rain. It forms when only a small part of the supercooled water droplet freezes on impact, with the rest of the droplet spreading out and freezing slowly. Clear ice is the most dangerous form of icing because of the following:

- loss of lift due to the altered camber of the wing,
- increase in drag due to the enlarged profile area of the wings,
- increase in weight due to the large mass of ice, and
- the vibration caused by the unequal loading on the wings and propeller blades.

Rime ice is an opaque (milky white) deposit of ice. Rime ice forms when the aircraft skin is at a temperature below zero degrees Celsius, causing the water droplet to freeze completely on contact. Although rime ice is light, it is dangerous due to the aerodynamic alteration of the wing camber and the interference it causes with the carburetor and pitot static system.

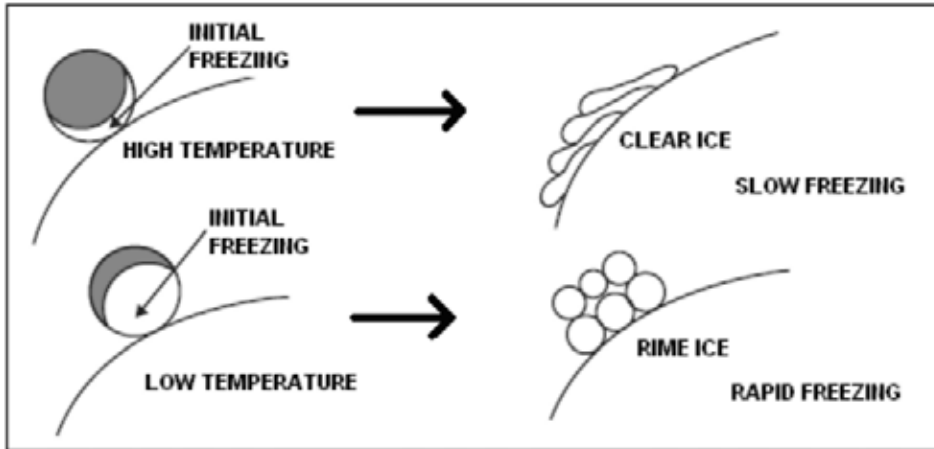

Figure 3 Clear Ice and Rime Ice

Note. From *Air Command Weather Manual* (p. 9-4), 2004, Winnipeg, MB: Wing Publishing Office. Copyright 2004 by Her Majesty the Queen in Right of Canada.

Frost is a white semi-crystalline form of icing which forms in clear air by the process of sublimation. It generally forms on two occasions:

- when a cold aircraft enters warmer and damper air during a steep descent; and
- when an aircraft parked outside on a clear cold night cools by radiation to a temperature below that of the surrounding air.

Frost should be removed before takeoff as it will reduce lift and increase the stall speed of the aircraft.



Show slide of Figure A-4.

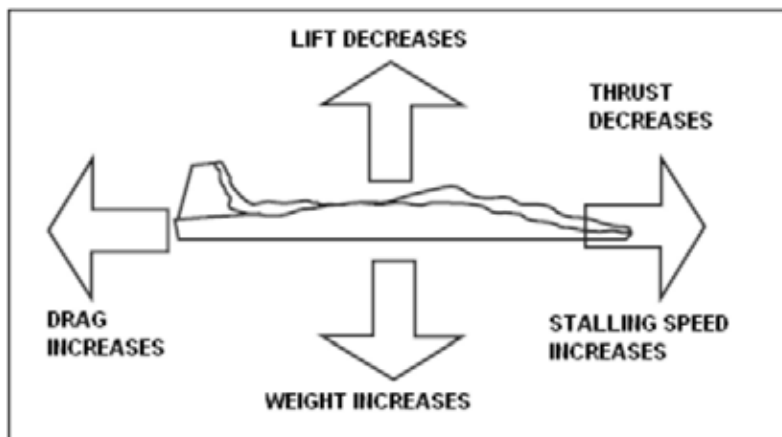

Figure 4 Effects of Icing

Note. From *Air Command Weather Manual* (p. 9-1), 2004, Winnipeg, MB: Wing Publishing Office. Copyright 2004 by Her Majesty the Queen in Right of Canada.

Protection From Icing

Many modern airplanes are fitted with various systems designed to prevent ice from forming or to remove ice after it has formed. Three of these systems are:

- fluids,
- rubber boots, and
- heating devices.

Fluids with a low freezing point are released over the blades of the propellers and the surfaces of the wings to prevent icing.



Show slide of Figure A-5.

Rubber boots are membranes of rubber attached to the leading edges that can pulsate in such a way that ice is cracked and broken off after it has formed.

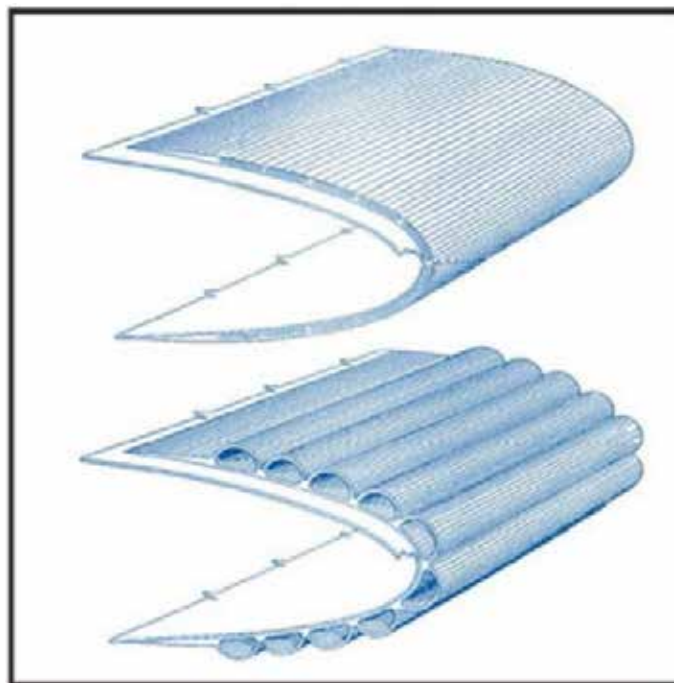

Figure 5 Rubber Boots

Note. From "Icing Conditions in Flight", *Pilot Friend*. Retrieved October 22, 2008, from http://www.pilotfriend.com/safe/safety/icing_conditions.htm

Heating vulnerable areas with hot air from the engine or special heaters prevents the buildup of ice.

CONFIRMATION OF TEACHING POINT 2

QUESTIONS:

- Q1. How can a pilot tell the difference between clear ice and rime ice?
- Q2. How does frost form?
- Q3. What are three methods of protection from icing?

ANTICIPATED ANSWERS:

- A1. Clear ice is glassy while rime ice is opaque.
- A2. Frost forms through sublimation.
- A3. Fluids, rubber boots, and heating devices.

Teaching Point 3

Describe types of turbulence.

Time: 10 min

Method: Interactive Lecture

TYPES OF TURBULENCE

Turbulence is an irregular motion of the air resulting from eddies and vertical currents. It is one of the most unpredictable of all the weather phenomena.

There are four types of turbulence:

- mechanical turbulence,
- thermal turbulence,
- frontal turbulence, and
- wind shear.



Show slides of Figures A-6 and A-7.

Mechanical Turbulence

Mechanical turbulence is caused by friction between the air and the ground. The intensity of mechanical turbulence depends on the strength of the surface wind, the nature of the terrain, and the stability of the air. Strong winds, rough terrain, and very unstable air create greater turbulence. Mountain waves produce some of the most severe mechanical turbulence.

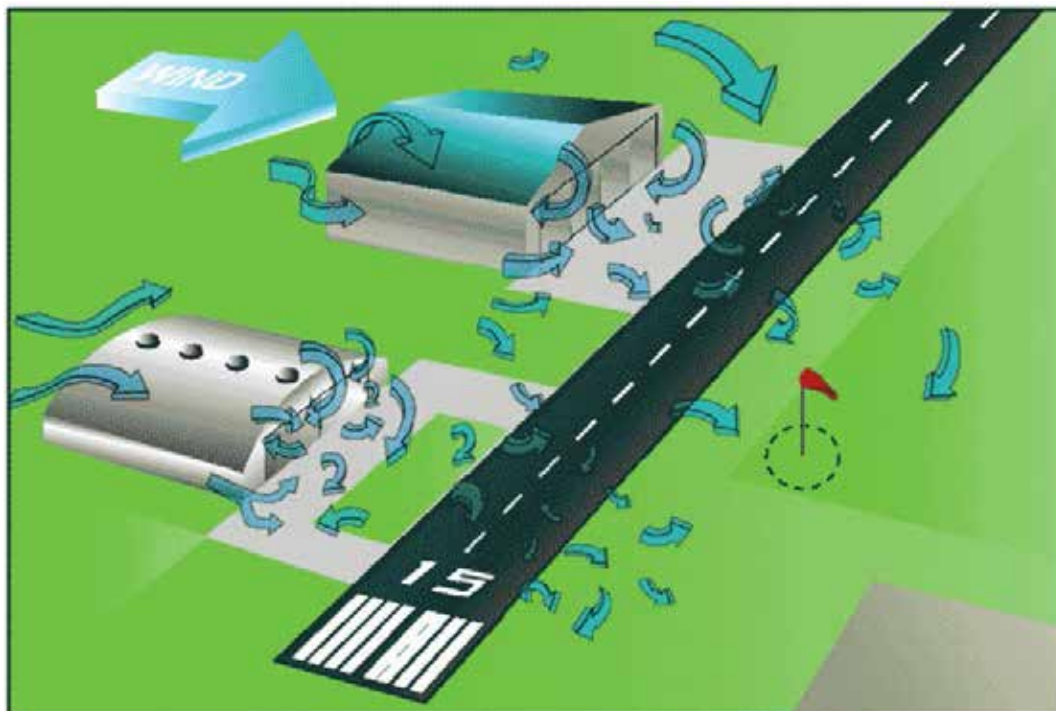

Figure 6 Mechanical Turbulence

Note. From "Aviation Weather", *Free Online Private Pilot Ground School*. Retrieved October 22, 2008, from <http://www.free-online-private-pilot-ground-school.com/Aviation-Weather-Principles.html>

Thermal Turbulence

Thermal turbulence is caused by the uneven heating of the ground. Certain surfaces, such as plowed fields and pavement, are heated more rapidly than others, such as grass-covered fields and water. This causes isolated convective currents that are responsible for bumpy conditions as an airplane flies in and out of them. These convective currents can have a pronounced effect on the flight path of an airplane approaching a landing area, causing it to either overshoot or undershoot.



Rising convective currents are commonly referred to as "thermals" or "lift". Glider pilots use their knowledge of the terrain to find thermals and soar for extended periods of time. They also learn to recognize and avoid sinking convective currents (commonly known as "sink").

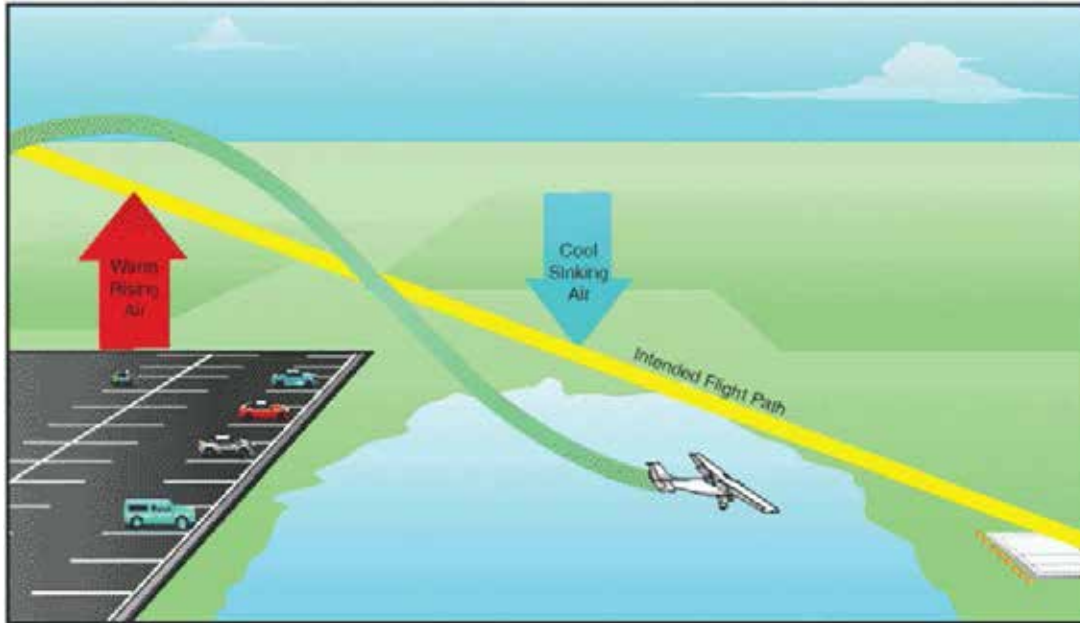

Figure 7 Thermal Turbulence

Note. From "Aviation Weather", *Free Online Private Pilot Ground School*. Retrieved October 22, 2008, from <http://www.free-online-private-pilot-ground-school.com/Aviation-Weather-Principles.html>

Frontal Turbulence

Frontal turbulence is caused by the lifting of warm air by the sloping frontal surface and the friction between the two opposing air masses. This turbulence is strongest in cold fronts, especially when the warm air is moist and unstable.

Wind Shear

Wind shear is caused when there are significant changes in wind speed and direction with height.

CONFIRMATION OF TEACHING POINT 3

QUESTIONS:

- Q1. What causes mechanical turbulence?
- Q2. Name two examples of terrain that heat more rapidly than water.
- Q3. In which type of front is turbulence more pronounced?

ANTICIPATED ANSWERS:

- A1. Mechanical turbulence is caused by friction between the air and the ground.
- A2. A plowed field and pavement.
- A3. Cold front.

END OF LESSON CONFIRMATION**QUESTIONS:**

- Q1. What are the three stages of a thunderstorm?
- Q2. What are the three main types of icing?
- Q3. What are the four types of turbulence?

ANSWERS:

- A1. Cumulus, mature, and dissipating.
- A2. Clear ice, rime ice, and frost.
- A3. Mechanical turbulence, thermal turbulence, frontal turbulence, and wind shear.

CONCLUSION

HOMEWORK / READING / PRACTICE

Nil.

METHOD OF EVALUATION

Nil.

CLOSING STATEMENT

Severe weather conditions can adversely affect a flight and ruin a pilot's day. Knowing how to recognize and deal with these conditions is essential for future aviation training.

INSTRUCTOR NOTES / REMARKS

Cadets who are qualified Advanced Aviation may assist with this instruction.

REFERENCES

C3-116 ISBN 0-9680390-5-7 MacDonald, A. F., & Peppler, I. L. (2000). *From the ground up: Millennium edition*. Ottawa, ON: Aviation Publishers Co. Limited

THIS PAGE INTENTIONALLY LEFT BLANK

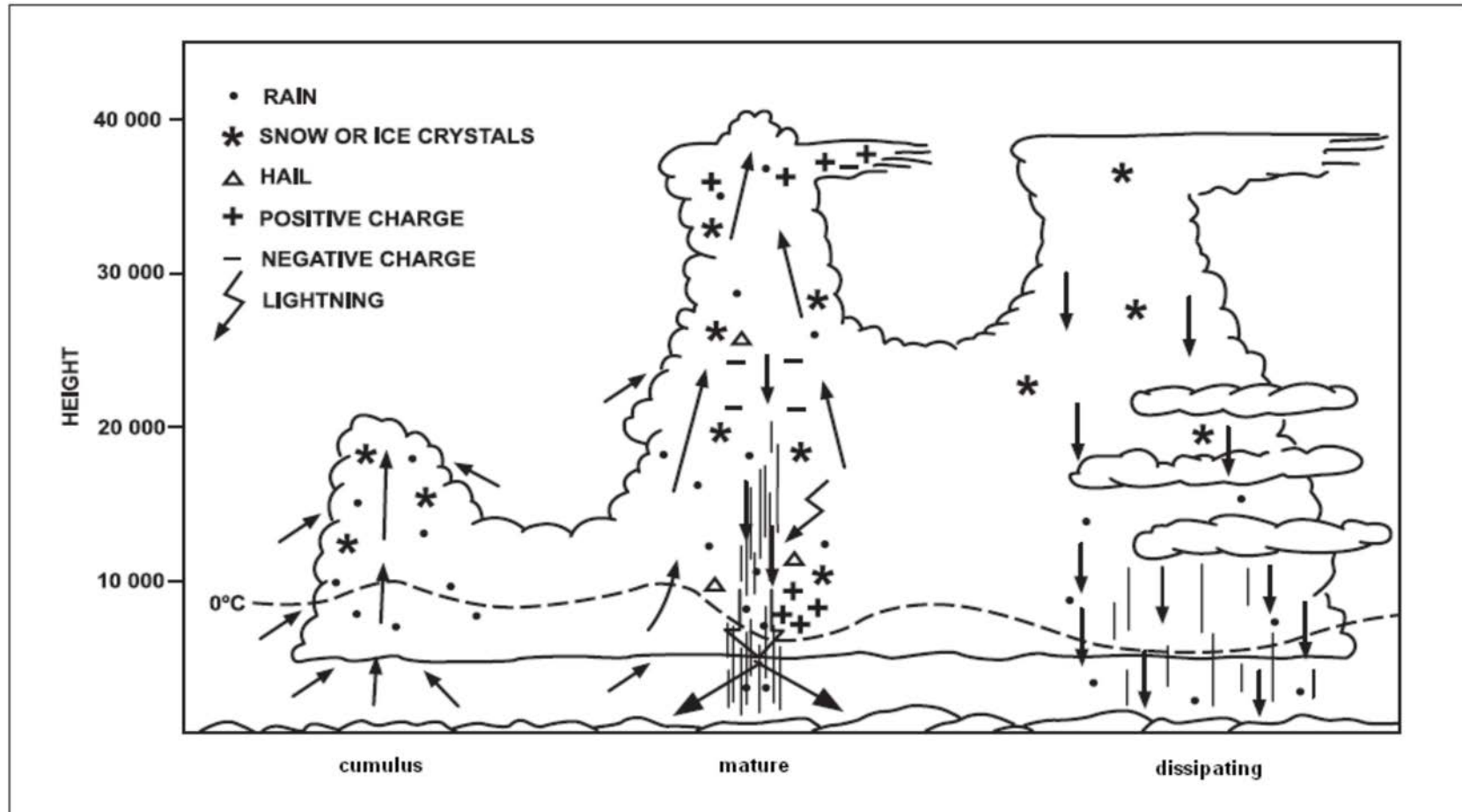

Figure A-1 Stages of a Thunderstorm

Note. From *Air Command Weather Manual* (p. 15-2), 2004, Winnipeg, MB: Wing Publishing Office. Copyright 2004 by Her Majesty the Queen in Right of Canada.

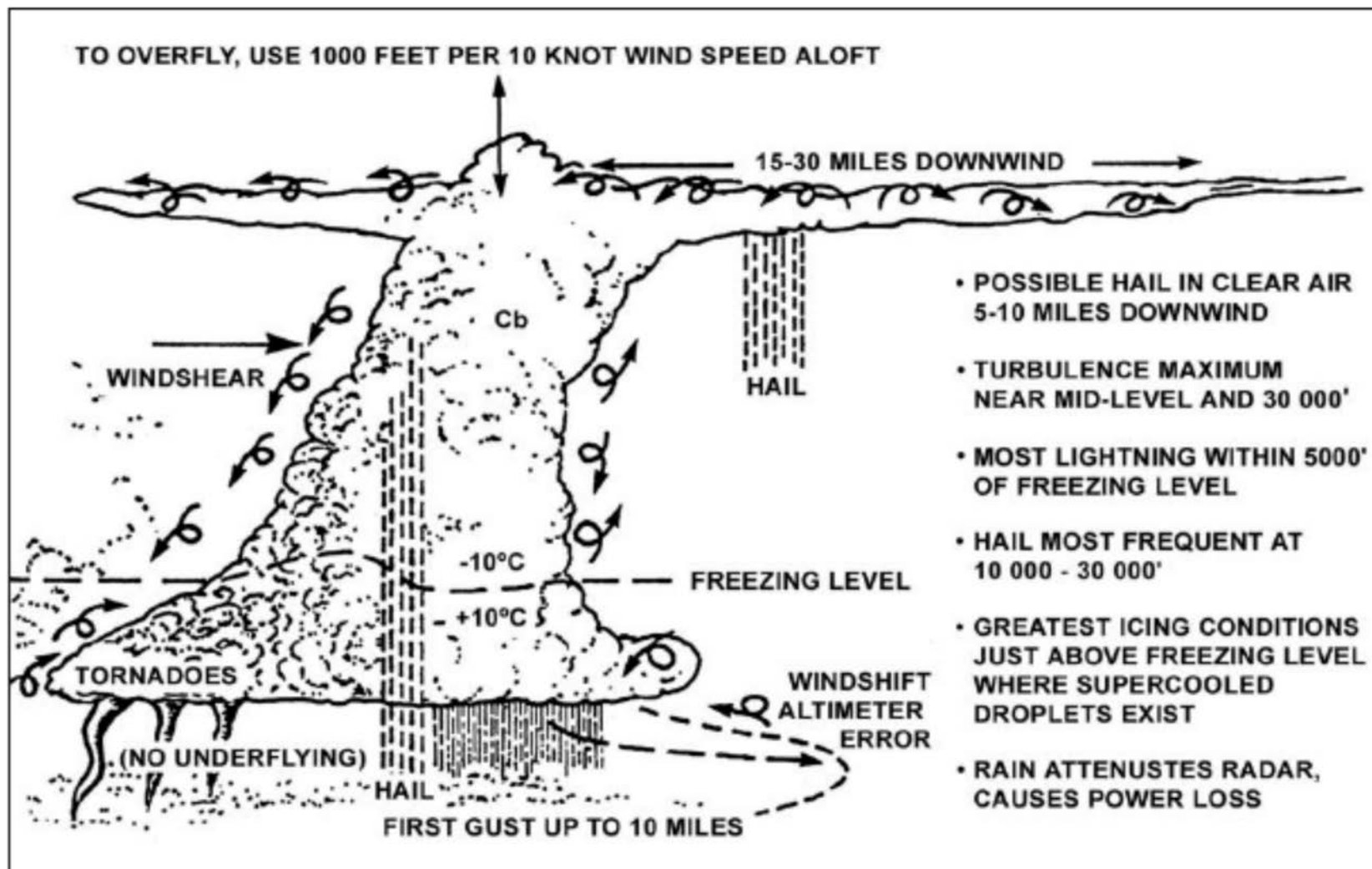

Figure A-2 Thunderstorm Dangers

Note. From *Air Command Weather Manual* (p. 15-2), 2004, Winnipeg, MB: Wing Publishing Office. Copyright 2004 by Her Majesty the Queen in Right of Canada.

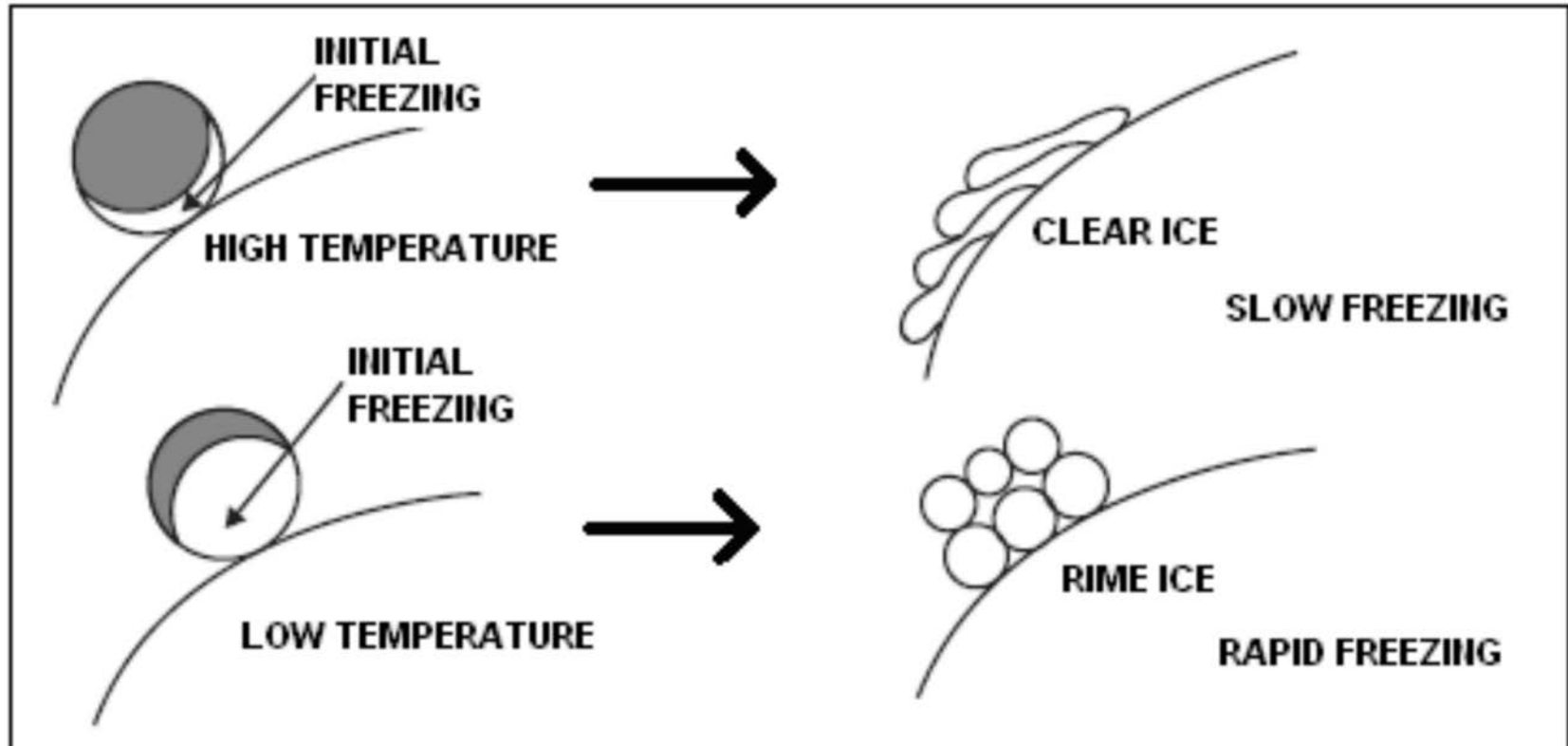

Figure A-3 Clear Ice and Rime Ice

Note. From *Air Command Weather Manual* (p. 9-4), 2004, Winnipeg, MB: Wing Publishing Office. Copyright 2004 by Her Majesty the Queen in Right of Canada.

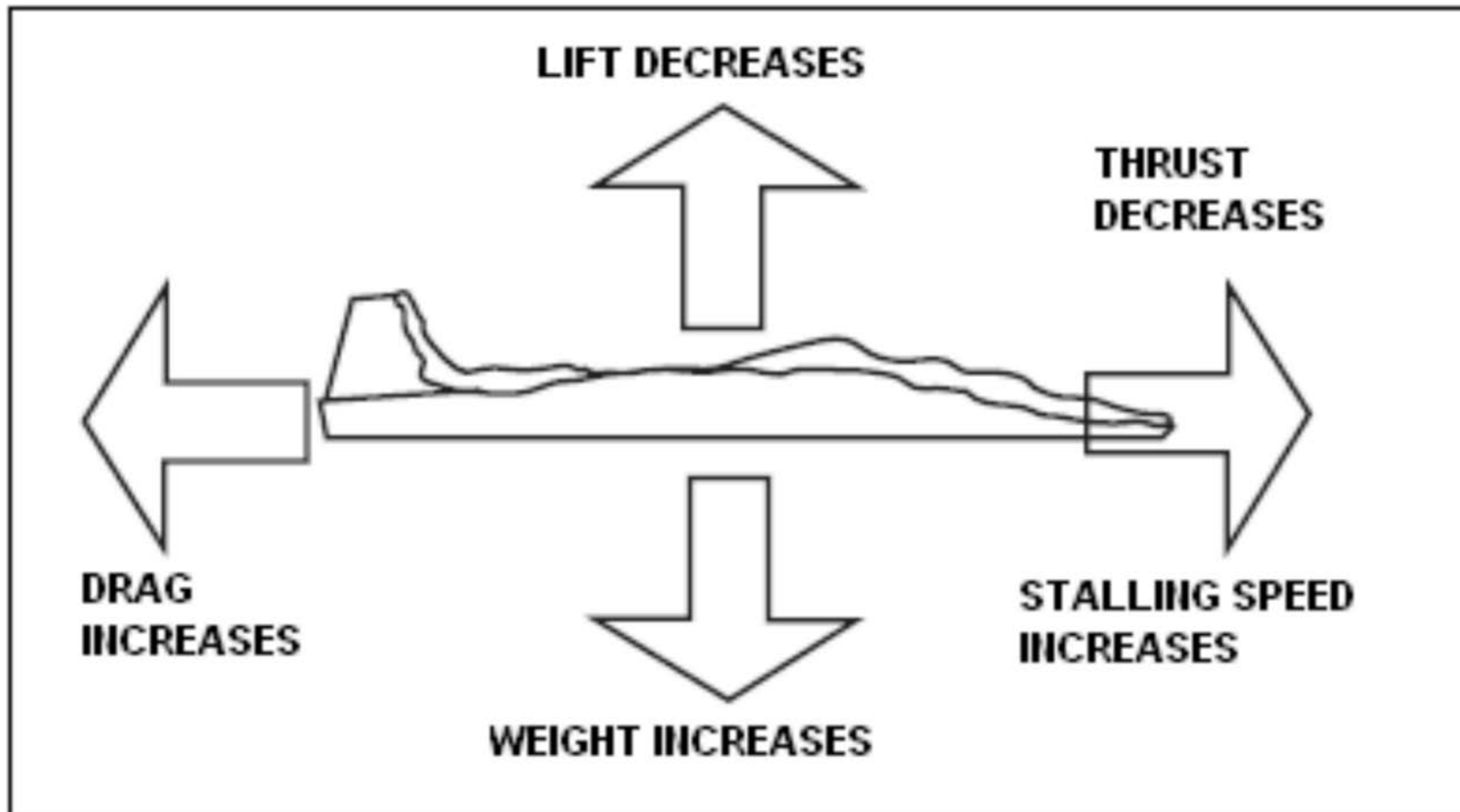

Figure A-4 Effects of Icing

Note. From *Air Command Weather Manual* (p. 9-1), 2004, Winnipeg, MB: Wing Publishing Office. Copyright 2004 by Her Majesty the Queen in Right of Canada.

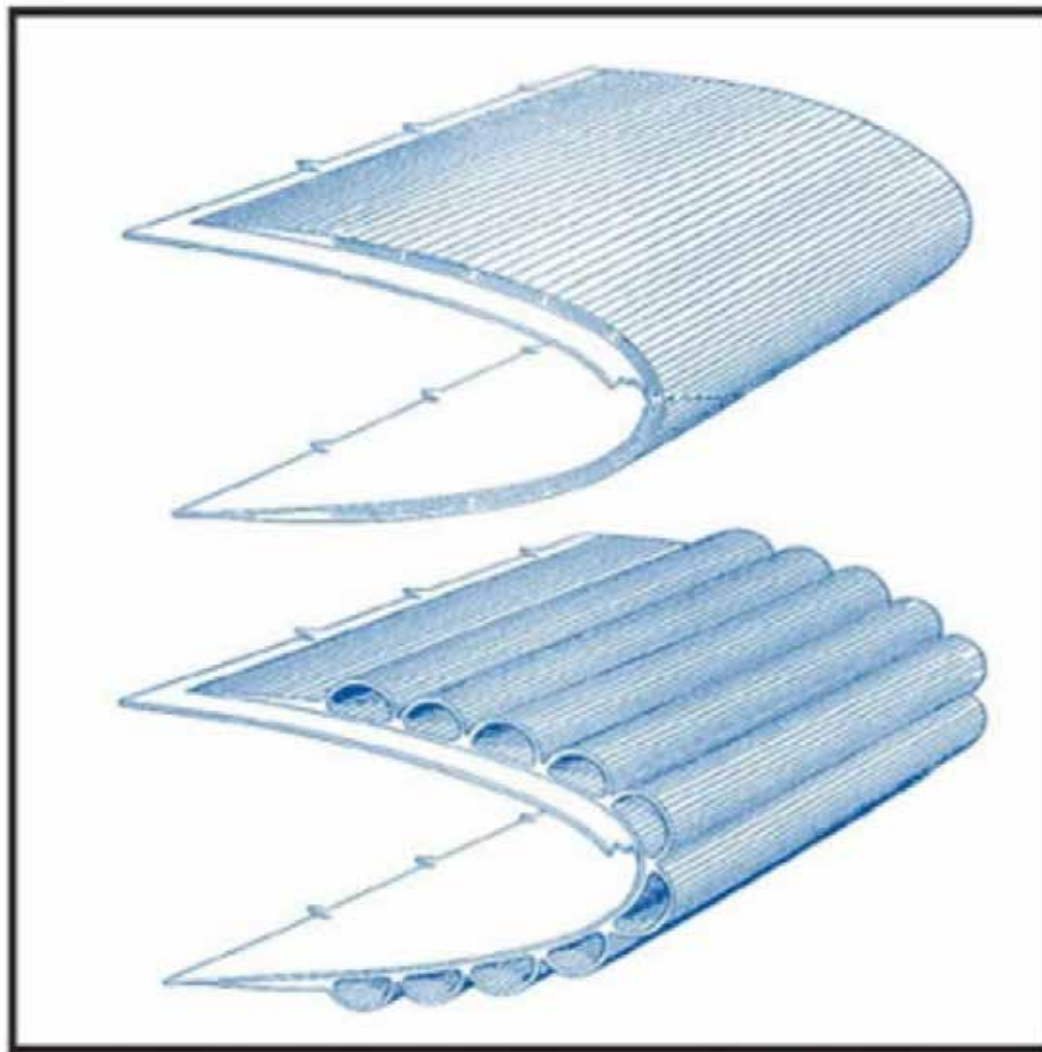

Figure A-5 Rubber Boots

Note. From "Icing Conditions in Flight", *Pilot Friend*. Retrieved October 22, 2008, from http://www.pilotfriend.com/safe/safety/icing_conditions.htm

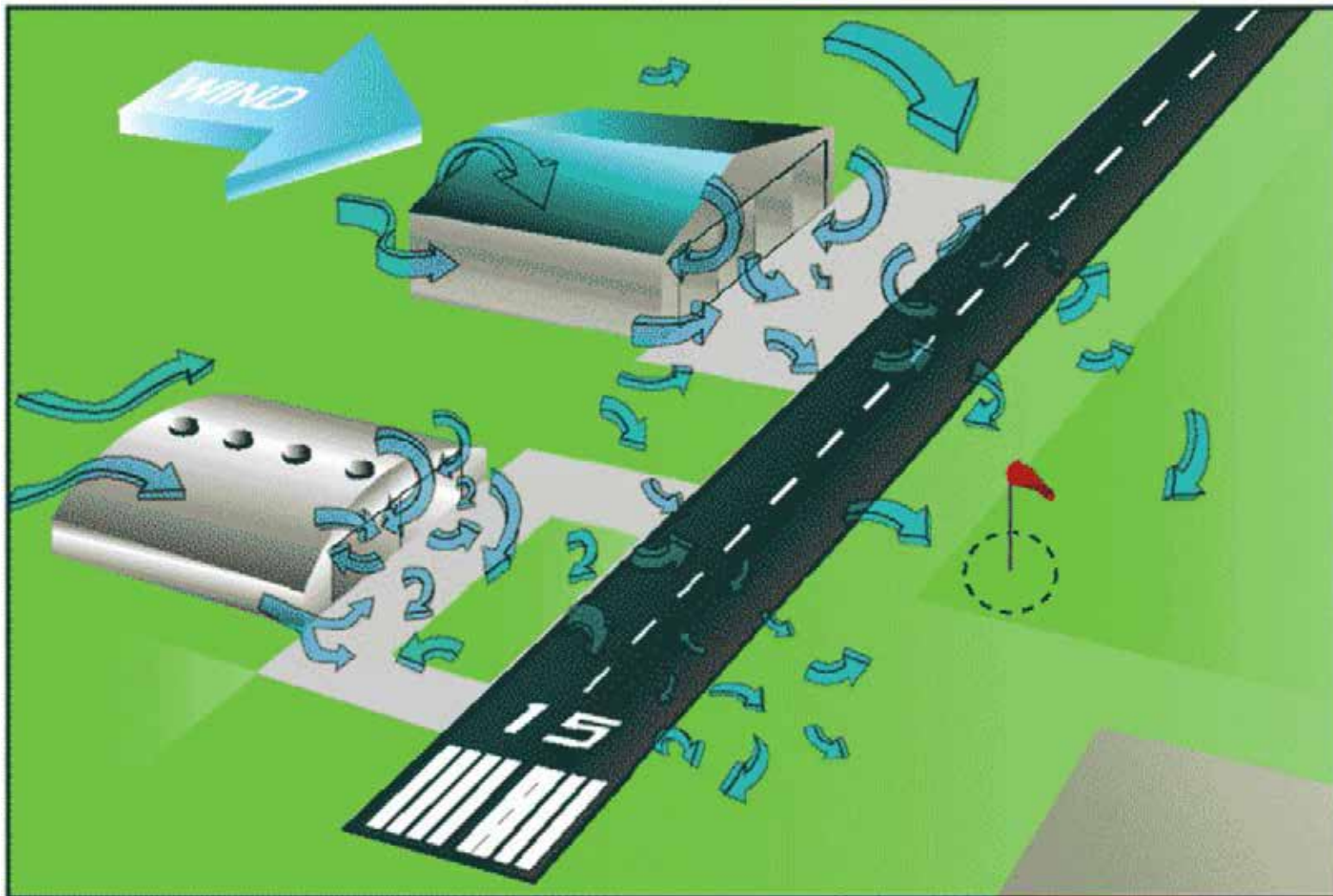

Figure A-6 Mechanical Turbulence

Note. From "Aviation Weather", *Free Online Private Pilot Ground School*. Retrieved October 22, 2008, from <http://www.free-online-private-pilot-ground-school.com/Aviation-Weather-Principles.html>

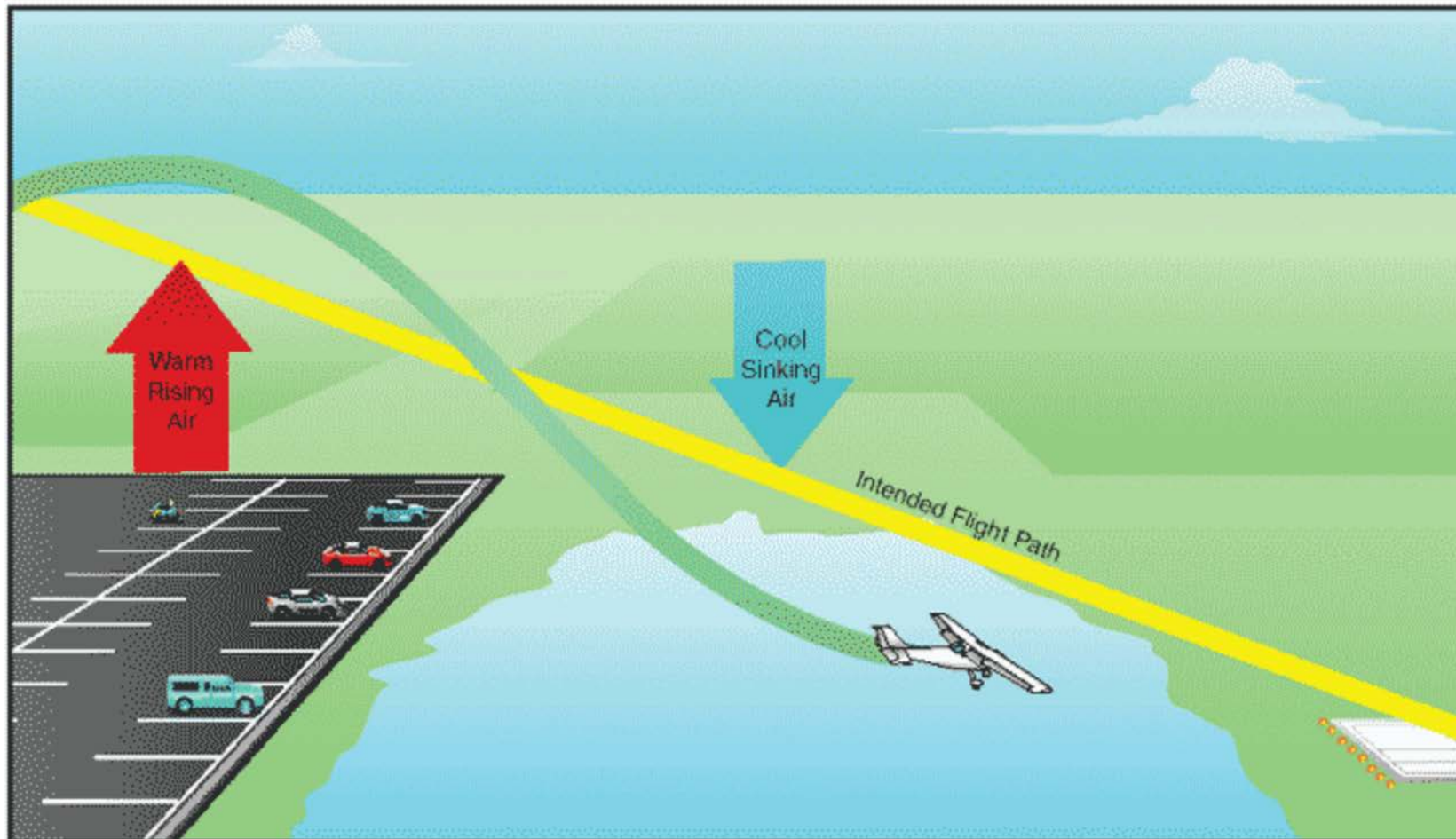

Figure A-7 Thermal Turbulence

Note. From "Aviation Weather", *Free Online Private Pilot Ground School*. Retrieved October 22, 2008, from <http://www.free-online-private-pilot-ground-school.com/Aviation-Weather-Principles.html>

THIS PAGE INTENTIONALLY LEFT BLANK



**ROYAL CANADIAN AIR CADETS
PROFICIENCY LEVEL FOUR
INSTRUCTIONAL GUIDE**



SECTION 5

EO C436.03 – ANALYZE WEATHER INFORMATION

Total Time: 90 min

PREPARATION

PRE-LESSON INSTRUCTIONS

Resources needed for the delivery of this lesson are listed in the lesson specification located in A-CR-CCP-804/PG-001, *Proficiency Level Four Qualification Standard and Plan*, Chapter 4. Specific uses for said resources are identified throughout the instructional guide within the TP for which they are required.

Review the lesson content and become familiar with the material prior to delivering the lesson.

Prepare the slides located at Attachments A, C–G, I and J.

Photocopy the handouts located at Attachments B and H.

Make handouts of recent METARs, TAFs, FDs and GFAs in standard format from the NAV CANADA aviation weather website for each cadet.

Make a copy in plain language of the same METARs, TAFs, FDs and GFAs handouts from the NAV CANADA aviation weather website being given to each cadet.

PRE-LESSON ASSIGNMENT

Nil.

APPROACH

An interactive lecture was chosen for TPs 1–7 to introduce weather reports and forecasts, to give the cadets the basic material they need to decode and analyze the information and to generate interest in the subject.

An in-class activity was chosen for TP 8 as it is an interactive way for the cadets to practice analyzing weather information under supervision.

INTRODUCTION

REVIEW

Nil.

OBJECTIVES

By the end of this lesson the cadet shall have analyzed weather information.

IMPORTANCE

It is important for cadets to analyze weather information as this skill is used by cadets to analyze weather when preparing for day-to-day activities and to fly. Being able to analyze weather information provides knowledge for potential instructional duties and is part of the fundamentals that cadets pursuing future aviation training will require.

Teaching Point 1**Describe a METAR.**

Time: 5 min

Method: Interactive Lecture

METARs



Show the cadets the slide of Attachment A.

Definition

METAR is the name given to the international meteorological code used in aviation routine weather reports. These reports describe the existing weather conditions at a specific time and location. In other words, the METAR is a snapshot of the current weather; it is not a forecast.

Frequency of Reports

METARS are normally issued every hour, on the hour as weather does not normally change much in this brief period of time. METARs are only valid at the time that they are issued, not for the hour between reports.

Special Weather Reports (SPECI)

There are times when the weather changes drastically in a short period of time. When this happens a SPECI is issued. SPECIs use the same code as a METAR, but start with SPECI.

Where METARs are Available

METARs can be found at several locations. The three most common locations are:

- NAV CANADA's aviation weather website,
- a Flight Services Station (FSS), and
- a Flight Information Centre (FIC) (normally accessed by phone).

CONFIRMATION OF TEACHING POINT 1**QUESTIONS:**

- Q1. What does a METAR describe?
- Q2. How often are METARs normally issued?
- Q3. When is a SPECI issued?

ANTICIPATED ANSWERS:

- A1. A METAR describes the existing weather conditions at a specific time and location.
- A2. METARS are normally issued every hour, on the hour.
- A3. A SPECI is used when the weather changes drastically in a short period of time.

Teaching Point 2**Familiarize the cadets with METAR terminology.**

Time: 15 min

Method: Interactive Lecture

TERMINOLOGY USED IN METARs

Indicate on the slide of Attachment A each of the following groupings as they are covered.

METAR is a code used in aviation weather reporting. This code is based on the World Meteorological Organization's (WMO) standards and conventions. A METAR is organized into sections with each section always in the same order.

Report Type

The report name is in the first line of the text. The name will show as either METAR or SPECI.

Location Indicator

Each weather reporting station in Canada is assigned a four-letter identifier, starting with the letter C. The second letter indicates the type of station and the last two letters identify the specific reporting station.

For example, CYOW is the reporting station at Ottawa / MacDonald-Cartier International Airport. The C means the station is Canadian, the Y means the station is co-located with an airport, and OW is the airport identifier.

Date and Time of Observation

The date and time of the observation are given as a six-digit grouping, based on Coordinated Universal Time (UTC / ZULU / Z). The first two digits signify the day of the current month, while the last four digits signify the time of the day. The official time of the observation is given for all METAR reports that do not deviate more than 10 minutes from the top of the hour. SPECIs will have the time reported to the exact minute.

For example, a METAR will show as 091000Z which means that the observation was taken on the ninth day of the month at 1000 hours UTC (or within 10 minutes of that hour).

For example, a SPECI will show as 091036Z, which means that a significant change in weather was observed on the ninth day of the month at 1036 hours UTC.

Report Modifier

This field may contain two possible codes: AUTO or CC* (where * is a letter from A–Z which represents corrections). AUTO indicates that the report is primarily based on observations from an automated weather observation station (AWOS). CC* is used to indicate corrected reports, where the first correction is CCA, the second is CCB, and so on. Both AUTO and CC* may be found in the same report.

Wind

This group reports the two-minute average wind direction and speed. Direction is always three digits, given in degrees true but rounded off to the nearest 10 degrees. Speed is normally two digits, and is given in knots (nautical miles per hour or kt). A reading of 0000KT indicates calm winds.

For example, 35016KT means winds are from 350 degrees true (rounded off) at 16 knots.

If gust conditions exist, the direction and speed will be followed by a G and the maximum gust strength. A gust must be five knots stronger than the 10-minute average wind speed.

For example, 35016G25KT means winds are from 350 degrees true at 16 knots gusting to 25 knots.

Prevailing Visibility

Prevailing visibility is the average visibility at the reporting station. The prevailing visibility is reported in statute miles (SM) or fractions of a statute mile.

For example, 3SM means the prevailing visibility is 3 statute miles.

Runway Visual Range

This is only included if the prevailing visibility is less than 1 SM, or the runway visual range is less than 6 000 feet. This group will start with an R, then the runway number (eg, 06) and position (eg, L for left, R for right, C for centre), followed by the runway visual range in hundreds of feet. This is based on a 10-minute average. The runway visual range trend is indicated if there is a distinct upward or downward trend from the first to the second five-minute part-period. If the runway visual range changes by 300 feet or more it is indicated as /U for an upward trend or /D for a downward trend. No distinct change is indicated as /N. If it is not possible to determine the trend it will be left blank.

For example, R06L/4000FT/D means the runway visual range for runway 06 left is 4 000 feet with a downward trend.

Present Weather



Distribute the handout of Attachment B to the cadets.

This group indicates the current weather phenomena at the reporting station. This may include precipitation, obscuration, or other phenomena.

Each phenomenon is represented by a code, which may be two to nine characters in length. Each code may include one or both of the following prefixes:

- **Intensity.** (-) indicates light, (+) indicates heavy, and no symbol indicates moderate.
- **Proximity.** Used primarily with precipitation or tornadoes. VC will precede certain phenomena, meaning that they are in the vicinity (5 SM) of the station, but not actually at the station.

For example, VCFZRABLSN+SNVA means in the vicinity of the airport there is freezing rain, blowing snow, heavy snow, and volcanic ash.



The abbreviations used for present weather are a mixture of English and French root words. FZ comes from freezing, while BR comes from brumé (mist), and FU comes from fumée (smoke).

Sky Conditions

This group reports the sky condition for layers aloft. The group will include how much of the sky is covered, measured in oktas (eighths of the sky) and the height of the clouds in hundreds of feet above ground level (AGL). The sky cover is represented by the following abbreviations:

- **SKC.** Sky clear, no cloud present.
- **FEW.** Few, greater than zero to two-eighths cloud cover.
- **SCT.** Scattered, three-eighths to four-eighths cloud cover.
- **BKN.** Broken, five-eighths to less than eight-eighths cloud cover.
- **OVC.** Overcast, eight-eighths cloud cover.
- **CLR.** Clear, clear below 10 000 feet AGL.

Cloud height is represented by a three-digit number, which when multiplied by one hundred equals the actual height AGL. There will be one entry for every layer of cloud.

For example, SCT025 means scattered cloud at 2 500 feet AGL.

Temperature and Dewpoint

This group reports the air temperature and dewpoint temperature, rounded to the nearest whole degree Celsius. A negative value will be preceded by an M. A forward slash (/) will separate the two values.

For example, M05/M08 means the temperature is minus five degrees Celsius and the dewpoint is minus eight degrees Celsius.

Altimeter Setting

This group reports the altimeter setting at the reporting station in inches of mercury. The group starts with an A followed by four digits, which directly relate to the actual value of the altimeter setting. Place a decimal after the second digit in order to read this group.

For example, A3006 means the altimeter setting is 30.06 inches of mercury.

Recent Weather

This group reports recent weather of operational significance. The group indicator RE follows without a space, by the appropriate abbreviation(s) for weather observed during the period since the last METAR or SPECI, but not observed at the time of observation.

For example, RE+PL means although not observed now, there were heavy ice pellets recently reported.

Wind Shear

This group reports low level wind shear (within 1 600 feet AGL) along the takeoff or approach path of the designated runway. The two-number runway identifier is used, to which the letters L, C, or R may be appended. If the existence of wind shear applies to all runways, WS ALL RWY is used.

Remarks

This group will usually include cloud types in each layer as well as opacity, general weather remarks, and sea level pressure measured in hectopascals (hPa). The sea level pressure will always be the last entry in a METAR, prefaced by SLP. Sea level pressure is translated by placing the decimal point between the last two digits and either adding a 9 or a 10 in front of the value given. The goal is to make the number as close to 1 000 as possible.

For example, SLP123 means sea level pressure is 1012.3 hPa.

For example, SLP998 means sea level pressure is 999.8 hPa.



SLP actually represents the station pressure or the theoretical sea level pressure at the reporting station.



The = symbol is used to indicate the end of information.

CONFIRMATION OF TEACHING POINT 2

QUESTIONS:

- Q1. How are date and time expressed in a METAR?
- Q2. What does the present weather section indicate?
- Q3. What is the last entry of a METAR?

ANTICIPATED ANSWERS:

- A1. The date and time of the observation are given in a six-digit grouping, based on universal coordinated time (UTC).
- A2. This section indicates the current weather phenomena at the reporting station.
- A3. The sea level pressure will always be the last entry in a METAR.

Teaching Point 3

Describe a TAF.

Time: 5 min

Method: Interactive Lecture

TAFs



Show the cadets the slide of Attachment C.

Definition

TAF is the name given to the international meteorological code for an aerodrome forecast. These forecasts describe the expected weather conditions that will affect takeoff and landing at the aerodrome.

Issue and Validity

TAFs are prepared for approximately 180 aerodromes across Canada. They are limited to aerodromes for which METAR and SPECI reports are available. TAFs are generally prepared four times daily with periods of coverage from 12–24 hours. A TAF is valid from the time of issue until it is amended or until the next scheduled TAF is issued.

Where TAFs are Available

TAFs can be found at several locations. The three most common locations are:

- NAV CANADA's aviation weather website,
- a Flight Services Station (FSS), and
- a Flight Information Centre (FIC) (normally accessed by phone).

CONFIRMATION OF TEACHING POINT 3

QUESTIONS:

- Q1. What do TAFs describe?
- Q2. How often are TAFs generally prepared?
- Q3. Where can TAFs be found?

ANTICIPATED ANSWERS:

- A1. The expected weather conditions that will affect takeoff and landing at an aerodrome.
- A2. Four times daily.
- A3. TAFs can be found at:
- NAV CANADA's aviation weather website,
 - an FSS, or
 - an FIC.

Teaching Point 4

Familiarize the cadets with TAF terminology.

Time: 15 min

Method: Interactive Lecture

TERMINOLOGY USED IN TAFs



Indicate on the slide of Attachment C each of the following groupings as they are covered.



Much of this information will be a brief review as TAFs are similar to METARs in many ways. The abbreviations of expected weather conditions will follow the same form and order of the METAR, and will have the same meaning.

A TAF is organized into sections with each section always in the same order.

Report Type

The code name TAF is given in the first line of text. It may be followed by “AMD” for amended or corrected forecasts.

Location Indicator

A four-letter International Civil Aviation Organization (ICAO) location indicator is used, as in the METAR.

Date and Time of Origin

As with the METAR format, the day of the month and time (UTC) of origin are included in all forecasts. TAFs are issued approximately 30 minutes before the validity period. Some forecasts have update cycles as frequent as every three hours; however, the next issue time will always be indicated in the remarks group.

Period of Validity

The period of validity for the TAF is indicated by two four-digit date / time groups. The first four-digit group indicates the start date and time of the TAF, and the second four-digit group indicates the end date and time of the TAF. The maximum validity period for a TAF is 30 hours; however, some TAFs have staggered issue times and more frequent update cycles, which will affect their periods of validity.

Wind

The forecasted wind direction and speed are encoded as in a METAR.

Low-Level Wind Shear

This group is used if the forecaster has strong evidence to expect significant, non-convective wind shear that could adversely affect aircraft operation within 1 500 feet AGL over the aerodrome. The coded grouping begins with the letters WS followed by a three-digit grouping indicating the height in hundreds of feet AGL of the shear zone. A slash followed by a five-digit group indicates the wind speed and direction at that height.

For example, WS 015/20015KT means wind shear is forecast at 1 500 feet AGL over the aerodrome. The wind will be from 200 degrees true at 15 knots.

Prevailing Visibility

The prevailing visibility is encoded as in a METAR, except that visibility greater than six statute miles will be indicated by the code P6SM.

For example, 3/4SM means the visibility is forecast to be 3/4 statute mile.

Significant Weather



Refer the cadets to the handout of Attachment B.

Significant weather is encoded with the same codes as present weather in METARs. Intensity and proximity qualifiers, descriptors, precipitation, and obscuration are included as required.

For example, -RA BR means light rain and mist.

Sky Condition

Sky condition is encoded as in a METAR. Possible codes for sky cover amounts are SKC, FEW, SCT, BKN, OVC, CLR, and VV. A vertical visibility (VV) is reported in hundreds of feet when the sky is obscured. Forecast cloud type is not identified except in the case of cumulonimbus layers.

For example, BKN040CB means broken cumulonimbus cloud at 4 000 feet.

Change Groups

There are four change groups:

- FM (from),
- BECMG (becoming),
- TEMPO (temporarily), and
- PROB (probability).

FM. Indicates the weather is forecast to change permanently and rapidly. All forecast conditions given before this group are superseded by the conditions indicated after the group. In other words, a complete forecast will follow and all elements must be indicated, including those for which no change is forecast. The time group represents hours and minutes in UTC.

For example, FM280945 means from the 28th day of the month at 0945Z.

BECMG. Used when a permanent change in a few weather elements is forecast to occur gradually, with conditions evolving over a period of time (normally one to two hours, but not more than four hours). Normally only those elements for which a change is forecast to occur will follow BECMG. Any forecast weather element not indicated as part of the BECMG group remains the same as the period prior to the change.

The start and stop time of the change period is indicated by two four-digit date / time groups following BECMG. The first two digits of each group indicate the date, while the last two digits of each group indicate the time in whole UTC hours.

For example, BECMG 2808/2809 OVC030 means a change towards overcast sky conditions at 3 000 ft AGL occurring gradually between 0800Z and 0900Z on the 28th day of the month.

TEMPO. Used when a temporary fluctuation in some or all of the weather elements is forecast to occur during a specified period. When an element is not indicated after TEMPO, it is the same as the period prior to the change. The time period is indicated the same as with BECMG.

For example, TEMPO 2812/2815 1SM RA BR means temporarily between 1200Z and 1500Z on the 28th day of the month, visibility is forecast to be one statute mile with rain and mist.



If a significant change in weather or visibility is forecast, all weather groups are indicated following BECMG or TEMPO, including those that are unchanged. When the ending of significant weather is forecast, the abbreviation NSW (no significant weather) is used.

PROB. Used to indicate a 30 or 40 percent probability of changing conditions that would constitute a hazard to aviation, such as thunderstorms, freezing precipitation, and low-level wind shear. The time period is indicated the same as with BECMG and TEMPO.

For example, PROB30 2817/2821 1/2SM +TSRAGR means there is a 30 percent probability between 1700Z and 2100Z on the 28th day of the month that visibility will be 1/2 statute mile with heavy thunderstorms, rain, and hail.



A probability of less than 30 percent is not considered to justify the use of the PROB group. When the probability is 50 percent or more, this shall be indicated by the use of BECMG, TEMPO, or FM, as appropriate.

Remarks

Remarks will be prefaced by the abbreviation RMK. Remarks may include such information as when a TAF is based on observations taken by an Automated Weather Observation System (AWOS), and when there are significant discrepancies between the AWOS and a TAF. Remarks will indicate the issue date and time (UTC) of the next regular TAF.

CONFIRMATION OF TEACHING POINT 4

QUESTIONS:

- Q1. What abbreviation will be used when the ending of significant weather is forecast?
- Q2. What does the change group FM indicate?
- Q3. In which section will the issue time for the next TAF be indicated?

ANTICIPATED ANSWERS:

- A1. NSW.
- A2. FM indicates the weather is forecast to change permanently and rapidly.
- A3. The remarks section.

Teaching Point 5

Describe an FD.

Time: 5 min

Method: Interactive Lecture

FDs



Show the cadets the slide of Attachment D.

Definition

An FD is an forecast of upper wind conditions and temperatures at selected levels. Wind direction is given in degrees true to the nearest ten degrees and wind speed is in knots.

Decoding



Temperatures are not forecast for 3 000 feet; in addition, this level is omitted if the terrain elevation is greater than 1 500 feet. All forecast temperatures for altitudes over 24 000 feet are negative.

When the forecast speed is less than five knots, the code group is 9900, which reads light and variable. Encoded wind speeds from 100–199 knots have 50 added to the direction code and 100 subtracted from the speed. Wind speeds that have had 50 added to the direction can be recognized when figures from 51–86 appear in the code. Since no such directions exist (eg, 510 degrees to 860 degrees), obviously they represent directions from 010 degrees to 360 degrees. Should the forecast wind speed be 200 knots or greater, the wind group is coded as 199 knots. For example, 7799 is decoded as 270 degrees at 199 knots or greater.



Show the cadets the slide of Attachment E.

Examples of decoding FD winds and temperatures are as follows (the third and fourth examples are for altitudes above 24 000 feet):

EXAMPLE	DECODED
9900+00	Wind light and variable. Temperature zero degrees Celsius.
2523	Wind 250 degrees true at 23 knots.
791159	Wind 290 degrees true ($79 - 50 = 29$) at 111 knots ($11 + 100 = 111$). Temperature minus 59 degrees Celsius.
859950	Wind 350 degrees true ($85 - 50 = 35$) at 199 knots or greater, temperature minus 50 degrees Celsius.

Figure 1 FD Decoding

Note. From *Aeronautical Information Manual*. by Transport Canada, 2008, Retrieved October 27, 2008, from <http://www.tc.gc.ca/publications/EN/TP14371/PDF/HR/TP14371E.PDF>

Where FDs are Available

FDs can be found at several locations. The three most common locations are:

- NAV CANADA's aviation weather website,
- a Flight Services Station (FSS), and
- a Flight Information Centre (FIC) (normally accessed by phone).

CONFIRMATION OF TEACHING POINT 5

QUESTIONS:

- Q1. What is an FD?
 Q2. At which level are temperatures not forecast?
 Q3. What does the code group 9900 mean?

ANTICIPATED ANSWERS:

- A1. An FD is a forecast of upper wind conditions and temperatures at selected levels.
 A2. 3 000 feet.
 A3. Winds are light and variable.

Teaching Point 6

Describe a GFA.

Time: 10 min

Method: Interactive Lecture

GFA's



Show the cadets the slide of Attachment F.

Definition

A GFA consists of a series of weather charts, each depicting the most probable meteorological conditions expected to occur below 24 000 feet, over a given area at a specified time.

Issue and Validity

GFA charts are issued four times daily, approximately 30 minutes before the beginning of the forecast period. GFAs are issued at approximately 2330, 0530, 1130, and 1730 UTC and are valid at 0000, 0600, 1200, and 1800 UTC respectively.



Each issue of the GFA is a collection of six charts; two charts valid at the beginning of the forecast period, two charts valid six hours into the forecast period and the final two charts valid twelve hours into the forecast period. Of the two charts valid at each of the three forecast periods, one chart depicts clouds and weather while the other chart depicts icing, turbulence, and freezing level. The cadets will learn to read only the GFA Clouds and Weather Chart.

Coverage Area



Show the cadets the slide of Attachment G.

There are seven distinct GFA areas covering the entire Canadian Domestic Airspace.

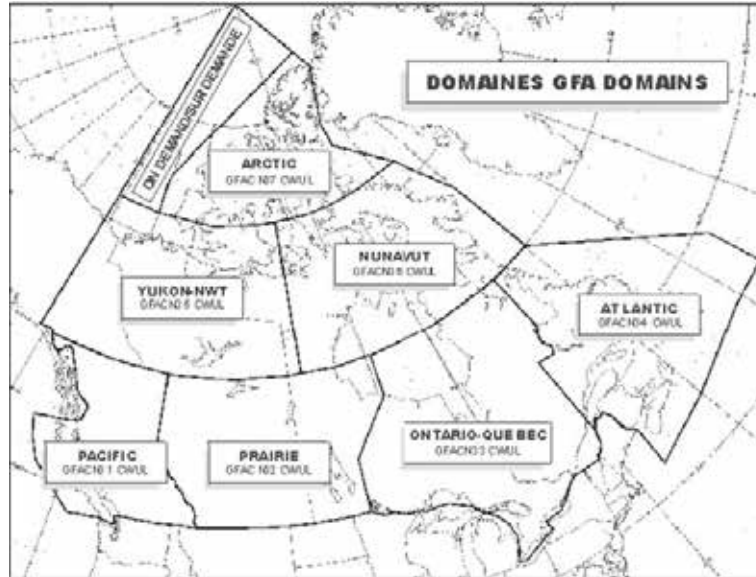

Figure 2 GFA Domains

Note. From *Aeronautical Information Manual*, by Transport Canada, 2008, Retrieved October 27, 2008, from <http://www.tc.gc.ca/publications/EN/TP14371/PDF/HR/TP14371E.PDF>

Units of Measure

Speeds in a GFA are expressed in knots (kt). Horizontal visibility is measured in statute miles (SM). Times are stated in Co-ordinated Universal Time (UTC). A nautical-mile (NM) scale bar is included to assist in determining approximate distances on the chart. All heights are measured in hundreds of feet above sea level (ASL) unless otherwise noted.

Abbreviations and Symbols

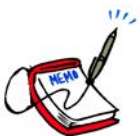

Distribute the handout of Attachment H to the cadets. Show the cadets the slide of Attachment I.

Only standard meteorological abbreviations are used in a GFA. Figure 3 is a list of common weather symbols that may be found in a GFA.



	TS	Thunderstorm
	PL	Ice Pellets
	FZRA	Freezing Rain
	FZDZ	Freezing Drizzle

Figure 3 Weather Symbols

Note. Created by Director Cadets 3, 2008, Ottawa, ON: Department of National Defence.

Where GFAs are Available

GFAs can be found at several locations. The three most common locations are:

- NAV CANADA's aviation weather website,
- a Flight Services Station (FSS), and
- a Flight Information Centre (FIC) (normally accessed by phone).

CONFIRMATION OF TEACHING POINT 6

QUESTIONS:

- Q1. How often are GFAs issued?
- Q2. How are heights measured in GFAs unless otherwise noted?
- Q3. How many distinct GFA coverage areas are there in Canada?

ANTICIPATED ANSWERS:

- A1. Four times daily.
- A2. In hundreds of feet above sea level (ASL).
- A3. Seven.

Teaching Point 7

Familiarize the cadets with GFA Clouds and Weather Chart layout.

Time: 15 min

Method: Interactive Lecture

GFA CLOUDS AND WEATHER CHART LAYOUT



Indicate on the slide of Attachment F each of the following groupings as they are covered.

Each GFA chart is divided into four parts: title box, legend box, comments box, and weather information section.

Weather Information Section	Title Box
	Legend Box
	Comments Box

Figure 4 GFA Chart Layout

Note. Created by Director Cadets 3, 2008, Ottawa, ON: Department of National Defence.

Title Box

The title box includes the chart name, issuing office four-letter identification, name of the GFA region, chart type, the date and time of issue, and the validity period.

Legend Box

The legend box includes weather symbols that may be used in the weather information part of the GFA chart. It also includes a nautical-mile scale bar to facilitate determining distances.

Comments Box

The comments box provides information that the weather forecaster considers important (eg, formation or dissipation of fog, increasing or decreasing visibility). It is also used to describe elements that are difficult to render pictorially or, if added to the depiction, would cause the chart to become cluttered (eg, light icing). The following standard phrases are also included in the comments box:

- HGTS ASL UNLESS NOTED,
- CB TCU AND ACC IMPLY SIG TURB AND ICG, and
- CB IMPLIES LLWS.

The comments box of the 12-hour GFA Clouds and Weather Chart also includes an Instrument Flight Rules (IFR) outlook for an additional 12-hour period in the lower section of the box. The IFR outlook is always general in nature, indicating the main areas where IFR weather is expected, the cause for the IFR weather, and any associated weather hazards.

Weather Information Section

The weather information section of the chart depicts a forecast of the clouds and weather conditions.

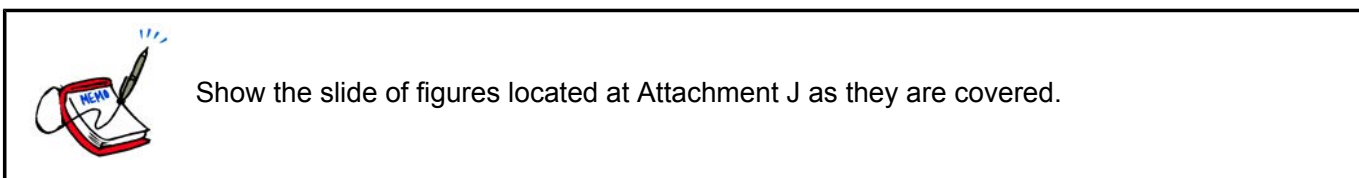

Synoptic features. The motion of synoptic features, when the speed of movement is forecast to be five knots or more, will be indicated by an arrow and a speed value. For speeds less than five knots, the letters QS (quasi-stationary) are used.

For example, a low pressure centre moving eastwards at 15 knots with an associated cold front moving southeast at 10 knots would be indicated as follows:

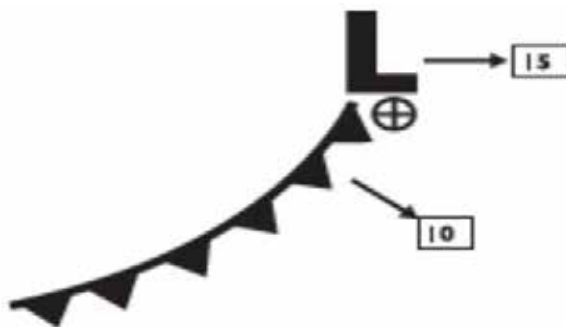

Figure 5 Synoptic Features

Note. From *Aeronautical Information Manual*. by Transport Canada, 2008, Retrieved October 27, 2008, from <http://www.tc.gc.ca/publications/EN/TP14371/PDF/HR/TP14371E.PDF>

Clouds. The bases and tops of forecast clouds between the surface and 24 000 feet ASL will be indicated. The tops of convective clouds (eg, TCU, ACC, CB) are indicated, even if they extend above 24 000 feet ASL. Cirrus clouds are not depicted on the chart. The cloud type will be indicated if considered significant, however, convective clouds such as CU, TCU, ACC, and CB will always be stated when forecast to be present.

A scalloped border encloses organized areas of clouds where the sky condition is either broken (BKN) or overcast (OVC).

For example, an organized area of broken cumulus clouds based at 2 000 feet ASL with tops at 8 000 feet ASL would be indicated as follows:

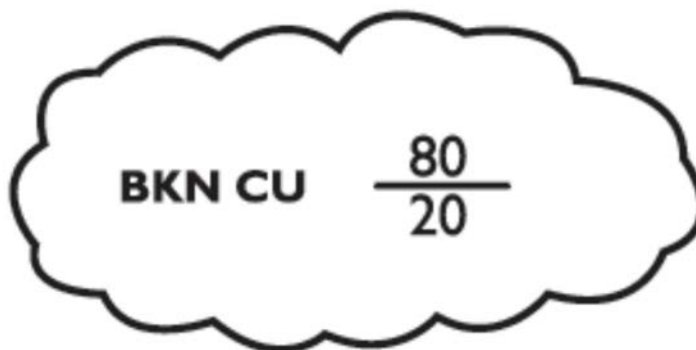

Figure 6 Broken Cumulus Clouds

Note. From *Aeronautical Information Manual*. by Transport Canada, 2008, Retrieved October 28, 2008, from <http://www.tc.gc.ca/publications/EN/TP14371/PDF/HR/TP14371E.PDF>

In areas where organized clouds are not forecast and the visibility is expected to be greater than six statute miles a scalloped border is not used.

For example, unorganized scattered clouds based at 3 000 feet ASL with tops at 5 000 feet ASL would be indicated as follows:

SCT $\frac{50}{30}$

Figure 7 Scattered Clouds

Note. From *Aeronautical Information Manual*. by Transport Canada, 2008, Retrieved October 28, 2008, from <http://www.tc.gc.ca/publications/EN/TP14371/PDF/HR/TP14371E.PDF>

When multiple cloud layers are forecast, the bases and tops of each layer are indicated.

For example, a scattered layer of cumulus cloud based at 3 000 feet ASL with tops at 5 000 feet ASL and a higher overcast layer of altostratus cloud based at 10 000 feet ASL with tops at 13 000 feet ASL would be indicated as follows:

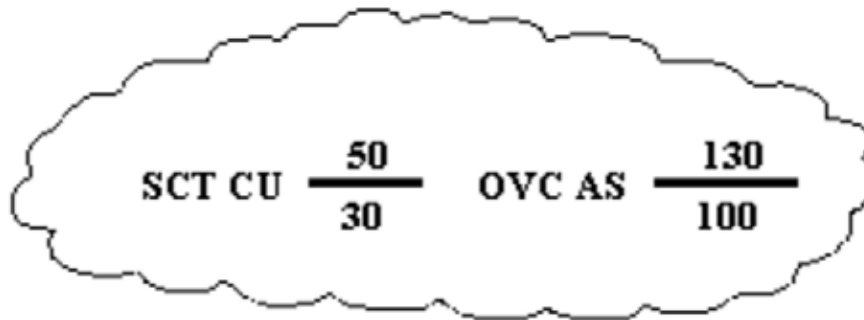

Figure 8 Multiple Cloud Layers

Note. From *Aeronautical Information Manual*. by Transport Canada, 2008, Retrieved October 28, 2008, from <http://www.tc.gc.ca/publications/EN/TP14371/PDF/HR/TP14371E.PDF>

Surface-based layers. The abbreviation OBSCD (obscured) is used to describe surface-based layers. The vertical visibility in surface-based layers is measured in hundreds of feet AGL.

For example, local obscured ceilings with a vertical visibility between 300 and 500 feet AGL would be indicated as: LCL OBSCD CIG 3 - 5 AGL.

Visibility. The forecast visibility is measured in statute miles. When the visibility is expected to be greater than six statute miles, it is indicated as P6SM.

For example, a forecast visibility that is expected to vary between two and four statute miles with light rain showers would be indicated as: 2 - 4 SM - SHRA.

Weather and obstructions to vision. Forecast weather is always included immediately after the visibility. Obstructions to vision are only mentioned when the visibility is forecast to be six statute miles or less (eg, 2 - 4SM - RA BR). Areas of showery or intermittent precipitation are shown as hatched areas enclosed by a dashed green line. Areas of continuous precipitation are shown as stippled areas enclosed by a solid green line. Areas of obstruction to vision not associated with precipitation, where visibility is six statute miles or less, are enclosed by a dashed orange line. Areas of freezing precipitation are depicted in red and enclosed by a solid red line.

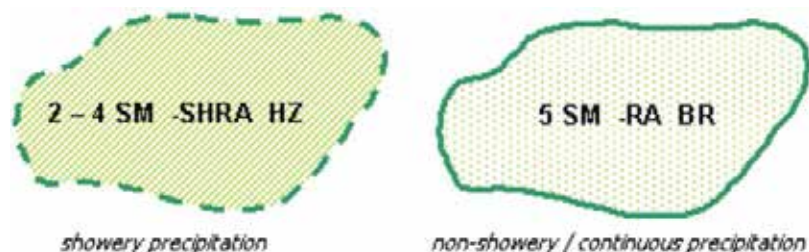

Figure 9 Weather and Obstructions to Vision

Note. From Nav Canada, 2007, *Aviation Weather Website*. Retrieved October 28, 2008, from http://www.flightplanning.navcanada.ca/cgi-bin/CreePage.pl?Page=info-gfa&NoSession=NS_Inconnu&TypeDoc=gfa&Langue=anglais#abbr_symb

Isobars. Lines joining points of equal surface pressure. They are included in the GFA Clouds and Weather Chart at four-millibar intervals.

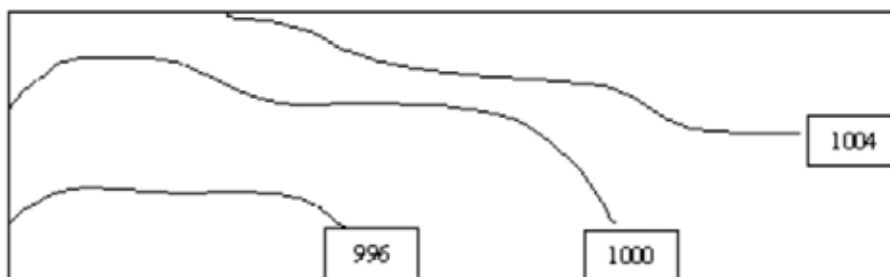

Figure 10 Isobars

Note. From Nav Canada, 2007, *Aviation Weather Website*. Retrieved October 28, 2008, from http://www.flightplanning.navcanada.ca/cgi-bin/CreePage.pl?Page=info-gfa&NoSession=NS_Inconnu&TypeDoc=gfa&Langue=anglais#abbr_symb

Surface winds. The speed and direction of forecast surface winds with a sustained speed of at least 20 knots are indicated by wind barbs and an associated wind speed value. Wind gusts are indicated by the letter G, followed by the peak gust speed in knots.

For example, surface winds forecast to be from the west (270 degrees true) with a speed of 25 knots and a peak gust speed of 35 knots would be indicated as:



Figure 11 Surface Winds

Note. From *Aeronautical Information Manual*. by Transport Canada, 2008, Retrieved October 28, 2008, from <http://www.tc.gc.ca/publications/EN/TP14371/PDF/HR/TP14371E.PDF>

CONFIRMATION OF TEACHING POINT 7

QUESTIONS:

- Q1. In which section of a GFA Clouds and Weather Chart would an IFR outlook be found?
- Q2. How are areas of showery or intermittent precipitation shown?
- Q3. How are organized areas of clouds where the sky condition is either broken or overcast shown?

ANTICIPATED ANSWERS:

- A1. Comments box.
- A2. As hatched areas enclosed by a dashed green line.
- A3. Enclosed by a scalloped border.

Teaching Point 8

Conduct an activity to have the cadets read METARs, TAFs, FDs and GFA Clouds and Weather Charts.

Time: 15 min

Method: In-Class Activity

ACTIVITY

OBJECTIVE

The objective of this activity is to have the cadets read METARs, TAFs, FDs and GFA Clouds and Weather Charts.

RESOURCES

- Handouts of two or three copies of METARs, TAFs, FDs and GFA Clouds and Weather Charts in standard format,
- Copies of the same METARs, TAFs, FDs and GFA Clouds and Weather Charts in plain language format for review, and
- Abbreviations handout located at Attachment H.

ACTIVITY LAYOUT

Nil.

ACTIVITY INSTRUCTIONS

1. Divide the cadets into pairs.
2. Distribute the handouts of METARs, TAFs, FDs and GFA Clouds and Weather Charts in standard format among the pairs.
3. Show the cadets a sample METAR, TAF, FD and GFA Clouds and Weather Chart and demonstrate reading it.
4. Indicate a section of a METAR, TAF, FD and GFA Cloud and Weather Chart and have the cadets read it.

5. Display the copies of the same METARs, TAFs, FDs and GFA Clouds and Weather Charts in plain language format to correct the cadets' work.
6. Repeat Steps 3–5 as time permits.

SAFETY

Nil.

CONFIRMATION OF TEACHING POINT 8

The cadets' participation in the activity will serve as the confirmation of this TP.

END OF LESSON CONFIRMATION

The cadets' participation in the activity will serve as the confirmation of this lesson.

CONCLUSION

HOMEWORK / READING / PRACTICE

Nil.

METHOD OF EVALUATION

Nil.

CLOSING STATEMENT

Weather is a major factor in aviation. Pilots must constantly watch the weather around them as it will affect the operation and navigation of an aircraft. In particular, pilots must analyze weather information prior to flying to decide whether it is safe to fly.

INSTRUCTOR NOTES / REMARKS

Recent METARs, TAFs, FDs, and GFAs can be found at <http://www.flightplanning.navcanada.ca>. Click on the METAR / TAF, UPR WND (FDs), or Graphical FA icon and choose the desired region. METARs, TAFs, FDs, and GFAs can be printed in standard and plain language format.

It is recommended that the three periods required for this EO be scheduled consecutively.

Cadets who are qualified Advanced Aviation may assist with this instruction.

REFERENCES

C2-044 *Aeronautical Information Manual*. by Transport Canada, 2008, Retrieved September 29, 2008, from <http://www.tc.gc.ca/publications/EN/TP14371/PDF/HR/TP14371E.PDF>

C3-116 ISBN 0-9680390-5-7 MacDonald, A. F., & Peppler, I. L. (2000). *From the ground up: Millennium edition*. Ottawa, ON: Aviation Publishers Co. Limited.

THIS PAGE INTENTIONALLY LEFT BLANK

SAMPLE METARs AND SPECIs

METAR CYHZ 111700Z 28009G16KT 15SM FEW250 00/
M11 A2990 RMK CS0 SLP134=

METAR CYHZ 111800Z 29015KT 15SM FEW250 01/M10
A2989 RMK CI0 SLP128=

METAR CYHZ 111900Z 30008KT 15SM FEW250 02/M12
A2987 RMK CI0 SLP123=

SPECI CYYJ 111744Z CCA 23019G24KT 20SM -SHRA
BKN014 BKN030 BKN120 09/07 RMK SC5SC1AC1=

SPECI CYYJ 111744Z 23019G24KT 20SM -RA BKN014
BKN030 BKN120 09/07 RMK SC5SC1AC1=

THIS PAGE INTENTIONALLY LEFT BLANK

WORLD METEOROLOGICAL ORGANIZATION CODE FOR PRESENT WEATHER

QUALIFIER				WEATHER PHENOMENA				
INTENSITY or PROXIMITY 1	DESCRIPTOR 2		PRECIPITATION 3		OBSCURATION 4		OTHER 5	
Note: Precipitation intensity refers to all forms combined.	MI	Shallow	DZ	Drizzle	BR	Mist (Vis ≥ 5/8 SM)	PO	Dust/ Sand Whirls (Dust Devils)
	BC	Patches	RA	Rain	FG	Fog (Vis < 5/8 SM)	SQ	Squalls
	PR	Partial	SN	Snow	FU	Smoke (Vis ≤ 6 SM)	+FC	Tornado or Waterspout
	DR	Drifting	SG	Snow Grains				
- Light	BL	Blowing	IC	Ice Crystals (Vis 0 6 SM)	DU	Dust (Vis ≤ 6 SM)	FC	Funnel Cloud
	SH	Shower(s)						
Moderate (no qualifier)	TS	Thunderstorm	PL	Ice Pellets	SA	Sand (Vis ≤ 6 SM)	SS	Sandstorm (Vis < 5/8 SM) (+SS Vis < 516 SM)
			GR	Hail				
+ Heavy	FZ	Freezing	GS	Snow Pellets	HZ	Haze (Vis ≤ 6 SM)	DS	Dust storm (Vis < 5/8 SM) (+DS Vis < 516 SM)
VC In the vicinity			UP	Unknown precipitation (AWOS only)	VA	Volcanic Ash (with any visibility)		

Figure B-1 World Meteorological Organization Code for Present Weather

Note. From *Aeronautical Information Manual* (p. 145), by Transport Canada, 2008, Ottawa, ON: Transport Canada. Copyright 2007 by Her Majesty the Queen in Right of Canada.

THIS PAGE INTENTIONALLY LEFT BLANK

SAMPLE TAFs

TAF CYHZ 201738Z 2018/2118 25008KT P6SM OVC015
TEMPO 2018/2020 OVC025
FM202000 24010KT P6SM OVC025 TEMPO 2020/2022 OVC020
FM202200 23012KT P6SM BKN030
FM210200 23010KT P6SM SCT030
RMK NXT FCST BY 202100Z=

TAF CYVR 201739Z 2018/2124 10012G22KT P6SM -RA SCT025
OVC050 TEMPO 2021/2103 5SM -RA BR BKN020
BECMG 2021/2022 14012G22KT
BECMG 2101/2102 28020G30KT
FM210300 28020G30KT P6SM FEW030 SCT060
BECMG 2103/2104 26012KT
FM210800 11005KT P6SM -SHRA BKN030
BECMG 2110/2112 14010G20KT
FM211600 12012G22KT 5SM -RA BR SCT008 BKN012
RMK NXT FCST BY 202100Z=

TAF CYYG 201738Z 2018/2106 25012KT P6SM FEW009 OVC015
TEMPO 2018/2020 6SM -SHSN BKN009
FM202300 24012KT P6SM BKN025 TEMPO 2023/2102 BKN020
FM210200 26008KT P6SM SCT025 TEMPO 2102/2106 BKN025
RMK NXT FCST BY 210000Z=

TAF CYOW 201738Z 2018/2118 34012KT P6SM BKN040
FM202200 31005KT P6SM FEW050 SCT100
FM211600 31012KT P6SM BKN030
RMK NXT FCST BY 202100Z=

THIS PAGE INTENTIONALLY LEFT BLANK

SAMPLE FDS

STN YNA - NATASHQUAN. QUEBEC	for use	3000	6000	9000	12000	18000
FDCN01 CWAO FCST BASED ON 271200 DATA VALID 271800	17-21	2130	2129+05	2131+03	2140-03	2158-11
FDCN02 CWAO FCST BASED ON 271200 DATA VALID 280000	21-06	1916	1917+06	2023+03	2130-02	2152-11
FDCN03 CWAO FCST BASED ON 271200 DATA VALID 281200	06-17	1635	1633+05	1929+03	1936+00	1838-11

STN YQI - YARMOUTH. NS	for use	3000	6000	9000	12000	18000
FDCN01 CWAO FCST BASED ON 271200 DATA VALID 271800	17-21	1616	1919+10	1936+05	1934+00	2043-10
FDCN02 CWAO FCST BASED ON 271200 DATA VALID 280000	21-06	1842	1843+11	1843+06	1842+00	1842-10
FDCN03 CWAO FCST BASED ON 271200 DATA VALID 281200	06-17	1451	1551+10	1537+04	1651+00	1865-08

STN YQI - YARMOUTH. NS	for use	24000	30000	34000	39000	45000	53000
FDCN01 KWBC DATA BASED ON 271200Z VALID 271800Z	1700-2100Z.	2145-24	225139	225248	206558	215363	213964
FDCN02 KWBC DATA BASED ON 271200Z VALID 280000Z	2100-0600Z.	2043-23	215140	215149	214558	215062	213864
FDCN03 KWBC DATA BASED ON 271200Z VALID 281200Z	0600-1700Z.	1855-23	195738	205047	226656	216062	204264

THIS PAGE INTENTIONALLY LEFT BLANK

Decoding FDs

EXAMPLE	DECODED
9900+00	Wind light and variable, temperature zero degrees Celsius.
2523	Wind 250 degrees true at 23 knots.
791159	Wind 290 degrees true ($79 - 50 = 29$) at 111 knots ($11 + 100 = 111$), temperature -59 degrees Celsius.
859950	Wind 350 degrees true ($85 - 50 = 35$) at 199 knots or greater, temperature -50 degrees Celsius.

Figure E-1 FD Decoding

Note. From *Aeronautical Information Manual*. by Transport Canada, 2008, Retrieved October 27, 2008, from <http://www.tc.gc.ca/publications/EN/TP14371/PDF/HR/TP14371E.PDF>

THIS PAGE INTENTIONALLY LEFT BLANK

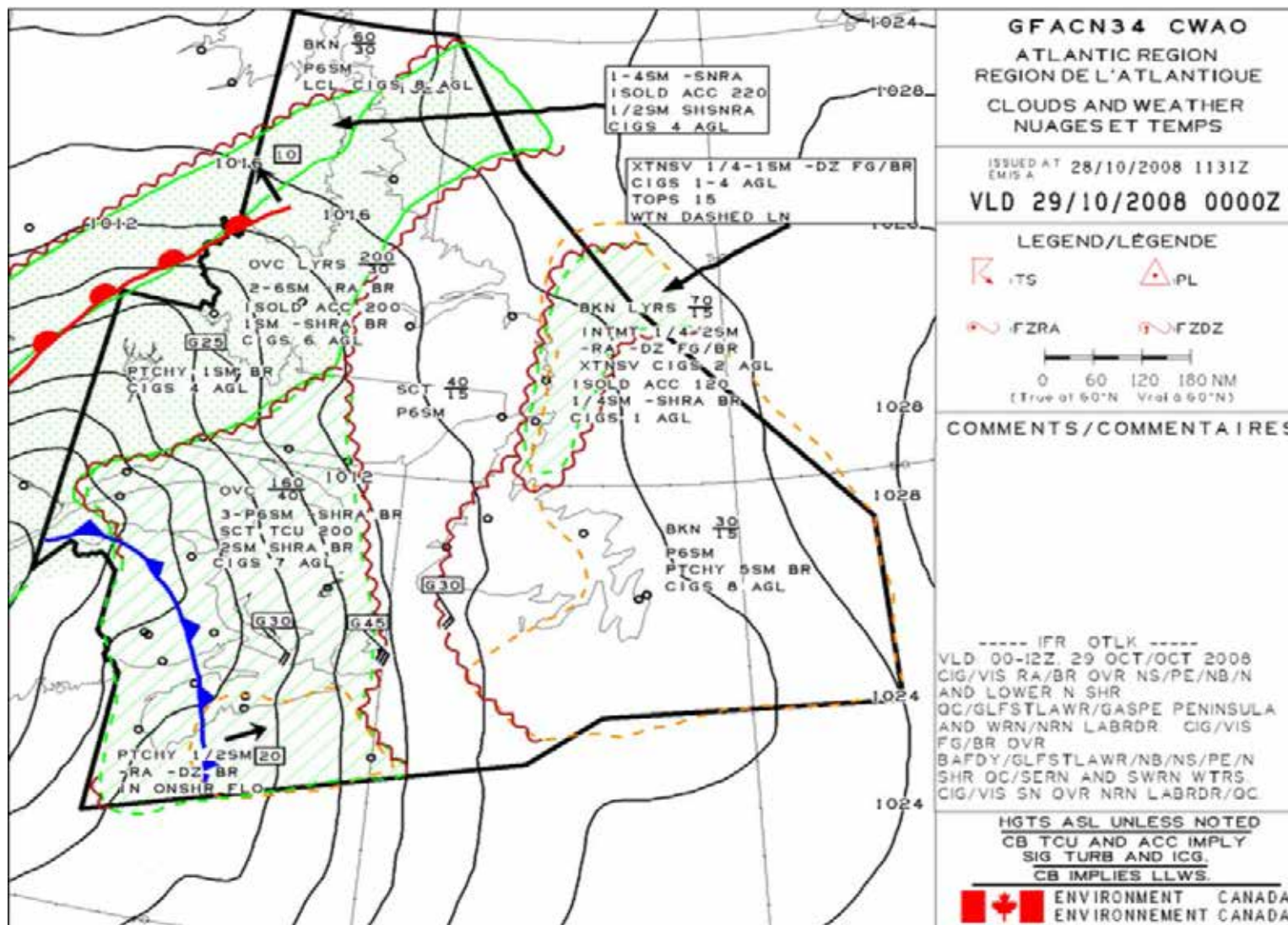

Figure F-1 GFA Clouds and Weather Chart

Note. From Nav Canada, 2007, *Aviation Weather Website*. Retrieved October 28, 2008, from http://www.flightplanning.navcanada.ca/cgi-bin/CreePage.pl?Langue=anglais&NoSession=NS_Inconnu&Page=forecast-observation&TypeDoc=html

THIS PAGE INTENTIONALLY LEFT BLANK

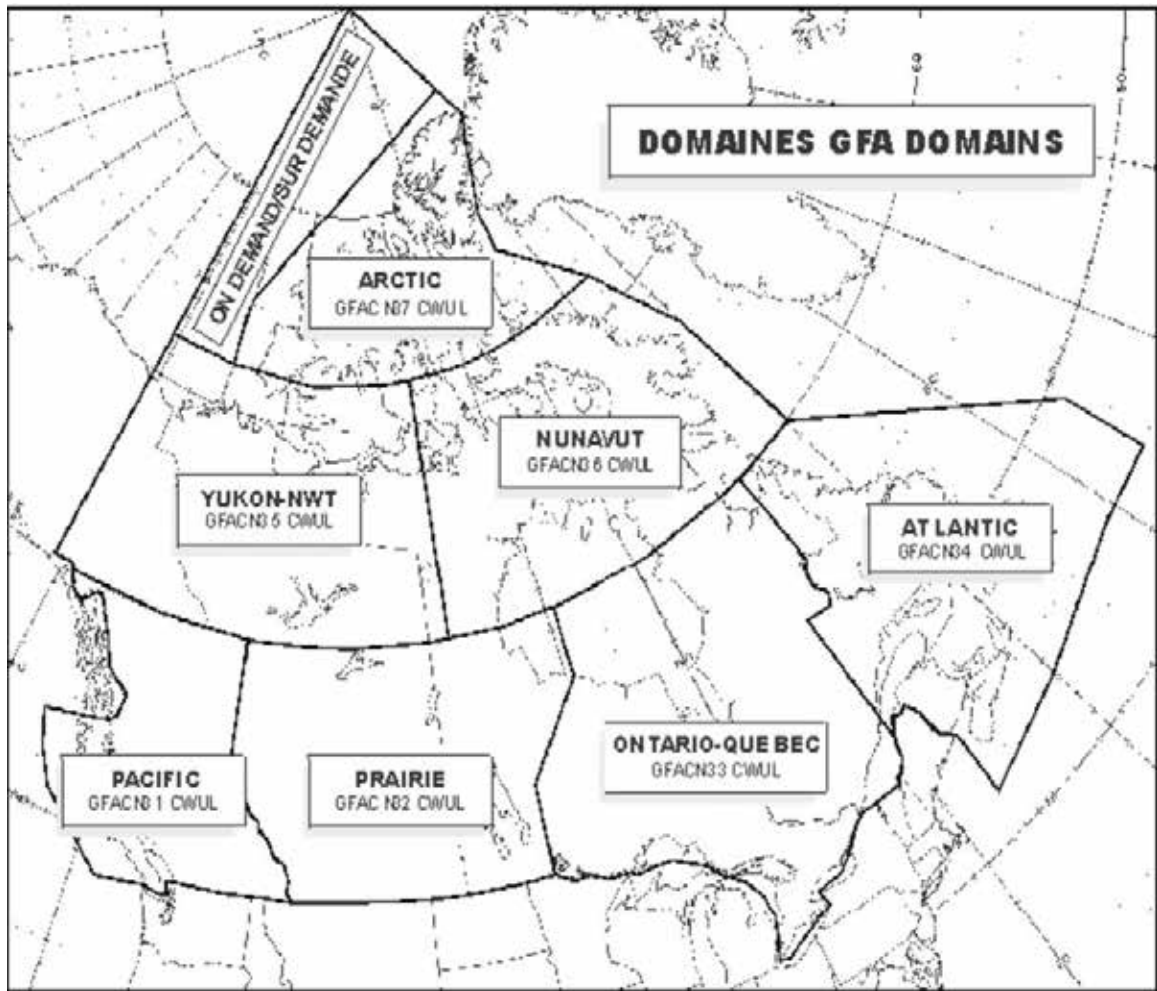

Figure G-1 GFA Domains

Note. From *Aeronautical Information Manual*, by Transport Canada, 2008, Retrieved October 27, 2008, from <http://www.tc.gc.ca/publications/EN/TP14371/PDF/HR/TP14371E.PDF>

THIS PAGE INTENTIONALLY LEFT BLANK

3.6 ABBREVIATIONS – AVIATION FORECASTS

CONTRACTION	PLAIN LANGUAGE	CONTRACTION	PLAIN LANGUAGE
ABV	above	CLRG	clearing
ACCAS	altocumulus castellanus	CNTR	centre
ACRS	across	CNTRD	centred
ACSL	standing lenticular altocumulus	CONDS	conditions
ACT	active	COTRAILS	condensation trails
AFT	after	CONTUS	continuous
AFL	above freezing layer	CONTG	continuing
AHD	ahead	CST	coast
ALF	aloft	CU	cumulus
ALG	along	DCRG	decreasing
ALT	altitude	DEG	degree
AIRMS	air mass	DFUS	diffuse
APCH	approach	DIST	distant
APCHG	approaching	DNS	dense
ASL	above sea level	DNSLP	downslope
AWOS	Automated Weather Observation System	DP	deep
BECMG	becoming	DPNG	deepening
BFR	before	DRFTG	drifting
BGN	begin	DURG	during
BGNG	beginning	DVLPG	developing
BHND	behind	DZ	drizzle
BKN	broken	E	east
BL	blowing	ELSW	elsewhere
BLDG	building	ELY	easterly
BLO	below	EMBD	embed
BLZD	blizzard	ENDG	ending
BDRY	boundary	ENTR	entire
BR	mist	FCST	forecast
BRF	brief	FEW	few clouds
BRFLY	briefly	FG	fog
BRKS	breaks	FILG	filling
BTN	between	FLWD	followed
CAT	clear air turbulence	FLWG	following
CAVOK	ceiling and visibility OK	FM	from
CB	cumulonimbus	FNT	front
CIG	ceiling	FRQ	frequent
CLD	cloud	FZLVL	freezing level
CLR	clear	FROIN	frost on indicator
		FROPA	frontal passage
		FRO	frequent

Figure H-1 Abbreviations

Note. From *Aeronautical Information Manual*. by Transport Canada, 2008, Retrieved October 27, 2008, from <http://www.tc.gc.ca/publications/EN/TP14371/PDF/HR/TP14371E.PDF>

CONTRACTION	PLAIN LANGUAGE	CONTRACTION	PLAIN LANGUAGE
FT	feet, foot	MDFYD	modified
FU	smoke	MDT	moderate
FZ	freezing	MI	shallow
GND	ground	MID	middle
GRAD	gradient	MOVG	moving
GRDLY	gradually	MPH	miles per hour
HGT	height	MRNG	morning
HI	high	MRTM	maritime
HLTP	hilltop	MSTR	moisture
HND	hundred	MTS	mountains
HR	hour	MVFR	marginal VFR
HVY	heavy	MXD	mixed
ICG	icing	MXG	mixing
ICGIC	icing in cloud	N	north
ICGIP	icing in precipitation	NE	northeast
IMDTLY	immediately	NELY	northeasterly
INCRG	increasing	NGT	night
INDEF	indefinite	NLY	northerly
INSTBY	instability	NM	nautical mile(s)
INTMT	intermittent	NMRS	numerous
INTS	intense	NR	near
INTSFY	intensify	NRLY	nearly
ISLD	island	NSW	no significant weather
ISOL	isolate(d)	NW	northwest
KT	knot(s)	NWLY	northwesterly
LCL	local	OBSC	obscure(d)
LFTG	lifting	OCLD	occlude
LGT	light	OCLDG	occluding
LIFR	low IFR	OCLN	occlusion
LK	lake	OCNL	occasional
LLJ	low level jet stream	OCNLY	occasionally
LLWS	low level wind shear	OFSHR	offshore
LN	line	ONSHR	onshore
LO	low	ORGPLC	orographic
LTL	little	OTLK	outlook
LVL	level	OTWZ	otherwise
LWIS	limited weather information system	OVC	overcast
LWR	lower	OVR	over
LWRG	lowering	OVRNG	overrunning
LYR	layer	PCPN	precipitation

Figure H-2 Abbreviations

Note. From *Aeronautical Information Manual*. by Transport Canada, 2008, Retrieved October 27, 2008, from <http://www.tc.gc.ca/publications/EN/TP14371/PDF/HR/TP14371E.PDF>

CONTRACTION	PLAIN LANGUAGE	CONTRACTION	PLAIN LANGUAGE
PD	period	SPECI	special
PL	ice pellets	SPRDG	spreading
PRECDD	preceded	SQ	squall
PRECDS	precedes	STBL	stable
PRES	pressure	STG	strong
PROG	prognostic, prognosis	STGTN	strengthen
PRSTG	persisting	STNRY	stationary
PSG	passage, passing	SEV	severe
PSN	position	SVRL	several
PTCHY	patchy	SW	southwest
PTLY	partly	SWLY	southwesterly
RA	rain	SXN	section
RDG	ridge	SYS	system
RFRMG	reforming	T	temperature
RGN	region	TCU	towering cumulus
RMNG	remaining	TEMPO	temporary
RPDLY	rapidly	THK	thick
RPRT	report	THKNG	thickening
RSG	rising	THN	thin
RUF	rough	THNC	thence
RVR	river	THNG	thinning
S	south	THRU	through
SCT	scattered	THRUT	throughout
SCTR	sector	THSD	thousand
SE	southeast	TILL	until
SELY	southeasterly	TRML	terminal
SFC	surface	TROF	trough
SH	shower	TROWAL	trough of warm air aloft
SHFT	shift	TRRN	terrain
SHFTG	shifting	TS	thunderstorm
SHLW	shallow	TURB	turbulence
SKC	sky clear	TWD	toward
SLO	slow	UNSTBL	unstable
SLOLY	slowly	UPR	upper
SLY	southerly	UPSLP	upslope
SM	statute mile(s)	UTC	co-ordinated universal time
SML	small	VC	vicinity
SN	snow	VLY	valley
SNRS	sunrise	VRB	variable
SNST	sunset	VIS	visibility

Figure H-3 Abbreviations

Note. From *Aeronautical Information Manual*. by Transport Canada, 2008, Retrieved October 27, 2008, from <http://www.tc.gc.ca/publications/EN/TP14371/PDF/HR/TP14371E.PDF>

CONTRACTION	PLAIN LANGUAGE
VV	vertical visibility
W	west
WDLY	widely
WK	weak
WLY	westerly
WND	wind
WRM	warm
WS	wind shear
WV	wave
WX	weather
XCP	except
XT	extend
XTDG	extending
XTRM	extreme
XTSV	extensive
Z	ZULU (or UTC)

Figure H-4 Abbreviations

Note. From *Aeronautical Information Manual*. by Transport Canada, 2008, Retrieved October 27, 2008, from <http://www.tc.gc.ca/publications/EN/TP14371/PDF/HR/TP14371E.pdf>

GFA Weather Symbols

	TS	Thunderstorm
	PL	Ice Pellets
	FZRA	Freezing Rain
	FZDZ	Freezing Drizzle

Figure I-1 Weather Symbols

Note. Created by Director Cadets 3, 2008, Ottawa, ON: Department of National Defence.

THIS PAGE INTENTIONALLY LEFT BLANK

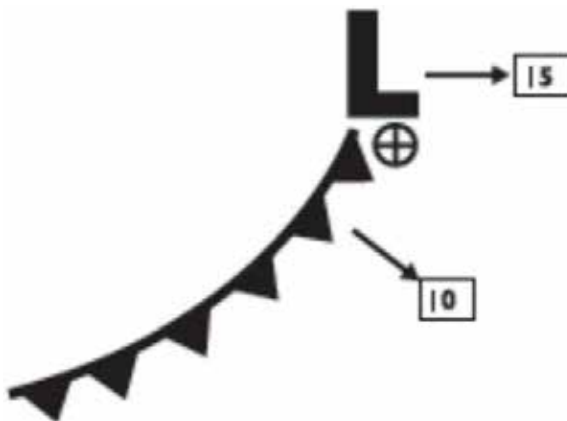

Figure J-1 Synoptic Features

Note. From *Aeronautical Information Manual*. by Transport Canada, 2008, Retrieved October 27, 2008, from <http://www.tc.gc.ca/publications/EN/TP14371/PDF/HR/TP14371E.PDF>

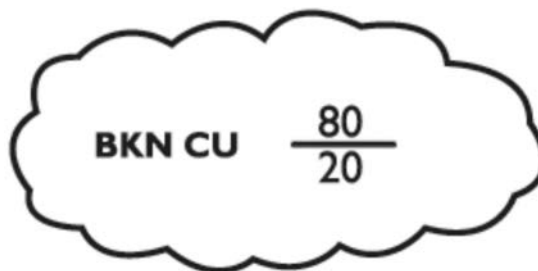

Figure J-2 Broken Cumulus Clouds

Note. From *Aeronautical Information Manual*. by Transport Canada, 2008, Retrieved October 27, 2008, from <http://www.tc.gc.ca/publications/EN/TP14371/PDF/HR/TP14371E.PDF>

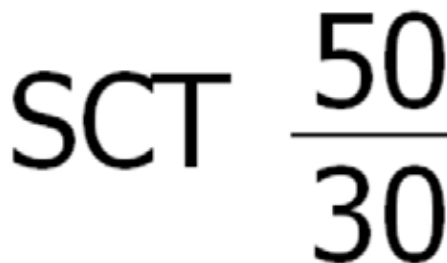

Figure J-3 Scattered Clouds

Note. From *Aeronautical Information Manual*. by Transport Canada, 2008, Retrieved October 27, 2008, from <http://www.tc.gc.ca/publications/EN/TP14371/PDF/HR/TP14371E.PDF>

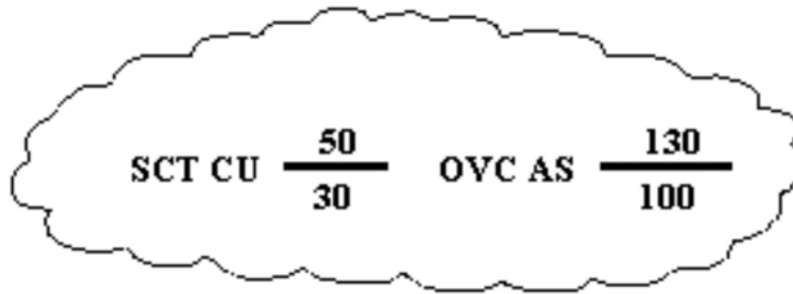

Figure J-4 Multiple Cloud Layers

Note. From *Aeronautical Information Manual*, by Transport Canada, 2008, Retrieved October 27, 2008, from <http://www.tc.gc.ca/publications/EN/TP14371/PDF/HR/TP14371E.PDF>

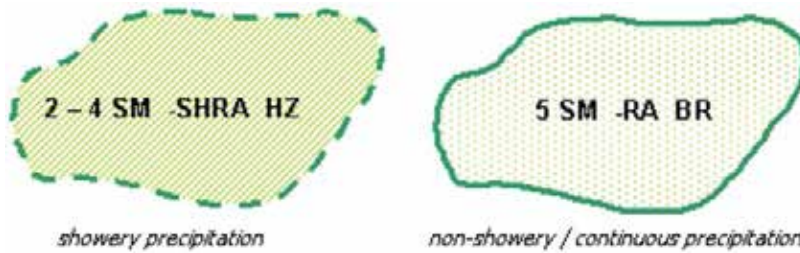

Figure J-5 Weather and Obstructions to Vision

Note. From Nav Canada, 2007, *Aviation Weather Website*. Retrieved October 28, 2008, from http://www.flightplanning.navcanada.ca/cgi-bin/CreePage.pl?Page=info-gfa&NoSession=NS_Inconnu&TypeDoc=gfa&Langue=anglais#abbr_symb

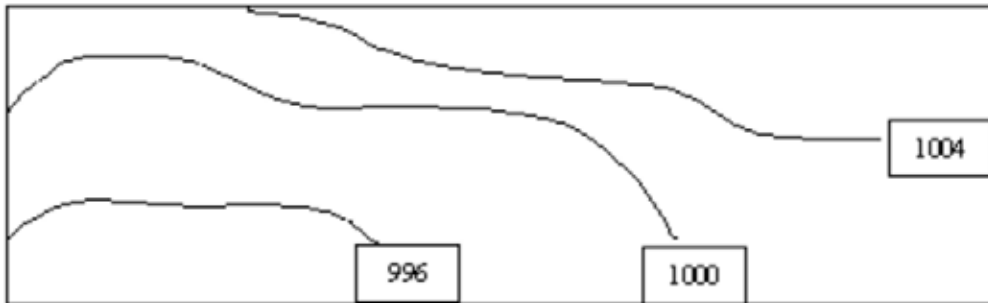

Figure J-6 Isobars

Note. From Nav Canada, 2007, *Aviation Weather Website*. Retrieved October 28, 2008, from http://www.flightplanning.navcanada.ca/cgi-bin/CreePage.pl?Page=info-gfa&NoSession=NS_Inconnu&TypeDoc=gfa&Langue=anglais#abbr_symb



Figure J-7 Surface Winds

Note. From *Aeronautical Information Manual*, by Transport Canada, 2008, Retrieved October 27, 2008, from <http://www.tc.gc.ca/publications/EN/TP14371/PDF/HR/TP14371E.PDF>



ROYAL CANADIAN AIR CADETS
PROFICIENCY LEVEL FOUR
INSTRUCTIONAL GUIDE



SECTION 1

EO M437.01 – DEFINE AIR NAVIGATION TERMS

Total Time:

60 min

PREPARATION

PRE-LESSON INSTRUCTIONS

Resources needed for the delivery of this lesson are listed in the lesson specification located in A-CR-CCP-804/PG-001, *Proficiency Level Four Qualification Standard and Plan*, Chapter 4. Specific uses for said resources are identified throughout the instructional guide within the TP for which they are required.

Review the lesson content and become familiar with the material prior to delivering the lesson.

Photocopy the handout located at Attachment A for each cadet.

Prepare slides of the figures located at Attachment B.

Photocopy the Headings and Bearings Worksheet located at Attachment C for each cadet.

PRE-LESSON ASSIGNMENT

Nil.

APPROACH

An interactive lecture was chosen for TPs 1–3 to clarify, emphasize, and summarize navigation terms.

An in-class activity was chosen for TP 4 as it is an interactive way to reinforce bearings and headings, and confirm the cadets' comprehension of navigation terms.

INTRODUCTION

REVIEW

Nil.

OBJECTIVES

By the end of this lesson the cadet shall be expected to define air navigation terms.

IMPORTANCE

It is important for cadets to define air navigation terms to ensure a firm foundation in navigation before learning more advanced material. Knowledge of air navigation terms is essential for future aviation training and potential instructional duties at the squadron.

Teaching Point 1

Define meridians of longitude, parallels of latitude, geographical co-ordinates, and the relationship between time and longitude.

Time: 25 min

Method: Interactive Lecture



Use a large globe to point out the meridians of longitude and parallels of latitude.

MERIDIANS OF LONGITUDE

Meridians of longitude. Semicircles joining the true / geographic poles of the Earth.

Longitude is measured from 0–180 degrees east and west of the prime meridian. The prime meridian is the meridian which passes through Greenwich, England and is numbered zero degrees. The meridian on the opposite side of the Earth to the prime meridian is the 180th and is called the international date line (the time changes a day).

Longitude is measured in degrees (°), minutes ('), and seconds ("). There are 60 minutes in a degree and 60 seconds in a minute.



When dealing with longitude and latitude, seconds and minutes are not measurements of time but rather divisions of a degree. This can be compared to the way that a metre is divided into 100 cm and each centimetre is divided into 10 mm.

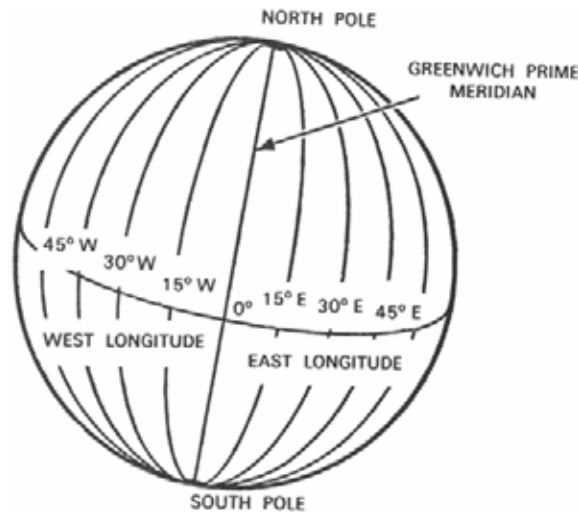

Figure 1 Meridians of Longitude

Note. From "Air Cadet Master Lesson Plans", 2007, *Cadets Canada: RCSU Pacific*. Retrieved November 14, 2007, from http://www.regions.cadets.ca/pac/aircad/resources/mlp_air_e.asp

PARALLELS OF LATITUDE

Parallels of latitude. Circles on the Earth's surface that lie parallel to the equator.

Equator. An imaginary line on the surface of the Earth equidistant from the poles.

Latitude is measured from 0–90 degrees north and south of the equator, which is numbered zero degrees. Like longitude, latitude is measured in degrees, minutes, and seconds.

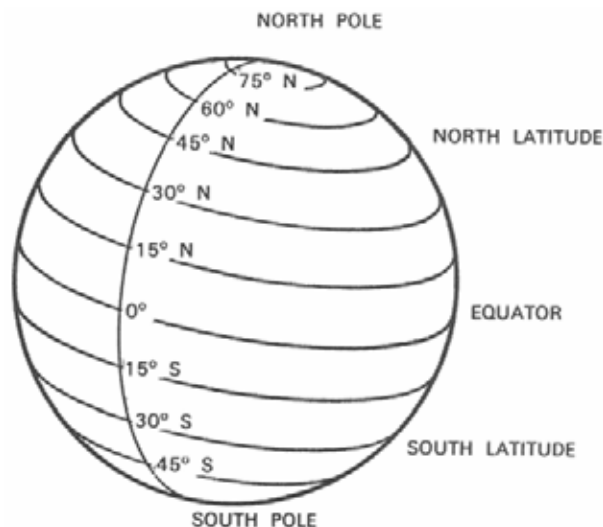

Figure 2 Parallels of Latitude

Note. From "Air Cadet Master Lesson Plans", 2007, *Cadets Canada: RCSU Pacific*. Retrieved November 14, 2007, from http://www.regions.cadets.ca/pac/aircad/resources/mlp_air_e.asp



Remember the difference between latitude and longitude using one of the following mnemonics:

- Lat is flat / fat; longitude is long.
- Latitude is like climbing up a ladder because it is north / south; longitude is like swinging across because it is east / west.

GEOGRAPHICAL CO-ORDINATES

Geographical co-ordinates. The intersection of lines of latitude and longitude. Geographical co-ordinates mark the position of places (eg, cities, towns, airports) on a chart.

On a chart, there are black lines representing longitude and latitude, every 30 minutes. Small marks represent 1 minute. There are slightly larger marks for 5 minute and 10 minute increments.



Distribute the handout located at Attachment A to each cadet.

Have the cadets find markings on a line of latitude or longitude to represent 1 minute, 5 minutes, and 10 minutes using a local VFR Navigation Chart (VNC).

Co-ordinates express latitude first, in degrees north or south of the equator and longitude second, in degrees east or west of the prime meridian. For example, the geographical coordinates of the military airport at Trenton, Ont. are 44°07' N, 77°32' W.



The location of the military airport at Trenton, Ont. has been chosen as an example because it appears on the sample VNC provided in the back of *From The Ground Up: Millennium Edition*.

The grid surrounding this airport can be found at Attachment A.



Select a major airport in the area and have the cadets find the coordinates using a local VNC.

THE RELATIONSHIP BETWEEN TIME AND LONGITUDE

The Earth rotates about its axis as it revolves in an elliptical orbit around the Sun. This creates the illusion that the Sun is revolving around the Earth. The time between one apparent passage of the Sun over a meridian of longitude is called an apparent solar day and varies throughout the year. To provide a convenient method of measuring time, it has been averaged to a mean solar day, divided into 24 hours. During the mean solar day, the Sun is assumed to travel once around the Earth, thereby travelling through 360 degrees of longitude. Hence, mean time can be expressed in terms of longitude and vice versa.

For example:

- 24 hours = 360 degrees of longitude
- 1 hour = 15 degrees of longitude
- 1 minute = 15 minutes of longitude
- 1 second = 15 seconds of longitude
- 360 degrees of longitude = 24 hours
- 1 degree of longitude = 4 minutes
- 1 minute of longitude = 4 seconds
- 1 second of longitude = 1/15 second

Local mean time (LMT). The mean time on any particular meridian.

Co-ordinated universal time (UTC). An atomically measured global standard time, calculated from midnight on the zero meridian. UTC is also referred to as Zulu (Z) time.



UTC replaced Greenwich mean time (GMT) which was the universally accepted standard for the measurement of time until December, 1985.

UTC is the LMT for the prime meridian.

The LMT of any place east of the prime meridian is ahead of UTC. For example, 1200 hours LMT in Cairo is 1000Z.

The LMT of any place west of the prime meridian is behind UTC. For example, 1200 hours LMT in Halifax is 1600Z.



Tell the cadets how many hours are added to LMT to find UTC in their location.



Use a large globe to indicate the time zones.

The world is divided into 24 time zones, each 15 degrees of longitude (one hour) wide. When travelling westward into a new time zone, time is turned back one hour. When travelling eastward into a new time zone, time is turned ahead one hour.



One exception to this is Newfoundland Standard Time, which is 1/2 hour ahead of Atlantic Standard Time.

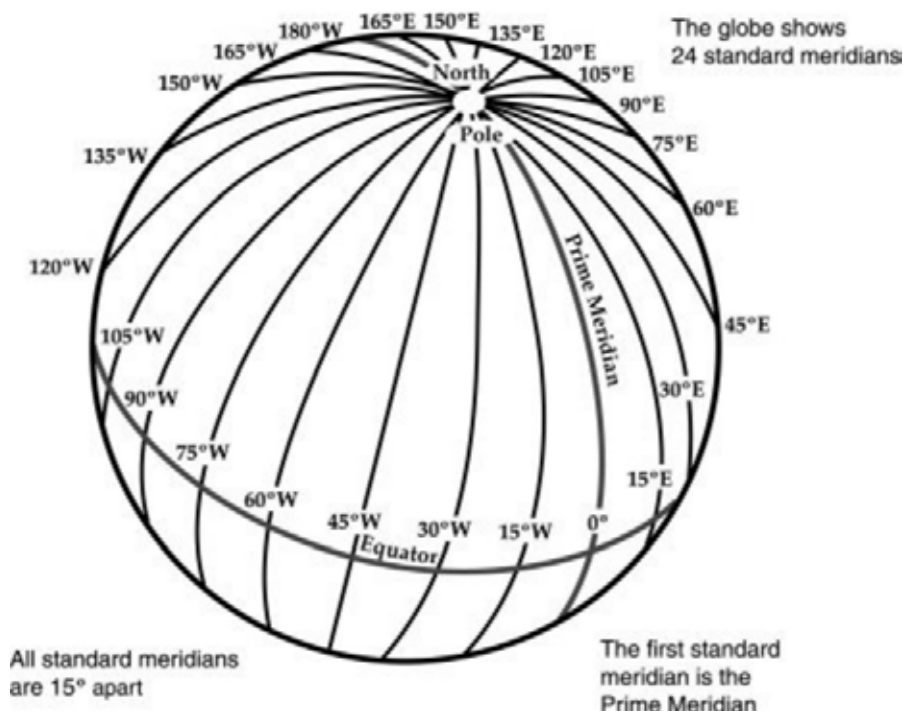

Figure 3 Meridians of Longitude

Note. From "Globe Lesson 12", *1-World Maps Online*, Copyright 2008 by 1-World Maps Online. Retrieved November 25, 2008, from <http://www.worldmapsonline.com/LESSON-PLANS/6-global-time-globe-lesson-12.htm>



Part of our heritage: Sir Sandford Fleming, a Canadian railway planner and engineer, outlined a plan for worldwide standard time in the late 1870s. Following this initiative, in 1884, delegates from 27 nations met in Washington, D.C. for the Meridian Conference and agreed on a system basically the same as that now in use.

CONFIRMATION OF TEACHING POINT 1

QUESTIONS:

- Q1. What are meridians of longitude?
- Q2. How are parallels of latitude measured?
- Q3. What must be done to LMT in Canada to convert it to UTC?

ANTICIPATED ANSWERS:

- A1. Semicircles joining the true / geographic poles of the Earth.
- A2. From 0–90 degrees north and south of the equator.
- A3. The appropriate number of hours must be added.

Teaching Point 2

Define great circles and rhumb lines.

Time: 10 min

Method: Interactive Lecture

GREAT CIRCLES



Show the slide of Figures B-1 and B-2 to the cadets.

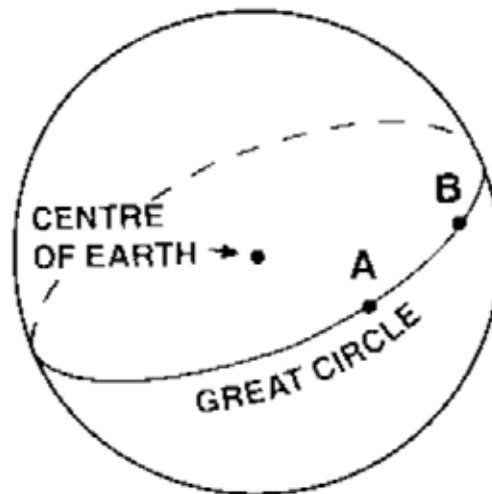

Figure 4 Great Circle

Note. From From the Ground Up: Millennium Edition (p. 177), by A. F. MacDonald and I. L. Pepler, 2000, Ottawa, ON: Aviation Publishers Co. Limited. Copyright 2000 by Aviation Publishers Co. Limited.

Great circle. A circle on the surface of a sphere that passes through the centre of the sphere, cutting it into two equal parts.

The equator is a great circle. The meridians of longitude are semi-great circles as they run from pole to pole and do not completely encircle the Earth.

Only one great circle can be drawn through two places that are not diametrically opposite each other. The shortest distance between these two points is the shorter arc of the great circle joining them. Therefore, most long-distance flights are flown over great circle routes.

A great circle does not cross the meridians it meets at the same angle. Therefore, the heading must be changed at frequent intervals to enable the airplane to maintain a great circle route.

RHUMB LINES



Show the slide of Figures B-3 and B-4 to the cadets.

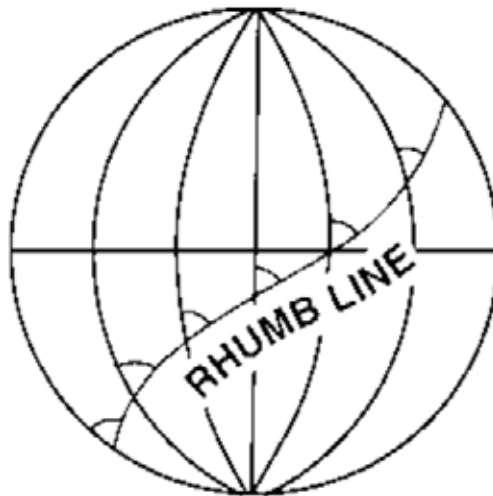

Figure 5 Rhumb Line

Note. From *From the Ground Up: Millennium Edition* (p. 177), by A. F. MacDonald and I. L. Pepler, 2000, Ottawa, ON: Aviation Publishers Co. Limited. Copyright 2000 by Aviation Publishers Co. Limited.

Rhumb line. A curved line on the surface of the Earth, cutting all the meridians it meets at the same angle.

All parallels of latitude are rhumb lines. The meridians of longitude and the equator are rhumb lines as well as great circles.



Show the slide of Figures B-5 and B-6 to the cadets.

When two places are not situated on the equator or on the same meridian of longitude, the distance measured along the rhumb lines joining them will not be the shortest distance between them. The advantage of the rhumb line route is that the direction is constant, allowing a navigator to follow a constant heading.



Figure 6 Great Circle and Rhumb Line

Note. From "Flights", *Navworld*. Retrieved November 26, 2008, <http://www.navworld.com/navcerebrations/flights.htm>

CONFIRMATION OF TEACHING POINT 2

QUESTIONS:

- Q1. What is a great circle?
- Q2. What is a rhumb line?
- Q3. What is the advantage of following a rhumb line route?

ANTICIPATED ANSWERS:

- A1. A circle on the surface of a sphere that passes through the centre of the sphere, cutting it into two equal parts.
- A2. A curved line on the surface of the Earth, cutting all the meridians it meets at the same angle.
- A3. The direction is constant, allowing a navigator to follow a constant heading.

Teaching Point 3

Define headings and bearings.

Time: 5 min

Method: Interactive Lecture

HEADINGS AND BEARINGS

Direction is measured in degrees clockwise from north, which is zero degrees (or 360 degrees). East is 90 degrees, south is 180 degrees, and west is 270 degrees.



Show the slide of Figure B-7 to the cadets.



Figure 7 Heading

Note. From *From the Ground Up: Millennium Edition* (p. 177), by A. F. MacDonald and I. L. Peppler, 2000, Ottawa, ON: Aviation Publishers Co. Limited. Copyright 2000 by Aviation Publishers Co. Limited.

True heading. The angle between the meridian of longitude over which an airplane is flying and the line representing the direction the airplane's nose is pointing, measured clockwise from the meridian.



Show the slide of Figure B-8 to the cadets.

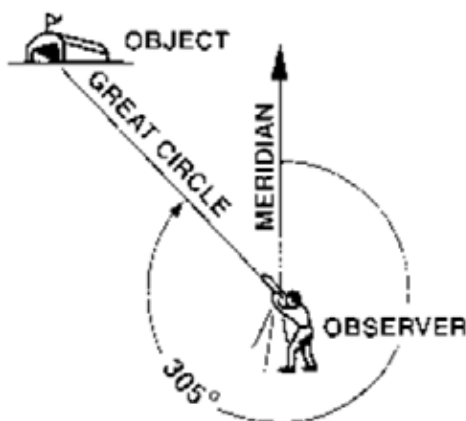

Figure 8 Bearing

Note. From *From the Ground Up: Millennium Edition* (p. 177), by A. F. MacDonald and I. L. Peppler, 2000, Ottawa, ON: Aviation Publishers Co. Limited. Copyright 2000 by Aviation Publishers Co. Limited.

The direction of any point on the surface of the Earth from an observer is known by measuring the bearing.

Bearing. The angle between the meridian of longitude passing through the observer and the great circle that joins the observer to the object, measured clockwise from the meridian.

Headings and bearings are found using a compass.

CONFIRMATION OF TEACHING POINT 3

QUESTIONS:

- Q1. How is direction measured?
- Q2. Define true heading.
- Q3. Define bearing.

ANTICIPATED ANSWERS:

- A1. In degrees clockwise from north.
- A2. The angle between the meridian of longitude over which an airplane is flying and the line representing the direction the airplane's nose is pointing, measured clockwise from the meridian.
- A3. The angle between the meridian of longitude passing through the observer and the great circle that joins the observer to the object, measured clockwise from the meridian.

Teaching Point 4

Have the cadets take headings and bearings.

Time: 10 min

Method: In-Class Activity

ACTIVITY

OBJECTIVE

The objective of this activity is to have the cadets take headings and bearings.

RESOURCES

- Douglas Protractor,
- Pen / Pencil, and
- Headings and Bearings Worksheet located at Attachment C.

ACTIVITY LAYOUT

Nil.

ACTIVITY INSTRUCTIONS

1. Distribute a Douglas protractor to each cadet.
2. Distribute a Headings and Bearings Worksheet to each cadet.
3. Designate an object in the room as representing magnetic north.
4. Have the cadets take the magnetic headings of the aircraft in Section 1 of the worksheet.

5. Review and correct the answers.
6. Designate a different object in the room as representing true north.
7. Have the cadets take the bearing of the tower from the aircraft in Section 2 of the worksheet.
8. Review and correct the answers.

SAFETY

Nil.

CONFIRMATION OF TEACHING POINT 4

The cadets' participation in the activity will serve as the confirmation of the TP.

END OF LESSON CONFIRMATION**QUESTIONS:**

- Q1. How many degrees of longitude are equal to one hour?
- Q2. What is the shortest distance between two places on the surface of the Earth?
- Q3. How are headings and bearings found?

ANTICIPATED ANSWERS:

- A1. Fifteen.
- A2. The shorter arc of the great circle joining them.
- A3. Using a compass.

CONCLUSION

HOMEWORK / READING / PRACTICE

Nil.

METHOD OF EVALUATION

This EO is assessed IAW A-CR-CCP-804/PG-001, *Proficiency Level Four Qualification Standard and Plan*, Chapter 3, Annex B, Aviation Subjects–Combined Assessment PC.

CLOSING STATEMENT

Future aviation training and instructional duties require knowledge of air navigation terms.

INSTRUCTOR NOTES / REMARKS

Cadets who are qualified Advanced Aviation may assist with this instruction.

REFERENCES

C3-116 ISBN 0-9680390-5-7 MacDonald, A. F., & Peppler, I. L. (2000). *From the ground up: Millennium edition*. Ottawa, ON: Aviation Publishers Co. Limited.

THIS PAGE INTENTIONALLY LEFT BLANK

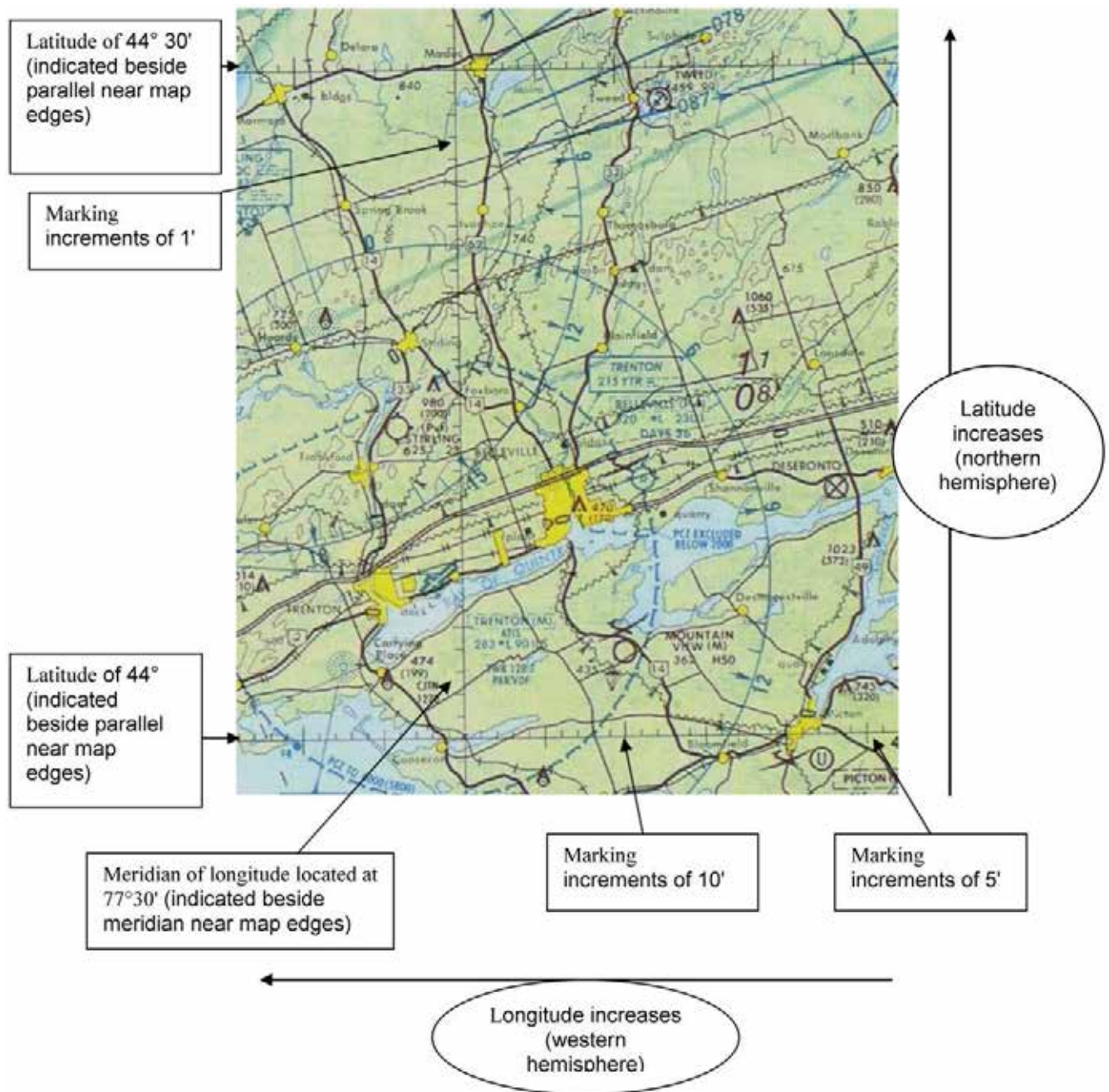

Figure A-1 Example of a VNC

Note. From *Trenton VFR Navigation Chart*, by Geomatics Canada, 2001, Ottawa, ON: Geomatics Canada Department of Natural Resources. Copyright 2001 by NAV CANADA and Her Majesty the Queen in Right of Canada.

THIS PAGE INTENTIONALLY LEFT BLANK

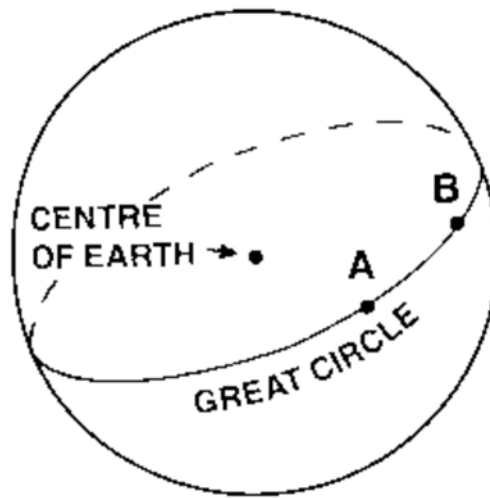

Figure B-1 Great Circle

Note. From *From the Ground Up: Millennium Edition* (p. 177), by A. F. MacDonald and I. L. Pepler, 2000, Ottawa, ON: Aviation Publishers Co. Limited. Copyright 2000 by Aviation Publishers Co. Limited.

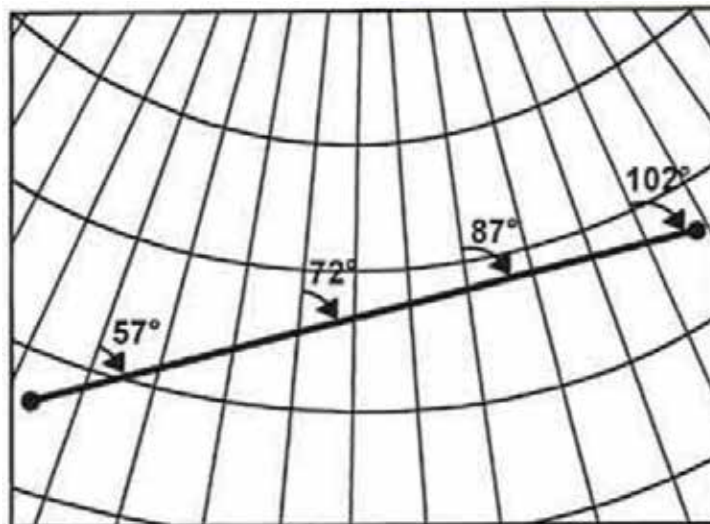

Figure B-2 Great Circle

Note. From "Navigation Basics", *Free Online Private Pilot Ground School*. Retrieved November 26, 2008, <http://www.free-online-private-pilot-ground-school.com/navigation-basics.html>

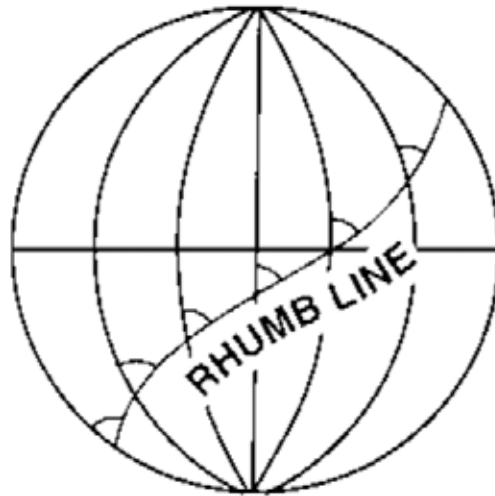

Figure B-3 Rhumb Line

Note. From *From the Ground Up: Millennium Edition* (p. 177), by A. F. MacDonald and I. L. Peppler, 2000, Ottawa, ON: Aviation Publishers Co. Limited. Copyright 2000 by Aviation Publishers Co. Limited.

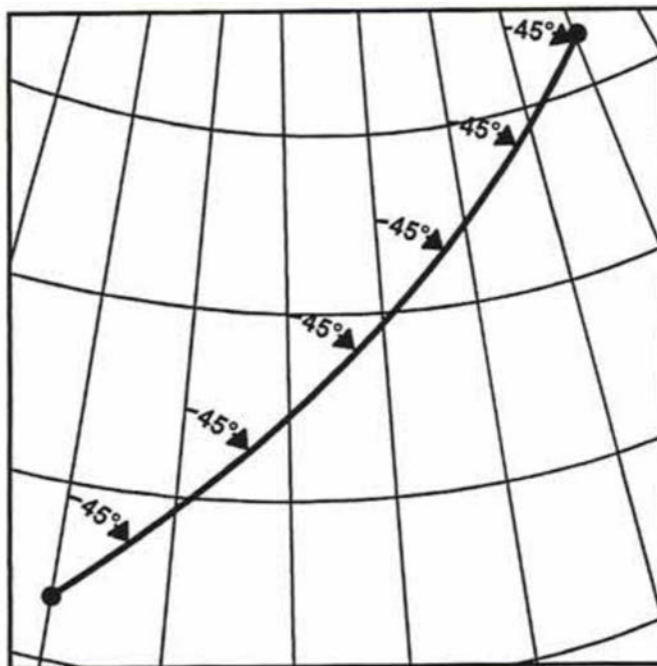

Figure B-4 Rhumb Line

Note. From "Navigation Basics", *Free Online Private Pilot Ground School*. Retrieved November 26, 2008, <http://www.free-online-private-pilot-ground-school.com/navigation-basics.html>

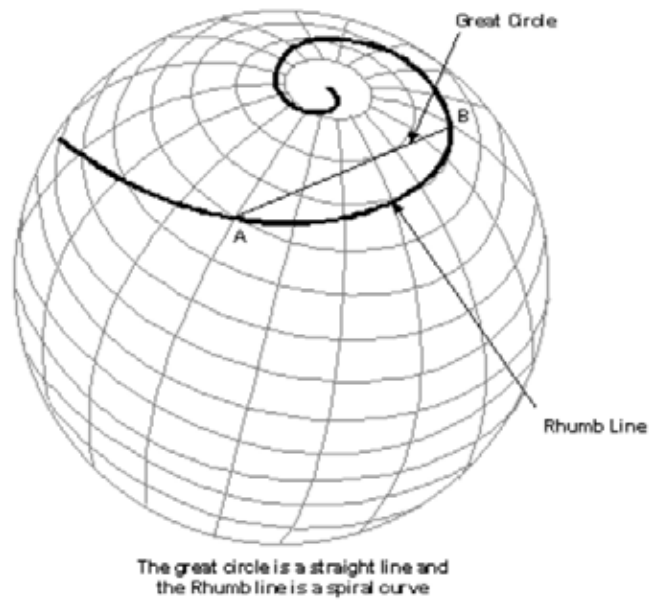

Figure B-5 Great Circle and Rhumb Line

Note. From "Flights", *Navworld*. Retrieved November 26, 2008, <http://www.navworld.com/navcerebrations/flights.htm>

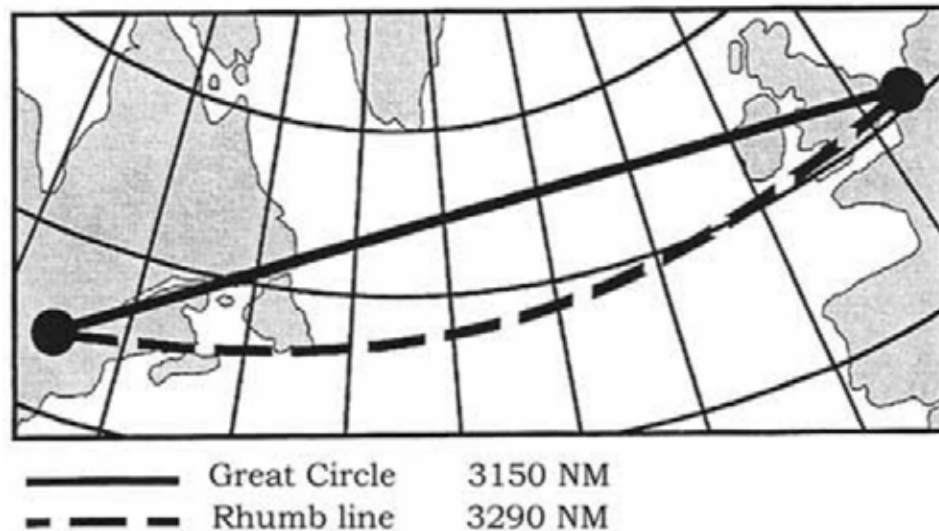

Figure B-6 Great Circle and Rhumb Line

Note. From "Navigation Basics", *Free Online Private Pilot Ground School*. Retrieved November 26, 2008, <http://www.free-online-private-pilot-ground-school.com/navigation-basics.html>

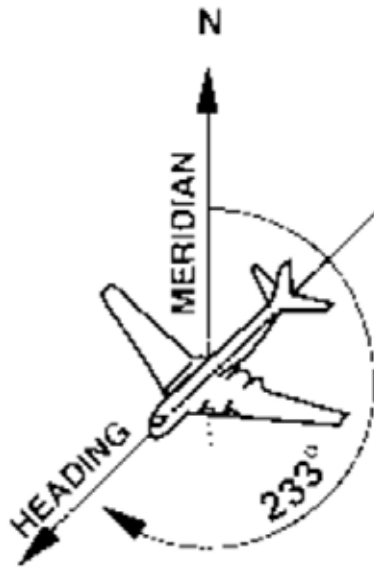

Figure B-7 Heading

Note. From *From the Ground Up: Millennium Edition* (p. 177), by A. F. MacDonald and I. L. Peppler, 2000, Ottawa, ON: Aviation Publishers Co. Limited. Copyright 2000 by Aviation Publishers Co. Limited.

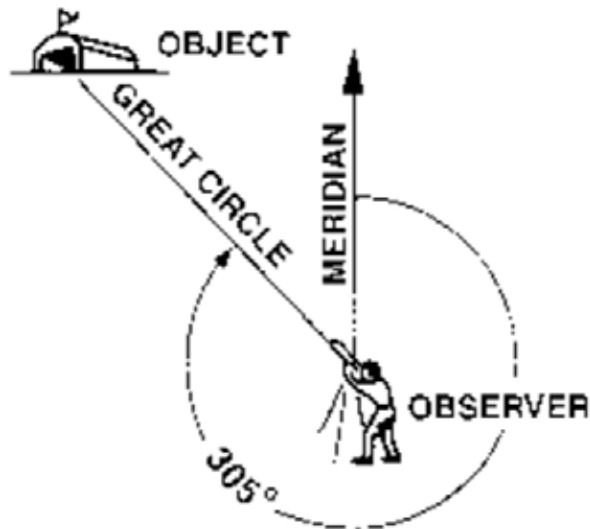

Figure B-8 Bearing

Note. From *From the Ground Up: Millennium Edition* (p. 177), by A. F. MacDonald and I. L. Peppler, 2000, Ottawa, ON: Aviation Publishers Co. Limited. Copyright 2000 by Aviation Publishers Co. Limited.

Headings and Bearings Worksheet

Section 1 – Take the Heading of Each Aircraft



Section 2 – Take the Bearing of the Tower from the Aircraft

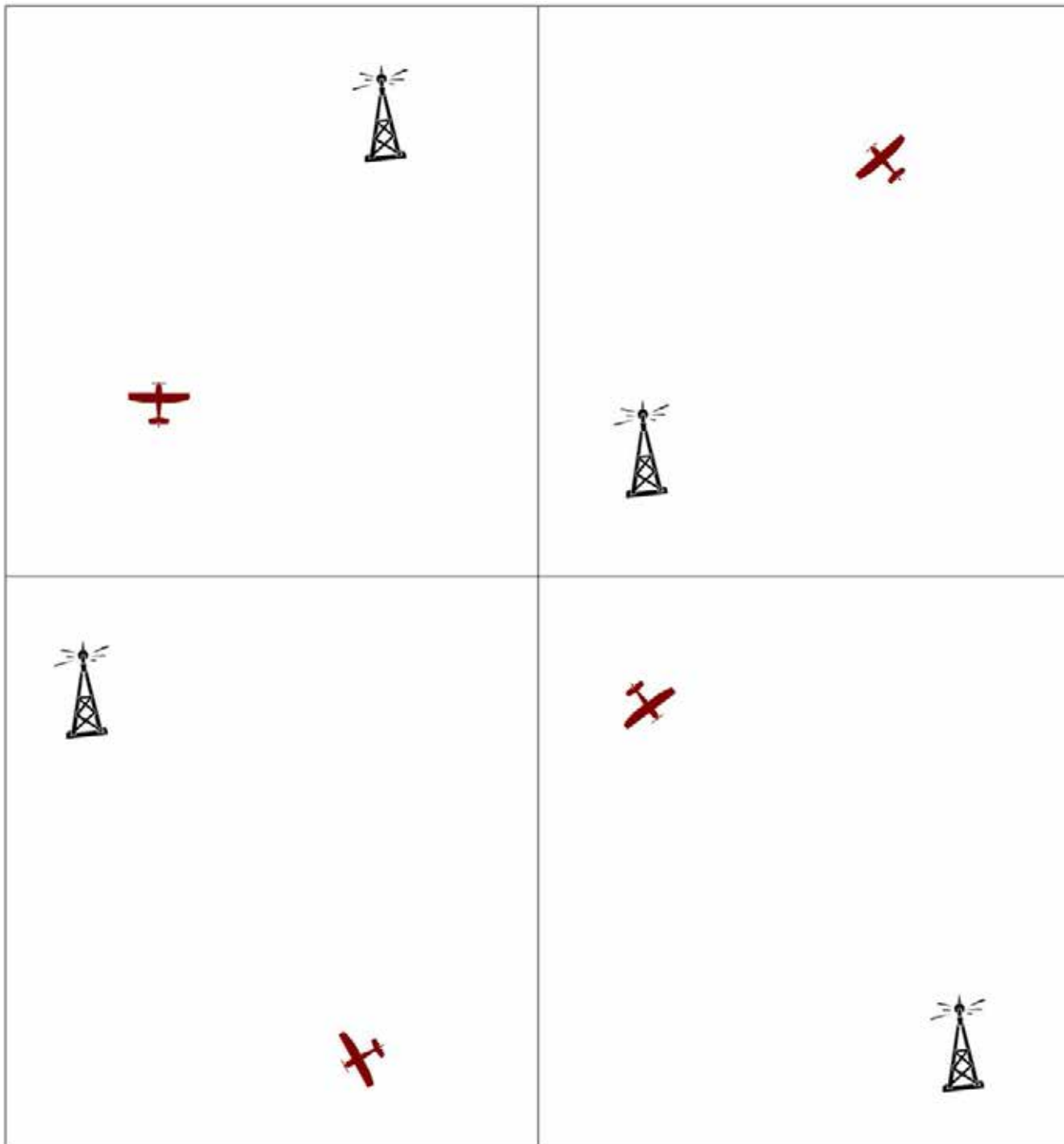



**ROYAL CANADIAN AIR CADETS
PROFICIENCY LEVEL FOUR
INSTRUCTIONAL GUIDE**



SECTION 2

EO M437.02 – DESCRIBE THE MAGNETIC COMPASS

Total Time:	30 min
-------------	--------

PREPARATION

PRE-LESSON INSTRUCTIONS

Resources needed for the delivery of this lesson are listed in the lesson specification located in A-CR-CCP-804/PG-001, *Proficiency Level Four Qualification Standard and Plan*, Chapter 4. Specific uses for said resources are identified throughout the instructional guide within the TP for which they are required.

Review the lesson content and become familiar with the material prior to delivering the lesson.

Prepare slides of the figures located at Attachment A.

Photocopy the homework assignment located at Attachment B for each cadet.

PRE-LESSON ASSIGNMENT

Nil.

APPROACH

An interactive lecture was chosen for this lesson to clarify, emphasize, and summarize the magnetic compass.

INTRODUCTION

REVIEW

Nil.

OBJECTIVES

By the end of this lesson the cadet shall be expected to describe the magnetic compass.

IMPORTANCE

It is important for the cadets to learn about the magnetic compass because the compass is a vital instrument used for navigation. The compass is often used as a reference for other instruments used in direction finding (such as the heading indicator). The cadets can apply this knowledge in a flight simulator and on a demonstration flight.

Teaching Point 1**Describe the Earth's magnetism.**

Time: 5 min

Method: Interactive Lecture

THE EARTH'S MAGNETISM

The Earth is a giant magnet that has a north and south pole. There are lines of force generated by currents of molten iron that flow within the Earth. The lines of force flow between the poles, creating a magnetic field that surrounds the Earth. The compass needle is affected by the lines of force, causing the magnetic needle to point to magnetic north.

Points of a Compass Rose

Show the slide of Figure A-1 to the cadets.

The main cardinal points are north, south, east, and west. The inter-cardinal points are northeast, southeast, southwest, and northwest.

CONFIRMATION OF TEACHING POINT 1**QUESTIONS:**

- Q1. Where does the magnetic needle point?
- Q2. What cardinal point does a bearing of 270 degrees represent?
- Q3. What is your heading (in degrees) if you are flying northeast?

ANTICIPATED ANSWERS:

- A1. Magnetic north.
- A2. West.
- A3. 45 degrees.

Teaching Point 2**Describe the main parts of the magnetic compass.**

Time: 5 min

Method: Interactive Lecture

MAIN PARTS OF THE MAGNETIC COMPASS

Show the slide of Figure A-2 to the cadets.

Point out the parts of a magnetic compass using the examples of magnetic compasses.

Lubber line. The lubber line is a painted white line that indicates the direction the airplane is heading. It is in line with or parallel to the longitudinal axis of the airplane. It is at this location that the compass card is read.

Compass card. The compass card contains the numbers. It is attached to the pivot and moves within the compass bowl. The compass card is read at the lubber line through a window.

Compass bowl. The compass bowl encompasses the entire compass assembly, including the liquid. The compass bowl is made of brass which is a non-magnetic material.

Pivot. The pivot allows the compass card to rotate freely.

Magnetic needle. The magnetic needle always points to magnetic north.

Liquid. The compass bowl is filled with liquid to lubricate the pivot, reduce the weight of the compass card and magnets, and limit movement that may be caused by turbulence. The liquid is either alcohol or white kerosene because they are transparent and have a low freezing point and a high boiling point.

CONFIRMATION OF TEACHING POINT 2

QUESTIONS:

- Q1. What does the lubber line indicate?
- Q2. What part of the compass contains the numbers that are read?
- Q3. What liquids are used in the compass bowl?

ANTICIPATED ANSWERS:

- A1. The direction the airplane is heading.
- A2. The compass card.
- A3. Alcohol or white kerosene.

Teaching Point 3

Describe variation.

Time: 5 min

Method: Interactive Lecture

VARIATION

True north and magnetic north do not have the same location. The two poles can be located far apart because magnetic north is continuously moving at a very slow rate. This is a significant concern for navigation because geographical coordinates are based on true or geographic north whereas a magnetic compass points to magnetic north.



Show the slide of Figure A-3 to the cadets.

Variation. Variation is the angle between true north and magnetic north. It is also known as magnetic declination. This angle is taken into consideration during flight planning.

Agonic lines. Agonic lines join places of zero magnetic variation. This is to say that both the true north and magnetic north lie in a straight line relative to these places.

Isogonic lines. Isogonic lines join places of equal magnetic variation. If an observer were to move along this invisible line, the angle between true and magnetic north would remain the same.



Aeronautical navigation charts use true north and display variation information. Pilots must convert the true headings to magnetic headings in order to navigate using the charts and magnetic compass.

The following rhymes can help pilots remember how to apply variation to true headings:

- "Variation West, Magnetic Best", and
- "Variation East, Magnetic Least".

In other words, ADD westerly variation to a true heading to calculate the magnetic heading. SUBTRACT easterly variation from a true heading to calculate the magnetic heading.

CONFIRMATION OF TEACHING POINT 3

QUESTIONS:

- Q1. What is variation?
- Q2. What are isogonic lines?
- Q3. How is a magnetic heading calculated?

ANTICIPATED ANSWERS:

- A1. The angle between true north and magnetic north.
- A2. Isogonic lines join places of equal magnetic variation.
- A3. By adding westerly variation (subtracting easterly variation) to (from) the true heading.

Teaching Point 4

Describe compass errors.

Time: 10 min

Method: Interactive Lecture

Deviation

The magnetic compass is affected by anything metal that is in close proximity to it. When mounted in an aircraft, it is affected by the surrounding metal in the aircraft's frame and engine, as well as electrical equipment. The compass does not point to magnetic north, but is deflected slightly by the magnetic fields associated with the surrounding metal. The direction that the magnetic needle will point when affected by the running engine and working electrical equipment is unique to the aircraft. It is referred to as compass north. The angle between magnetic north and compass north is deviation.



Demonstrate deviation by placing a compass near a laptop computer or other electrical device.

Since deviation cannot be eliminated, the amount of deviation on a given heading is determined so that a pilot can compensate for this compass error. This occurs by swinging the compass. The aircraft is lined up on a

known magnetic heading with its engine running and all electrical equipment working. The direction is read from the compass and compared to the known magnetic heading. After this is taken on many headings, a compass correction card is prepared and placed in the aircraft.



Show the slide of Figure A-4 to the cadets.



Deviation must be added to or subtracted from the magnetic heading to calculate the compass heading.

When the magnetic heading is between the headings listed on the compass correction card, interpolate (estimate) the amount of deviation by using the two nearest magnetic headings that are listed.

Magnetic Dip

The magnetic lines of force of the Earth's magnetic field are horizontal at the equator, but bend down into the poles. This causes the north-seeking end of the needle to dip towards the ground. This error is more pronounced the closer the compass is to the poles.

Magnetic dip can be reduced, but not eliminated, by the design of the compass.

Northerly Turning Error

During a turn, centripetal and centrifugal forces combine with the inertial influence of the liquid in the compass bowl to affect the movement of the compass needle. This error is most apparent on north and south headings. The amount of the error is greatest over the poles and the least over the equator.



On turns from north, northerly turning error causes the compass to lag.

On turns from south, northerly turning error causes the compass to lead.

Acceleration and Deceleration Errors

Acceleration or deceleration of the aircraft affects the magnetic compass and the inertia causes a turning moment when the aircraft is on an east or west heading. Once the airspeed has stabilized, the compass will again read correctly.



Show the slide of Figure A-5 to the cadets.



On east and west headings:

- acceleration causes the compass to register a turn toward north, and
- deceleration causes the compass to register a turn toward south.

CONFIRMATION OF TEACHING POINT 4

QUESTIONS:

- Q1. For what does a compass card indicate corrections?
- Q2. What does a turn from the north cause a compass to do?
- Q3. On what headings do acceleration and deceleration cause the compass to register a turn?

ANTICIPATED ANSWERS:

- A1. Deviation.
- A2. Lag.
- A3. East and west.

END OF LESSON CONFIRMATION

The cadets' completion of the homework assignment will serve as the confirmation of this lesson.

CONCLUSION

HOMEWORK / READING / PRACTICE

Have the cadets complete the Magnetic Headings Worksheet located at Attachment B. Use the answer key located at Attachment C to review their answers.

METHOD OF EVALUATION

This EO is assessed IAW A-CR-CCP-804/PG-001, *Proficiency Level Four Qualification Standard and Plan*, Chapter 3, Annex B, Aviation Subjects–Combined Assessment PC.

CLOSING STATEMENT

To use a magnetic compass, the underlying principles must be understood. A compass is a common instrument in aviation and can act as a reference for setting other instruments. Magnetic compasses are useful not only in aviation but also on the ground and on the water.

INSTRUCTOR NOTES / REMARKS

Cadets who are qualified Advanced Aviation may assist with this instruction.

REFERENCES

C3-116 ISBN 0-9680390-5-7 MacDonald, A. F., & Peppler, I. L. (2000). *From the ground up: Millennium edition*. Ottawa, ON: Aviation Publishers Co. Limited.

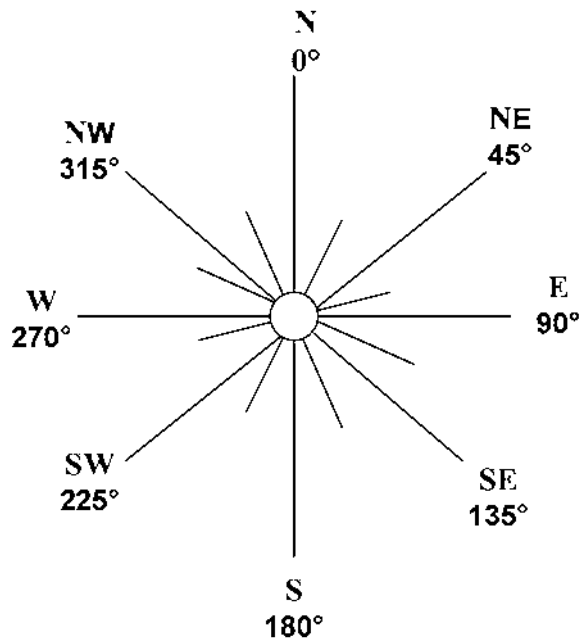

Figure A-1 Points on a Compass Rose

Note. Created by Director Cadets 3, 2007, Ottawa, ON: Department of National Defence.

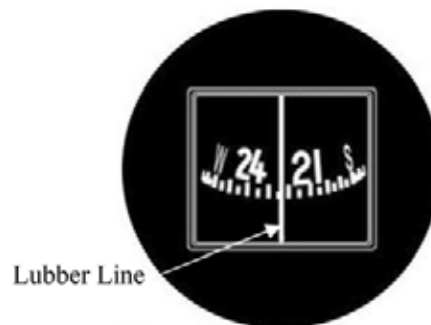

Figure A-2 Lubber Line

Note. From "Magnetic Compass", by North American Powered Parachute Federation, 2001, *Flight Instruments*, Copyright 2001 by North American Powered Parachute Federation. Retrieved November 8, 2007, from http://www.nappf.com/nappf_flight_instruments_files/image008.jpg

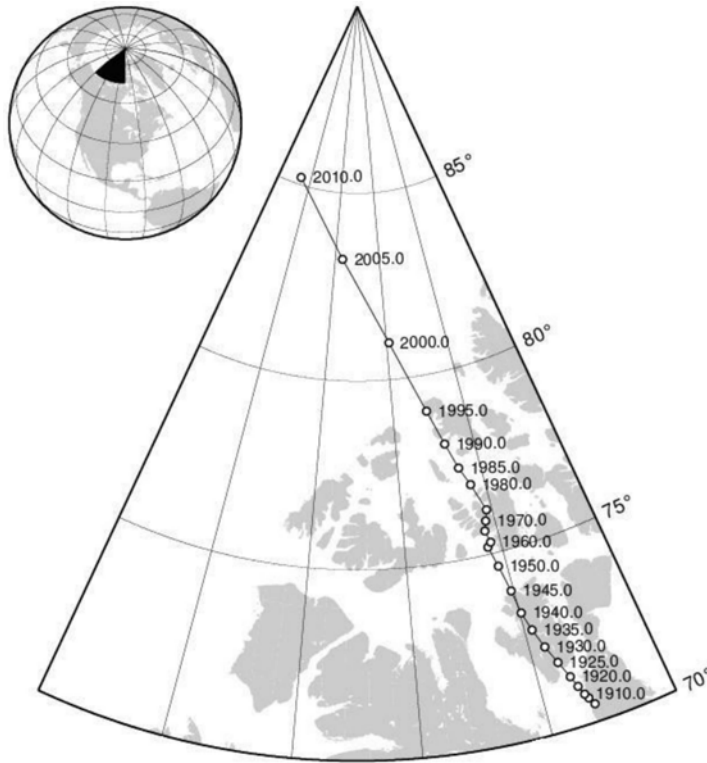

Figure A-3 Location of the Magnetic North Pole

Note. From "Locations of the North Magnetic Pole from IGRF-10", by K. Korhonen, *Helsinki University of Technology*. Retrieved November 8, 2007, from <http://users.tkk.fi/~kkorhon1/nmplocs.png>

For	0°	30°	60°	90°	120°	150°	180°	210°	240°	270°	300°	330°
Steer	359°	30°	60°	88°	120°	152°	183°	212°	240°	268°	300°	329°

Figure A-4 Compass Correction Card

Note. Created by Director Cadets 3, 2008, Ottawa, ON: Department of National Defence.

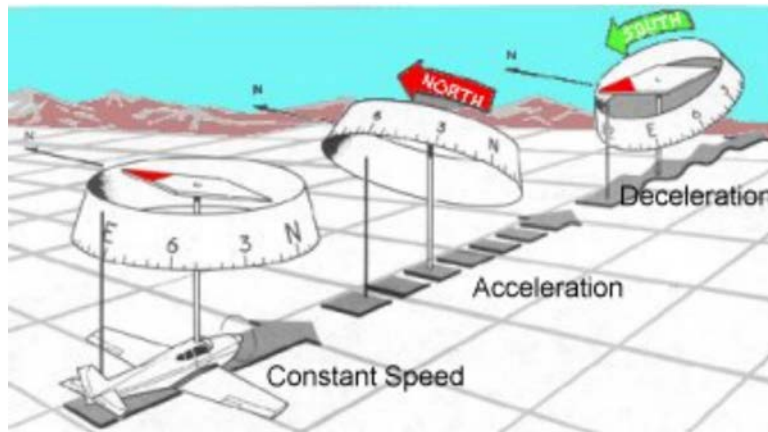

Figure A-5 Acceleration and Deceleration Errors

Note. From "Magnetism and the Magnetic Compass", by *Pilot's Web*. Retrieved November 8, 2007, from <http://pilotsweb.com/navigate/art/accel.jpg>

MAGNETIC HEADINGS WORKSHEET

Fill in the missing values.

	Variation	True Heading	Magnetic Heading
1.	8° west	120°	_____
2.	2° east	270°	_____
3.	11° east	010°	_____
4.	15° west	350°	_____
5.	22° east	180°	_____
6.	_____	090°	101°
7.	_____	085°	080°
8.	_____	359°	005°
9.	_____	254°	266°
10.	_____	122°	118°
11.	9° east	_____	113°
12.	3° west	_____	357°
13.	15° west	_____	345°
14.	12° east	_____	124°
15.	2° west	_____	180°

Sample Compass Correction Card

For	0°	30°	60°	90°	120°	150°	180°	210°	240°	270°	300°	330°
Steer	359°	30°	60°	88°	120°	152°	183°	212°	240°	268°	300°	329°

Fill in the missing values.

	Magnetic Heading	Compass Heading
1.	020°	_____
2.	161°	_____
3.	345°	_____
4.	_____	080°
5.	_____	215°

THIS PAGE INTENTIONALLY LEFT BLANK

MAGNETIC HEADINGS ANSWER KEY

Fill in the missing values.

	Variation	True Heading	Magnetic Heading
1.	8° west	120°	128°
2.	2° east	270°	268°
3.	11° east	010°	359°
4.	15° west	350°	005°
5.	22° east	180°	158°
6.	11° west	090°	101°
7.	5° east	085°	080°
8.	6° west	359°	005°
9.	12° west	254°	266°
10.	4° east	122°	118°
11.	9° east	122°	113°
12.	3° west	354°	357°
13.	15° west	330°	345°
14.	12° east	136°	124°
15.	2° west	178°	180°

Sample Compass Correction Card

For	0°	30°	60°	90°	120°	150°	180°	210°	240°	270°	300°	330°
Steer	359°	30°	60°	88°	120°	152°	183°	212°	240°	268°	300°	329°

Fill in the missing values.

	Magnetic Heading	Compass Heading
1.	020°	020°
2.	161°	163°
3.	345°	344°
4.	082°	080°
5.	213°	215°

THIS PAGE INTENTIONALLY LEFT BLANK



ROYAL CANADIAN AIR CADETS
PROFICIENCY LEVEL FOUR
INSTRUCTIONAL GUIDE



SECTION 3

EO C437.01 – SOLVE NAVIGATION PROBLEMS WITH A MANUAL FLIGHT COMPUTER

Total Time:	60 min
-------------	--------

PREPARATION

PRE-LESSON INSTRUCTIONS

Resources needed for the delivery of this lesson are listed in the lesson specification located in A-CR-CCP-804/PG-001, *Proficiency Level Four Qualification Standard and Plan*, Chapter 4. Specific uses for said resources are identified throughout the instructional guide within the TP for which they are required.

Review the lesson content and become familiar with the material prior to delivering the lesson.

Prepare slides of the figures located at Attachment A.

Photocopy the Navigation Problems Worksheet located at Attachment B for each cadet.

Assistant instructors may be required for this lesson.

PRE-LESSON ASSIGNMENT

Nil.

APPROACH

A demonstration and performance was chosen for this lesson as it allows the instructor to explain and demonstrate solving navigation problems with a manual flight computer while providing an opportunity for the cadets to practice this skill under supervision.

INTRODUCTION

REVIEW

Nil.

OBJECTIVES

By the end of this lesson the cadet shall have solved navigation problems with a manual flight computer.

IMPORTANCE

It is important for cadets to be able to solve navigation problems with a manual flight computer as it is an important skill that is required for flight planning and en route navigation. Solving navigation problems provides skills for potential instructional duties and is part of the fundamentals that cadets pursuing future aviation training will require.



For this lesson, it is recommended that the instruction take the following format:

1. Explain and demonstrate the technique to use the manual flight computer while the cadets observe.
2. Explain and demonstrate each step required to complete the skill. Monitor cadets as they imitate each step.
3. Monitor the cadets' performance as they practice using the manual flight computer to solve navigation problems.

Note: Assistant instructors may be used to monitor the cadets' performance.

Teaching Point 1

Demonstrate how to use a manual flight computer to convert units of measure and have the cadets practice converting units of measure.

Time: 25 min

Method: Demonstration and Performance

MANUAL FLIGHT COMPUTER

Navigation calculations are simplified by the use of a flight computer. Most manual flight computers consist of two sides: a circular slide rule and a wind side.



Show the slide of Figure A-1 to the cadets.



The instructions for using a manual flight computer are often printed directly on the flight computer.

Circular Slide Rule

The circular slide rule can be used to solve any problem of multiplication, division, or proportion. There are three scales printed on the circular slide rule. The outer scale is fixed to the computer. The two inner scales are printed together on a disc that may be rotated to any position opposite the outer scale.



Show the slide of Figure A-2 to the cadets.

The outer scale represents miles, gallons, true airspeed and corrected altitude. The inner scale represents time in minutes, calibrated airspeed, and calibrated altitude. The third scale represents time in hours and minutes.

The figures on the circular slide rule may represent any proportion or multiple of 10. For example, 10 on the outer scale may represent 1, 10, or 100; 45 may represent 4.5, 45, or 450.

CONVERTING UNITS OF MEASURE

One of the most common types of calculations a pilot has to make is converting from one unit of measure to another. Fuel is sold by the litre, but fuel quantities and consumption are usually specified in the aircraft manual in gallons. Wind speeds are reported in knots, but the airspeed indicator (ASI) may be in statute miles per hour.

Using the circular slide rule for conversion calculations is a simple process. Rotate the inner scale to the correct position, locate the original quantity / measure on the outer scale, and read the converted quantity / measure from the inner scale, opposite to the appropriate marking.

Convert Between Nautical and Statute Miles

To convert between nautical and statute miles:

1. Rotate the inner scale until the known number of miles is under the appropriate index (NAUT or STAT).
2. Read the converted number of miles under the other index.



For example, to convert 90 nautical miles to statute miles:

1. Rotate the inner scale until 90 is under the nautical miles index.
2. Read the number of statute miles under the statute miles index (104 statute miles).

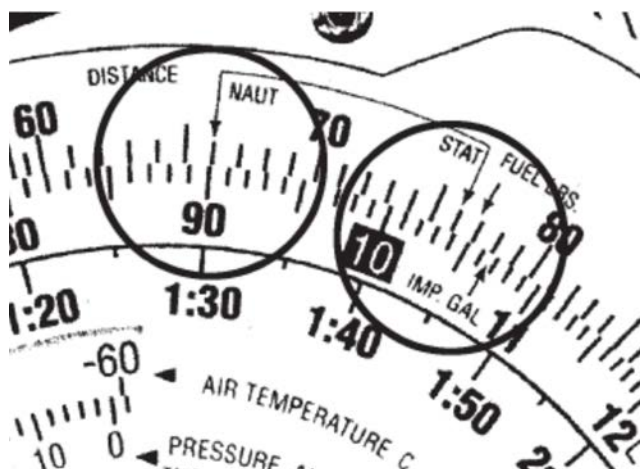



Figure 1 Nautical and Statute Mile Indexes

Note. From "Air Classics E6-B Flight Computer Instructions", *Aviation Supplies and Academics, Inc.* Retrieved November 26, 2008, from http://www.asa2fly.com/files/support/E6B_Manual.pdf

Convert Between Miles and Kilometres

To convert between miles and kilometres:

1. Rotate the inner scale until the known number is under the appropriate index (NAUT, STAT, or KM).
2. Read the converted number under the desired index.



For example, to convert 115 statute miles to kilometres:

1. Rotate the inner scale until 115 is under the statute miles index.
2. Read the number of kilometres under the kilometres index (185 km).



Figure 2 Statute Mile and Kilometre Indexes

Note. From "Air Classics E6-B Flight Computer Instructions", *Aviation Supplies and Academics, Inc.* Retrieved November 26, 2008, from http://www.asa2fly.com/files/support/E6B_Manual.pdf

Convert Between Imperial and US Gallons

To convert between imperial and US gallons:

1. Rotate the inner scale until the imperial and US gallon indexes are aligned.
2. Locate the known quantity (outer scale for imperial gallons and inner scale for US gallons) and read the desired quantity on the opposite scale.



For example, to convert 55 imperial gallons to US gallons:

1. Rotate the inner scale until the imperial and US gallon indexes are aligned.
2. Locate 55 on the outer scale and read the quantity of US gallons on the inner scale (66 US gallons).

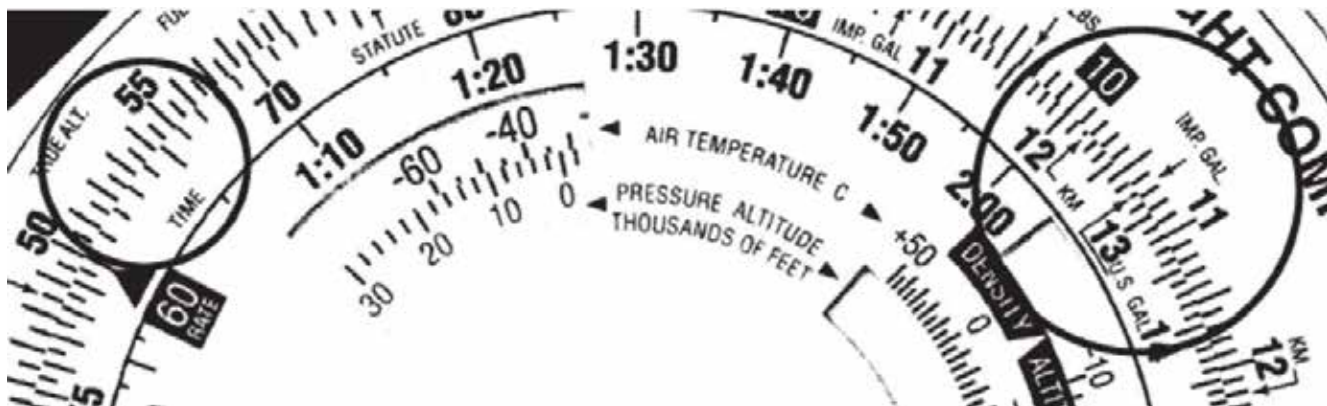

Figure 3 US and Imperial Gallon Indexes

Note. From "Air Classics E6-B Flight Computer Instructions", *Aviation Supplies and Academics, Inc.* Retrieved November 26, 2008, from http://www.asa2fly.com/files/support/E6B_Manual.pdf

Convert Between Gallons and Litres

To convert between gallons and litres:

1. Rotate the inner scale until the litres index is aligned with the appropriate gallon index.
2. Locate the known quantity and read the desired quantity on the opposite scale.



For example, to convert 100 L to US gallons:

1. Rotate the inner scale until the litres index is aligned with the US gallon index.
2. Locate 100 on the outer scale and read the quantity of US gallons on the inner scale (26 US gallons).

Convert Between Pounds and Kilograms

To convert between pounds and kilograms:

1. Rotate the inner scale until the pounds index is aligned with the kilograms index.
2. Locate the known quantity and read the desired quantity on the opposite scale.



For example, to convert 100 pounds to kilograms:

1. Rotate the inner scale until the pounds index is aligned with the kilograms index.
2. Locate 100 on the outer scale and read the quantity of kilograms on the inner scale (45 kg).

ACTIVITY

Time: 10 min

OBJECTIVE

The objective of this activity is to have the cadets practice converting units of measure using a manual flight computer.

RESOURCES

- Pen / pencil,
- Manual flight computer,
- Navigation Problems Worksheet located at Attachment B, and
- Navigation Problems Answer Key located at Attachment C.

ACTIVITY LAYOUT

Nil.

ACTIVITY INSTRUCTIONS

1. Distribute a manual flight computer and a Navigation Problems Worksheet to each cadet.
2. Have the cadets complete Part 1 of the worksheet using the manual flight computer.
3. Review the answers using the answer key located at Attachment C.

SAFETY

Nil.

CONFIRMATION OF TEACHING POINT 1

The cadets' participation in the activity will serve as the confirmation of this TP.

Teaching Point 2

Demonstrate how to use a manual flight computer to calculate speed, distance, and time and have the cadets practice calculating speed, distance, and time.

Time: 25 min

Method: Demonstration and Performance

SPEED, DISTANCE, AND TIME PROBLEMS

The rate arrow on the disk is always set to indicate a value per hour on the outer scale. There are three basic types of speed-time-distance problems. In two types of problems the speed is known, in the third, the speed is the unknown.



When solving speed, distance, and time problems, the units have to agree. For example, if the speed is in knots, the distance has to be in nautical miles and the time in hours.

If the units do not agree, use the circular slide rule to perform the required conversions to make the units agree before attempting to solve the problem.

Calculating Time (Speed and Distance are Known)

To calculate time when speed and distance are known:

1. Rotate the inner scale until the rate arrow is opposite the speed.
2. Locate the distance on the outer scale.
3. Read the time from the inner scale, opposite the distance.



For example, to calculate the time en route if the speed is 150 knots and the distance is 245 nautical miles:

1. Rotate the inner scale until the rate arrow is opposite 150.
2. Locate 245 on the outer scale.
3. Read the time en route from the inner scale, opposite 245 (1 hour and 38 minutes).

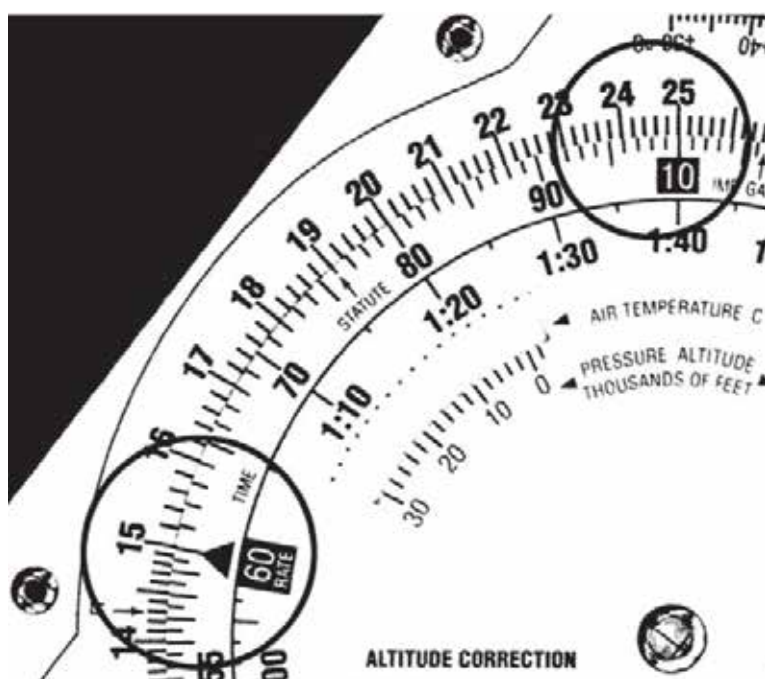

Figure 4 Rate Arrow, Speed, Distance, and Time

Note. From "Air Classics E6-B Flight Computer Instructions", *Aviation Supplies and Academics, Inc.* Retrieved November 26, 2008, from http://www.asa2fly.com/files/support/E6B_Manual.pdf



For example, to calculate the time en route if the speed is 120 knots and the distance is 100 statute miles:

1. Convert the distance to nautical miles (87).
2. Rotate the inner scale until the rate arrow is opposite 120.
3. Locate 87 on the outer scale.
4. Read the time en route from the inner scale, opposite 87 (44 minutes).



When calculating time en route, use the aircraft's groundspeed, not the airspeed.

Calculating Distance (Speed and Time are Known)

To calculate distance when speed and time are known:

1. Rotate the inner scale until the rate arrow is opposite the speed.
2. Locate the time on the inner scale.
3. Read the distance from the outer scale, opposite the time.



For example, to calculate the distance if the speed is 125 knots and the time en route is 4.5 hours:

1. Rotate the inner scale until the rate arrow is opposite 125.
2. Locate 4:30 on the inner scale.
3. Read the distance from the outer scale, opposite 4:30 (564 nautical miles).

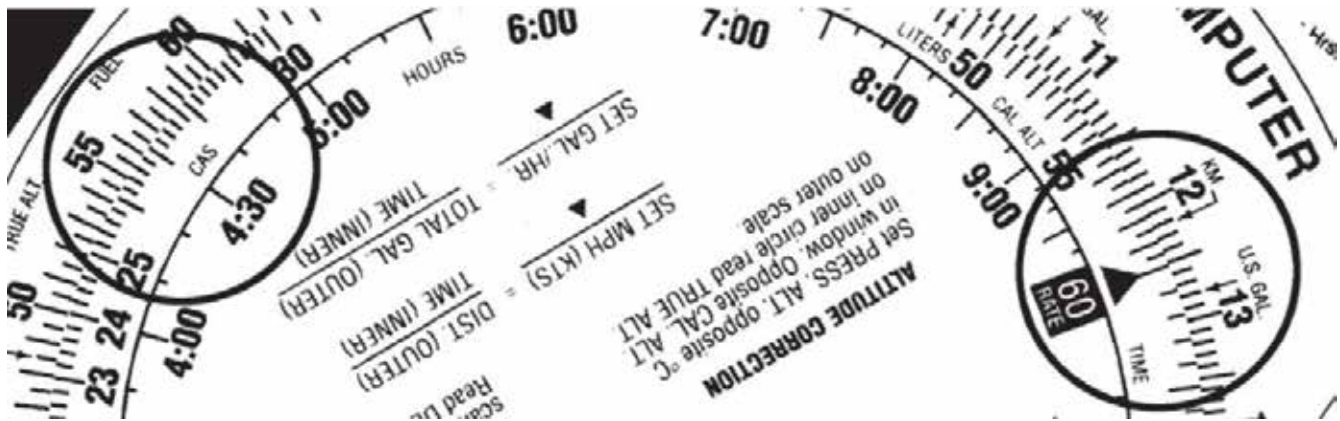

Figure 5 Rate Arrow, Speed, Distance, and Time

Note. From "Air Classics E6-B Flight Computer Instructions", *Aviation Supplies and Academics, Inc.* Retrieved November 26, 2008, from http://www.asa2fly.com/files/support/E6B_Manual.pdf



When calculating distance, use the aircraft's groundspeed, not the airspeed.

Calculating Speed (Distance and Time are Known)

To calculate speed when distance and time are known:

1. Rotate the inner scale until the distance is opposite the time.
2. Locate the rate arrow.
3. Read the speed from the outer scale, opposite the rate arrow.



For example, to calculate the speed if the distance is 26 nautical miles and the time en route is 13 minutes:

1. Rotate the inner scale until 26 is opposite 13.
2. Locate the rate arrow.
3. Read the speed from the outer scale, opposite the rate arrow (120 knots).

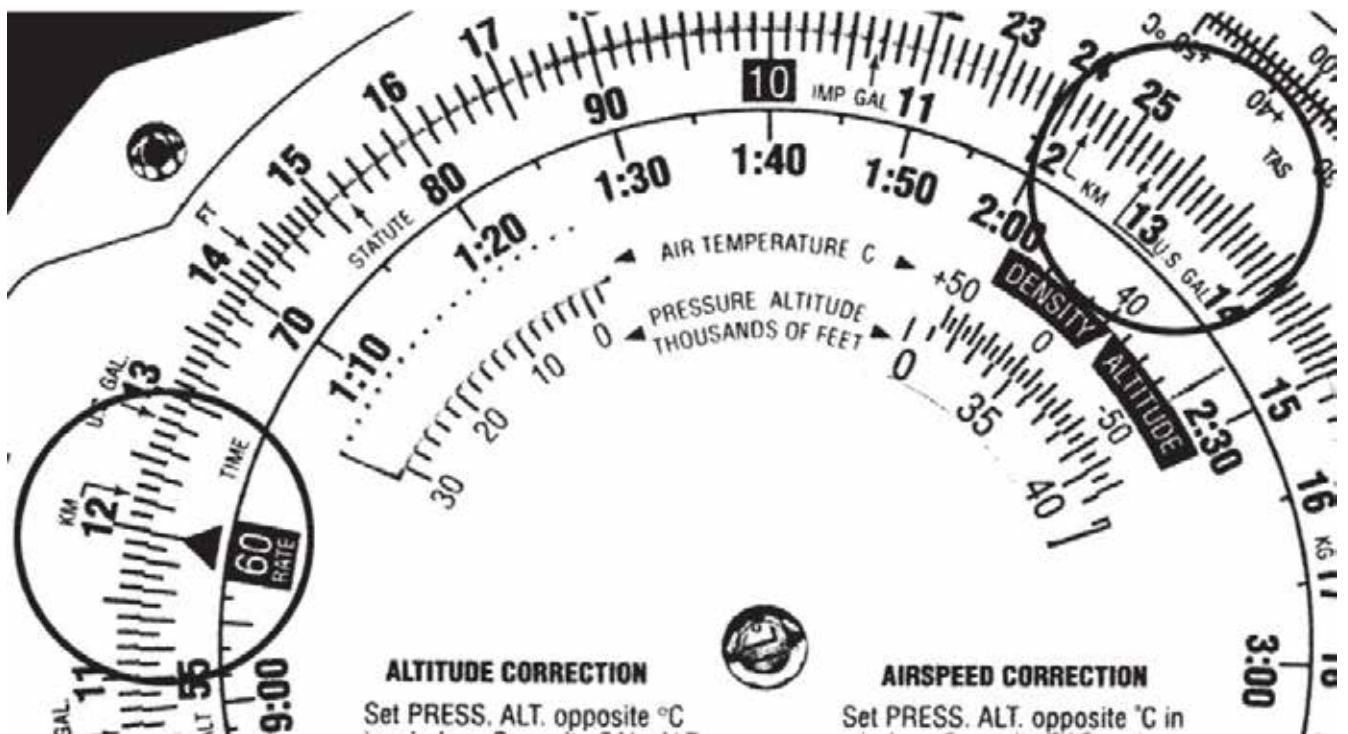

Figure 6 Rate Arrow, Speed, Distance, and Time

Note. From "Air Classics E6-B Flight Computer Instructions", *Aviation Supplies and Academics, Inc.* Retrieved November 26, 2008, from http://www.asa2fly.com/files/support/E6B_Manual.pdf



When calculating speed from distance and time, it is the groundspeed that is being calculated, not the airspeed.

ACTIVITY

Time: 10 min

OBJECTIVE

The objective of this activity is to have the cadets practice calculating speed, distance, and time using a manual flight computer.

RESOURCES

- Pen / pencil,
- Manual flight computer,

- Navigation Problems Worksheet located at Attachment B, and
- Navigation Problems Answer Key located at Attachment C.

ACTIVITY LAYOUT

Nil.

ACTIVITY INSTRUCTIONS

1. Have the cadets complete Part 2 of the worksheet using the manual flight computer.
2. Review the answers using the answer key located at Attachment C.

SAFETY

Nil.

CONFIRMATION OF TEACHING POINT 2

The cadets' participation in the activity will serve as the confirmation of this TP.

END OF LESSON CONFIRMATION

The cadets' completion of the Navigation Problems Worksheet will serve as the confirmation of this lesson.

CONCLUSION

HOMEWORK / READING / PRACTICE

Additional time may be required for the cadets to complete the worksheet.

METHOD OF EVALUATION

Nil.

CLOSING STATEMENT

Flight planning and navigation relies on being able to solve navigation problems. Being able to use a manual flight computer makes solving navigation problems faster and easier.

INSTRUCTOR NOTES / REMARKS

Assistant instructors may be required for this lesson.

Cadets who are qualified Advanced Aviation may assist with this instruction.

REFERENCES

C3-116 ISBN 0-9680390-5-7 MacDonald, A. F., & Pepler, I. L. (2000). *From the ground up: Millennium edition*. Ottawa, ON: Aviation Publishers Co. Limited.

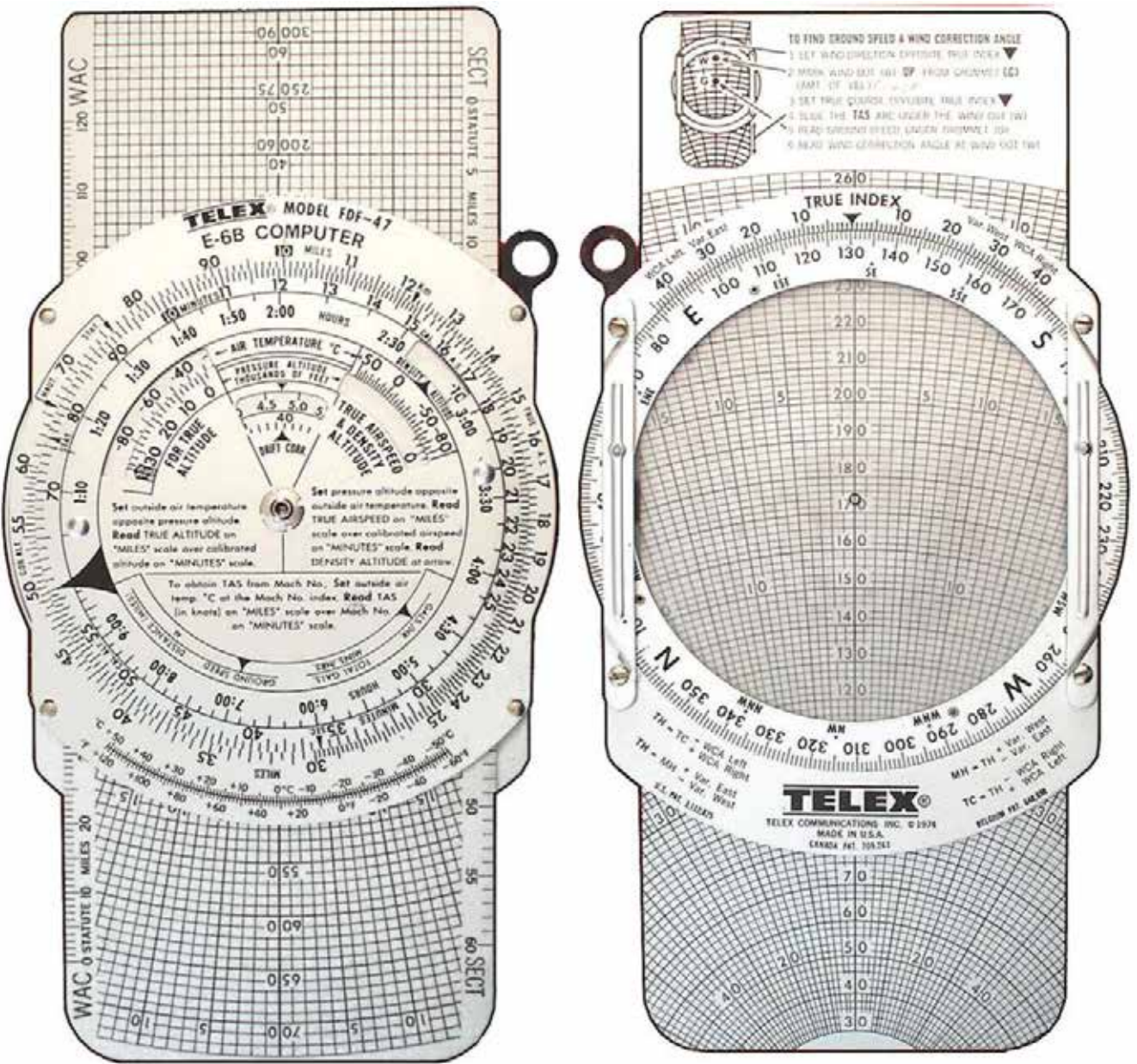

Figure A-1 E6B Manual Flight Computer

Note. From "Slide Rule Catalog", *Dutch Circle of Slide Rule Collectors*. Retrieved November 26, 2008, from <http://www.rekeninstrumenten.nl/pages%20and%20pictures/25261.jpg>

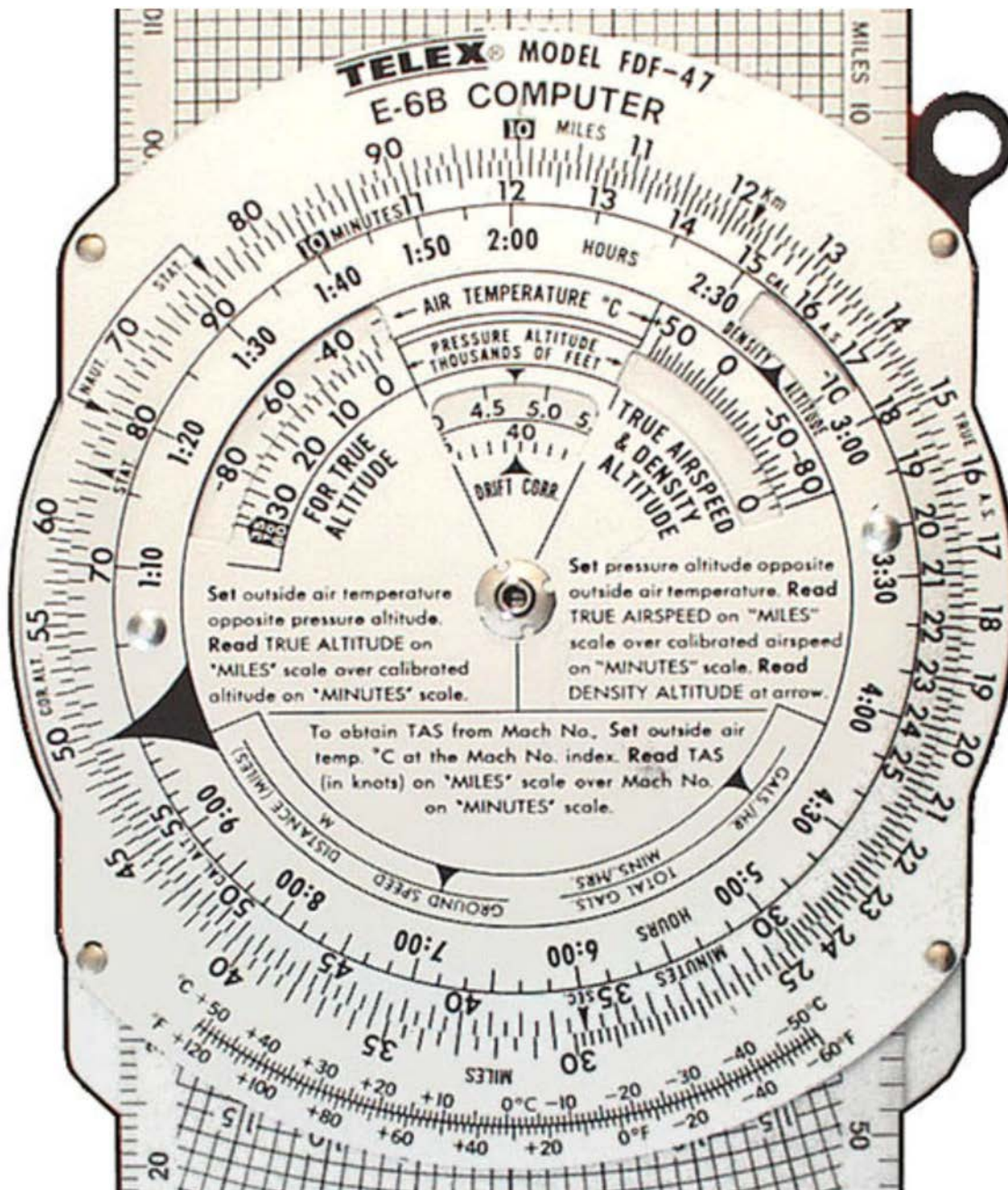

Figure A-2 E6B Circular Slide Rule

Note. From "Slide Rule Catalog", *Dutch Circle of Slide Rule Collectors*. Retrieved November 26, 2008, from <http://www.rekeninstrumenten.nl/pages%20and%20pictures/25261.jpg>

Navigation Problems Worksheet

Part 1

Convert	To	Convert	To
123 nautical miles	_____ statute miles	23 nautical miles	_____ statute miles
99 statute miles	_____ nautical miles	1000 statute miles	_____ nautical miles
400 statute miles	_____ km	85 statute miles	_____ km
25 km	_____ statute miles	110 km	_____ statute miles
156 km	_____ nautical miles	93 km	_____ nautical miles
225 nautical miles	_____ km	48 nautical miles	_____ km
10 US gallons	_____ gallons	150 US gallons	_____ gallons
150 US gallons	_____ L	35 US gallons	_____ L
35 gallons	_____ US gallons	10 gallons	_____ US gallons
48 gallons	_____ L	225 gallons	_____ L
93 L	_____ gallons	156 L	_____ gallons
110 L	_____ US gallons	25 L	_____ US gallons
55 pounds	_____ kg	400 pounds	_____ kg
85 kg	_____ pounds	99 kg	_____ pounds
1000 feet	_____ m	123 feet	_____ m
23 m	_____ feet	55 m	_____ feet

Part 2

Calculate the missing values.		
Speed	Distance	Time
130 knots	100 nautical miles	_____
85 knots	_____	2.5 hours
_____	250 nautical miles	4 hours 15 minutes
_____	25 nautical miles	5 minutes
65 knots	200 statute miles	_____
78 miles per hour	55 nautical miles	_____
330 km/h	300 km	_____
95 km/h	45 nautical miles	_____
_____	1000 km	320 minutes
_____	55 nautical miles	2 minutes
122 miles per hour	_____	1.3 hours
101 knots	_____	45 minutes
150 knots	5525 m	_____

THIS PAGE INTENTIONALLY LEFT BLANK

Navigation Problems Answer Key

Part 1

Convert	To	Convert	To
123 nautical miles	<u>142</u> statute miles	23 nautical miles	<u>26</u> statute miles
99 statute miles	<u>86</u> nautical miles	1000 statute miles	<u>869</u> nautical miles
400 statute miles	<u>644</u> km	85 statute miles	<u>137</u> km
25 km	<u>16</u> statute miles	110 km	<u>68</u> statute miles
156 km	<u>84</u> nautical miles	93 km	<u>50</u> nautical miles
225 nautical miles	<u>417</u> km	48 nautical miles	<u>89</u> km
10 US gallons	<u>8</u> gallons	150 US gallons	<u>125</u> gallons
150 US gallons	<u>568</u> L	35 US gallons	<u>132</u> L
35 gallons	<u>42</u> US gallons	10 gallons	<u>12</u> US gallons
48 gallons	<u>218</u> L	225 gallons	<u>1023</u> L
93 L	<u>20</u> gallons	156 L	<u>34</u> gallons
110 L	<u>29</u> US gallons	25 L	<u>7</u> US gallons
55 pounds	<u>25</u> kg	400 pounds	<u>181</u> kg
85 kg	<u>187</u> pounds	99 kg	<u>218</u> pounds
1000 feet	<u>305</u> m	123 feet	<u>37</u> m
23 m	<u>75</u> feet	55 m	<u>180</u> feet

Part 2

Calculate the missing values.		
Speed	Distance	Time
130 knots	100 nautical miles	46 minutes
85 knots	213 nautical miles	2.5 hours
59 knots	250 nautical miles	4 hours 15 minutes
300 knots	25 nautical miles	5 minutes
65 knots	200 statute miles	2 hours 41 minutes
78 miles per hour	55 nautical miles	48 minutes
330 km/h	300 km	55 minutes
95 km/h	45 nautical miles	52 minutes
188 km/h	1000 km	320 minutes
1650 knots	55 nautical miles	2 minutes
122 miles per hour	159 statute miles	1.3 hours
101 knots	76 nautical miles	45 minutes
150 knots	5525 m	1 minute

THIS PAGE INTENTIONALLY LEFT BLANK



**ROYAL CANADIAN AIR CADETS
PROFICIENCY LEVEL FOUR
INSTRUCTIONAL GUIDE**



SECTION 4

EO C437.02 – USE A VISUAL FLIGHT RULES (VFR) NAVIGATION CHART (VNC)

Total Time:	60 min
-------------	--------

PREPARATION

PRE-LESSON INSTRUCTIONS

Resources needed for the delivery of this lesson are listed in the lesson specification located in A-CR-CCP-804/PG-001, *Proficiency Level Four Qualification Standard and Plan*, Chapter 4. Specific uses for said resources are identified throughout the instructional guide within the TP for which they are required.

Review the lesson content and become familiar with the material prior to delivering the lesson.

Select coordinates of landmarks on a local VNC.

PRE-LESSON ASSIGNMENT

Nil.

APPROACH

An interactive lecture was chosen for TPs 1 and 2 to clarify, emphasize, and summarize types of projections and aeronautical charts.

A demonstration and performance was chosen for TPs 3–6 as it allows the instructor to explain and demonstrate using a VNC while providing an opportunity for the cadets to practice using a VNC under supervision.

INTRODUCTION

REVIEW

Nil.

OBJECTIVES

By the end of this lesson the cadet shall have used a VNC.

IMPORTANCE

It is important for cadets to use a VNC as it is a skill required for flight planning and en route navigation. The VNC is the principal chart used in flight at low altitudes and slow speeds. Many of the skills used with this chart are transferable to other types of maps both in the air and on the ground. Knowledge of this material is essential for future aviation training and potential instructional duties at the squadron.

Teaching Point 1**Explain types of projections.**

Time: 5 min

Method: Interactive Lecture

Earth is a sphere, so its surface cannot be represented accurately on a flat plane. Therefore, a map shows a portion of the Earth's surface with some distortion. There are four basic elements in map construction:

- areas,
- shapes,
- bearings, and
- distances.

Depending on the particular purpose of the map, one or more of these elements is preserved with minimal distortion, with the most distortion in the remaining elements.



Using the globe and the sheet of construction paper, demonstrate the impossibility of wrapping the sheet around the globe smoothly to create a chart.

The two principal types of chart projections used in air navigation charts are:

- the Lambert Conformal Conic Projection, and
- the Transverse Mercator Projection.

THE LAMBERT CONFORMAL CONIC PROJECTION

Using the globe and the sheet of construction paper, demonstrate superimposing a cone over the surface of the globe.

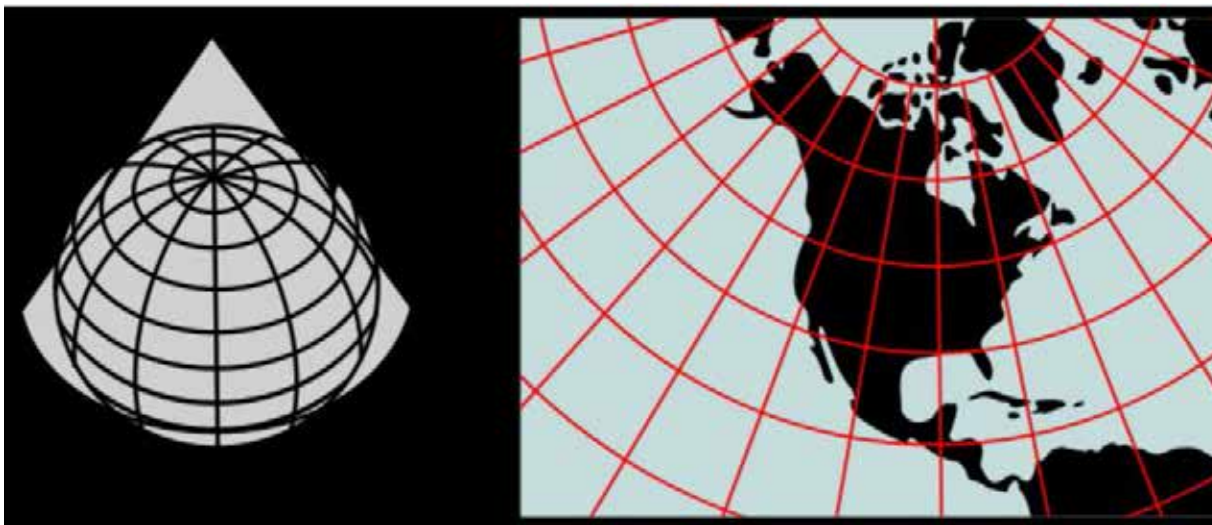

Figure 1 Lambert Conformal Conic Projection

Note. From "Image: Lambert Conformal Conic", *Wikimedia*. Retrieved November 27, 2008, from http://commons.wikimedia.org/wiki/Image:Lambert_conformal_conic.svg

The properties of the Lambert Conformal Conic Projection are:

- Meridians of longitude are slight curves or straight lines converging toward the nearer pole.
- Parallels of latitude are curves which are concave toward the nearer pole.
- The scale of distance is uniform throughout the entire chart.
- A straight line drawn between any two points on the chart represents an arc of a great circle.

VNCs and World Aeronautical Charts (WACs) are examples of Lambert Conformal Conic Projections.

The Transverse Mercator Projection. Applies the Mercator technique by rotating the cylinder 90 degrees so the point of tangency is a meridian of longitude rather than the equator. This projection is accurate in depicting scale, especially on charts covering a relatively small geographical area. The VFR Terminal Area (VTA) Charts are examples of Transverse Mercator Projections.



Using the globe and the sheet of flip chart paper, demonstrate wrapping a cylinder around the globe with its point of tangency at a meridian of longitude.

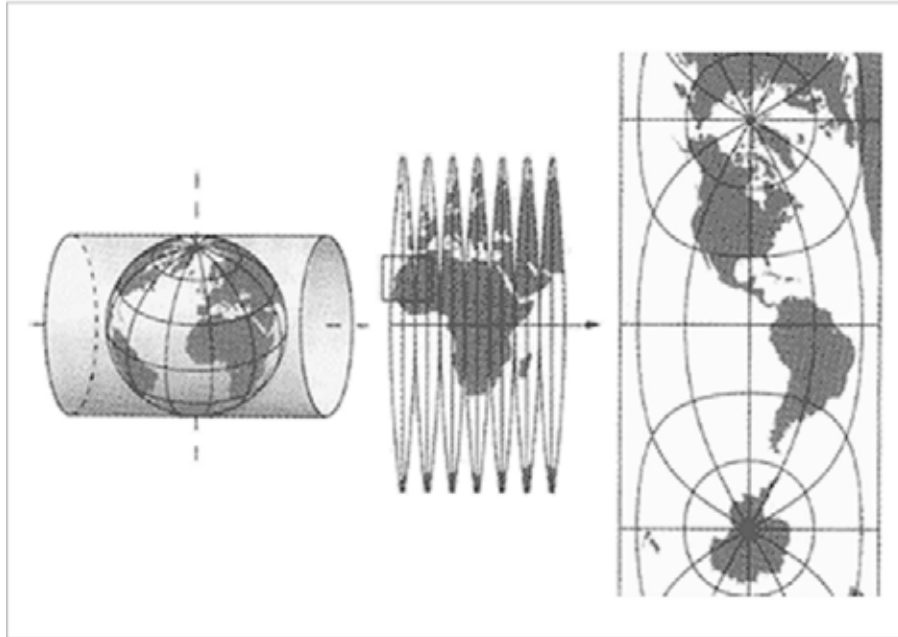

Figure 2 Transverse Mercator Projection

Note. From "Swiss Map Projections", 2008, *Federal Office of Topography Swisstopo*. Retrieved November 27, 2008, from <http://www.swisstopo.admin.ch/internet/swisstopo/en/home/topics/survey/sys/refsys/projections.html>

CONFIRMATION OF TEACHING POINT 1

QUESTIONS:

- Q1. What does a straight line drawn between any two points on a Lambert Conformal Conic Projection represent?
- Q2. What are two examples of Lambert Conformal Conic Projections?
- Q3. What is an example of a Transverse Mercator Projection?

ANTICIPATED ANSWERS:

- A1. An arc of a great circle.
- A2. VNCs and WACs.
- A3. A VTA Chart is an example of a Transverse Mercator Projection.

Teaching Point 2**Describe types of aeronautical charts.**

Time: 5 min

Method: Interactive Lecture

VFR NAVIGATION CHART (VNC)

Show the cadets a VNC.

VNCs are designed primarily for visual navigation at low altitudes and slow speeds. Each chart is identified by the name of a principal landmark on the chart (eg, Toronto, Winnipeg, Gander). The scale of the chart is 1 : 500 000 or about one inch to eight miles.

WORLD AERONAUTICAL CHART (WAC)

Show the cadets a WAC.

WACs are designed primarily for visual navigation at higher altitudes and greater speeds. Each chart depicts a sizeable portion of the country's geographical area—eighteen charts cover Canada. Each chart is identified by a letter and a number. For example, E17 covers the area from Marathon, Ont., west to Brandon, Man., and from the 48th parallel north to Thompson, Man. The scale of the chart is 1 : 1 000 000 or about one inch to 16 miles.

VFR TERMINAL AREA (VTA) CHART

Show the cadets a VTA Chart.

VTA Charts are large scale charts (1 : 250 000) published for airports where there is a high volume of air traffic and where there is usually a mix of controlled airspace. Radio communication information and other information that is necessary for conducting flight through the area are given on the chart.

ENROUTE CHART

Show the cadets an Enroute Chart.

Enroute Charts provide information for radio navigation over designated airways systems. Enroute Charts do not portray any cities, towns, or topographical features. They depict all radio navigation aids, including airways, beacons, reporting points, and communication frequencies. Examples of Enroute Charts are Enroute Low Altitude Charts, Enroute High Altitude Charts, and Terminal Area Charts.



Canada Flight Supplement (CFS). A joint civil / military flight information publication and a supplement of the Aeronautical Information Publication (AIP). It contains information on Canadian and North Atlantic aerodromes. The CFS is designed to be used in conjunction with all Canadian charts and should be carried by every pilot departing on a flight. It is revised and reissued every 56 days.

CONFIRMATION OF TEACHING POINT 2

QUESTIONS:

- Q1. What is the scale of a VNC?
- Q2. What are WACs primarily used for?
- Q3. What are Enroute Charts used for?

ANTICIPATED ANSWERS:

- A1. 1 : 500 000.
- A2. Visual navigation at higher altitudes and greater speeds.
- A3. Radio navigation.

Teaching Point 3

Explain, demonstrate and have the cadets practice locating landmarks on a VNC using latitude and longitude.

Time: 15 min

Method: Demonstration and Performance



For this TP, it is recommended that the instruction take the following format:

1. Explain and demonstrate the skill while the cadets observe.
2. Explain and demonstrate each step required to complete the skill. Monitor cadets as they imitate each step.
3. Monitor the cadets' performance as they practice the skill.

Note: Assistant instructors may be used to monitor the cadets' performance.

USE LATITUDE AND LONGITUDE TO LOCATE LANDMARKS ON A VNC



The cadets were introduced to latitude and longitude in EO M437.01 (Define Air Navigation Terms). They were asked to find the coordinates of a major airport. In this TP, the cadets are given the coordinates and asked to find the landmarks. They should require minimal instruction as it is a review.



Give the cadets coordinates of several landmarks on a local VNC and have them identify the landmarks.

For example, 43°59'N, 80°17'W is a soaring site (Grand Valley).



Figure 3 Example of a VNC

Note. From *Toronto VFR Navigation Chart*, by Geomatics Canada, 2001, Ottawa, ON: Geomatics Canada Department of Natural Resources. Copyright 2001 by NAV CANADA and Her Majesty the Queen in Right of Canada.

CONFIRMATION OF TEACHING POINT 3

The cadets' participation in locating landmarks on a VNC using latitude and longitude will serve as the confirmation of this TP.

Teaching Point 4

Explain, demonstrate and have the cadets practice plotting tracks between landmarks on a VNC.

Time: 5 min

Method: Demonstration and Performance



For this TP, it is recommended that the instruction take the following format:

1. Explain and demonstrate the skill while the cadets observe.
2. Explain and demonstrate each step required to complete the skill. Monitor cadets as they imitate each step.
3. Monitor the cadets' performance as they practice the skill.

Note: Assistant instructors may be used to monitor the cadets' performance.

PLOT A TRACK BETWEEN LANDMARKS ON A VNC

To plot a track between landmarks on a VNC:

1. Identify the landmarks.
2. Use a ruler to draw a straight line between the landmarks.



Give the cadets coordinates of a departure aerodrome and a destination aerodrome on a local VNC. Have them plot a track.



More advanced flight plan plotting (eg, 10-degree drift lines) will be taught during future aviation training.

CONFIRMATION OF TEACHING POINT 4

The cadets' participation in plotting tracks between landmarks on a VNC will serve as the confirmation of this TP.

Teaching Point 5

Explain, demonstrate and have the cadets practice measuring distances on a VNC.

Time: 10 min

Method: Demonstration and Performance



For this TP, it is recommended that the instruction take the following format:

1. Explain and demonstrate the skill while the cadets observe.
2. Explain and demonstrate each step required to complete the skill. Monitor cadets as they imitate each step.
3. Monitor the cadets' performance as they practice the skill.

Note: Assistant instructors may be used to monitor the cadets' performance.

MEASURE DISTANCE ON A VNC

Measure distance on a VNC by:

- using a scale, or
- using an International Civil Aviation Organization (ICAO) ruler.

Using a Scale

The scale of the chart is the relationship between a unit of distance (eg, one inch) on the chart to the distance that the unit represents on the surface of the Earth.

There are two scales found on a VNC:

- **Representative fraction.** A ratio representing the distance on a map in relation to the surface of the Earth. The representative fraction of a VNC is 1 : 500 000 (one inch on the map represents 500 000 inches or eight miles).
- **Graduated scale line.** Three scale lines printed on the border of the chart representing kilometres, statute miles, and nautical miles. The distance between two locations on a VNC can be compared to one of these lines to give the represented distance in any of the three units of distance.

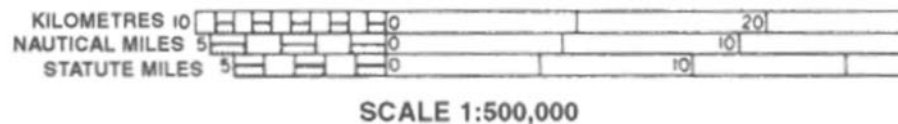

Figure 4 Graduated Scale Line

Note. From *From the Ground Up: Millennium Edition* (p. 123), by A. F. MacDonald and I. L. Peppler, 2000, Ottawa, ON: Aviation Publishers Co. Limited. Copyright 2000 by Aviation Publishers Co. Limited.

To measure distance on a VNC using the representative fraction:

1. Use a ruler to measure the distance between two landmarks in inches.
2. Multiply the number of inches by eight to determine the distance in statute miles.

To measure distance on a VNC using the graduated scale:

1. Use a straightedge to measure the distance between two landmarks.
2. Line the straightedge up with the graduated scale, starting at the zero mark, to determine the distance in kilometres, nautical miles, or statute miles.



Have the cadets practice measuring distance using each technique.

Using an ICAO Ruler

ICAO ruler. A plastic straightedge graduated in both statute and nautical miles for use with 1 : 1 000 000 and 1 : 500 000 scale charts. On its reverse side, the ICAO ruler provides conversion factors, VHF reception distances, standard time conversions to Co-ordinated Universal Time (UTC), time equivalencies, flight plan sequences, and an aviation gasoline conversion table.

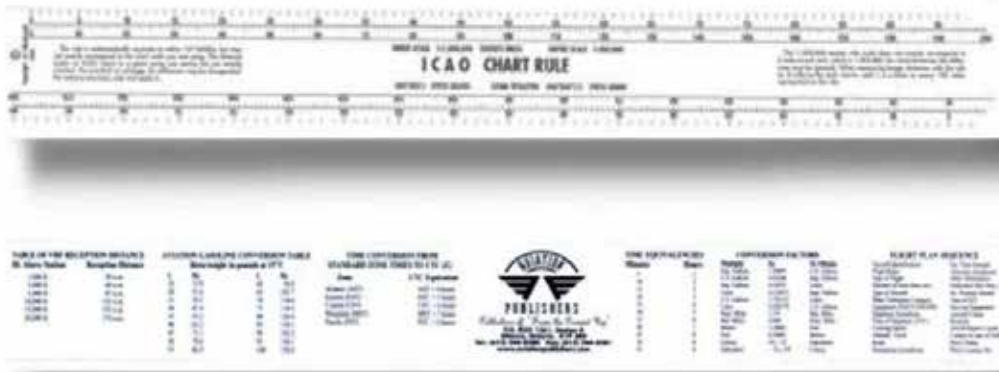

Figure 5 ICAO Ruler

Note. From "Other Publications", *Aviation Publishers*. Retrieved November 28, 2008, from <http://www.aviationpublishers.com/otherpub/icao.html>

To measure distance on a VNC using an ICAO ruler:

1. Align the edge of the ruler with the track. Ensure the zero mark is at one of the landmarks.
2. Read the desired scale (nautical miles or statute miles) where the ruler meets the other landmark.



Use the edge of the ICAO ruler meant for 1 : 500 000 scale charts.



Have the cadets practice measuring distance using this technique.

CONFIRMATION OF TEACHING POINT 5

The cadets' participation in measuring distances on a VNC will serve as the confirmation of this TP.

Teaching Point 6**Explain, demonstrate and have the cadets practice determining headings on a VNC.**

Time: 10 min

Method: Demonstration and Performance



For this TP, it is recommended that the instruction take the following format:

1. Explain and demonstrate the skill while the cadets observe.
2. Explain and demonstrate each step required to complete the skill. Monitor cadets as they imitate each step.
3. Monitor the cadets' performance as they practice the skill.

Note: Assistant instructors may be used to monitor the cadets' performance.

DETERMINE A HEADING ON A VNC

Douglas protractor. A tool used for determining headings and as a straightedge. It is transparent and has a compass rose graduated in 360 degrees marked around the outer edges.

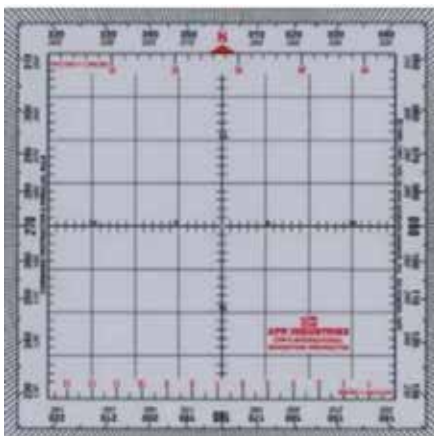

Figure 6 Douglas Protractor

Note. From "Douglas Protractor / Parallel Ruler", *VIP Pilot Centre*. Retrieved November 28, 2008, from <http://www.canada-shops.com/Magasin/vippilotcenter/c46907p95758.2.html>

To determine a heading on a VNC using a Douglas protractor:

1. Place the protractor on the chart with the hole in the centre lying on the track at a point where the north-south line on the protractor lies along the meridian of longitude. If this is not convenient, one of the vertical lines can be lined up parallel with the nearest meridian.
2. Read the heading where the track cuts the edge of the protractor.



Have the cadets determine the headings of the tracks previously plotted. Have them plot more tracks and determine the headings as time permits.

CONFIRMATION OF TEACHING POINT 6

The cadets' participation in determining headings on a VNC will serve as the confirmation of this TP.

END OF LESSON CONFIRMATION

The cadets' performance of locating landmarks, plotting tracks, measuring distances, and determining headings on a VNC will serve as the confirmation of this lesson.

CONCLUSION

HOMEWORK / READING / PRACTICE

Nil.

METHOD OF EVALUATION

Nil.

CLOSING STATEMENT

Flight planning and navigating at low altitudes and slow speeds relies on being able to use a VNC. Many of the skills used with this chart are transferable to other types of maps both in the air and on the ground.

INSTRUCTOR NOTES / REMARKS

Assistant instructors may be required for this lesson.

Cadets who are qualified Advanced Aviation may assist with this instruction.

REFERENCES

C3-116 ISBN 0-9680390-5-7 MacDonald, A. F., & Pepler, I. L. (2000). *From the ground up: Millennium edition*. Ottawa, ON: Aviation Publishers Co. Limited.



**ROYAL CANADIAN AIR CADETS
PROFICIENCY LEVEL FOUR
INSTRUCTIONAL GUIDE**



SECTION 1

EO M440.01 – IDENTIFY AEROSPACE MATERIALS

Total Time:	30 min
-------------	--------

PREPARATION

PRE-LESSON INSTRUCTIONS

Resources needed for the delivery of this lesson are listed in the lesson specification located in A-CR-CCP-804/PG-001, *Proficiency Level Four Qualification Standard and Plan*, Chapter 4. Specific uses for said resources are identified throughout the instructional guide within the TP for which they are required.

Review the lesson content and become familiar with the material prior to delivering the lesson.

Create slides of the figures located at Attachments A and B.

PRE-LESSON ASSIGNMENT

Nil.

APPROACH

An interactive lecture was chosen for this lesson to introduce aerospace materials and to generate interest in the subject.

INTRODUCTION

REVIEW

Nil.

OBJECTIVES

By the end of this lesson the cadet shall be expected to identify materials used in aerospace construction.

IMPORTANCE

It is important for cadets to learn about materials used in aerospace construction, as it will enhance their understanding of the materials used to build spacecraft and why they are chosen.

Teaching Point 1**Discuss metals used in aerospace construction.**

Time: 15 min

Method: Interactive Lecture

METALS USED IN AEROSPACE CONSTRUCTION

During this TP, pass around samples of small pieces of components made from aluminum, magnesium, titanium, and stainless steel.

Aluminum

Pure aluminum lacks sufficient strength to be used for aerospace construction. However, its strength increases considerably when it is alloyed, mixed with other compatible metals. For example, when aluminum is mixed with copper or zinc, the resultant aluminum alloy is as strong as steel, with only one-third the weight. As well, the considerable corrosion resistance possessed by the aluminum carries over to the newly formed alloy. Aluminum is the most commonly used metal for spacecraft structure.

Magnesium

Magnesium is one of the lightest metals with sufficient strength and suitable working characteristics for use in aerospace structures. That is, in its pure form it lacks sufficient strength but, like aluminum, mixing it with other metals to create an alloy produces strength characteristics that make magnesium useful.

Titanium

Titanium and its alloys are lightweight metals with very high strength. Pure titanium weighs only half as much as stainless steel and is soft and ductile. Titanium alloys have excellent corrosion resistance, particularly to salt water.

Stainless Steel

Stainless steel is a classification of corrosion-resistant steel that contains large amounts of chromium and nickel. It is well suited to high-temperature applications such as firewalls and exhaust system components.

MATERIAL TESTS

The study of materials used in aerospace construction is vast and growing rapidly as scientists and engineers gain experience using materials, both new and old, in frontier applications and environments. All materials represent opportunity, but they must be correctly used. Space includes a variety of environments, each with different challenges, such as the Low Earth Orbit (LEO) environment encountered by the International Space Station (ISS) and space shuttle missions. Materials are selected for use in applications after careful study in laboratories, including laboratories in orbit such as the Long Duration Exposure Facility (LDEF).

LDEF was deployed in orbit on April 7, 1984 by the Shuttle Challenger. The nearly circular orbit was at an altitude of 275 nautical miles. LDEF remained in space for about 5.7 years and completed 32,422 Earth orbits. It experienced one-half of a solar cycle, as it was deployed during a solar minimum and retrieved at a solar maximum. LDEF was retrieved on January 11, 1990 by the Shuttle Columbia. By the time LDEF was retrieved, its orbit had decayed to 175 nautical miles and was a little more than one month away from re-entering the atmosphere.



The Long Duration Exposure Facility (LDEF) Archive System, maintained by NASA Langley Research Center, is designed to provide spacecraft designers and space environment researchers with a single point access to all available resources from LDEF. It is found at <http://setas-www.larc.nasa.gov/LDEF/index.html>

ORBIT ENVIRONMENT

The characteristics of a spacecraft's orbit are determined by its mission. Some spacecraft travel between worlds and must be capable of functioning in a variety of conditions. Most spacecraft, however, are used in an application that restricts them to a narrow range of space environments. The relative impact of any of the space environments' effects on materials depends on the type of mission the spacecraft has to perform (eg, communications, defense, Earth observing) and, more important, the orbits in which the spacecraft is placed.



Show the cadets the slide of Figure A-1 located at Attachment A.

Figure A-1 shows the variations in the space environment as a function of orbit altitude. LEO extends up to 1000 km. Mid-Earth Orbit (MEO) is above 1000 km and extends up to 35 000 km. Geosynchronous orbit (GEO) is 35 000 km and higher.



Show the cadets the slide of Figures A-2 and A-3 located at Attachment A.

Major space environment hazards in LEO include atomic oxygen, ultraviolet radiation, frequent cycling between hot and cold temperatures, micrometeoroids, debris and contamination.



Atomic oxygen (AO) is an elemental form of oxygen that does not exist in the Earth's atmosphere. In space, however, it is common in the LEO area where satellites orbit the Earth. There, it reacts with other materials very easily and exposes satellites and spacecraft to damaging corrosion. Researchers at NASA's Glenn Research Center study these damaging effects in order to find materials and methods to extend the lifetime of communication satellites, the Space Shuttles and the ISS.



Show the cadets the slide of Figure A-4 located at Attachment A.

To prevent AO from damaging metal surfaces, protective coatings are applied to the metal's surface. AO flux and ultraviolet radiation interact in the degradation of silver and Teflon materials.



Cadets can explore Space Weather: Impact of the Orbital Environment on the MOST microsatellite mission at <http://www.astro.ubc.ca/MOST/posters/WS-Kristy-poster.jpg>

Orbital debris is another hazard for materials in LEO. This refers to man-made particles orbiting the Earth. Within about 2 000 km above Earth's surface there is an estimated 3 000 000 kg of man-made orbiting objects. These objects are in mostly high inclination orbits and sweep past one another at an average speed of 10 km / second. These particles are a result of standard launch and spacecraft operations as well as rocket and satellite breakups. Launch and spacecraft operations place both large particles (eg, greater than 1-cm diameter such as satellite shrouds, lens covers, and dropped tools) and small particles (eg, approximately 10-micron diameter solid rocket exhaust) in orbit.

Impacts can alter material states and expose underlying materials, allowing the space environments (eg, AO) to further increase the damage area and begin damaging previously unexposed areas. AO undercutting of polymer substrates under protective coatings is a phenomenon that can be a concern for space applications of multi-layer insulation.

CONFIRMATION OF TEACHING POINT 1

QUESTIONS:

- Q1. Why is pure aluminum unsuitable for use in many applications of aerospace construction?
- Q2. What three characteristics make titanium useful for aerospace components?
- Q3. What two metals are mixed with steel to make stainless steel?

ANTICIPATED ANSWERS:

- A1. Pure aluminum lacks sufficient strength for aerospace construction.
- A2. Titanium alloys have high strength, are lightweight and are resistant to corrosion.
- A3. Steel is mixed with chromium and nickel.

Teaching Point 2

Discuss composite materials used in aerospace construction.

Time: 10 min

Method: Interactive Lecture

COMPOSITE CONSTRUCTION



The term composite refers to a combination of two or more materials that differ in composition or form. Composite is sometimes used to mean any synthetic building material.

Composite structures differ from metallic structures in important ways: excellent elastic properties, high strength combined with light weight and the ability to be customized in strength and stiffness. The fundamental nature of many composites comes from the characteristics of a strong fibre cloth imbedded in a resin.



Pass around clearly marked samples of fibreglass cloth, aramid cloth and carbon fibre cloth.

Fibreglass

Fibreglass is made from strands of silica glass that are spun together and woven into cloth. Fibreglass weighs more and has less strength than most other composite fibres. However, improved matrix materials now allow fibreglass to be used in advanced composite aerospace applications.

There are different types of glass used in fibreglass: E-glass, which has a high resistance to electric current and S-glass, which has a higher tensile strength, meaning that the fabric made from it resists tearing.

Aramid

Aramid is a polymer. A polymer is composed of one or more large molecules that are formed from repeated units of smaller molecules.



Ask the cadets to name all the applications they are aware of for Kevlar®.

The best-known aramid material is Kevlar®, which has a tensile strength approximately four times greater than the best aluminum alloy. This cloth material is used in many applications where great strength is needed: canoes, body armour and helicopter rotors. Aramid is ideal for aerospace parts that are subject to high stress and vibration. The aramid's flexibility allows it to twist and bend in flight, absorbing much of the stress. In contrast, a metal part would develop fatigue and stress cracks sooner under the same conditions.

Carbon / Graphite

The term carbon is often used interchangeably with the term graphite; however, they are not quite the same material. Carbon fibres are formed at 1315 degrees Celsius (2400 degrees Fahrenheit), but graphite fibres are produced only above 1900 degrees Celsius (3450 degrees Fahrenheit). As well, their actual carbon content differs—but both carbon and graphite materials have high compressive strength and stiffness.

Carbon molecules will form long strings that are extremely tough (this is what makes diamonds so strong). These minute hair-like strands of carbon (a very common and inexpensive element) are, per unit of weight, many times stronger than steel. Individual carbon fibres are flexible, rather than stiff, and bend easily despite having high tensile strength. To stiffen the fibres, cross-directional layers are immersed in a matrix material such as epoxy plastic. A matrix is any material that sticks them together.



The term epoxy refers to a substance derived from an epoxide. An epoxide is a carbon compound containing an oxygen atom bonded in a triangular arrangement to two carbon atoms. So, an epoxy matrix is itself carbon-based, as are the fibres that it binds.

Ceramic

Ceramic fibre is a form of glass fibre designed for use in high temperature applications. It can withstand temperatures approaching 1650 degrees Celsius (3000 degrees Fahrenheit), making it effective for use around engines and exhaust systems.



Show the cadets the slide of Figure B-1 located at Attachment B.

Ceramic's disadvantages include both weight and expense, but sometimes no other known material will do the job. One of the most famous applications of ceramic is the Thermal Protection System (TPS) used on the space shuttle. The properties of aluminum demand that the maximum temperature of the shuttle's structure be kept below 175 degrees Celsius (350 degrees Fahrenheit) during operations. Heating during re-entry (in other words, heating caused by friction with the air) creates surface temperatures high above this level, and in many places will push the temperature well above the melting point of aluminum (660 degrees Celsius or 1220 degrees Fahrenheit).



Underneath its protective layer of tiles and other materials, the space shuttle has an ordinary aluminum construction, similar to many large aircraft.



Show the cadets the slide of Figure B-2 located at Attachment B.

A space shuttle's TPS is very complex and it contains highly sophisticated materials. Thousands of tiles of various sizes and shapes cover a large percentage of the space shuttle's exterior surface. There are two main types of silica ceramic tiles used on the space shuttle:

- **Low-Temperature Reusable Surface Insulation (LRSI).** LRSI tiles cover relatively low-temperature areas of one of the shuttles, the Columbia, where the maximum surface temperature runs between 370 and 650 degrees Celsius (700 and 1200 degrees Fahrenheit), primarily on the upper surface of fuselage around the cockpit. These tiles have a white ceramic coating that reflects solar radiation while in space, keeping the Columbia cool.



Show the cadets the slide of Figure B-3 located at Attachment B.

- **High-Temperature Reusable Surface Insulation (HRSI).** HRSI tiles cover areas where the maximum surface temperature runs between 650 and 1260 degrees Celsius (1200 and 2300 degrees Fahrenheit). They have a black ceramic coating, which helps them radiate heat during re-entry.

Both LRSI and HRSI tiles are manufactured from the same material and their primary difference is the coating.

A different and even more sophisticated material, Reinforced Carbon-Carbon (RCC), is used for the nose cone and leading edges of the space shuttle. It is a composite material consisting of carbon fibre reinforcement in a matrix of graphite, often with a silicon carbide coating to prevent oxidation.

CONFIRMATION OF TEACHING POINT 2**QUESTIONS:**

- Q1. What type of glass is used in fibreglass strands?
- Q2. What is the best known aramid material?
- Q3. What method is used to stiffen carbon fibre materials?

ANTICIPATED ANSWERS:

- A1. Silica glass.
- A2. Kevlar®.
- A3. Immersing cross-directional layers of carbon fibres in a matrix compound such as epoxy plastic.

END OF LESSON CONFIRMATION**QUESTIONS:**

- Q1. What are the altitudes of LEO, MEO and GEO orbits?
- Q2. What is the major gas found in LEO?
- Q3. What is the most commonly used metal for spacecraft structure?

ANTICIPATED ANSWERS:

- A1. LEO extends up to 1 000 km, MEO is above 1 000 km and extends up to 35 000 km, and GEO is 35 000 km and higher.
- A2. The major gas in LEO is AO.
- A3. Aluminum is the most commonly used metal for spacecraft structure.

CONCLUSION

HOMEWORK / READING / PRACTICE

Nil.

METHOD OF EVALUATION

Nil.

CLOSING STATEMENT

The study of materials used in aerospace construction is a rapidly growing field that holds immense opportunity for development. Space travel demands accurate and creative materials applications.

INSTRUCTOR NOTES / REMARKS

Cadets who are qualified Advanced Aerospace may assist with this instruction.

REFERENCES

C3-136 ISBN 0-88487-207-6 Sanderson Training Systems (2001). *A&P technician airframe textbook*. Englewood, CO: Jeppesen Sanderson Inc.

C3-294 Silverman, E. M. (1995). *Space environmental effects on spacecraft: LEO materials selection guide*. Hampton, VA: NASA Langley Research Center. Retrieved November 27, 2008, from <http://see.msfc.nasa.gov/mp/NASA-95-cr4661pt1.pdf>

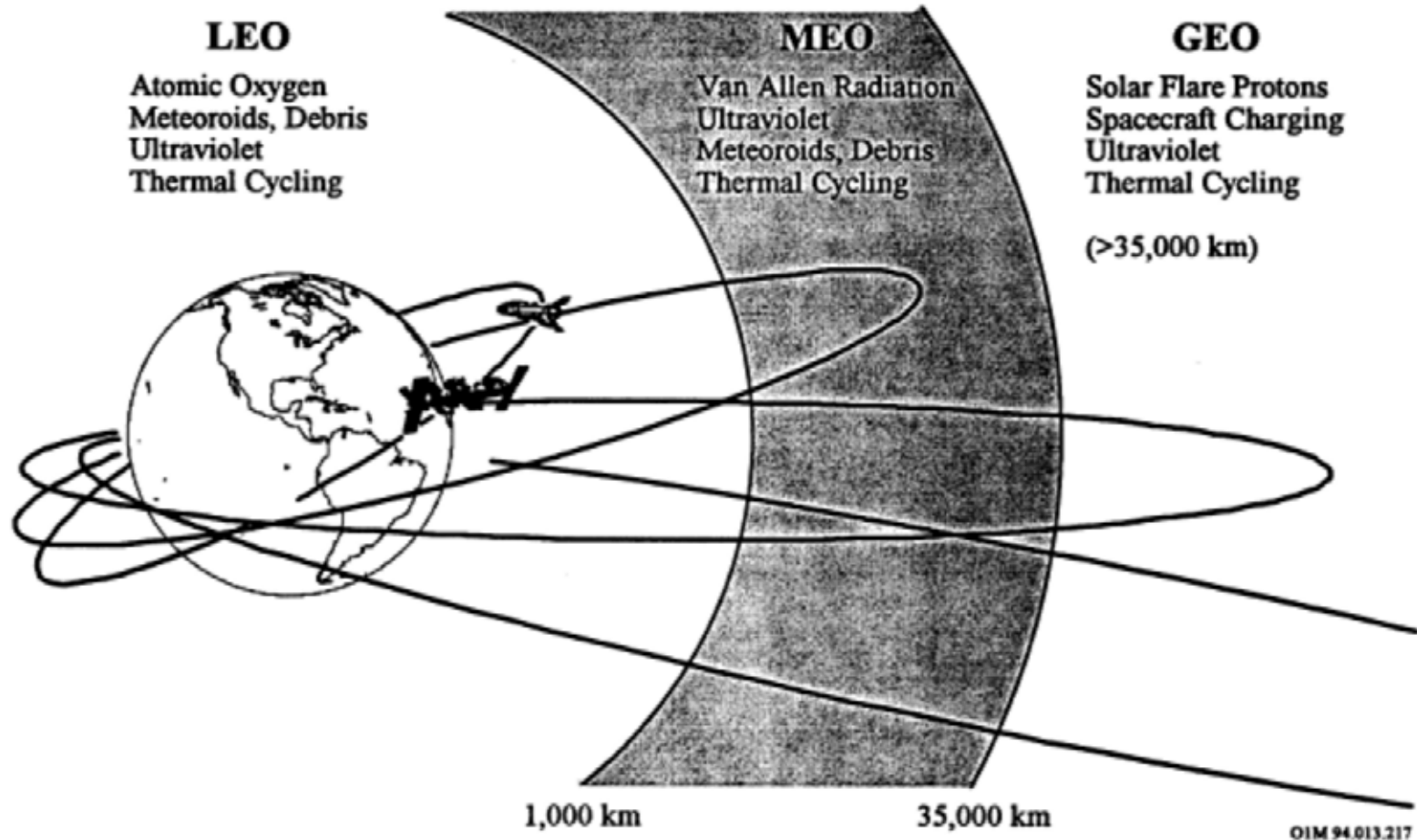

Figure A-1 Variation of Space Environments With Altitude

Note. From *Space Environmental Effects on Spacecraft: LEO Materials Selection Guide*, by E. M. Silverman, 1995, Hampton, VA: NASA Langley Research Center. Retrieved November 27, 2008, from <http://see.msfc.nasa.gov/mp/NASA-95-cr4661pt1.pdf>

Impact	Significance
10	Effects produced will negate the mission
9	Effects produced may negate the mission
8	Effects produced will shorten the mission
7	Effects produced may shorten the mission
6	Effects produced will reduce mission effectiveness
5	Effects produced may reduce mission effectiveness
4	Effects produced will require design changes
3	Effects produced may require design changes
2	Effects produced will cause upsets
1	Effects produced may cause upsets
0	Effects produced can be ignored

Figure A-2 Relative Ranking of the Space Environment Impact on Mission

Note. From *Space Environmental Effects on Spacecraft: LEO Materials Selection Guide*, by E. M. Silverman, 1995, Hampton, VA: NASA Langley Research Center. Retrieved November 27, 2008, from <http://see.msfc.nasa.gov/mp/NASA-95-cr4661pt1.pdf>

Spacecraft Environment	LEO ⁽¹⁾ Low Incl.	LEO High Incl.	MEO ⁽²⁾	GEO ⁽³⁾	Int'l Space Station 500 km 51.6° incl	GPS 20,000km 55° incl
Direct Sunlight	4 ⁽⁴⁾	4	4	4	4	4
Gravity Field	3	3	3	0	3	0
Magnetic Field	3	3	3	0	3	0
Van Allen Belts	0-5	2-5	8-5	1	2-5	5
Solar flare Particles	0	4	3	5	4	3
Galactic Cosmic Rays	0	4	3	5	4	3
Debris Objects	7	7	3-0	3	7	0
Micrometeoroids	3	3	3	3	3	3
Ionosphere	3	3	1	0	3	0
Hot Plasma	0	3	0	5	0	3
Neutral Gases	9-7	9-7	3-0	0	9-7	0

Figure A-3 Space Environmental Effects

Note. From *Space Environmental Effects on Spacecraft: LEO Materials Selection Guide*, by E. M. Silverman, 1995, Hampton, VA: NASA Langley Research Center. Retrieved November 27, 2008, from <http://see.msfc.nasa.gov/mp/NASA-95-cr4661pt1.pdf>

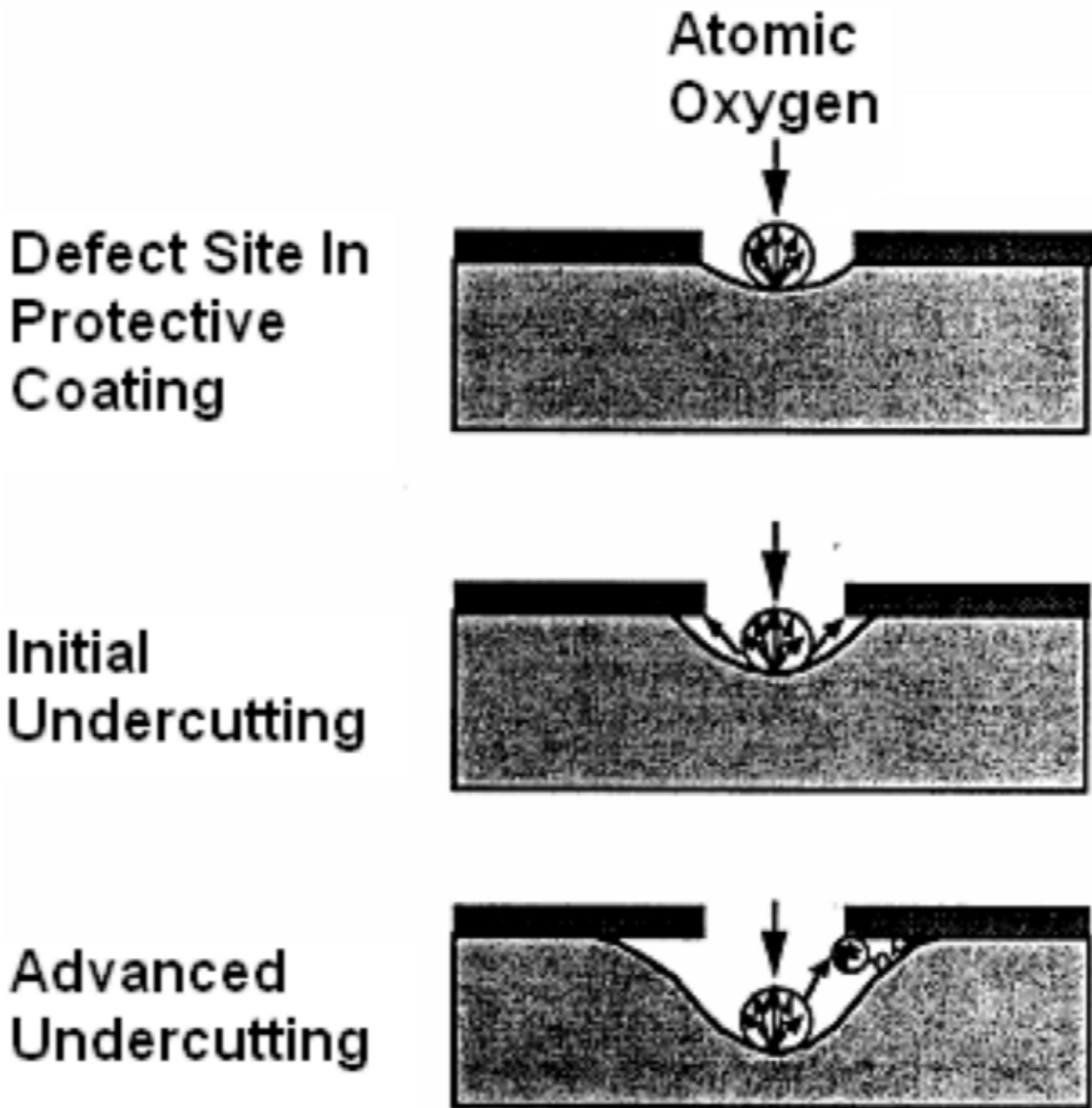

Figure A-4 Atomic Oxygen Undercutting

Note. From *Space Environmental Effects on Spacecraft: LEO Materials Selection Guide*, by E. M. Silverman, 1995, Hampton, VA: NASA Langley Research Center. Retrieved November 27, 2008, from <http://see.msfc.nasa.gov/mp/NASA-95-cr4661pt1.pdf>

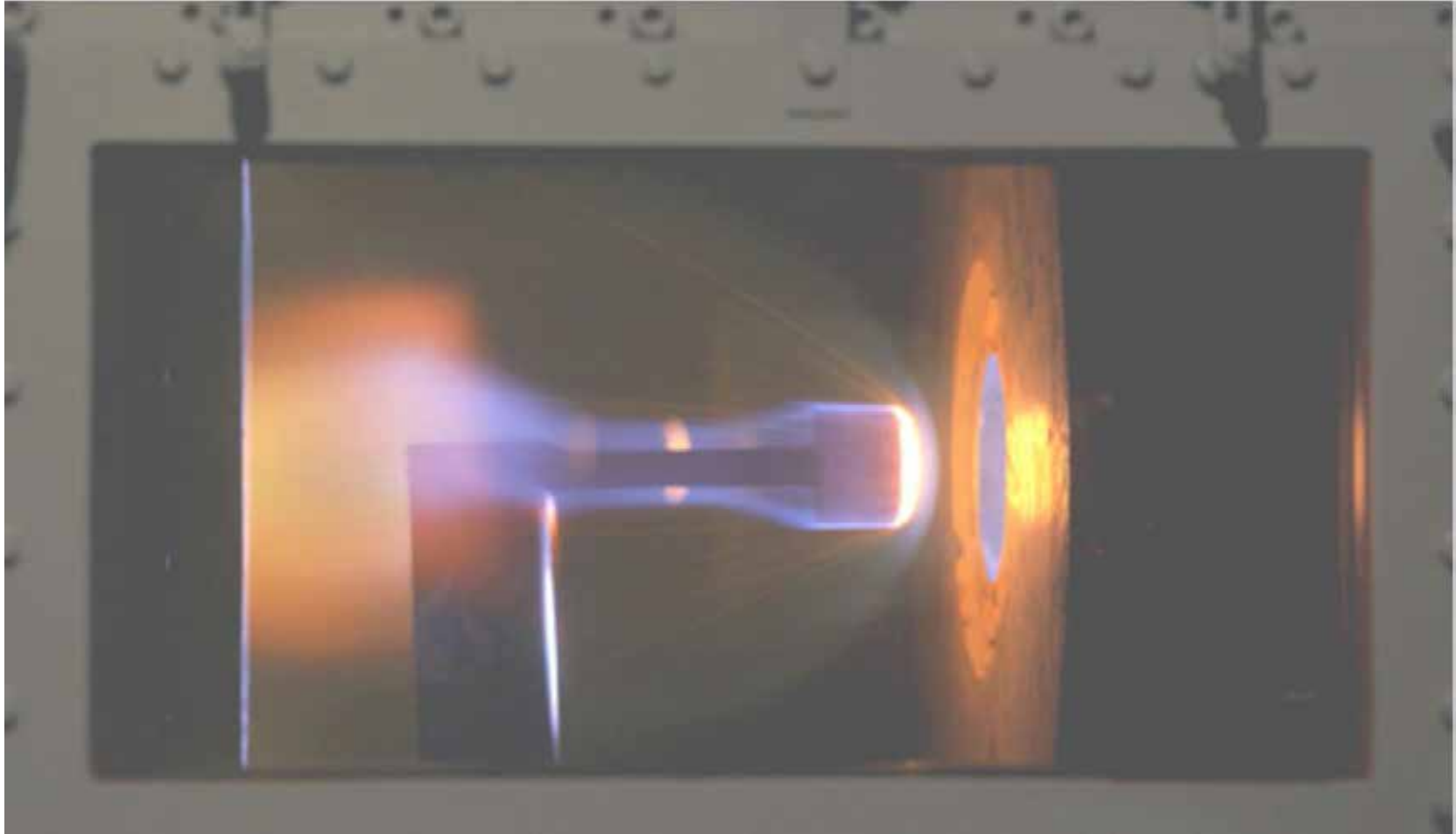

Figure B-1 Testing Thermal Insulation in a Wind Tunnel

Note. From "US Centennial of Flight Commission", 2004, *Shuttle Thermal Protection System*. Retrieved November 25, 2007, from http://www.centennialofflight.gov/essay/Evolution_of_Technology/TPS/Tech41.htm

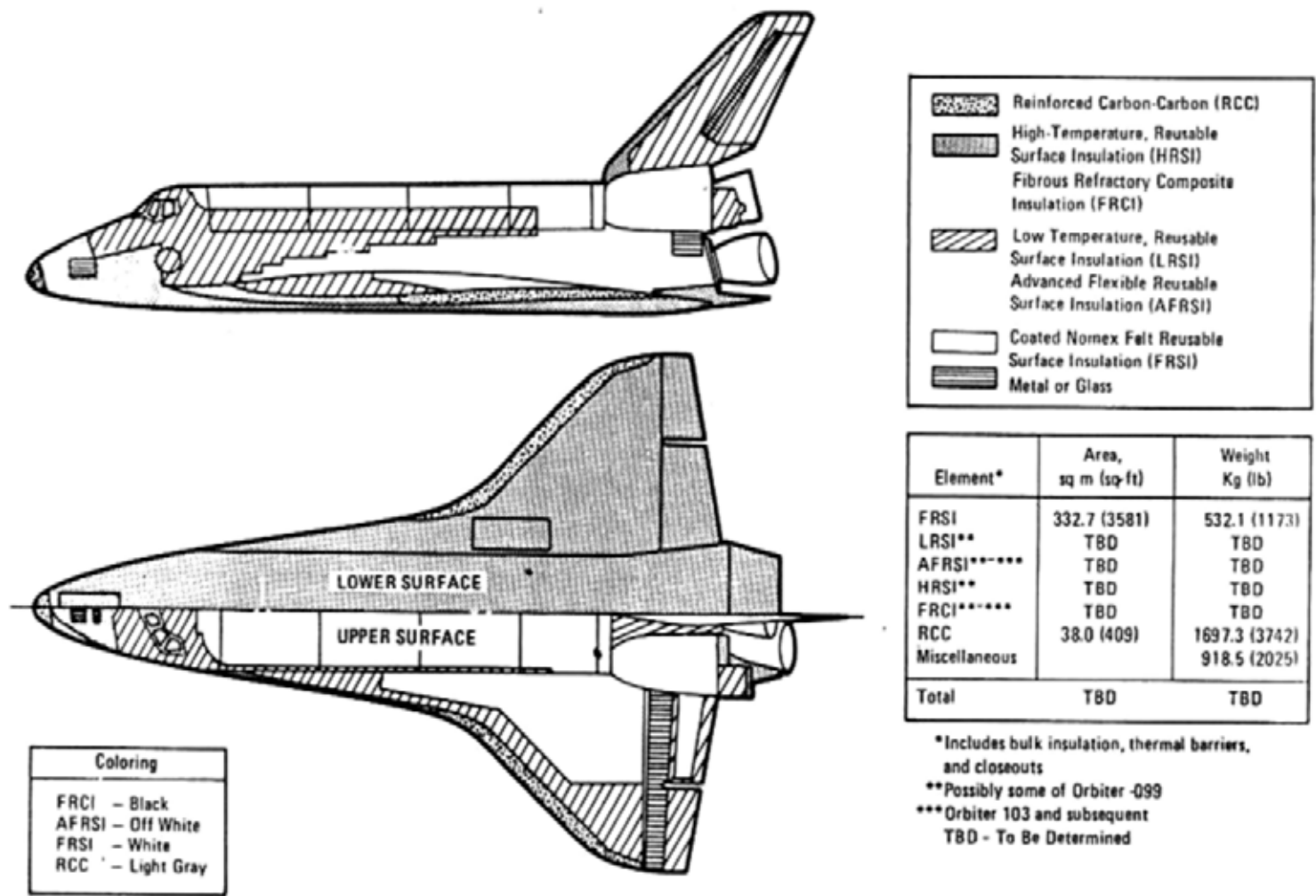

Figure B-2 Orbiter Thermal Protection System

Note. From "US Centennial of Flight Commission", 2004, *Shuttle Thermal Protection System*. Retrieved November 25, 2007, from http://www.centennialofflight.gov/essay/Evolution_of_Technology/TPS/Tech41.htm



Figure B-3 Repairing TPS on Columbia

Note. From "US Centennial of Flight Commission", 2004, *Shuttle Thermal Protection System*. Retrieved November 25, 2007, from http://www.centennialofflight.gov/essay/Evolution_of_Technology/TPS/Tech41.htm

THIS PAGE INTENTIONALLY LEFT BLANK



**ROYAL CANADIAN AIR CADETS
PROFICIENCY LEVEL FOUR
INSTRUCTIONAL GUIDE**



SECTION 2

EO M440.02 – DESCRIBE CANADIAN SATELLITES

Total Time:	30 min
-------------	--------

PREPARATION

PRE-LESSON INSTRUCTIONS

Resources needed for the delivery of this lesson are listed in the lesson specification located in A-CR-CCP-804/PG-001, *Proficiency Level Four Qualification Standard and Plan*, Chapter 4. Specific uses for said resources are identified throughout the instructional guide within the TP for which they are required.

Review the lesson content and become familiar with the material prior to delivering the lesson.

Make slides of Attachments A–C.

PRE-LESSON ASSIGNMENT

Nil.

APPROACH

An interactive lecture was chosen for this lesson to orient the cadets to Canadian satellites and to generate interest in the subject.

INTRODUCTION

REVIEW

Nil.

OBJECTIVES

By the end of this lesson the cadet shall be expected to describe selected Canadian satellites.

IMPORTANCE

It is important for cadets to be familiar with Canadian satellites so they can appreciate the Canadian space program, which is an important element of air cadet training.

Teaching Point 1**Identify aspects of the Alouette program.**

Time: 5 min

Method: Interactive Lecture

HISTORY

Launched on September 29, 1962, the Alouette-I scientific satellite marked Canada's entry into the space age and was seen by many as initiating the most progressive space program of that era.



Show the cadets Figures A-1 and A-2 located at Attachment A.

With the Alouette launch, Canada became the first nation after the Soviet and American superpowers, to design and build its own artificial Earth satellite.

PURPOSE

The development of Alouette-I came as a result of an American invitation, through the newly formed National Aeronautics and Space Administration (NASA) in 1958, for international collaboration in its budding satellite program. Within months, scientists at Canada's Defence and Research Telecommunications Establishment (DRTE) submitted a proposal to NASA for a Canadian satellite that could monitor the top of the ionosphere, an upper layer of the earth's atmosphere that is ionized by solar wind.



The solar wind is so hot it becomes fully ionized plasma, which means that the atoms have become separated from their electrons. This streaming plasma flows past Earth, affects the Earth's magnetic field and magnetosphere, and creates the ionosphere by removing electrons from atoms of gas in the atmosphere. The Earth's atmosphere receives a lot of energy from the sun in the form of radiation—about 1 370 watts per square metre. That is enough energy to power six desktop computers, coming from an area that would barely hold one computer.

Ground-based techniques used to study the ionosphere are similar to radar. Radio pulses are transmitted from the ground and reflected back by the ionized layer of atmosphere. The elapsed time is used to calculate the height of the layers. The equipment used to make these measurements is an ionosonde. The Canadian proposal was to integrate an ionosonde into a satellite.

The objectives were twofold, both primary and scientific:

1. Primary objectives were:
 - a. to bring Canada into the space age by developing a space capability;
 - b. to contribute to space engineering and technology; and
 - c. to improve the capability of high frequency (HF) radio communications by studying the ionosphere from above.

2. Scientific objectives were:
 - a. to measure the electron density distribution in the ionosphere at altitudes between 300 and 1 000 km;
 - b. to study, for a one-year period, the variations of electron density distribution with regard to time of day and latitude under varying magnetic and auroral conditions, with particular emphasis on high latitude effects; and
 - c. to determine electron densities in the vicinity of the satellite by means of galactic noise measurement and to make observations of related physical phenomena, such as the flux of energetic particles.

ACCOMPLISHMENTS

Alouette-I was a tremendous success. The conservative research approach adopted by the DRTE team paid off as the satellite eventually stretched its one-year design life into an unprecedented 10-year mission, producing more than one million images of the ionosphere.

Following the success of Alouette-I, Canada and the United States signed an agreement to launch further satellites under a new program called International Satellites for Ionospheric Studies (ISIS). Under the ISIS program, the Alouette backup model, Alouette-II, was refurbished and flown in 1965 and two new satellites, named ISIS I and ISIS II, were successfully launched in 1969 and 1970 respectively.

CONFIRMATION OF TEACHING POINT 1

QUESTIONS:

- Q1. What was the year of Alouette's first launch?
- Q2. What was Alouette designed to do?
- Q3. What program followed the success of Alouette?

ANTICIPATED ANSWERS:

- A1. 1962.
- A2. To monitor the ionosphere from above.
- A3. The ISIS program.

Teaching Point 2

Identify aspects of the Microvariability and Oscillation of Stars (MOST) mission.

Time: 10 min

Method: Interactive Lecture

HISTORY

MOST is Canada's space telescope in orbit. It is sometimes referred to as the "Hubble Space Telescope" due to its physical size, despite its effectiveness and accomplishments.



Show the cadets Figures B-1 and B-2 located at Attachment B.

The four partners who designed and created MOST are:

- Canadian Space Agency (CSA),
- University of British Columbia (UBC) (Physics and Astronomy),
- University of Toronto Institute for Aerospace Studies (UTIAS), and
- Dynacon Enterprises Limited (main contractor, mission operations).

The MOST science team includes representatives from various organizations, which include:

- University of British Columbia (UBC),
- St. Mary's University,
- L'Université de Montréal,
- University of Toronto David Dunlap Observatory (DDO),
- Harvard-Smithsonian Center, and
- University of Vienna.

MOST was carried aloft aboard a Russian three-stage rocket on June 30, 2003, from a launch site in northern Russia (Plesetsk). MOST was injected into a low-Earth polar orbit at approximately 820 km altitude with an orbital period of approximately 100 minutes in a sun-synchronous mode remaining over the Earth's terminator (the line between day and night).



Sun-synchronous means that, although MOST orbits Earth, it also maintains its orientation to the sun.



Show the cadets Figures B-3 to B-5 located at Attachment B. For orbit information, cadets can visit <http://www.astro.ubc.ca/MOST/galleries.html#movies>

From that vantage point, MOST will have a Continuous Viewing Zone (CVZ) spanning declinations from about -19 to +36 degrees, in which a selected target star will remain observable for up to 60 days without interruption.



UBC has a collection of MOST training eClips and explanations located at their MOST website at <http://www.astro.ubc.ca/MOST/galleries.html#movies>

PURPOSE

The stated purposes of the MOST space telescope are the detection and characterization of:

- acoustic oscillations in sun-like stars, including very old stars (metal-poor subdwarfs) and magnetic stars (roAp), to probe seismically their structures and ages;
- reflected light from giant exoplanets closely orbiting sun-like stars, to reveal their sizes and atmospheric compositions; and
- turbulent variations in massive evolved (Wolf-Rayet) stars to understand how they add gas to the interstellar medium.

MOST, therefore, is an attempt to answer important question about stars, such as:

- Can we understand our sun in the context of other stars?
- By putting a birthdate on the oldest stars in the solar neighbourhood, can we set a limit on the age of the universe?
- How do strong magnetic fields affect the physics of other stars and our own sun?
- What are mysterious planets around other stars really like?
- How did the atoms that make up our planet and our bodies escape from stars in the first place?

ACCOMPLISHMENTS

Although the MOST space telescope is often referred to as the Humble telescope because of its size next to the Hubble Space Telescope (HST), the accomplishments of MOST are anything but humble. MOST turned out to be a precocious child. The team of scientists and engineers—located from coast to coast across Canada and in Harvard and Vienna—has extended the capabilities of this "little telescope that could" to explore exoplanets (alien worlds around other stars). MOST has measured the properties of several of these planets, which are invisible even to the largest telescopes. Among the findings of MOST is a planet whose atmosphere is either so clear or so hazy that it reflects only four percent of the light it receives from its parent sun.



For information about MOST observations, visit the MOST Science website at <http://www.astro.ubc.ca/MOST/science.html>

CONFIRMATION OF TEACHING POINT 2

QUESTIONS:

- Q1. What year was that the MOST telescope carried aloft?
- Q2. What sort of orbit does MOST have?
- Q3. What viewing opportunity does MOST's orbit provide?

ANTICIPATED ANSWERS:

- A1. 2003.
- A2. A low-Earth polar orbit.
- A3. A CVZ spanning declinations from about -19 to +36 degrees, in which a selected target star will remain observable for up to 60 days without interruption.

Teaching Point 3**Identify aspects of the RADARSAT program.**

Time: 10 min

Method: Interactive Lecture

HISTORY

The RADARSAT program was born out of the need for effective monitoring of Canada's waters. Canada is a world leader in the operational use of space radar for sea ice monitoring. Earth-observation satellites have an advantage over aerial surveillance missions. Satellites operate day and night in all weather conditions and provide timely coverage of vast areas.

Show the cadets Figure C-1 located at Attachment C.

RADARSAT is Canada's first series of remote-sensing satellites. RADARSAT-1 was launched in 1995 and RADARSAT-2 in 2007. These satellites focus on the use of radar sensors to provide unique information about the Earth's surface through most weather conditions and darkness. A technique known as synthetic-aperture radar (SAR) is used by RADARSAT satellites to increase the resolution of images by taking advantage of the fact that the satellite's small aperture is constantly moving. The many echo waveforms received at the different antenna positions are then post-processed by a computer in order to resolve the target with high definition. Post-processing by a computer is also the technique used by Global Positioning System (GPS) receivers to eliminate location ambiguities.

PURPOSE**Marine Surveillance**

Worldwide offshore resource-based operations such as fishing, oil and gas exploration and production have intensified over the past few decades. Government and industry require powerful solutions for assessing the resources and risks associated with the ocean environment. To monitor the world's oceans, Canada has provided radar data for operational applications such as ship detection, oil spill monitoring, and wind and surface-wave field estimation.

RADARSAT-2 improves ship detection with its ultra-fine beam mode, which can resolve objects down to 3 m on a side, and offers the potential for ship classification.

Disaster Management

Radar satellites are key resources in a variety of disaster management scenarios. The data has been used effectively in disaster responses such as earthquakes, tsunamis, floods, landslides, forest fires, and other natural or technological disasters such as a large oil spill in Japan. On January 2, 1997, the Nakhodka, a Russian oil tanker, broke apart during a storm 130 km (80 miles) off the coast of Japan's Shimane Prefecture.



Show the cadets Figure C-2 located at Attachment C. The inset view in Figure C-2 shows the location of the Wakasa Bay nuclear reactors.

At one point the spill threatened one of the most concentrated areas of nuclear reactors in the world. The oil slicks came close to the 15 reactors in Japan's Wakasa Bay but the cleanup effort was able to keep the oil from seeping into the reactor's intake pipes, which serve to cool the reactors with seawater. Officials stated that in the worst case, if the oil had seeped into the pipes, plant operators would simply have been forced to suspend power. RADARSAT images served to define the extent and shape of the oil spill during this disaster.



The ability to deliver data in near-real time is essential for relief operations to map and monitor damage and for assessing impact.

RADARSAT-2 reduces planning lead times for data acquisition and, because it can look both right and left, provides more revisits and up-to-date data than its predecessor.

There are unlimited uses for RADARSAT image data. An example is the use of RADARSAT images by Research Institute for Advanced Mechanics (RIAM) of the Kyushu University Dynamics Simulation Research Center to develop a computer model of the Nakhodka oil spill.



Show the cadets Figure C-3 located at Attachment C.

RADARSAT images, such as the ones seen in Figure C-3, were used in creating computer programs that simulate the spreading of spilled oil.



Show the cadets Figure C-4 located at Attachment C.

Dated images of the computer program output are shown in Figure C-4. Computer analysis is now available to predict the effects of future oil spills and assist with environmental cleanup.

Hydrology

Water is one of Earth's most precious and widely used resources. RADARSAT-2 enhances soil moisture measurement, and snow pack monitoring and analysis, while improving the potential for SAR in wetland mapping and discrimination. This will benefit mapping applications involving coastlines, tidal and near-shore terrestrial areas, and near-shore bathymetry (depth measurements).

Mapping

Mapping covers a broad range of activities, including the creation of Digital Elevation Models (DEMs), the detection and mapping of centimetre-scale movements at the Earth's surface (InSAR), and the extraction and identification of features to support environment management and security.

RADARSAT-2's advanced technology provides improved capabilities for mapping. Highly accurate positional information and control over the RADARSAT-2 orbit ensures absolute quality for end products, such as DEMs and InSAR.

Geology

Satellite radar data is very useful in geological exploration and mapping activities for petroleum and mineral resources. Canadian radar data is used for both onshore and offshore exploration and mapping and to monitor and detect oil seeps, which reduces the risk and cost of drilling. The Southern African Institute of Mining and Metallurgy reports the use of remote sensing by diamond mining companies in South Africa, listing RADARSAT images as among the most useful.

Agriculture

Abundant harvests and crop yields partly depend on soil dynamics that fluctuate throughout the growing season. Satellite imagery is an efficient method for mapping crop characteristics over large spatial areas and tracking temporal changes in soil and crop conditions.

Built into RADARSAT-2 are several powerful features that respond directly to the needs of the agricultural sector. Valuable crop information can be extracted from one RADARSAT-2 image and there is no need for image data acquisition over several dates. RADARSAT provides important information about climate change.

Forestry

With more than 30 percent of the Earth's total land area covered in forests, it is no small feat to assess and monitor forest resources. Satellite imagery is the most efficient method for coverage of forested areas.

Several applications in forestry have benefited from Canadian radar data, in particular clear-cut mapping. High-resolution data from RADARSAT-2 may improve forest-type mapping using textural analysis.

ACCOMPLISHMENTS

The RADARSAT Program continues Canada's tradition of providing world leadership in advancing Earth-observation technologies and techniques. Natural Resources Canada—one of RADARSAT's main customers—observes that RADARSAT's unparalleled operational flexibility and reliable delivery provides high quality and cost-effective data to researchers and environmental professionals world-wide.

CONFIRMATION OF TEACHING POINT 3

QUESTIONS:

- Q1. What kind of satellites are RADARSAT satellites?
- Q2. In what year was the first RADARSAT launch?
- Q3. What are three purposes of the RADARSAT program?

ANTICIPATED ANSWERS:

- A1. Earth-observation satellites.
- A2. RADARSAT-1 was launched in 1995.
- A3. Any three chosen from: marine surveillance, disaster management, hydrology, mapping, geology, agriculture and / or forestry.

END OF LESSON CONFIRMATION**QUESTIONS:**

- Q1. What job was Alouette designed to do?
- Q2. What does MOST's orbit provide?
- Q3. What are three purposes of the RADARSAT program?

ANTICIPATED ANSWERS:

- A1. To monitor the ionosphere from above.
- A2. A CVZ spanning declinations from about -19 to +36 degrees, in which a selected target star will remain observable for up to 60 days without interruption.
- A3. Any three chosen from: marine surveillance, disaster management, hydrology, mapping, geology, agriculture and / or forestry.

CONCLUSION

HOMEWORK / READING / PRACTICE

Nil.

METHOD OF EVALUATION

Nil.

CLOSING STATEMENT

Canadian space missions affect many aspects of life, from telecommunications to environmental protection and pure science. Intended and unintended applications of Canada's space research continue to benefit other industries.

INSTRUCTOR NOTES / REMARKS

Cadets who are qualified Advanced Aerospace may assist with this instruction.

REFERENCES

C3-253 Canadian Space Agency. (2008). *Alouette I and II*. Retrieved September 29, 2008, from <http://www.space.gc.ca/asc/eng/satellites/alouette.asp>

C3-254 University of British Columbia. (2008). *MOST: Canada's first space telescope*. Retrieved September 29, 2008, from <http://www.astro.ubc.ca/MOST/overview.html#glance>

C3-255 Natural Resources Canada. (2008). *Canada centre for remote sensing: RADARSAT*. Retrieved September 29, 2008, from http://www.ccrs.nrcan.gc.ca/radar/spaceborne/radarsat1/index_e.php

THIS PAGE INTENTIONALLY LEFT BLANK

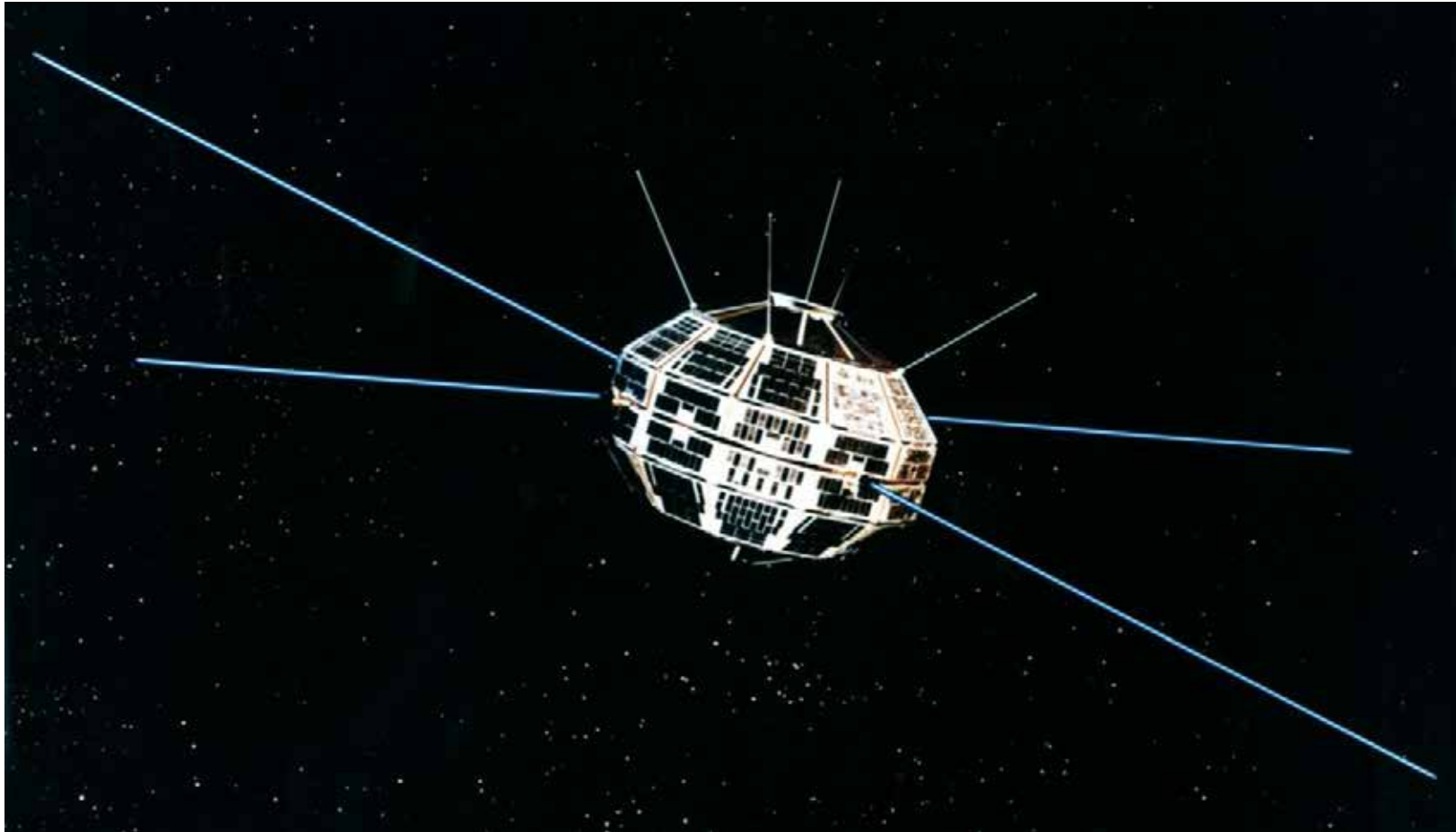

Figure A-1 Alouette-1

Note. From Canadian Space Agency, 2008, *Alouette I and II*. Retrieved October 27, 2008, from http://www.space.gc.ca/asc/app/gallery/results2.asp?session=&image_id=alouette

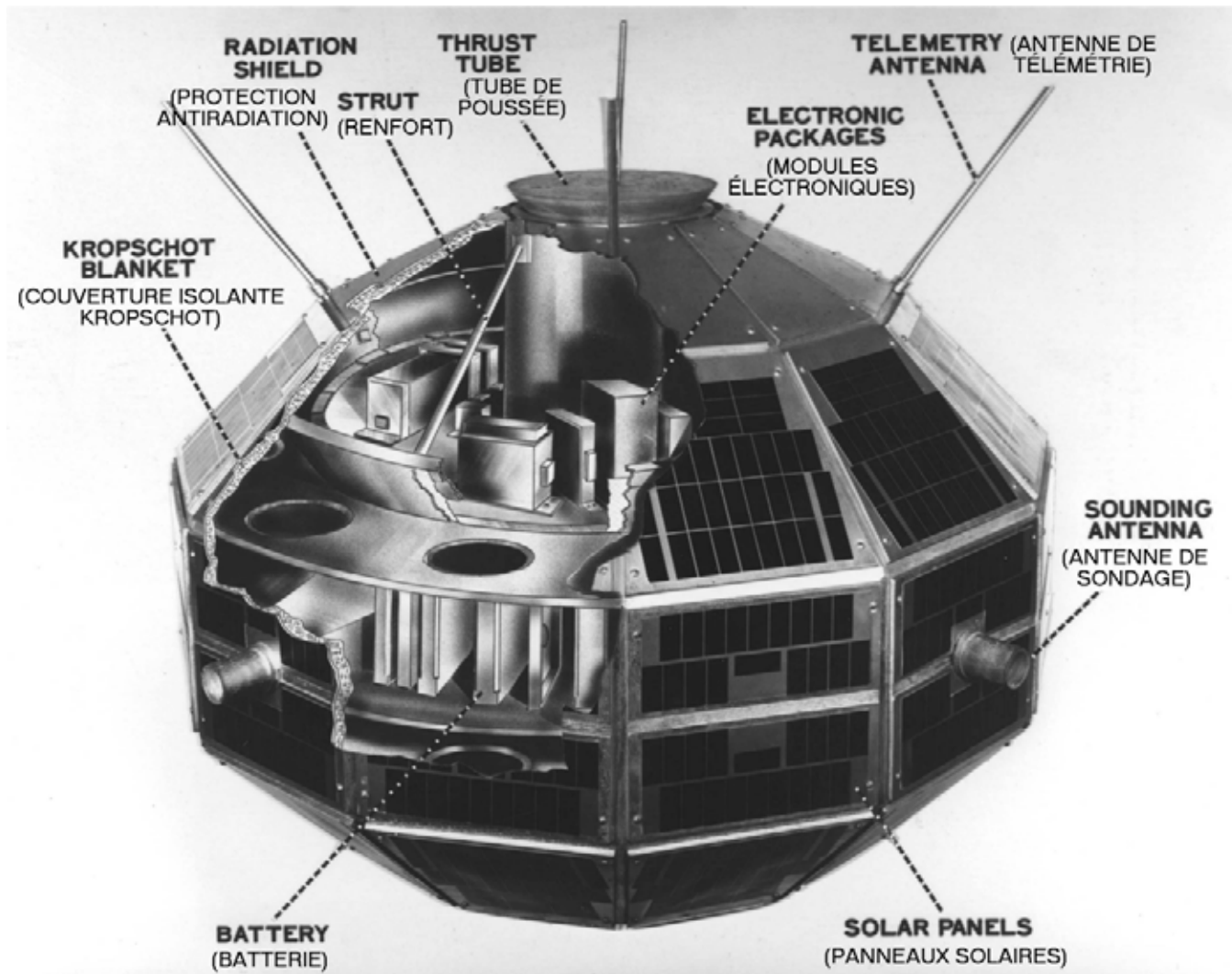

Figure A-2 Alouette-1 Revealed

Note. From Canadian Space Agency, 2008, *Alouette I and II*. Retrieved October 27, 2008, from http://www.space.gc.ca/asc/app/gallery/results2.asp?session=&image_id=jhchapman-03

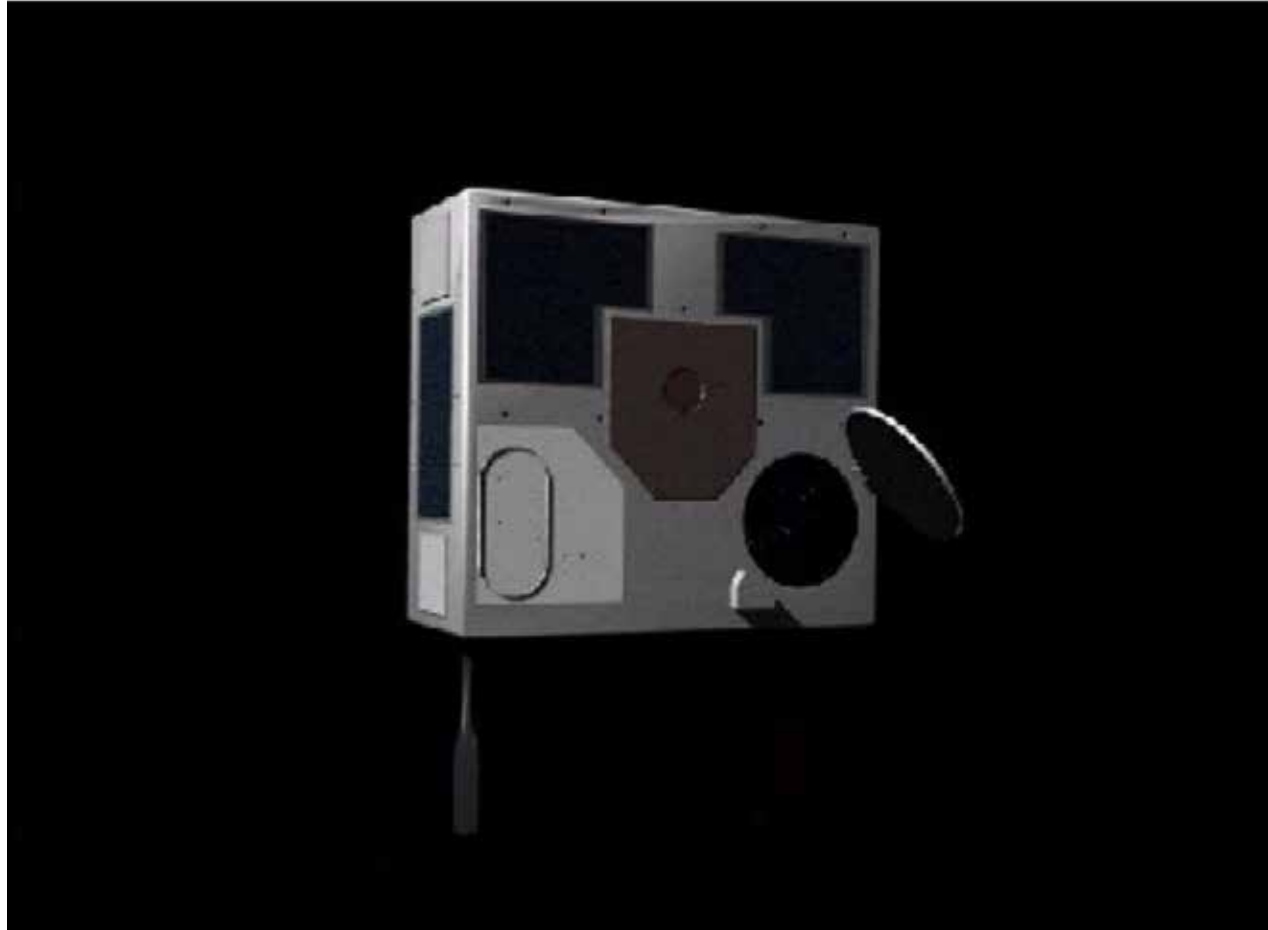

Figure B-1 MOST With Telescope Protective Door Open

Note. From "MOST: Canada's First Space Telescope", 2008, *Galleries*. Retrieved October 27, 2008, from <http://www.astro.ubc.ca/MOST/galleries.html#movies>

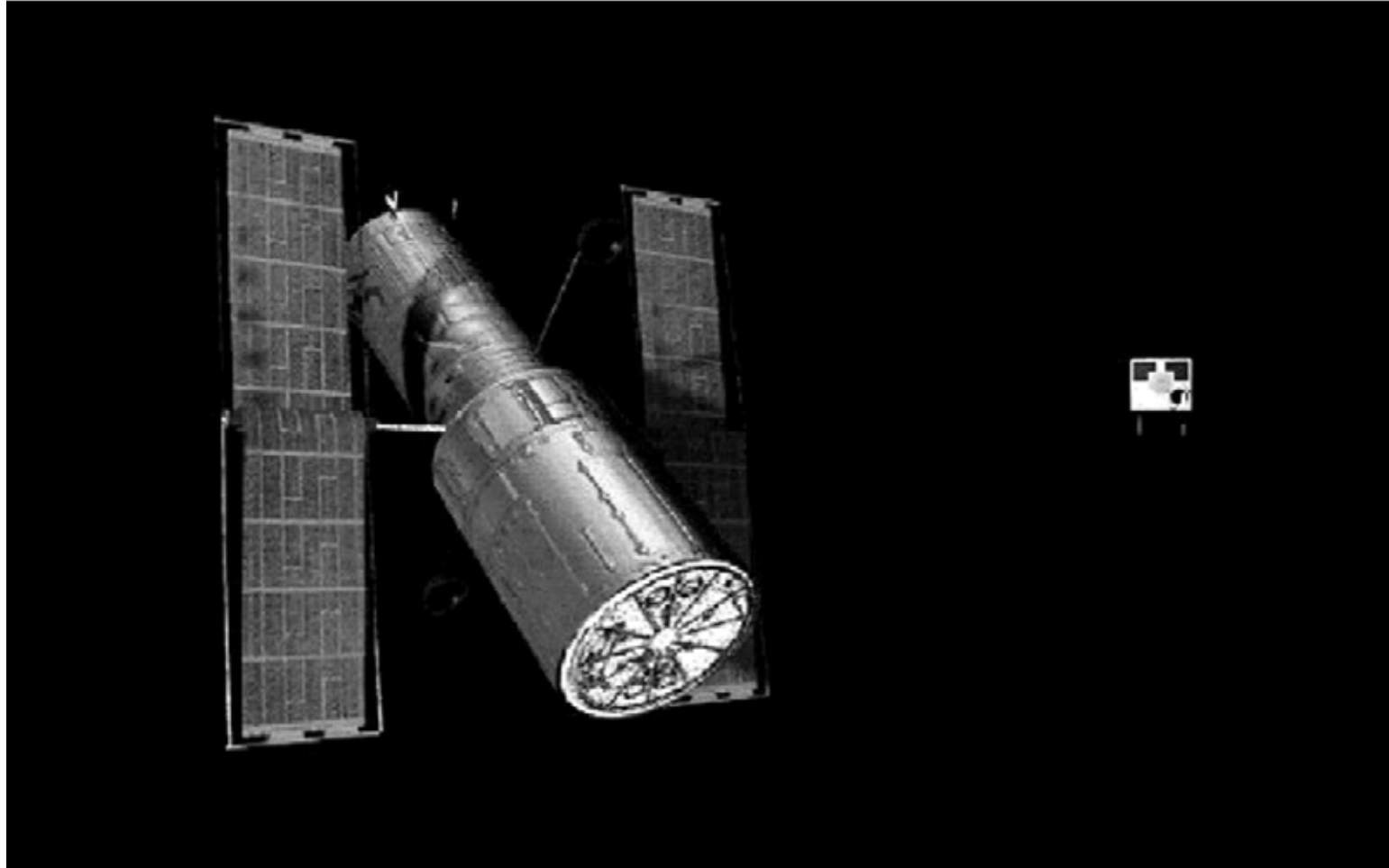

Figure B-2 The Hubble and the Humble to Scale

Note. From "MOST: Canada's First Space Telescope", 2008, *Galleries*. Retrieved October 27, 2008, from <http://www.astro.ubc.ca/MOST/galleries.html#movies>

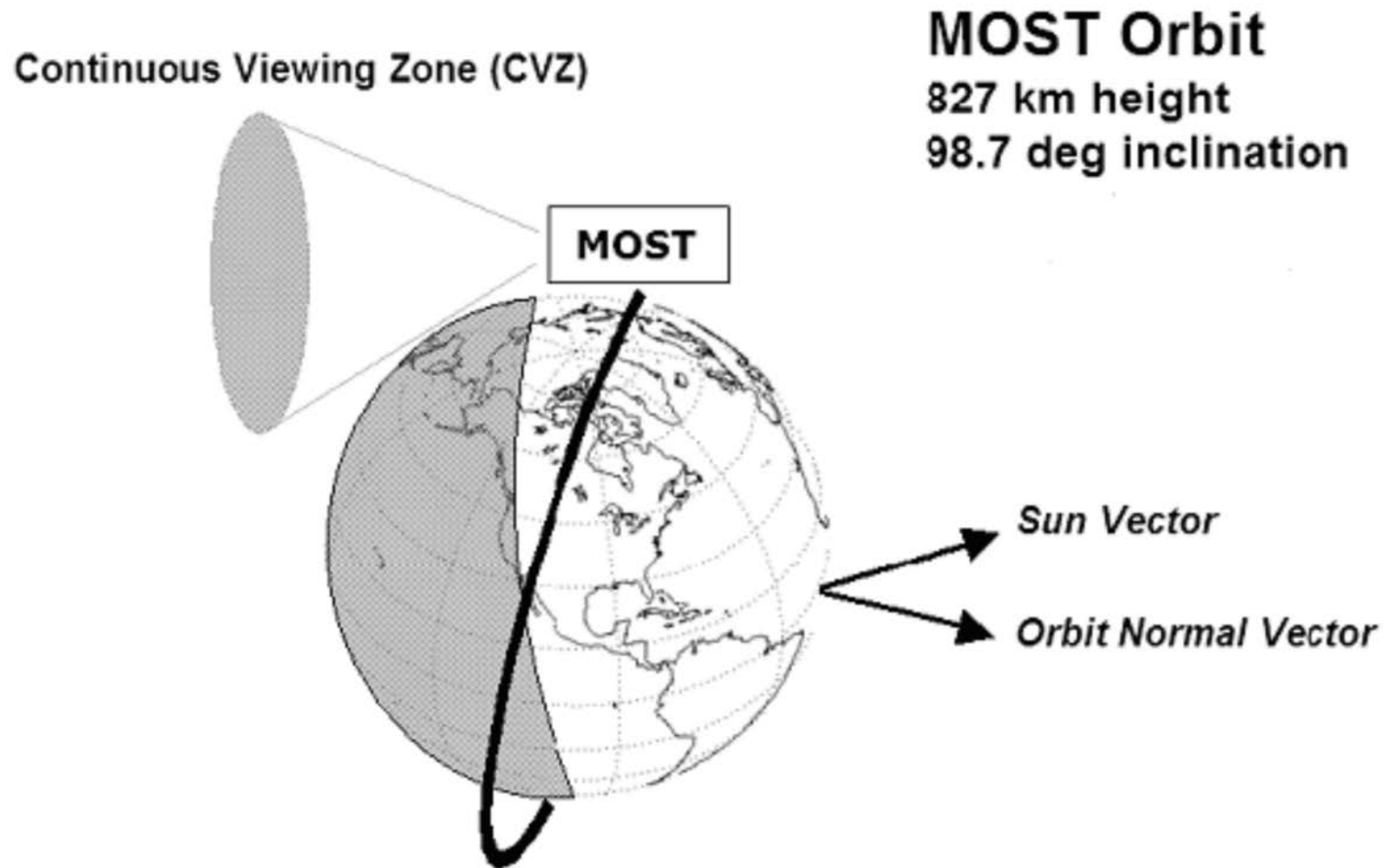

Figure B-3 MOST's Sun-Synchronous Polar Orbit

Note. From *The MOST Asteroseismology Mission: Ultraprecise Photometry from Space*, 2003, by G. Walker, J. Matthews, R. Kuschnig, & R. Johnson. Retrieved October, 20, 2008, from <http://www.astro.ubc.ca/MOST/papers/walker.pdf>

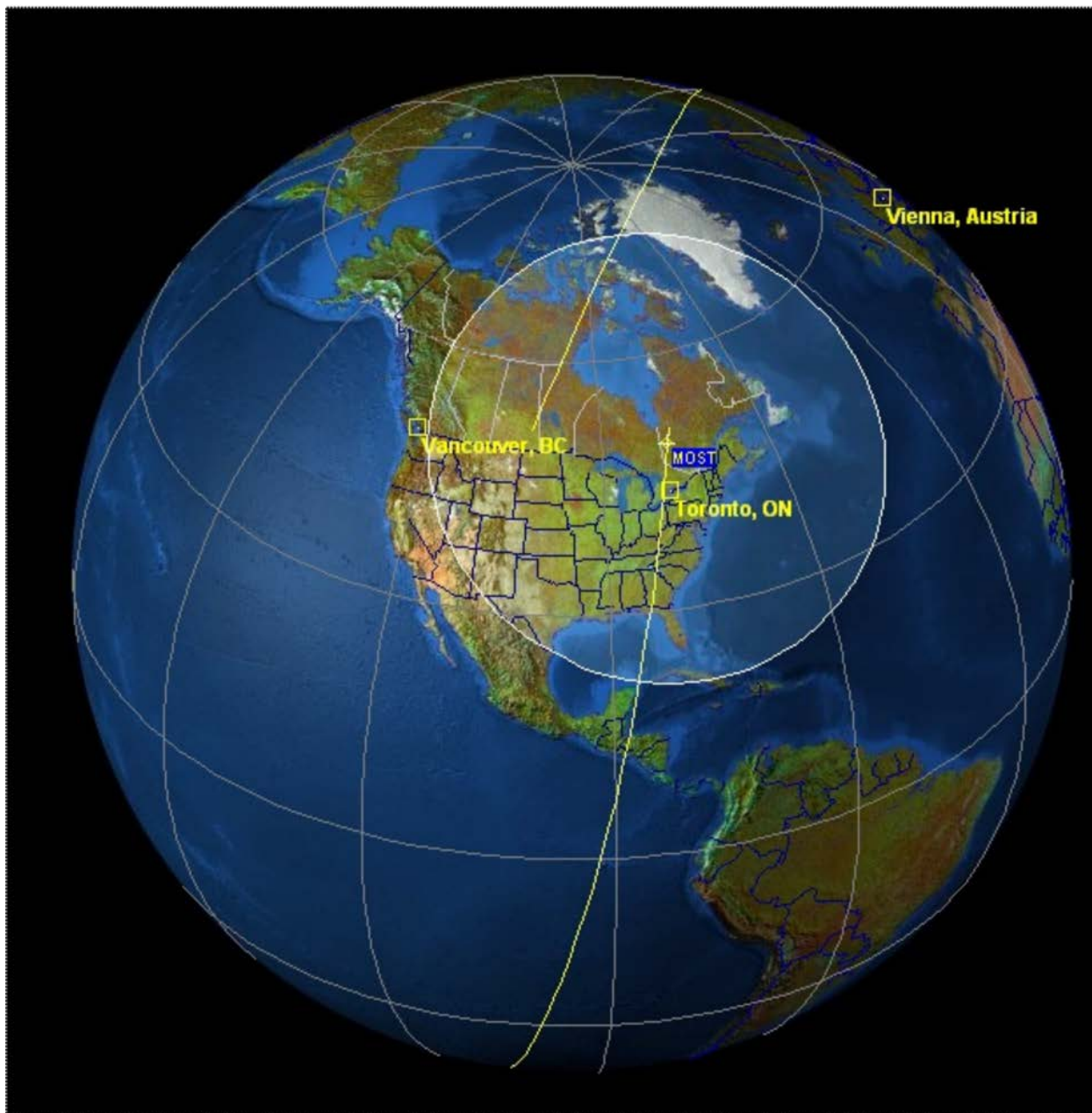

Figure B-4 MOST and Its Ground Stations

Note. From "MOST: Canada's First Space Telescope", 2008, *Galleries*.
Retrieved October 27, 2008, from <http://www.astro.ubc.ca/MOST/galleries.html>



Figure B-5 MOST in Orbit

Note. From "MOST: Canada's First Space Telescope", 2008, *Galleries*. Retrieved October 27, 2008, from <http://www.astro.ubc.ca/MOST/galleries.html>

THIS PAGE INTENTIONALLY LEFT BLANK

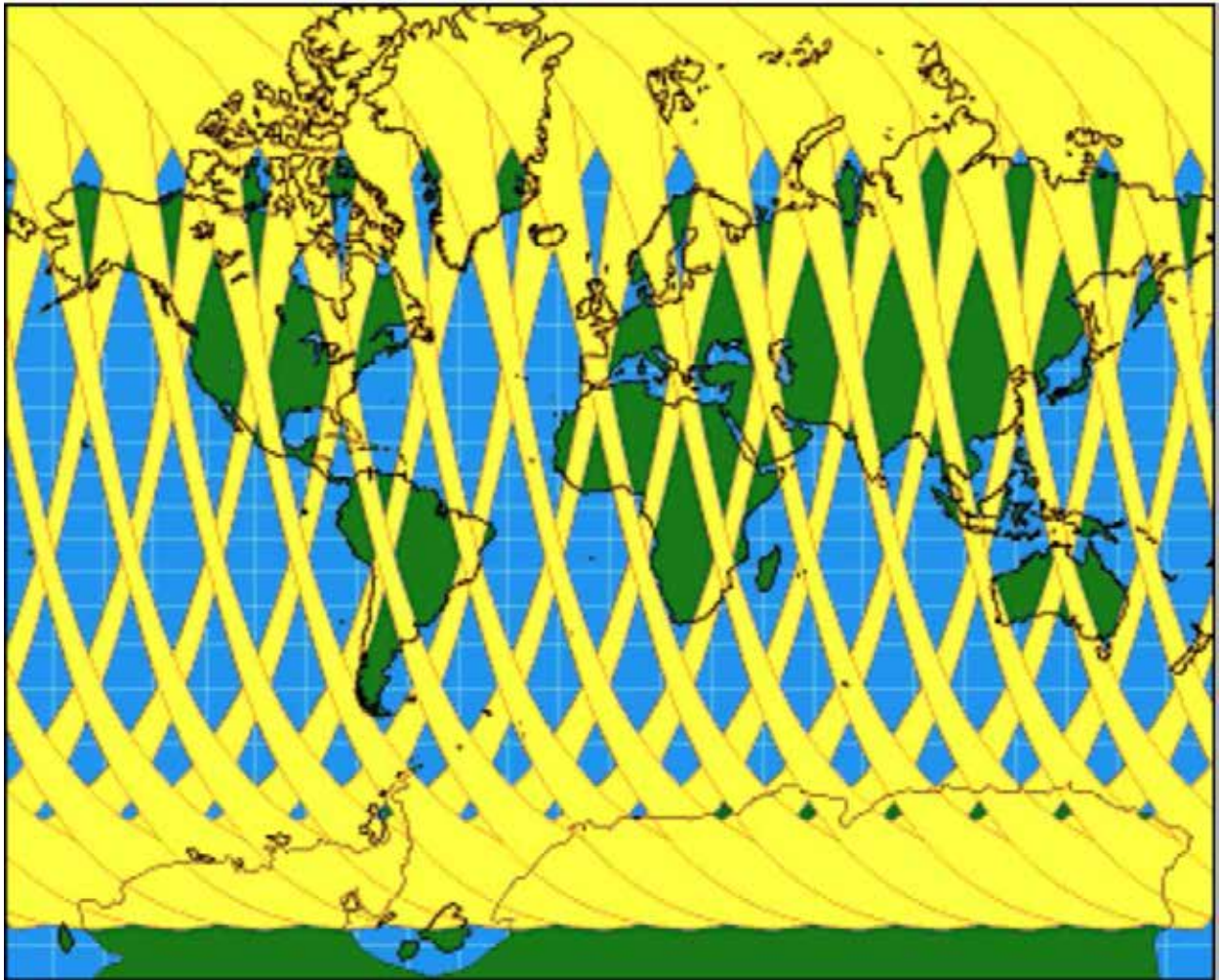

Figure C-1 RADARSAT Coverage

Note. From Natural Resources Canada, 2008, "Canada Centre for Remote Sensing", *RADARSAT-1 Overview*. Retrieved October 27, 2008, from http://www.ccrs.nrcan.gc.ca/radar/spaceborne/radarsat1/specs/index_e.php

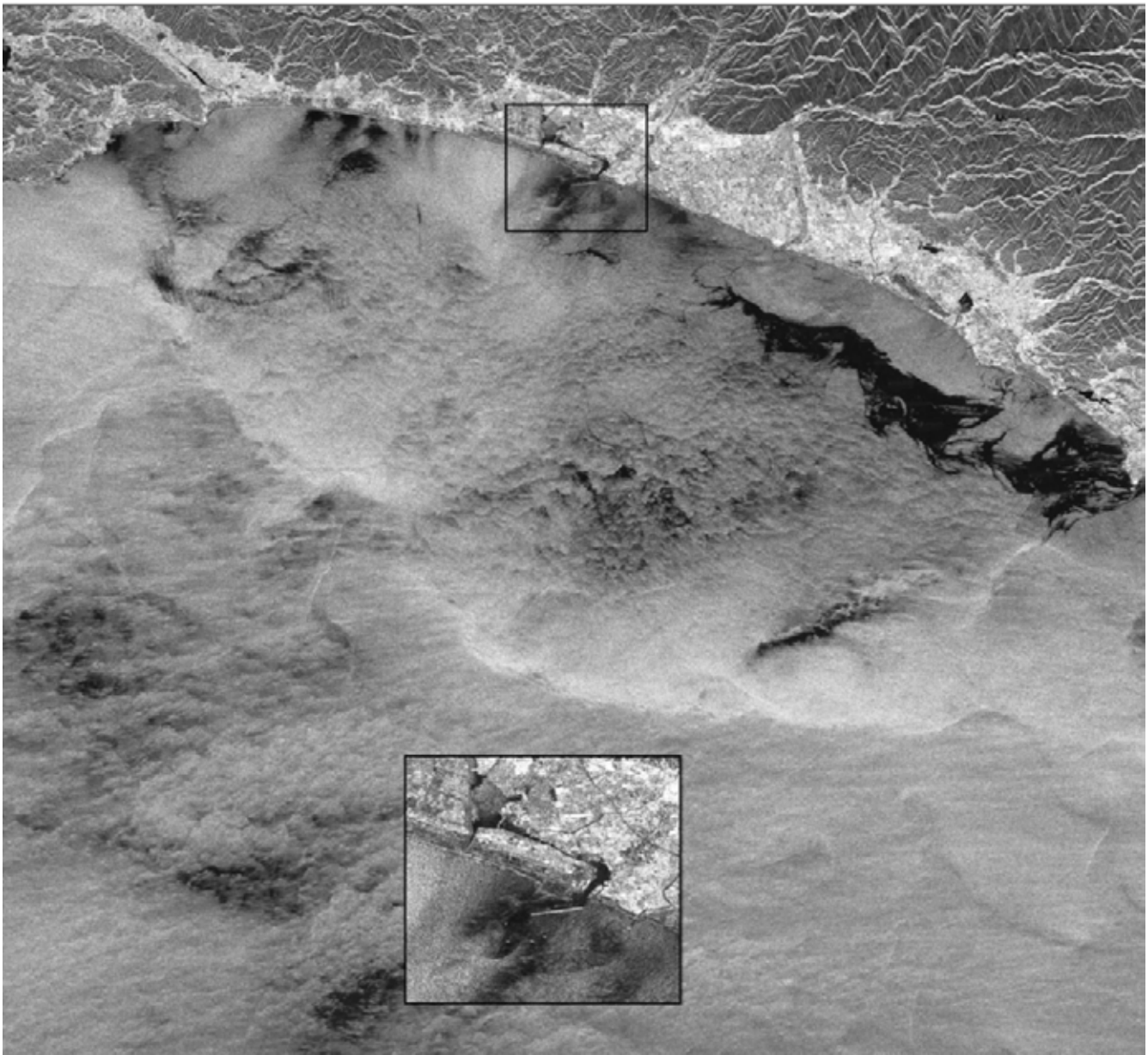
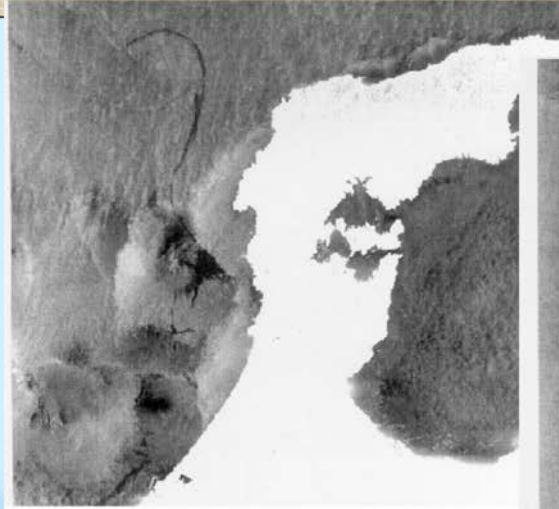

Figure C-2 RADARSAT View of the 1997 Nakhodka Oil Spill in Japan

Note. From "Satellite Operations", 2002, by A. Mahmood, *RADARSAT-1 Disaster Watch Program*. Retrieved October 27, 2008, from http://www.unescap.org/icstd/SPACE/documents/RWDM_Bangkok/Acrobat/CANADA-RADARSAT1-Mahmood.pdf

Satellite observed oil slicks after the *Nakhodka* oil spill in the Japan Sea



(c) CSA 1997

January 10-11, 1997

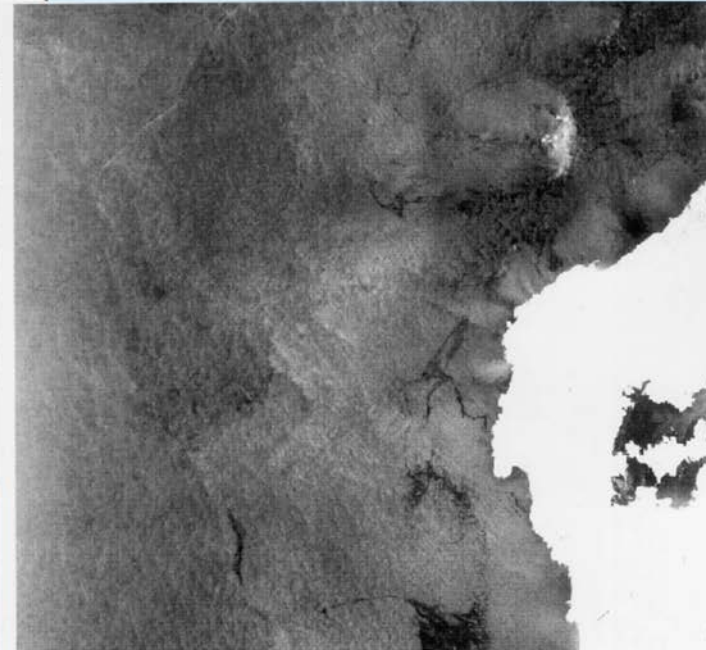

(c) CSA 1997

Source: Japan Remote Sensing Agency, Canadian RADARSAT data

Figure C-3 Nakhodka Oil Spill Images

Note. From Japan Society for the Promotion of Sciences, 2000, "Asian Science Seminar", *Transport of Pollutants in the Air and the Sea of East Asia*. Retrieved October 27, 2008, from http://omg.riam.kyushu-u.ac.jp/~vsm/html/Lecture_20001025.pps

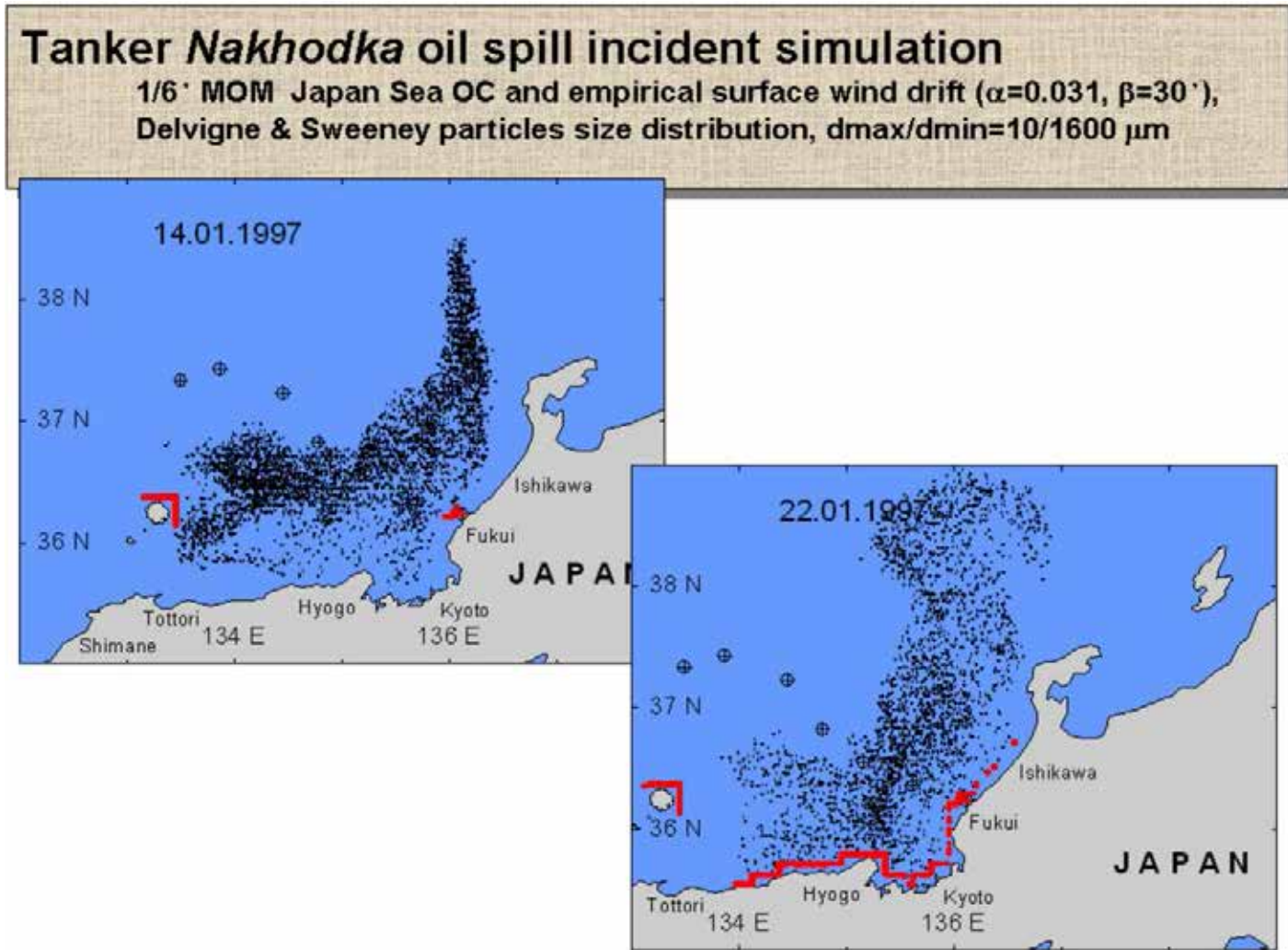

Figure C-4 Computer Simulation of the Nakhodka Oil Spill

Note. From Japan Society for the Promotion of Sciences, 2000, "Asian Science Seminar", *Transport of Pollutants in the Air and the Sea of East Asia*. Retrieved October 27, 2008, from http://omg.riam.kyushu-u.ac.jp/~vsm/html/Lecture_20001025.pps



ROYAL CANADIAN AIR CADETS
PROFICIENCY LEVEL FOUR
INSTRUCTIONAL GUIDE



SECTION 3

EO C440.01 – DESCRIBE MODEL ROCKETRY

Total Time:	60 min
-------------	--------

PREPARATION

PRE-LESSON INSTRUCTIONS

Resources needed for the delivery of this lesson are listed in the lesson specification located in A-CR-CCP-804/PG-001, *Proficiency Level Four Qualification Standard and Plan*, Chapter 4. Specific uses for said resources are identified throughout the instructional guide within the TP for which they are required.

Review the lesson content and become familiar with the material prior to delivering the lesson.

Create slides of the figures located at Attachments A.

Photocopy the handouts located at Attachments B and C for each cadet.

PRE-LESSON ASSIGNMENT

Nil.

APPROACH

An interactive lecture was chosen for this lesson to present basic information on model rocketry, and summarize the teaching points.

INTRODUCTION

REVIEW

Nil.

OBJECTIVES

By the end of this lesson the cadet shall be expected to describe the parts of a model rocket, the flight profile of a model rocket, and model rocket safety.

IMPORTANCE

It is important that the cadets know the parts of a model rocket, how a model rocket engine works, and model rocket safety, so they can plan the flight profile of their model rocket.

Teaching Point 1**Describe the parts of a model rocket engine.**

Time: 15 min

Method: Interactive Lecture

Model rocket engines are composed of six basic parts:

- engine case,
- clay nozzle,
- black powder propellant,
- delay composition,
- ejection charge, and
- igniter.



Show the cadets the slide of Figure A-1 located at Attachment A.

ENGINE CASE

The case keeps the engine together and under the correct pressure. Without pressure, the fuel will burn without producing efficient thrust. If the case is not strong enough and the pressure gets too high, the engine will explode. The engine case can be made of paper, cardboard, plastic or aluminum. Paper cases are rolled from paper to form a solid tube of cardboard.

CLAY NOZZLE

The nozzle directs the gas that is formed by the reaction of the oxidant out the back of the rocket. The nozzle is formed so the gasses are accelerated as they pass through the nozzle and provide efficient thrust. Nozzles can be made of clay, ceramic or metal.

PROPELLANT

The propellant is the substance that actually burns or oxidizes. This reaction between the oxidizer and fuel generates gas and heat, which provides the power for the rocket.

Model rocket engines use black powder as both the oxidizer and fuel. The black powder is mixed with other components and is packed or molded into a solid form inside the engine case. These engines are easy to use and safe to transport because the components do not require special containers and the engines are very unlikely to ignite accidentally.

The propellant burns at a prescribed rate and propels the rocket through the atmosphere. The propellant burns stronger at takeoff and has less force towards the end of the power stage. This can be represented in a time-to-thrust graph.



Show the cadets the slide of Figure A-2 located at Attachment A.

Average thrust is calculated by dividing the total impulse by the duration of the propellant burning.

Depending on the depth of the igniter hole, rocket engines can burn two different ways. Shallow holes in the propellant result in end burn where the propellant burns from one end to the other. Engines requiring more lift use deep holes in the propellant causing the fuel to burn quickly resulting in extra lift earlier on in the flight.



Show the cadets the slide of Figure A-3 located at Attachment A.

Model rocket engines are labelled with a three-part classification code (B6-4) that describes the performance parameters of the engine. This code must be understood in order to choose the proper engine for the model rocket. The first part of the engine code is a letter designating the motor's total impulse class (the "B" in B6-4). Engine size is determined by the amount of propellant and case size. As engine size increases, the letter in the engine code changes to the next letter of the alphabet, and the engine is twice as powerful as the previous letter (eg, A series engines have 1.26 to 2.5 Newton seconds of force and B series engines 2.5 to 5 Newton seconds of force). Total impulse is the total power the engine produces. Total impulse is a measure of the momentum change the engine can impart to the rocket, measured in Newton-seconds. An engine with greater total impulse can lift a rocket higher and faster, and can lift heavier rockets, than an engine with lower total impulse. The table below gives the total impulse ranges and typical rocket performance for each class.



Show the cadets the slide of Figure A-4 located at Attachment A.

THE DELAY COMPOSITION

After the propellant has burned entirely the delay composition starts burning to allow the rocket to coast to the highest point in the flight or the apogee. As the delay composition burns, it emits smoke, allowing tracking of the rocket in its flight. Delay composition burn times can vary from 3–10 seconds and are linked to the weight and size characteristics of the rocket. A heavy and slow rocket would require a shorter burn time, as it would not be moving through the air as fast as a smaller lighter rocket with the same code engine. It is important to calculate the delay as deployment of the parachute or streamer during high speed before or after apogee can result in destruction of the parachute or streamer.

EJECTION CHARGE

The parachute or streamer is deployed by the ejection charge. This black powder charge ignites immediately after the delay composition has completed burning. It pushes the parachute or streamer and nose cone out of the front of the rocket.

IGNITER

The igniter uses an electrically activated fuse to ignite the propellant. An electrical source supplies power to the control panel and control switch. Switching on the power at the control switch causes the igniter to burn, which ignites the propellant.

CONFIRMATION OF TEACHING POINT 1

QUESTIONS:

- Q1. The engine case of a model rocket engine can be made from what materials?
- Q2. Why does a model rocket require an ejection charge?
- Q3. How does an igniter work?

ANTICIPATED ANSWERS:

- A1. Paper, cardboard, plastic or aluminum.
- A2. To deploy the parachute or streamer.
- A3. Switching on the power at the control switch causes the igniter to burn, which ignites the propellant.

Teaching Point 2

Describe the parts of a model rocket.

Time: 10 min

Method: Interactive Lecture

A model rocket consists of the following parts:

- nose cone,
- body tube,
- fins,
- launch lug,
- engine stop,
- engine restraint,
- shock cord, and
- parachute.



Show the cadets the slide of Figure A-5 located at Attachment A.

NOSE CONE

The nose cone helps the rocket cut through the air during flight. It is important that the nose cone be aerodynamic to offer the least resistance when moving through the air. There are several different styles of nose cones, some for specific speeds. The nose cone is fitted to the body tube so that it can easily be ejected to deploy the parachute. It has an attachment point on one end for the shock cord and can be made from plastic, wood, Styrofoam™, fibreglass or carbon fibre.

BODY TUBE

All the parts of the rocket attach to or are contained within the body tube. The tube must be rigid to maintain its form during flight and can be made of cardboard, plastic, fibreglass or carbon fibre.

FINS

The fins help stabilize the rocket during flight. They are usually placed near the engine and are usually made of balsa wood, plastic, cardboard, fibreglass or carbon fibre. They must be attached securely and accurately to the body tube as any misalignment will result in an unpredictable flight. Fins on a rocket should be handled with care to avoid damage and misalignment.

LAUNCH LUG

The launch lug guides the rocket off the launch pad for the first metre of flight until the rocket has reached enough speed for the fins to stabilize the rocket. In order to launch the rocket the launch lug is placed on the launch rod of the tower. The lug slides the rocket down the launch rod and is held there until launch. When the launch button is pressed, the rocket engine accelerates the rocket up the launch rod guided by the lug and can quickly achieve over 50 km / h before it leaves the launch rod. The lug can be made of cardboard or metal.

ENGINE STOP

The engine stop prevents the engine from being pushed through the body tube by the engine's thrust. The engine stop is usually made of cardboard.

ENGINE RESTRAINT

The restraint keeps the engine from being ejected out the tail of the rocket by the parachute deploying an explosive charge. Restraints can be a metal strap, screws or strong tape.

Both the engine stop and restraint prevent the effects of Newton's third law: for every action there is an equal and opposite reaction.

SHOCK CORD

The ejection of the parachute must happen when the rocket reaches apogee or the highest point in the flight. The shock cord, made from elastic webbing, absorbs the force of the explosion that ejects the parachute. One end of the shock cord is attached to the nose cone, the other end to the body tube and the parachute is attached to the nose cone or the middle of the shock cord.

PARACHUTE

The descent of the rocket must be controlled to avoid damage to people, property or the rocket. There are several ways to slow the descent of the rocket. The most common is the parachute, which traps air in a canopy to slow the decent. Parachute canopies are made of light flexible sheet material, in the form of a cross or circle. Shroud lines are made of string or cord, with one end attached to the edges of the canopy and the other end of the shroud lines are attached together to the shock cord or nose cone. Parachute sizes and shroud line length are carefully calculated to control the descent. A large parachute will allow the wind to carry the rocket far from the launch tower. A parachute that is too small will cause the rocket to descend too quickly, possibly causing damage to the rocket.

Other forms of descent can be used on different rockets. Streamers can be used with lightweight rockets and act as a drag on the rocket. Free fall can only be used by the lightest rockets and has no additional equipment to slow the rocket. The drag from the rocket's body and fins will slow the rocket. Glide recovery involves attaching a wing to the rocket to allow the rocket to glide to the Earth.

CONFIRMATION OF TEACHING POINT 2

QUESTIONS:

- Q1. What purpose does the nose cone serve?
- Q2. What does the launch lug do?
- Q3. How do the fins affect the flight of the rocket?

ANTICIPATED ANSWERS:

- A1. It helps the rocket cut through the air.
- A2. It guides the rocket off the launch pad.
- A3. The fins stabilize the rocket during flight.

Teaching Point 3

Describe the flight profile of a model rocket.

Time: 10 min

Method: Interactive Lecture

The burn stages of a model rockets engine allow one to predict the flight profile of the rocket. The flight profile of a model rocket consists of six stages:

1. ignition,
2. power,
3. coast / delay,
4. ejection,
5. descent, and
6. landing.

IGNITION

Ignition is the result of an electrical current lighting from the control panel and launch switch. The actual device that starts the engine burning is the igniter. It looks like a match head with wires coming from the tip. When the electrical current passes through the igniter, it heats up, causing it to burst into flame. This flame is what actually starts the propellant burning in the rocket engine.



Show the cadets the slide of Figure A-6 located at Attachment A.

After ignition, the rocket will leave the launch tower under thrust. The launch tower guides the rocket during low speed to ensure the rocket remains aligned on the prescribed course. The stabilizer fins on the rocket take over as it leaves the launch rod on the tower, usually at around 50 km / h.



Show the cadets the slide of Figure A-7 located at Attachment A.

POWER

The propellant inside the engine burns quickly. In most engines, the propellant is consumed in less than three seconds, at which point burnout occurs. This means the engine is no longer producing a thrust force. By the time the engine burns out, the rocket has already reached its top speed and begins decelerating. While the rocket may reach hundreds of metres in the air, the burnout location on most rockets is about 15–25 m (50–80 feet) in the air.



Show the cadets the slide of Figure A-8 located at Attachment A.

COAST / DELAY

When the engine burns out, the rocket may be travelling hundreds of kilometres per hour. The parachute or streamer can be destroyed if it is ejected at this speed. The model will coast upward and lose airspeed as gravity and air friction slow it down. The period of time that starts at engine burnout and ends when the parachute is ejected out of the rocket is called the coast phase. The delay composition is now burning at a prescribed rate and produces smoke. The rocket moves so fast, that it is hard to follow visually and the smoke helps give a visual indication of the location of the rocket.



Show the cadets the slide of Figure A-9 located at Attachment A.

EJECTION

When the delay composition is done burning, the rocket should be at apogee. As the delay composition finishes burning it ignites the ejection charge. This ejection charge burns quickly, and is directed forward inside the rocket body tube. Its goal is to push off the nose cone, and eject the parachute out of the rocket. Ejection should occur right at apogee when the rocket has reached its slowest speed. Engine selection controls when the ejection charge pushes out the parachute. If the delay composition burns too long, the rocket will arc over, and will eject the chute while the rocket has begun accelerating in free fall descent. If the delay composition burns too quickly, the rocket may still be moving too fast as it has not coasted to its highest point. Ejection of the parachute at any point other than at apogee will result in the rocket and / or parachute being destroyed and the rocket free falling.



Show the cadets the slide of Figures A-10 and A-11 located at Attachment A.

DESCENT

After the parachute has ejected, it fully inflates, and the rocket begins its descent phase. The rocket drifts slowly to the ground under the canopy of the parachute or drag of the streamer. The wind will affect the descent of the rocket and this will result in the model drifting away from the launch pad. Descent should not be more than 4.5 m / s (15 feet per second) or it is possible to damage the rocket. If the descent is too slow, the rocket will drift farther from the launch pad affecting recovery.

LANDING

After landing, the rocket should be fully inspected before the next launch. The engine case should be discarded.



Show the cadets the slide of Figure A-12 located at Attachment A.

CONFIRMATION OF TEACHING POINT 3**QUESTIONS:**

- Q1. How is a model rocket tracked during its flight?
- Q2. When is the optimum time during a rocket's flight profile to deploy the parachute or streamer?
- Q3. Why is there a delay or coast phase during the rocket's flight?

ANTICIPATED ANSWERS:

- A1. The smoke emitted by the delay composition and parachute or streamer can track the flight of a rocket.
- A2. At apogee.
- A3. To allow the rocket to slow down enough to deploy the parachute without destroying it.

Teaching Point 4**Explain model rocketry safety rules.**

Time: 15 min

Method: Interactive Lecture

The hobby of model rocketry originated at the dawn of the space age in the late 1950s. Seeing space boosters carry the first artificial satellites into Earth's orbit inspired many enthusiastic young people to try to emulate the rocket pioneers by building their own rockets. Unfortunately, these homemade rockets involved stuffing flammable chemicals into metal pipes, very often with tragic results. Newspapers told stories of fingers and eyes lost and all too frequently of lives lost.

What was needed was a safe alternative that would allow young people to experience constructing and launching their own rockets and provide them with the opportunity to explore the science of rocketry.

Several companies developed engines that did not explode and provided a safe flight for model rockets. This style of engine is still in use today.

Safety is important when flying model rockets. It is impossible to get out of the way of a rocket going over 400 km / h. The flame produced by the engine is extremely hot and capable of inflicting serious burns or setting objects on fire. Therefore, there are rules in place for launching rockets. The Canadian Aviation Regulations (CARs) and the Canadian Association of Rocketry (CAR) have rules for launching model rockets.



Distribute photocopies of Attachments B and C to the cadets.

The CARs establish that a model rocket equipped with a model rocket engine will not have a total impulse exceeding 160 Newton-seconds and will not exceed 1500 grams, and will be equipped with a parachute or recovery device capable of retarding its descent. Anything above these parameters requires a high power model rocketry license and permission to fly from Transport Canada.

CAR model rocket rules cover launch site size, model rocket construction and launch procedures.

CONFIRMATION OF TEACHING POINT 4

QUESTIONS:

- Q1. Why is safety important when launching model rockets?
- Q2. Who establishes the rules for model rocketry in Canada?
- Q3. What is the maximum weight of a model rocket?

ANTICIPATED ANSWERS:

- A1. There are potential dangers from the rocket engine's flame and the high velocity of the rocket.
- A2. Canadian Association of Rocketry.
- A3. 1500 grams.

END OF LESSON CONFIRMATION

QUESTIONS:

- Q1. When do the fins help guide the rocket during its flight?
- Q2. How are rocket engines classified?
- Q3. How do we slow a rocket's descent?
- Q4. What purpose does the nose cone serve?
- Q5. What is apogee?

ANTICIPATED ANSWERS:

- A1. When the rocket achieves over 50 km / h or when it leaves the launch rod.
- A2. By letter, each successive letter doubles the force of the engine.
- A3. By using a parachute or streamer.
- A4. It helps the rocket cut through the air.
- A5. The highest point of a flight.

CONCLUSION

HOMEWORK / READING / PRACTICE

Nil.

METHOD OF EVALUATION

Nil.

CLOSING STATEMENT

Model rocketry is a fun and exciting sport. It is important to know the parts of a model rocket, how a model rocket engine works, model rocket safety, and how to plan the flight profile of a model rocket, to be able to fly model rockets safely.

INSTRUCTOR NOTES / REMARKS

Cadets who have completed Advanced Aerospace summer training may assist with this instruction.

Cadets who are qualified Advanced Aviation may assist with this instruction.

REFERENCES

C3-162 Beach, T. (1993). *Model rocketry technical manual*. Retrieved October 10, 2007, from <http://www.estesrockets.com/assets/downloads/roeketrytechniques.pdf>

C3-163 Cannon, R. L. (1999). *A learning guide for model rocket launch systems*. Retrieved October 10, 2007, from <http://www.estesrockets.com/assets/downloads/launchsystemguide.pdf>

C3-259 ISBN 978-0471472421 Stine, G. H. (2004). *Handbook of model rocketry*. Toronto, ON: John Wiley & Sons.

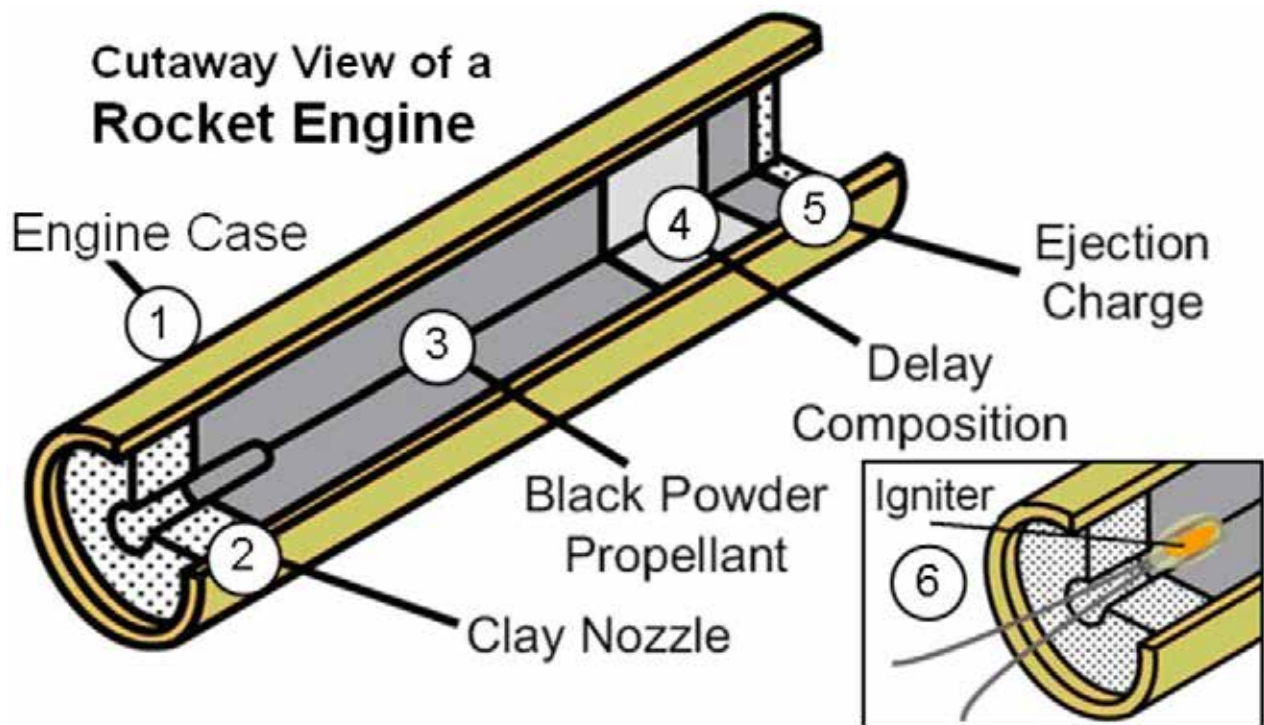

Figure A-1 Cutaway View of a Rocket Engine

Note. From "Apogee Peak of Flight Newsletter", 2003, *How Black Powder Rocket Motors Work*. Retrieved November 16, 2007, from <http://www.apogeerockets.com/educator/downloads/newsletter114.pdf>

TIME/THRUST CURVES

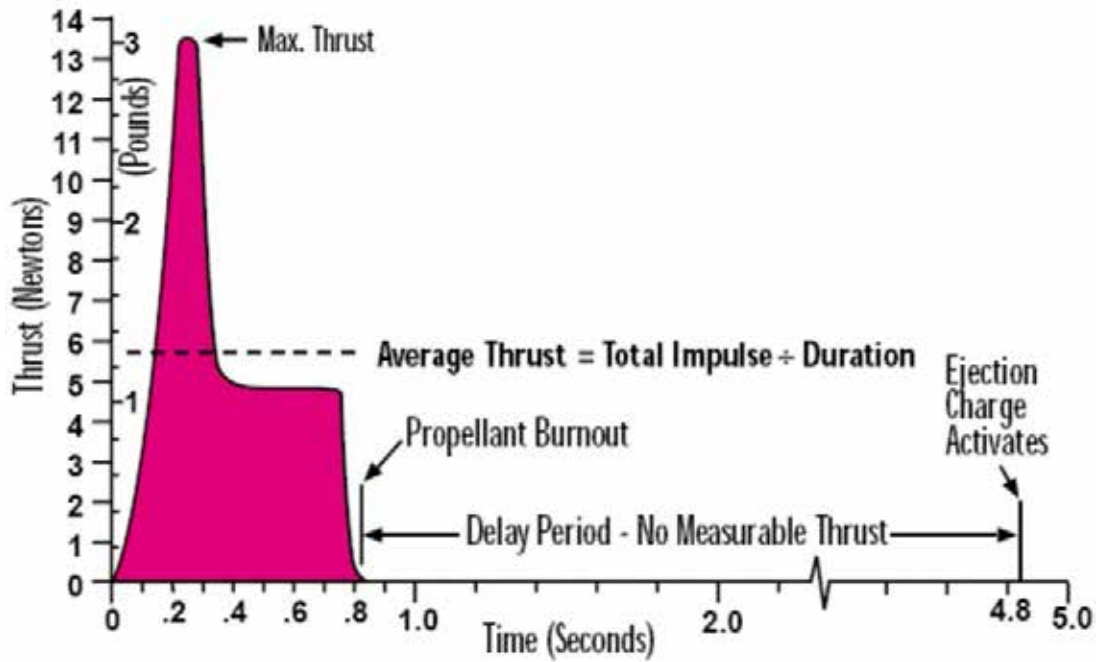

Figure A-2 Time / Thrust Curves

Note. From "Estes Rocketry", 1993, by T. Beach, 2003, *Model Rocketry Technical Manual*. Retrieved October 10, 2007, from <http://www.estesrockets.com/assets/downloads/rocketrytechniques.pdf>

ENGINE CODING FOR QUICK-N-EASY IDENTIFICATION

1. Label color indicates recommended use of the engine.
 - a. Green Single Stage rockets
 - b. Purple Upper Stage or Single Stage, if used in very light rockets
 - c. Red *Booster and intermediate stages of multi-stage rockets
 - d. Black *Special plugged engines for R/C gliders

*These contain no delay or ejection charge.
2. Code designation stamped on the engine gives useful and important information on its performance capabilities.
 - a. This portion indicates total impulse or total power produced by the engine.
 - b. This portion shows the engine's average thrust in Newtons and helps you choose the proper engine for your rocket's flight.
 - c. This number gives you the delay in seconds between burnout and ejection charge. It lets you choose the engine with the delay time you want for any flight.

TYPE AND PRIMARY USE

B6-2 SINGLE STAGE



Figure A-3 Model Rocket Engine Codes

Note. From "Estes Rocketry", 1993, by T. Beach, 2003, *Model Rocketry Technical Manual*. Retrieved October 10, 2007, from <http://www.estesrockets.com/assets/downloads/rocketrytechniques.pdf>

TOTAL IMPULSE CLASSIFICATION

Code	Pound-Seconds	Newton-Seconds
1/2A	0.14 - 0.28	0.625 - 1.25
A	0.28 - 0.56	1.26 - 2.50
B	0.56 - 1.12	2.51 - 5.00
C	1.12 - 2.24	5.01 - 10.00
D	2.24 - 5.00	10.01 - 20.00

Figure A-4 Impulse Classification for Model Rocket Engines

Note. From "Estes Rocketry", 1993, by T. Beach, 2003, *Model Rocketry Technical Manual*. Retrieved October 10, 2007, from <http://www.estesrockets.com/assets/downloads/roeketrytechniques.pdf>

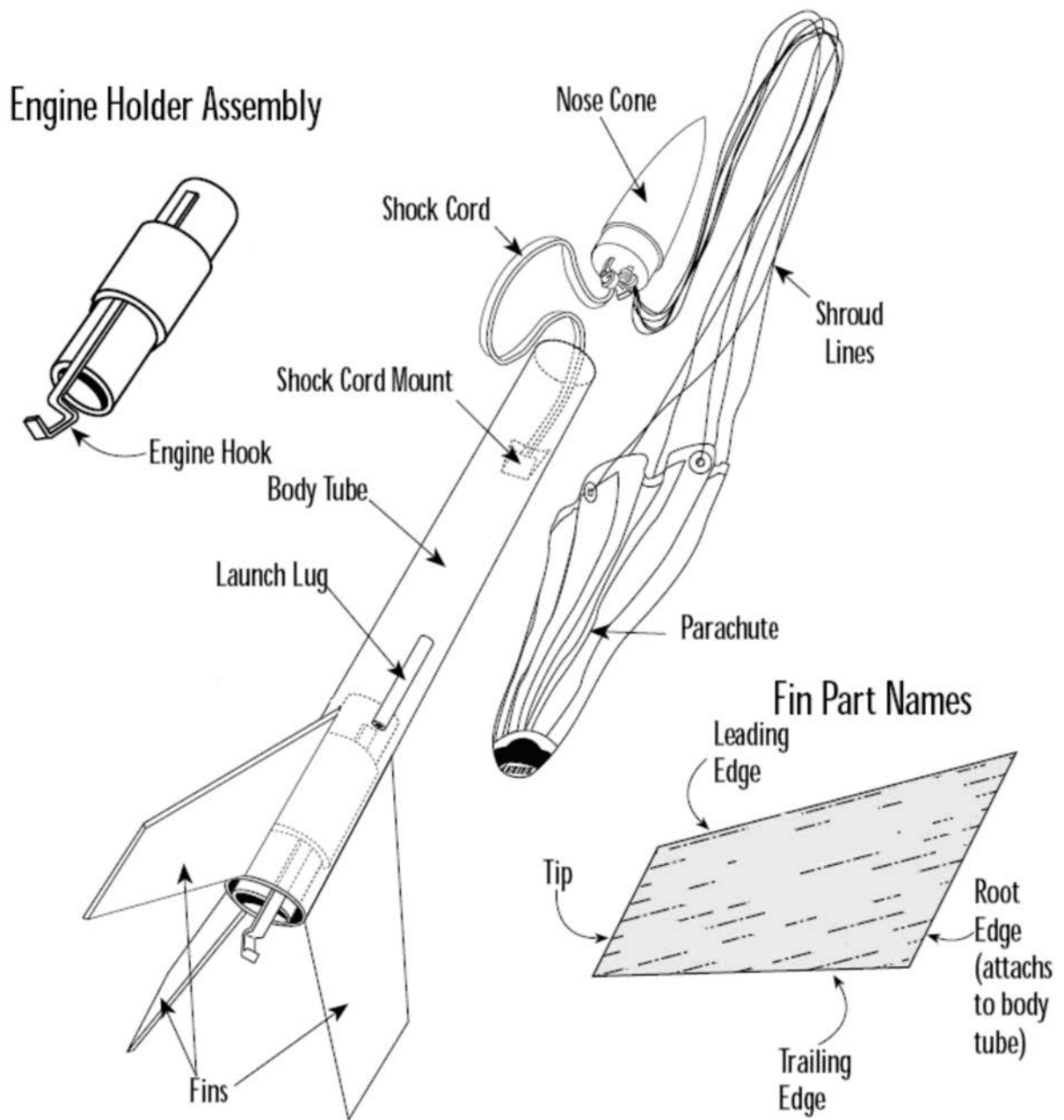

Figure A-5 Parts of a Model Rocket

Note. From "Estes Rocketry", 1993, by T. Beach, 2003, *Model Rocketry Technical Manual*. Retrieved October 10, 2007, from <http://www.estesrockets.com/assets/downloads/rocketrytechniques.pdf>

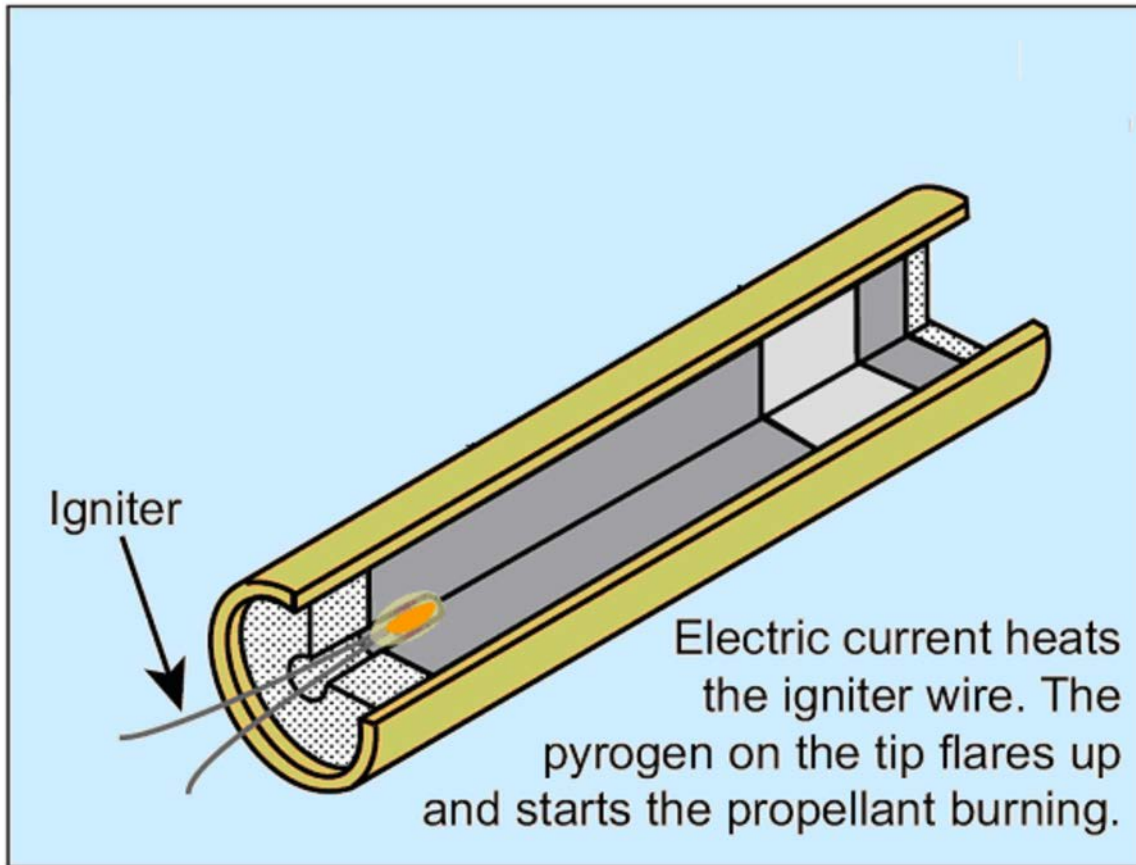

Figure A-6 The Igniter

Note. From "Apogee Peak of Flight Newsletter", 2003, *How Black Powder Rocket Motors Work*. Retrieved November 16, 2007, from <http://www.apogeerockets.com/educator/downloads/newsletter114.pdf>

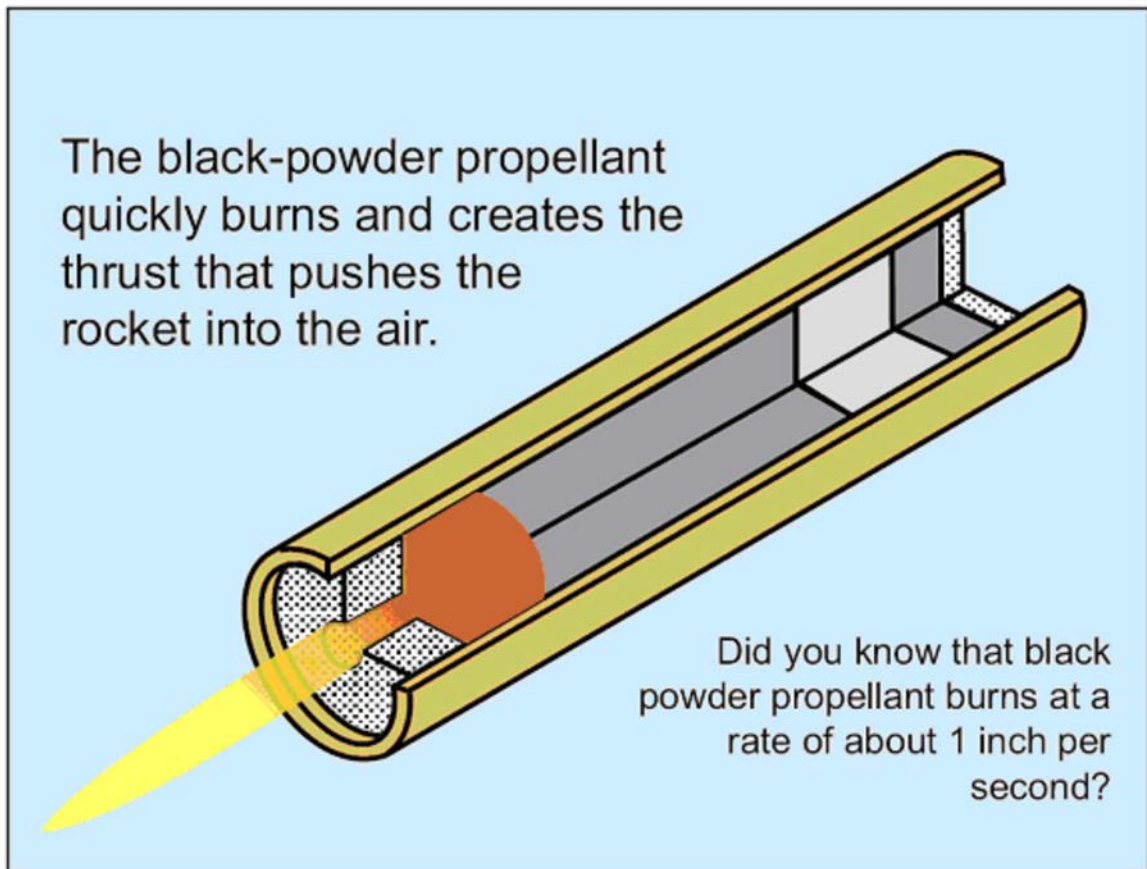

Figure A-7 The Propellant Ignited

Note. From "Apogee Peak of Flight Newsletter", 2003, *How Black Powder Rocket Motors Work*. Retrieved November 16, 2007, from <http://www.apogeerockets.com/educator/downloads/newsletter114.pdf>

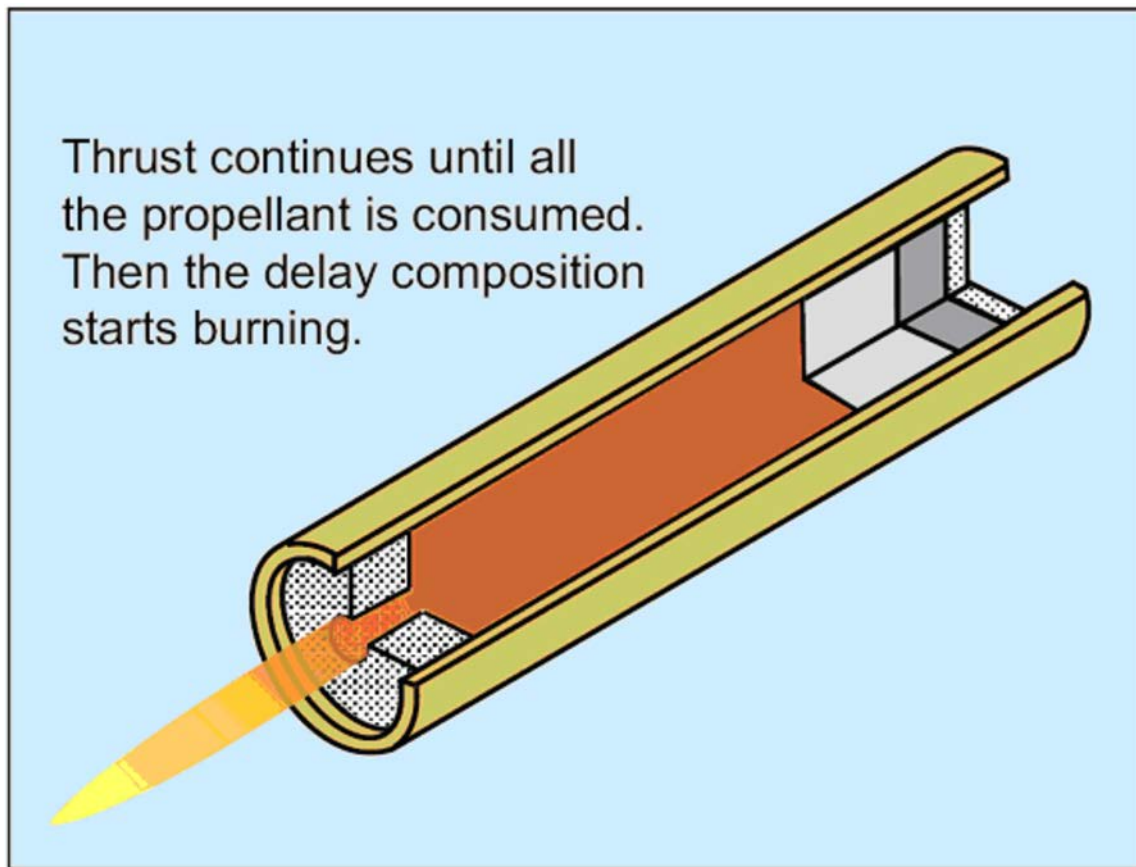

Figure A-8 Thrust Phase

Note. From "Apogee Peak of Flight Newsletter", 2003, *How Black Powder Rocket Motors Work*. Retrieved November 16, 2007, from <http://www.apogeerockets.com/educator/downloads/newsletter114.pdf>

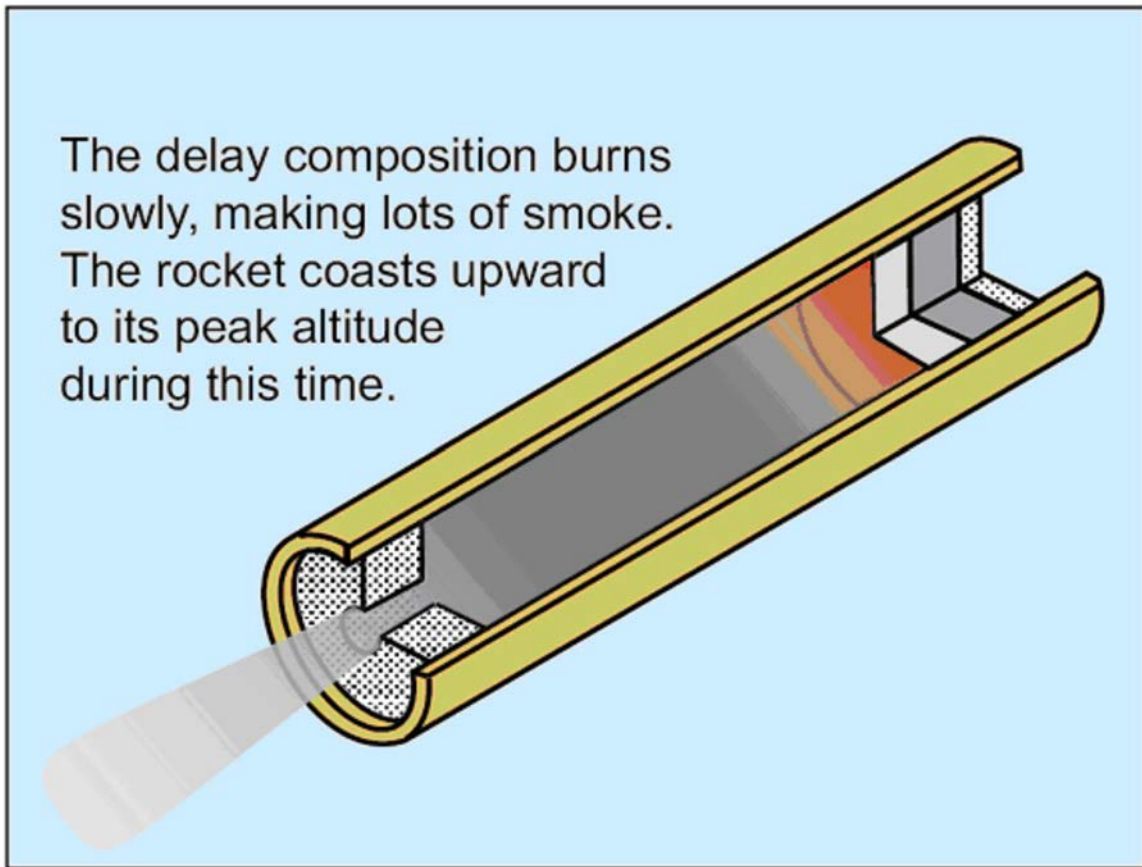

Figure A-9 Delay or Coast Phase

Note. From "Apogee Peak of Flight Newsletter", 2003, *How Black Powder Rocket Motors Work*. Retrieved November 16, 2007, from <http://www.apogeerockets.com/educator/downloads/newsletter114.pdf>

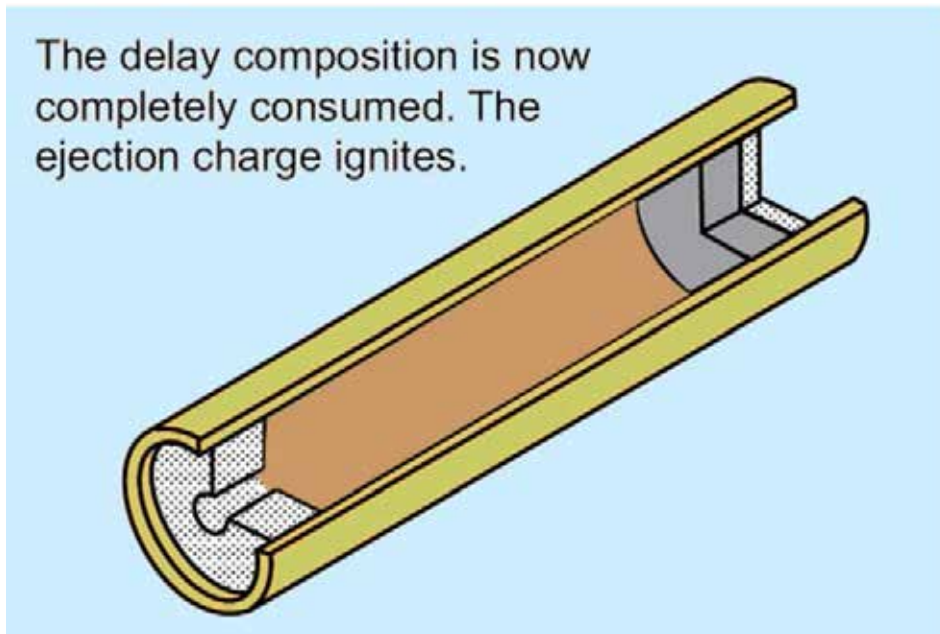

Figure A-10 Beginning of the Ejection Phase

Note. From "Apogee Peak of Flight Newsletter", 2003, *How Black Powder Rocket Motors Work*. Retrieved November 16, 2007, from <http://www.apogeerockets.com/educator/downloads/newsletter114.pdf>

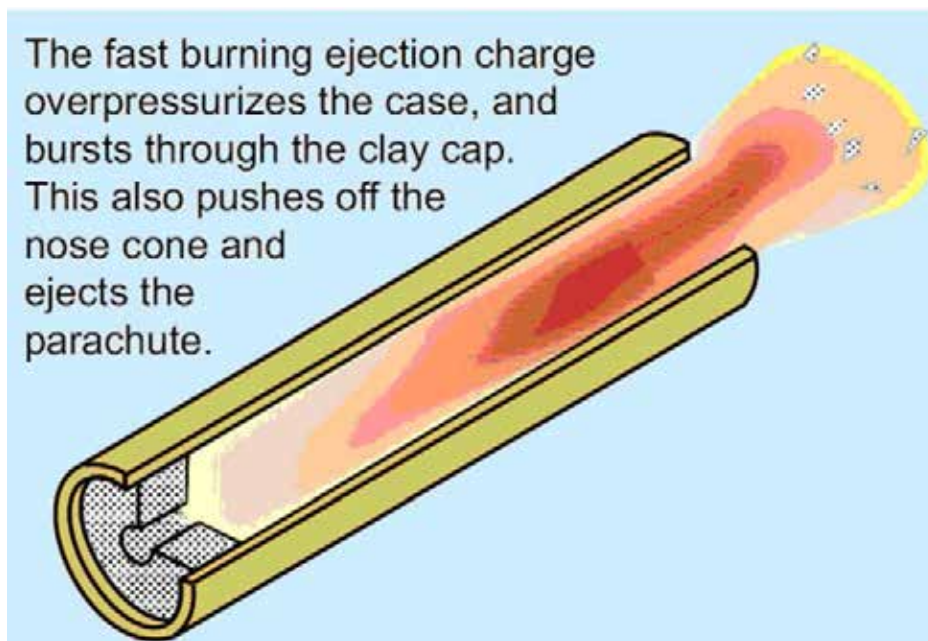

Figure A-11 Ejection Phase

Note. From "Apogee Peak of Flight Newsletter", 2003, *How Black Powder Rocket Motors Work*. Retrieved November 16, 2007, from <http://www.apogeerockets.com/educator/downloads/newsletter114.pdf>

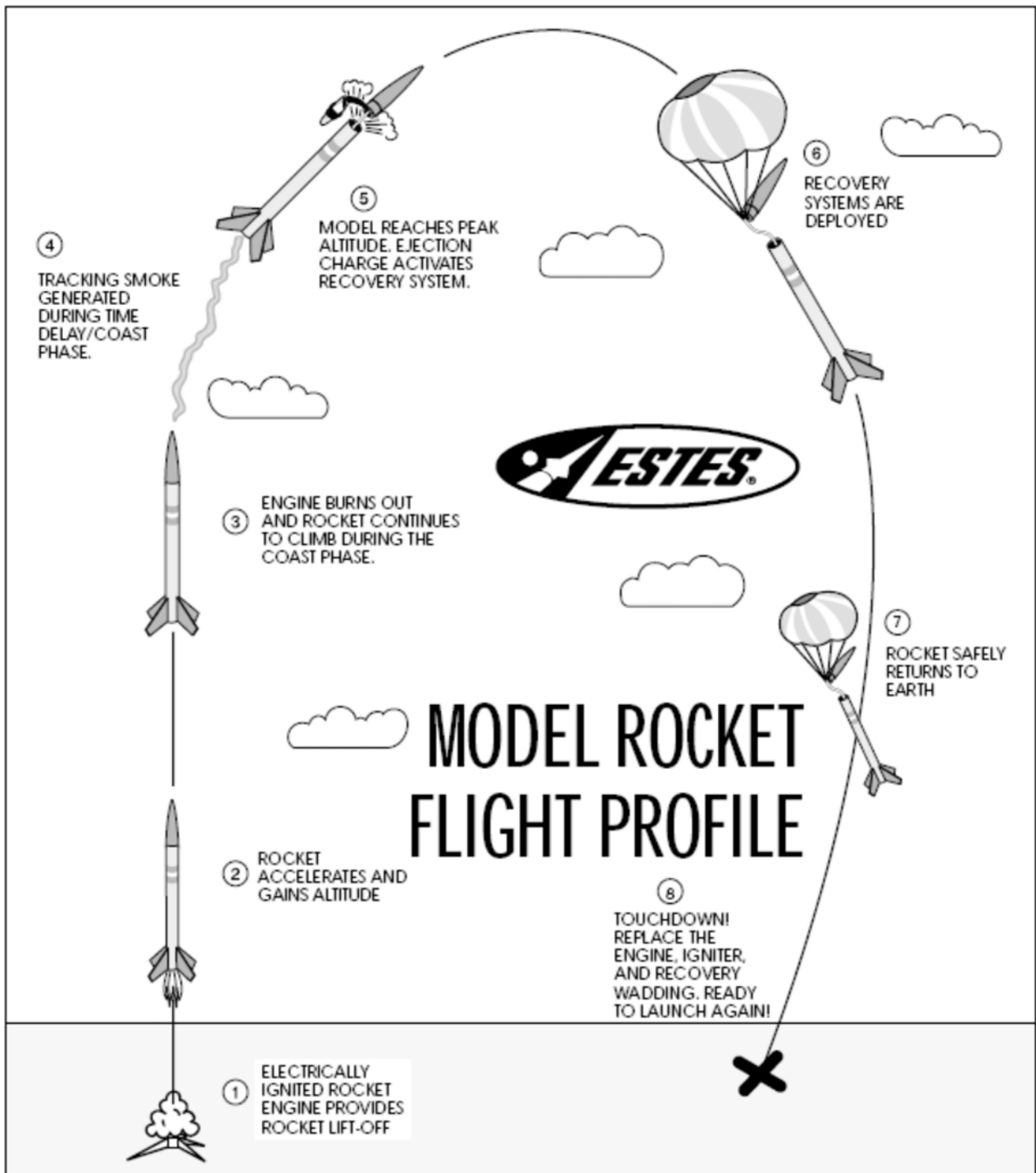

Figure A-12 Model Rocket Flight Profile

Note. From "Estes Rocketry", 1993, by T. Beach, 2003, *Model Rocketry Technical Manual*. Retrieved October 10, 2007, from <http://www.estesrockets.com/assets/downloads/rocketrytechniques.pdf>

THIS PAGE INTENTIONALLY LEFT BLANK

CANADIAN ASSOCIATION OF ROCKETRY: CANADA MODEL ROCKET SAFETY CODE

1. **CONSTRUCTION:** I will always build my model rocket using only lightweight materials such as paper, wood, plastics and rubber without any metal airframe components. My model shall include aerodynamic surfaces or a mechanism to assure a safe, stable flight.
2. **ENGINES:** I will use only pre-loaded, commercially available model rocket engines approved safe by Energy, Mines and Resources Canada. I will never subject these engines to excessive shock, extremes of temperature, nor will I ever attempt their reloading or alteration. I shall always employ recommended manufacturer handling and ignition procedures.
3. **RECOVERY:** My model rocket will always utilize a recovery system to return it safely to the ground so that my model rocket may be reflown. I shall prepare the recovery system with due care to assure that it will properly deploy.
4. **WEIGHT LIMITS:** My model rocket will not weigh more than 1500 grams at liftoff and the model rocket engine(s) will contain no more than 125 grams of propellant.
5. **FIRING SYSTEM:** I will always use a remote, electrical system to ignite the model rocket engine(s). My firing system will include an ignition switch that will return to "OFF" when released, and a safety interlock key switch to prevent accidental ignition. I will never leave the safety interlock key in my firing system between launches.
6. **LAUNCH SYSTEM:** My model rocket will always be launched from a stable platform having a device to initially guide its motion. My launch system will have a jet deflector to prevent the engine exhaust from directly contacting the ground, or inflammable launcher components. To protect others and myself from eye injury, I will position the launch rod or rail so that the upper end is above eye level, or else I will place a large guard on the upper end between launches. I will never place my body or hand directly over my loaded model rocket mounted on the launch system.
7. **LAUNCH SITE:** I will never launch my model rocket near buildings, power lines or within 9.1 kilometres from the centre of an airport. The area immediately around the launch system will be cleared of any flammable materials. I will always obtain the permission of the launch site owner prior to using the launch site for my model rocket activities.
8. **LAUNCH CONDITIONS:** I will never launch my model rocket in high winds or under conditions of low visibility that may impair the observation of my model rocket in flight, or in a direction below 30 degrees from the vertical.
9. **LAUNCH SAFETY:** I will remain at least five metres away from any model rocket about to be launched. I will always announce to persons within the launch site that I am about to launch my model rocket, and I shall give a loud countdown of at least five seconds duration. I shall immediately remove the safety interlock key from my firing system after the launch of my model rocket.
10. **MISFIRE:** In the event of an ignition misfire, I shall not immediately approach my model rocket, but remove the safety interlock key and remain back for a safe period until assured that no ignition will occur.
11. **ANIMAL PAYLOADS:** I will never endanger live animals by launching them in my model rocket.
12. **TARGETS:** I will never launch my model rocket so that it will fall on or strike ground or air targets, nor will I include any explosive or incendiary payload.
13. **HAZARDOUS RECOVERY:** I will never attempt to recover my model rocket from a power line, high place or other dangerous location.

14. PRE-FLIGHT TESTS: Whenever possible, I will, always test the stability, operation and reliability of my model rocket designs prior to flight. I will launch unproven designs in complete isolation from other persons.
15. PERSONAL CONDUCT: I will always conduct myself in a responsible manner, conscious that the maintenance of safety for others and myself rests with my ability to design and construct sound, working models, and to enthusiastically abide by the Canada Model rocket Safety Code.

2. CANADIAN ASSOCIATION OF ROCKETRY: MODEL ROCKET STANDARDS
 - 2.1 A "model rocket" is defined as a heavier-than-air flying rocket having a substantially non-metallic airframe, employing the reaction force of a model rocket engine as its sole source of lift and incorporating an automatically initiated system that will assure a safe descent and model reusability.
 - 2.2 The model rocket shall be constructed of wood, paper, plastic or similar lightweight materials. No substantial metal components shall be incorporated in the model rocket airframe.
 - 2.3 The model rocket shall embody aerodynamic surfaces and / or a guidance system, which will develop the necessary stabilizing and restoring forces to produce and maintain a safe, predictable and substantially vertical flight path. Model rockets, which employ an internally or externally controlled guidance system, shall incorporate sufficient inherent stability to fail safe any malfunction or disabling of the guidance system.
 - 2.4 The model rocket shall incorporate a reliable and effective means, of retarding its descent so that no hazard shall be presented to 'persons or property on the ground, and to prevent model damage upon touchdown so as to enable reflight. All engine casings and / or portions of the model jettisoned from the model rocket during flight shall descend with a fully deployed streamer or parachute, or by aerodynamic surfaces, which will induce rapid tumbling or a shallow glide. Minimum loading requirements shall be five (5) square centimetres per gram for parachutes, and ten (10) square centimetres per gram for streamers.
 - 2.5 A model rocket shall utilize no more than three powered stages. A "powered stage" shall be defined as a unit of the whole model rocket airframe which contains one or more model rocket engines, and which is designed to and / or actually separates as a unit in flight after the burnout of its contained engine(s). The number of powered stages used shall be assessed from the staged model configuration at the instant of its first motion on the launcher.
 - 2.6 A model rocket incorporating a self-energized firing system shall contain a safety interlock switch that will disable the firing circuit when "OFF". Activation of the firing system shall occur only immediately prior to launch. The self-energized firing system shall include a safe and reliable provision to test circuit continuity.
 - 2.7 All combustible materials subject to high temperature developed by the function of any model rocket engine, burning-wick dethermalizer or other auxiliary devices operating at higher than 200 degrees Celsius shall be flame proofed or similarly protected to prevent their ignition. Any on-board device, which initiates ignition and / or employs combustion, shall be self-extinguishing upon termination of actual or intended function.
 - 2.8 A model rocket shall never contain an explosive or pyrotechnic payload, nor shall it be used to launch a living animal.
 - 2.9 The maximum or gross mass of a model rocket at launch shall not exceed 1500 grams.
 - 2.10 The model rocket shall contain no more than 125 grams of propellant grain.

THIS PAGE INTENTIONALLY LEFT BLANK



**ROYAL CANADIAN AIR CADETS
PROFICIENCY LEVEL FOUR
INSTRUCTIONAL GUIDE**



SECTION 4

EO C440.02 – LAUNCH A SMALL MODEL ROCKET

Total Time:	90 min
-------------	--------

PREPARATION

PRE-LESSON INSTRUCTIONS

Resources needed for the delivery of this lesson are listed in the lesson specification located in A-CR-CCP-804/PG-001, *Proficiency Level Four Qualification Standard and Plan*, Chapter 4. Specific uses for said resources are identified throughout the instructional guide within the TP for which they are required.

Review the lesson content and become familiar with the material prior to delivering the lesson.

Locate a proposed launch site IAW the Launch Site Set-Up located at Attachment A.

Ensure that permission to launch a small model rocket has been received from airport authorities.

Ensure that written permission to use the launch location has been received from the property owner.

Perform a risk assessment of the launch location.

Practice rocket engine and igniter installation.

Assemble the rocket launch controllers and launch towers.

PRE-LESSON ASSIGNMENT

Nil.

APPROACH

A practical activity was chosen for this lesson as it is an interactive way to introduce the cadets to constructing and launching model rockets in a safe, controlled environment.

INTRODUCTION

REVIEW

Nil.

OBJECTIVES

By the end of this lesson, the cadet shall have launched a small model rocket.

IMPORTANCE

It is important for cadets to experience the thrill of launching a model rocket, as it will stimulate an interest in aerospace, model rocketry and the Air Cadet Program. Launching a small model rocket that they built themselves will also develop in cadets a sense of pride and accomplishment.

Teaching Point 1**Demonstrate and have the cadets assemble a model rocket.**

Time: 25 min

Method: Practical Activity

ACTIVITY**OBJECTIVE**

The objective of this activity is to have the cadets assemble a model rocket.

RESOURCES

- No. 11 hobby knives,
- Cement for plastic models,
- Scissors,
- Pencil, and
- Model rocket kit that utilizes an A-series engine.

ACTIVITY LAYOUT

Nil.

ACTIVITY INSTRUCTIONS

1. Familiarize the cadets with the parts of the rocket.
2. Distribute one model rocket kit to each cadet.
3. Demonstrate and have the cadets, in pairs, complete the steps in building a model rocket.

SAFETY

- Caution is required when using sharp tools.
- Provide adequate ventilation when using solvent-based glues.

CONFIRMATION OF TEACHING POINT 1

The cadets' participation in the activity will be the confirmation of this TP.

Teaching Point 2**Have the cadets assist in the set-up of the rocket launch site.**

Time: 20 min

Method: Practical Activity



Have the cadets assist in the set-up of the rocket launch site IAW Attachment A.

CONFIRMATION OF TEACHING POINT 2

The cadets' participation in the activity will serve as the confirmation of this TP.

Teaching Point 3

Have the cadet launch a small model rocket.

Time: 35 min

Method: Practical Activity

ACTIVITY

OBJECTIVE

The objective of this activity is to have the cadets launch the small model rockets assembled in TP 1.

RESOURCES

- Preassembled model rockets from TP 1,
- Rocket launch site setup drawing located at Attachment A,
- Model rocket launching procedure located at Attachment B,
- Model rocket launch tower,
- Model rocket launch controller,
- 80 m of safety tape,
- 18 modular tent pegs or a suitable substitute,
- Safety glasses,
- Voltmeter,
- Pliers,
- Screwdriver, and
- Electrical tape.

ACTIVITY LAYOUT

The rocket launch site will be set up IAW Attachment A.

ACTIVITY INSTRUCTIONS

1. Follow the model rocket launching procedure located at Attachment B.
2. Have the cadets install the igniters in the rocket engines.
3. Have the cadets install the rocket engines in the rockets.
4. Have the cadets place the rockets on the launch pads.
5. Have the cadets press the launch buttons and launch their rockets.

6. Have the cadets track the rockets through its flight.
7. After the rockets have landed, have the cadets recover them.

SAFETY

- Ensure control of the entire rocket site at all times.
 - Only the instructor and the cadets launching the rockets will be in the launch control area.
 - Spectators will remain at least 20 m from the launch tower.
 - Engines should be kept in a steel box and only distributed when the rockets are ready to be launched.
 - Horseplay will not be tolerated at any time during the launching of model rockets.
 - Recovery should be done quickly as delay may prevent the launching of all the rockets.
-

CONFIRMATION OF TEACHING POINT 3

The cadets' participation in the activity will serve as the confirmation of this TP.

END OF LESSON CONFIRMATION

The cadets' participation in the small model rocket launch will serve as the confirmation of this lesson.

CONCLUSION

HOMEWORK / READING / PRACTICE

Nil.

METHOD OF EVALUATION

Nil.

CLOSING STATEMENT

A model rocket is subject to the same forces and laws of nature as a space-program launch vehicle. Experience with model rockets will give the hobbyist useful space program insights.

INSTRUCTOR NOTES / REMARKS

EO C440.01 (Describe Model Rocketry) must also be selected and delivered prior to this lesson.

Cadets who are qualified Advanced Aerospace may assist with this instruction.

REFERENCES

C3-162 Beach, T. (1993). *Model rocketry technical manual*. Retrieved October 10, 2007, from <http://www.estesrockets.com/assets/downloads/roeketrytechniques.pdf>

C3-163 Cannon, R. L. (1999). *A learning guide for model rocket launch systems*. Retrieved October 10, 2007, from <http://www.estesrockets.com/assets/downloads/launchsystemguide.pdf>

C3-259 ISBN 978-0-471-47242-1 Stine, G. H. (2004). *Handbook of model rocketry*. Toronto, ON: John Wiley & Sons.

LAUNCH SITE SET-UP

1. A safety briefing will be held before the launch site is set up, covering the following points:
 - a. The Launch Control Officer (LCO) is the only person permitted to activate the launch control panel.
 - b. All launch systems will be placed in "safe" mode between each flight.
 - c. When a rocket is descending out of control, launch site personnel will point at the rocket and repeat the phrase "heads up" until the rocket has landed.
 - d. No horseplay will be tolerated.
 - e. A safe rendezvous point will be clearly indicated and in the event of an emergency, launch site staff will move all cadets and staff to this point.
 - f. The area required for launching model rockets should be at least 100 m square. It should not have any tall buildings, trees, power lines or other tall objects close by. The cadets and spectators should be located in an area at least 20 m from the launch towers. Bleachers at a baseball field or soccer field are suitable.
 - g. If the site is within 9 km (5.6 miles) from an aerodrome, the aerodrome must be advised of the date and time the rockets will be launched. The rocket can reach a height of 200–400 feet at apogee and can be flown safely from the suggested field size.
2. Wind will play an important factor in the rocket's recovery. The descending rocket will drift with the wind and if descending too slowly will land far from the launch site. Rockets should not be launched in winds stronger than 35 km / h (28 miles per hour).



If the first rockets launched descend too slowly resulting in the rockets landing far from the launch site, a hole can be cut in the centre of the parachute to speed up the rockets descent.

3. Layout the rocket launch site as per Figure A-1. Wind direction should be accounted for by placing the towers closer to the windward side of the field.
4. Using modular tent pegs or a suitable substitute as posts, cordon off a 10 m by 10 m security tape border around the launch towers and a 10 m by 10 m security tape border around the launch control site leaving a 1 m opening for access.
5. Assemble the launch towers as per directions included with the towers. Place the launch towers in a line perpendicular to the wind. The launch rods should point slightly into the wind.
6. Place the launch control panels on the launch control tables and run the wire from each of the launch control boxes to the launch towers ensuring the wires are not tangled and in good working order.
7. All rockets will be brought to the rocket holding area before the launch begins.
8. Make sure all the connections are clean and tight.

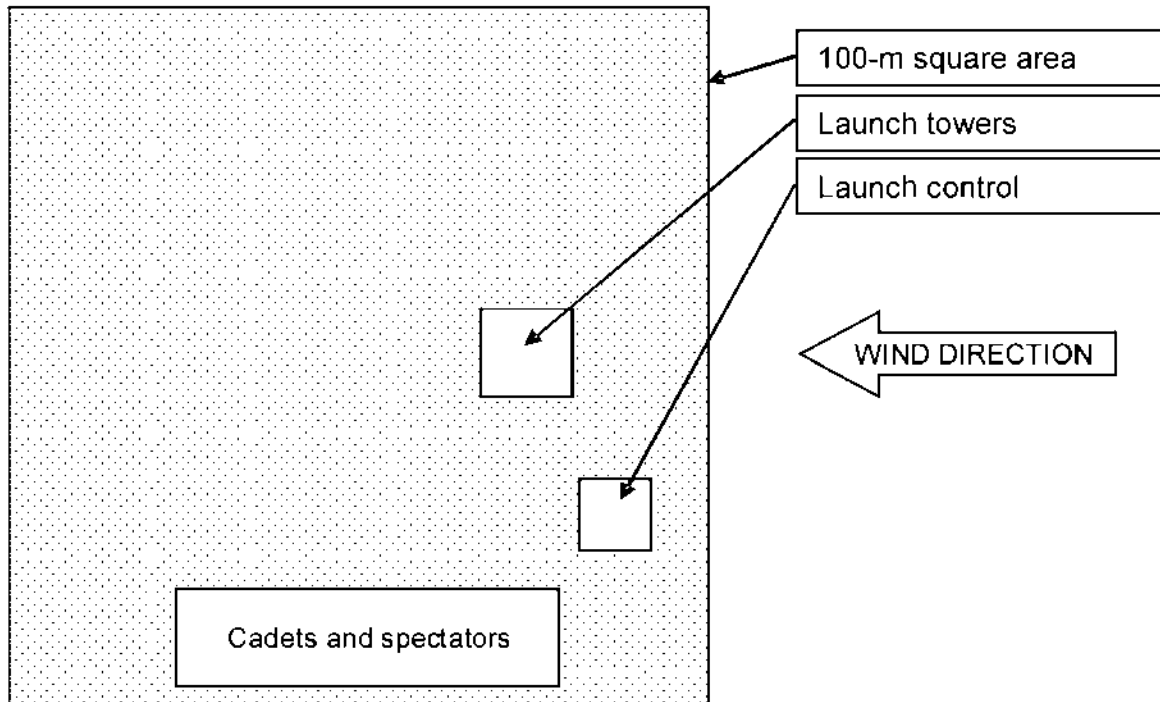

Figure A-1 Layout for a Rocket Launch Site

Note. Created by Director Cadets 3, 2008, Ottawa, ON: Department of National Defence.

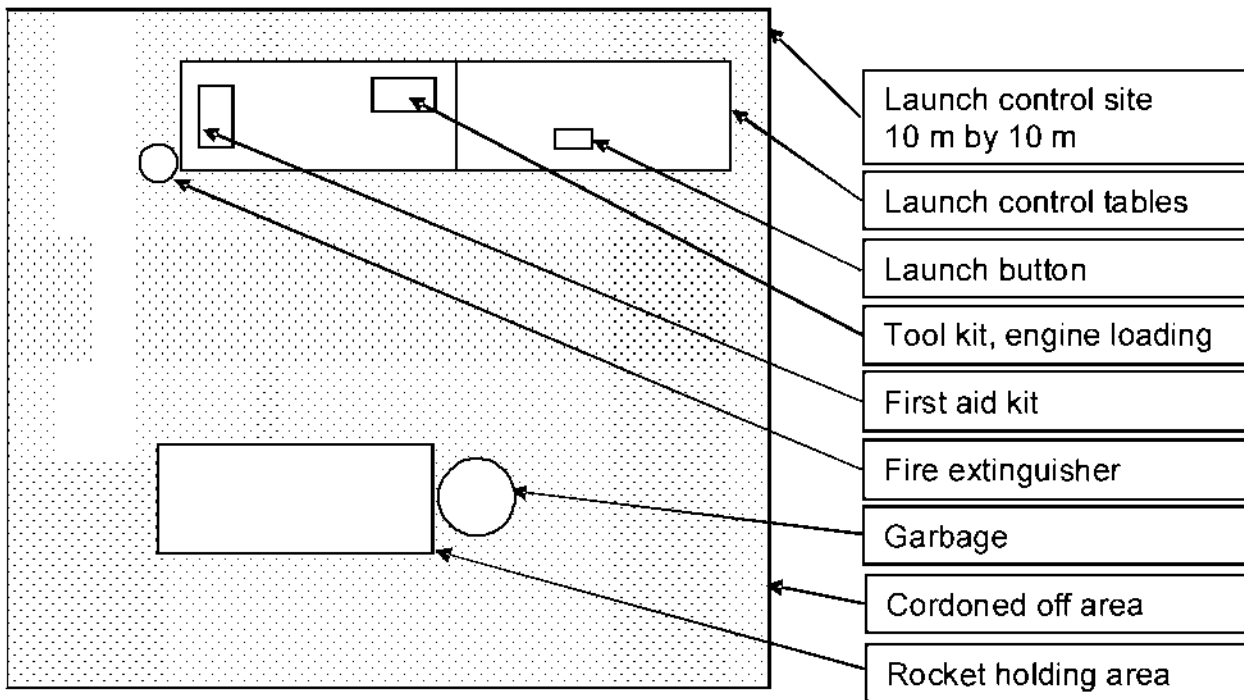

Figure A-2 Layout for a Launch Control

Note. Created by Director Cadets 3, 2008, Ottawa, ON: Department of National Defence.

MODEL ROCKET LAUNCH PROCEDURE

1. Place the launch control switches in the safe position.
2. Collect the rockets from the cadets and prepare them for launch by following the directions included with the model rocket, launch control and launch towers.



The igniters should be handled with care, as damaged igniters are the cause of most misfires.

3. Following the launch tower directions, install one rocket on each launch tower.
4. Verify the launch control switches are in the safe position.
5. Connect the two alligator clips from each launch controller to the igniter leads on each of the rockets.
6. Make sure everyone stands back from the launch towers and have the cadets start a countdown from ten, backwards to zero.
7. Place the safe switches in the launch position.
8. Have the cadets press the launch buttons and launch their rockets.



If the rocket does not lift off the pad, wait at least one minute before approaching the pad. See Attachment C for troubleshooting the launch system.

9. Have the cadets track the rockets through their flights.
10. After the rockets have landed, allow the cadets to recover them.



After each flight, the alligator clips at the launch towers should be cleaned with 280-grit sandpaper and replaced when they can no longer be cleaned effectively.

THIS PAGE INTENTIONALLY LEFT BLANK

IF THE ROCKET ENGINE DOES NOT IGNITE

1. Place the launch control button in the safe mode.
2. Wait one minute before approaching the launch tower. This will ensure the engine is no longer able to ignite.
3. Undo the alligator clips from the igniter and remove the rocket from the launch tower.
4. At the launch tower, test the power with a voltmeter to ensure there is voltage present by setting the voltmeter to "V" and placing the tower's alligator clips on the leads of the voltmeter, red to red and black to black.
5. With all the wires connected and the launch button pressed, the launch control lights should be on and the voltmeter should read approximately the voltage of the combined batteries (eg, three batteries at 1.5 volts each equals 4.5 volts).
6. If the lights on the launch control do not light or the voltmeter registers low voltage or no voltage at all, the batteries are weak or dead, one of the wires is broken, or there is a loose connection at the launch control or the launch pad.
7. To trace the problem, start at the launch control and ensure there are fresh batteries. If the batteries are fresh and correctly installed, proceed to the launch tower and verify if there is voltage at the launch tower. Repair any breaks in the wire or loose connections.
8. Verify that the igniter leads are not touching each other and that the igniter tip is not broken. If the igniter appears to be unserviceable, install a new igniter and restart the launch process.

THIS PAGE INTENTIONALLY LEFT BLANK



**ROYAL CANADIAN AIR CADETS
PROFICIENCY LEVEL FOUR
INSTRUCTIONAL GUIDE**



SECTION 5

EO C440.03 – DISCUSS CHARACTERISTICS OF THE PLANETS IN THE SOLAR SYSTEM

Total Time:	60 min
-------------	--------

PREPARATION

PRE-LESSON INSTRUCTIONS

Resources needed for the delivery of this lesson are listed in the lesson specification located in A-CR-CCP-804/PG-001, *Proficiency Level Four Qualification Standard and Plan*, Chapter 4. Specific uses for said resources are identified throughout the instructional guide within the TP for which they are required.

Review the lesson content and become familiar with the material prior to delivering the lesson.

Photocopy the Planets Specifications Sheet located at Attachment A for each cadet.

Create slides of Attachment B to be used in the end of lesson confirmation.

PRE-LESSON ASSIGNMENT

Nil.

APPROACH

An interactive lecture was chosen for this lesson to introduce the cadets to the characteristics of the planets in the solar system and to generate interest in the subject.

INTRODUCTION

REVIEW

Nil.

OBJECTIVES

By the end of this lesson the cadet shall have discussed the characteristics of the planets in the solar system.

IMPORTANCE

It is important for cadets to know the characteristics of the planets in our solar system as space exploration continues to develop. The exploration of the solar system is long term and will span many generations. Cadets who are familiar with the solar system may be able to contribute to this exploration.



Distribute to each cadet a copy of the Planet Specifications Sheet located at Attachment A to be completed as the information is presented during the lesson.

Teaching Point 1

Discuss the planet Mercury.

Time: 5 min

Method: Interactive Lecture

MERCURY

The planet Mercury, named for the Roman messenger god, is the closest planet to the sun. It is the smallest planet and a cratered wasteland. Since it is so close to the sun it means the planet is completely at the mercy of solar radiation, solar flares, and other solar weather phenomena. The planet is also battered by the many asteroids that float through space. The sun's gravitational pull means that these free floating bodies of rock accelerate towards the sun. Depending on Mercury's position in orbit, these asteroids may impact its surface. There are craters on Mercury that are 600 km wide. Our knowledge of this planet is still incomplete. Only one man-made satellite has ever passed by Mercury, and it was able to collect information about only a small portion of the planet's surface.

Mean Distance From the Sun

Mercury is the closest planet to the sun. The range varies from 46 million to 69.8 million km. The mean distance is 57.9 million km.

Size

Mercury's diameter is a mere 4 879 km. The planet's diameter is only 0.383 times that of Earth.

Mass

Mercury is the smallest planet in our solar system. Its mass is 0.0553 times the mass of Earth.

Rotation

Despite the quick pace that the planet travels around the sun, Mercury does not rotate around its own axis very quickly. It takes 58.65 days for the planet to rotate around its axis, or two-thirds of a Mercurian year.

Inclination

The axis of Mercury sits at an angle of 0.01 degrees relative to the sun's axis.

Orbit Characteristics

Mercury has what is known as an eccentric orbit. This means that the distance the planet is from the sun varies throughout its revolution around the sun. The actual shape that the planet would travel around the sun would be an ellipse. This can be seen in the extreme range in the planet's distance from the sun. Mercury travels around the sun once every 88 days. This means that the Mercurian year is 88 days long. Mercury's synodic period is 115.9 days.



Synodic period. The time it takes for a planet to return to a specific spot in the night sky as observed from Earth.

Mercury has an average orbital velocity of 47.9 km / s. This means that the planet travels in its orbit around the sun at an average speed of 47.9 km / s or 172 440 km / h.

CONFIRMATION OF TEACHING POINT 1

The cadets' completion of Mercury's specification box on the Planet Specification Sheet will serve as the confirmation of this TP.

Teaching Point 2

Discuss the planet Venus.

Time: 5 min

Method: Interactive Lecture

VENUS

Travelling from the sun past Mercury, the next planet is Venus. Named for the Roman goddess of love and beauty, Venus is constantly cloaked in cloud. This permanent cover means that scientists know very little about the surface of the planet. Observed from Earth, Venus is the brightest planet in the night sky. The Space Age has greatly enhanced our understanding of this planet. Prior to the 1960s, it was thought that Venus was an oceanic planet equivalent in vegetation to Earth during pre-historic periods. Since the 1960s, several satellites have been sent to Venus or on a path near Venus. These satellites have included Mariner 2 and 10, and the Russian Venera 7, 9, and 13 landings.

Mean Distance From the Sun

Venus is the second closest planet to the sun at a mean distance of 108.2 million km. The distance can range from 107.5 million to 108.9 million km.

Size

Venus is very similar in size to Earth. Many scientists refer to Venus and Earth as near-twins. The diameter of the planet at the equator is 12 104 km, approximately 0.949 times that of Earth.

Mass

The mass of Venus is approximately 0.815 times the mass of Earth.

Rotation

Venus is unique in that it is the only planet in our solar system which rotates east to west, or clockwise. All other planets, including Earth, rotate west to east or counter-clockwise. It takes just over 243 days for Venus to rotate around its axis. It should be noted that this is longer than the Venusian year.

Inclination

The axis of Venus sits at an angle of 177.4 degrees. This means that the planets north pole is actually at the bottom of the planet.

Orbit Characteristics

Venus' orbit around the sun is almost perfectly circular which explains the small range of distance from the sun. It takes 224.7 days for Venus to complete one revolution around the sun. This means that one year on Venus is 224.7 days long. Venus' synodic period is 583.92 days, meaning that the planet will return to the same point in the Earth's sky almost every two years. Venus has an orbital velocity of 35.02 km / s or 126 072 km / h.

CONFIRMATION OF TEACHING POINT 2

The cadets' completion of Venus' specification box on the Planet Specification Sheet will serve as the confirmation of this TP.

Teaching Point 3

Discuss the planet Earth.

Time: 10 min

Method: Interactive Lecture

EARTH

The Earth is the third planet from the sun and is the only planet known to support life. The Earth's atmosphere is composed mainly of nitrogen and oxygen. The temperatures are moderate, due to the ozone layer found in our atmosphere. There is water on Earth, which in current scientific belief is an absolute requirement for life.

Earth has one naturally occurring satellite, Luna. Usually, Luna is simply referred to as the moon. The moon has a profound effect on Earth. Not only is it a constant feature in the night sky, but being the brightest object means that it can provide light on a clear night. Being so close to the Earth (384 000 km) and with a diameter of 3 475 km, the moon also has a gravitational effect on our planet. This effect is most apparent in the tidal patterns of our oceans.

Distance From the Sun

The Earth's average distance from the sun is 149.6 million km. Due to the orbit this can range from 147.1 million to 152.1 million km.

Size

Since humans have studied the Earth in depth, we tend to base all of our concepts of planet size relative to the Earth. Earth is therefore the standard by which we measure the size of other planets. Earth's diameter is 12 756 km at the equator.

Mass

Earth's mass is 5.97×10^{21} tonnes. Earth's ratio values for both size and mass are one, since we use the Earth as the standard for measurement.

Rotation

The Earth rotates west to east around its axis. It takes 23h 56m 04s for the Earth to complete one rotation. This means that the standard Earth day is approximately 24 hours in length.

Inclination

Earth's axis is tilted at an angle of 23.5 degrees.

Orbit Characteristics

The Earth's orbit is very circular as seen by the small range in distance from the sun. It takes 365.2 days for the Earth to revolve once around the sun. As such, our standard year is 365 days in length with a leap year every four years to take into account the 0.2 days. The Earth has an orbital velocity of 29.8 km / s or 107 280 km / h.

CONFIRMATION OF TEACHING POINT 3

The cadets' completion of Earth's specification box on the Planet Specification Sheet will serve as the confirmation of this TP.

Teaching Point 4**Discuss the planet Mars.**

Time: 5 min

Method: Interactive Lecture

MARS

Mars is the fourth planet from the sun. Named after the Roman god of war due to its red colour, there are many legends that claim this planet was bright in the sky on the eve of many great victories. Mars has taken a central place in many of today's space programs. At its closest, Mars is 59 million km away from Earth, making it the second-closest planet after Venus. During the space race of the 1960s, the goal was to be the first to set foot on the moon. Now, there is a collaborative effort by many international space agencies to send a manned mission to Mars. The planet itself is currently deemed uninhabitable without the use of artificial environment resources. There have been many probes sent to Mars in recent years to assess the natural environment and evaluate what equipment would be needed in order to sustain human life on the planet.

Mean Distance From the Sun

Mars is nearly twice the Earth's distance from the sun. The mean distance the planet is from the sun is 227.9 million km. This ranges from 206.6 million to 249.2 million km depending on its position in its orbit around the sun.

Size

The diameter of Mars at the equator is 6 792 km, which is 0.532 times that of Earth.

Mass

The mass of Mars is 0.107 times that of Earth.

Rotation

Like Earth, Mars' rotation is west to east and takes 24h 39m 35s. In other words, a standard Earth day is very close in duration to a Martian day.

Inclination

The axis of Mars is also very similar to Earth's. The axis of Mars is tilted at an angle of 25.2 degrees.

Orbit Characteristics

The orbit of Mars is eccentric, as shown by the large range in distance from the sun. Mars will revolve around the sun once every 687 days (a little less than two years). Mars has an orbital velocity of 24.1 km / s or 86 760 km / h.

CONFIRMATION OF TEACHING POINT 4

The cadets' completion of Mars' specification box on the Planet Specification Sheet will serve as the confirmation of this TP.

Teaching Point 5**Discuss the planet Jupiter.**

Time: 10 min

Method: Interactive Lecture

JUPITER

After passing through the ring of the asteroid belt, the next planet past Mars is Jupiter, the innermost gas giant planet. Named after the leader of the Roman gods (Zeus to the Greeks), Jupiter is the largest planet in our solar system. Despite its distance from the Earth, the only planets that can outshine it in the night sky are Earth's neighbours, Venus and Mars.

Jupiter has 63 known natural satellites. Of these, 47 are less than 10 km in diameter, and only 4 are large enough to be considered moons. These are identified as Galilean moons and include:

- Io is in orbit 421 600 km from the centre of Jupiter and takes 1.7 days to orbit the planet. The dimensions of Io are not exactly spherical, measuring 3 660 km by 3 637 km by 3 631 km.
- Europa is in orbit 670 900 km from the centre of Jupiter. It takes 3.5 days for the moon to orbit the planet once. Europa is 3 130 km in diameter.
- Ganymede is in orbit 1 070 000 km from the centre of Jupiter and it takes 7.2 days to complete one full orbit of the planet. Ganymede is 5 268 km in diameter.
- Callisto is in orbit 1 880 000 km from the centre of Jupiter and orbits once every 16.7 days. Callisto is 4 806 km in diameter.

Mean Distance From the Sun

Though Jupiter is the fifth planet in our solar system, the separation provided by the asteroid belt means that Jupiter is a great distance from the sun. The mean distance of Jupiter from the sun is 778.4 million km. Due to its orbit this distance can range from 740.5 million to 816.6 million km.

Size

The diameter of Jupiter at its equator is 142 984 km, 11.21 times that of Earth. Due to the rotation of Jupiter, there is a significant difference between the diameter at the equator and the diameter at the poles. The polar diameter is 133 700 km, almost 10 000 km less than the equatorial diameter. By comparison, the difference in diameter between the Earth's equator and poles is a mere 42 km.

Mass

Jupiter's mass is 317.8 times the mass of Earth.

Rotation

Jupiter rotates at an immense speed which causes the equator to bulge out. This is the reason for the large difference between the equatorial and polar diameters. One day on Jupiter is only 9h 55m 30s.

Inclination

Jupiter's axis is only 3.1 degrees from the perpendicular, meaning that Jupiter is almost straight up and down.

Orbit Characteristics

Jupiter has a slightly eccentric orbit. Due to its distance from the sun, it takes the planet 4 331 days (11.86 years) to revolve around the sun. The orbital velocity of Jupiter is 13.1 km / s or 47 160 km / h. Jupiter's synodic period is 398.9 days.

CONFIRMATION OF TEACHING POINT 5

The cadets' completion of Jupiter's specification box on the Planet Specification Sheet will serve as the confirmation of this TP.

Teaching Point 6**Discuss the planet Saturn.**

Time: 5 min

Method: Interactive Lecture

SATURN

Saturn is a very distinct planet in our solar system. It is the second of the gas giants from the sun, the sixth planet in the system. Named after the Roman god of time because of the length of time it takes for the planet to cross the night sky, Saturn is said to be the most beautiful object in the sky when viewed through a telescope.

Mean Distance From the Sun

Saturn is more remote than Jupiter. Orbiting at a mean distance of 1 433.5 million km, Saturn is almost twice as far from the sun as Jupiter.

Size

Saturn's equatorial diameter is 120 536 km, which is more than nine times that of the Earth. Saturn is the second largest planet in the solar system.

Mass

Saturn's mass is 95.2 times the mass of Earth.

Rotation

Saturn rotates on its axis once every 10h 13m 59s. Like Jupiter, the speed at which this occurs causes a slight bulging at the equator, causing the large distortion between the equatorial diameter and the polar diameter.

Inclination

The axis of Saturn tilts at an angle of 26.7 degrees.

Orbit Characteristics

Saturn has a slightly eccentric orbital path. It travels around the sun in 10 747 days or 29.43 years. Saturn's synodic period is 378.1 days. The orbital velocity of Saturn is 9.7 km / s or 34 920 km / h.

CONFIRMATION OF TEACHING POINT 6

The cadets' completion of Saturn's specification box on the Planet Specification Sheet will serve as the confirmation of this TP.

Teaching Point 7**Discuss the planet Uranus.**

Time: 5 min

Method: Interactive Lecture

URANUS

Uranus is a very distinct planet which shares some of the characteristics of Saturn. Most prominent of these are the rings which orbit the planet, but even here there is uniqueness. Uranus is barely visible to the naked eye and the study of Uranus actually led to the discovery of the next planet in the solar system. The planet is named after the mythological father of Saturn.

Mean Distance From the Sun

Uranus is the second-furthest planet from the sun. The mean distance is 2 872.5 million km with a maximum of 3 003.6 million km and a minimum of 2 741.3 million km. Compared to Saturn, Uranus is twice as far from the sun and four times as far as Jupiter.

Size

Uranus is just over one third the size of Jupiter, but is still the third largest planet in the solar system. It has an equatorial diameter of 51 118 km, which is 4.01 times that of Earth.

Mass

Uranus' mass is 14.5 times that of Earth.

Rotation

Uranus rotates around its axis once every 17h 14m.

Inclination

The axis of Uranus tilts at an angle of 97.8 degrees. This means that it is technically on its side and the rings of Uranus look like they are vertical compared to Saturn's rings. Also, the satellites orbit Uranus on a vertical plane instead of a horizontal plane like the other planets.

Orbit Characteristics

Uranus has an irregular orbit. There is a point in the orbit where Uranus, as viewed from Earth, performs two 180-degree turns. This would look like a giant Z in the orbital path. It takes Uranus 83.76 years to orbit the sun once. Its mean orbit velocity is 24 607 km / h. The synodic period of Uranus is 369.7 days.

CONFIRMATION OF TEACHING POINT 7

The cadets' completion of Uranus' specification box on the Planet Specification Sheet will serve as the confirmation of this TP.

Teaching Point 8**Discuss the planet Neptune.**

Time: 5 min

Method: Interactive Lecture

NEPTUNE

Named after the Roman god of the sea, Neptune was found as a result of scientific study of Uranus. Almost all of our knowledge of Neptune comes from one spacecraft, Voyager 2, which flew past the planet in 1989. The

atmosphere is made up predominantly of hydrogen, helium and methane. The planet is a very windy place, with equatorial winds in excess of 450 m / s or 1 620 km / h.

Mean Distance From the Sun

Neptune is approximately half again as far as Uranus from the sun. Orbiting at a mean distance of 4 495.1 million km, it is 20 times as far as Mars. Neptune is the last planet in the solar system, keeping in mind that Pluto has been down-graded to a dwarf-planet.

Size

Neptune is nearly identical in diameter to Uranus at 49 528 km, 3.88 times the diameter of the Earth.

Mass

Neptune's mass is more than 18 percent greater than Uranus' and 17.1 times the mass of the Earth.

Rotation

It takes Neptune 16h 7m to rotate once around its axis. This is the third fastest rotation of all of the planets.

Inclination

The tilt of Neptune's axis is 28.3 degrees, slightly more than Earth's.

Orbit Characteristics

Neptune's orbit is almost perfectly circular. It takes Neptune 163.7 years to orbit the sun, almost twice as long as Uranus. Its mean orbit velocity is 19 720 km / h. Neptune's synodic period is 367.5 days.

CONFIRMATION OF TEACHING POINT 8

The cadets' completion of Neptune's specification box on the Planet Specification Sheet will serve as the confirmation of this TP.

END OF LESSON CONFIRMATION

Show the cadets the slides of Attachment B and have them correct their own notes on the *Planet Specifications Sheet* located at Attachment A, which they completed during the lesson.

CONCLUSION

HOMEWORK / READING / PRACTICE

Nil.

METHOD OF EVALUATION

Nil.

CLOSING STATEMENT

The planets are more than just individual bodies floating in space. They are part of a large system and in some cases they are the centre of their own sub-system. Understanding the scale of this system is very important to understanding space exploration. With the mission to Mars moving in to the forefront of space news, we need to realize that this is not a small project, but one that could take years because of the distance and equipment

required. In addition, understanding the scale of the solar system and the scale location of the nearest star gives us a taste of the vastness of the universe and the importance of astronomy in our lives.

INSTRUCTOR NOTES / REMARKS

Planetary data is provided in detail at <http://solarsystem.nasa.gov/planets/index.cfm>

Cadets who are qualified Advanced Aerospace may assist with this instruction.

REFERENCES

C3-170 Ottewell, G. The National Optical Observatory. (1998). *Thousand-yard model: Or Earth as a peppercorn*. Retrieved October 16, 2007, from <http://noao.edu/education/peppercorn/pcmain.html>

C3-288 Williams, D. NASA. (2008). *Planetary fact sheet – metric*. Retrieved October 14, 2008, from <http://nssdc.gsfc.nasa.gov/planetary/factsheet/index.html>

C3-289 Williams, D. NASA. (2008). *Planetary fact sheet – ratio to earth values*. Retrieved October 14, 2008, from http://nssdc.gsfc.nasa.gov/planetary/factsheet/planet_table_ratio.html

PLANET SPECIFICATIONS SHEET

Mercury

Distance from the sun: _____ million km. Size: _____ km.

Mass _____ Earth Mass

Axis - Time of rotation: _____ Axis - Inclination: _____ degrees

Orbit: _____ days Orbit speed _____ km / h.

Venus

Distance from the sun: _____ million km. Size: _____ km.

Mass _____ Earth Mass

Axis - Time of rotation: _____ Axis - Inclination: _____ degrees

Orbit: _____ days Orbit speed _____ km / h.

Earth

Distance from the sun: _____ million km. Size: _____ km.

Mass _____ Earth Mass

Axis - Time of rotation: _____ Axis - Inclination: _____ degrees

Orbit: _____ days Orbit speed _____ km / h.

Mars

Distance from the sun: _____ million km. Size: _____ km.

Mass _____ Earth Mass

Axis - Time of rotation: _____ Axis - Inclination: _____ degrees

Orbit: _____ days Orbit speed _____ km / h.

Jupiter

Distance from the sun: _____ million km. Size: _____ km.

Mass _____ Earth Mass

Axis - Time of rotation: _____ Axis - Inclination: _____ degrees

Orbit: _____ days Orbit speed _____ km / h.

Saturn

Distance from the sun: _____ million km. Size: _____ km.

Mass _____ Earth Mass

Axis - Time of rotation: _____ Axis - Inclination: _____ degrees

Orbit: _____ days Orbit speed _____ km / h.

Uranus

Distance from the sun: _____ million km. Size: _____ km.

Mass _____ Earth Mass

Axis - Time of rotation: _____ Axis - Inclination: _____ degrees

Orbit: _____ days Orbit speed _____ km / h.

Neptune

Distance from the sun: _____ million km. Size: _____ km.

Mass _____ Earth Mass

Axis - Time of rotation: _____ Axis - Inclination: _____ degrees

Orbit: _____ days Orbit speed _____ km / h.

PLANET SPECIFICATIONS ANSWER KEY

Mercury

Distance from the sun: 57.9 million km Size: 4 879 km

Mass 0.0553 Earth masses

Axis - Time of rotation: 58.65 d Axis - Inclination: 0.01 degrees

Orbit: 88 days Orbit speed 172 440 km / h.

Venus

Distance from the sun: 108.2 million km Size: 12 104 km

Mass 0.815 Earth masses

Axis - Time of rotation: 243 d Axis - Inclination: 177.4 degrees

Orbit: 224.7 days Orbit speed 126 072 km / h.

Earth

Distance from the sun: 149.6 million km Size: 12 756 km

Mass: 1 Earth masses.

Axis - Time of rotation: 23h 56m 4s Axis - Inclination: 23.5 degrees

Orbit: 365.2 days Orbit speed 107 280 km / h.

Mars

Distance from the sun: 227.9 million km Size: 6 792 km

Mass: 0.107 Earth-masses

Axis - Time of rotation: 24h 37m 23s Axis - Inclination: 25.2 degrees

Orbit: 687 days Orbit speed 86 760 km / h.

Jupiter

Distance from the sun: 778.6 million km Size: 143 984 km

Mass 317.8 Earth-masses

Axis - Time of rotation: 9h 55m 30s Axis - Inclination: 3.1 degrees

Orbit: 11.86 years Orbit speed 47 160 km / h.

Saturn

Distance from the sun: 1 433.5 million km Size: 120 536 km

Mass 95.2 Earth masses

Axis - Time of rotation: 10h 13m 59s Axis - Inclination: 26.7 degrees

Orbit: 29.43 years Orbit speed 34 920 km / h.

Uranus

Distance from the sun: 2 872.5 million km Size: 51 118 km

Mass 14.5 Earth masses

Axis - Time of rotation: 17h 14m Axis - Inclination: 97.8 degrees

Orbit: 83.76 years Orbit speed 24 607 km / h.

Neptune

Distance from the sun: 4 495.1 million km Size: 49 528 km

Mass 17.1 Earth masses

Axis - Time of rotation: 16h 7m Axis - Inclination: 28.3 degrees

Orbit: 163.7 years Orbit speed 19 720 km / h.



ROYAL CANADIAN AIR CADETS
PROFICIENCY LEVEL FOUR
INSTRUCTIONAL GUIDE



SECTION 6

EO C440.04 – APPLY THE MATERIAL SCIENCE OF TRUSSES

Total Time:	90 min
-------------	--------

PREPARATION

PRE-LESSON INSTRUCTIONS

Resources needed for the delivery of this lesson are listed in the lesson specification located in A-CR-CCP-804/PG-001, *Proficiency Level Four Qualification Standard and Plan*, Chapter 4. Specific uses for said resources are identified throughout the instructional guide within the TP for which they are required.

Review the lesson content and become familiar with the material prior to delivering the lesson.

Create slides of Attachments A and B.

For each pair of cadets, construct one suspended container mount (SCM), described at Attachment C, for use in TP 3.

Photocopy the handouts at Attachment C for each pair of cadets.

Obtain one lightweight container for suspension from the SCM, such as a sandwich bag and wire, for incrementally adding marbles when testing the strength of trusses.

PRE-LESSON ASSIGNMENT

Nil.

APPROACH

An interactive lecture was chosen for TP 1 to generate interest in the material science of trusses and summarize the teaching point.

A practical activity was chosen for TPs 2 and 3 as it is an interactive way to allow the cadets to design and test a truss in a safe and controlled environment.

INTRODUCTION

REVIEW

Nil.

OBJECTIVES

By the end of this lesson the cadet shall have applied the material science of trusses by constructing and testing a truss.

IMPORTANCE

It is important for cadets to apply the material science of trusses as they are a common aerospace structural component due to their light weight and strength.

Teaching Point 1**Explain the material science of trusses.**

Time: 15 min

Method: Interactive Lecture

Successful structures must withstand the loads and forces that act upon them. When a load (external force), such as gravity or a person's weight, is applied to a structure, forces are produced within the structure (internal forces) to resist the load. Provided the internal forces equal the external forces, the structure will retain its integrity. When imbalances of internal and external forces occur, a structure may suffer a catastrophic failure.

TYPES OF LOADS

The two most significant forces on structures are compression and tension. In order for a structure to resist static and dynamic loads, it must be engineered appropriately.

Static loads. Loads that remain constant. The weight of the materials from which a structure is made exerts an internal static force on the structure. Gravity is a static load.

Dynamic loads. Loads that exert constantly changing forces upon a structure. A car crossing a bridge exerts external dynamic forces on the bridge that must be counteracted by internal forces within the bridge. The structure of the International Space Station (ISS) must resist bending and twisting when it is moved by docking spacecraft or the Canadarm 2.

PROPERTIES OF MATERIALS

Elastic. Material is considered elastic when it is capable of sustaining deformation without permanent loss of size or shape. Almost all materials have some elastic properties. Glasses and crystals tend to be the least elastic solids whereas organic substances such as rubber and wood tend to show considerable elasticity. Some metals, especially some alloys of iron, can be very elastic.



Show the cadets Figure A-1 located at Attachment A.

Plastic. If a substance is compressed or stretched beyond a certain limit (called its elastic limit) it begins to exhibit plastic-like properties and it will become permanently deformed. Once a material is stretched or compressed beyond its elastic limit it is said to enter a plastic phase.



Show the cadets Figure A-2 located at Attachment A.



The word "plastic" in this case refers to the physical properties of the material, NOT the substance(s) we call "plastic"—which is the common term for a wide range of synthetic or semisynthetic organic solid materials used in the manufacture of products.

Materials that have plasticity may exhibit either of the following:

- **Malleability.** The material is capable of undergoing plastic deformation without rupture, especially metals.
- **Ductility.** The ability of a material to be plastically deformed by elongation without fracture.

All materials have some degree of elasticity and plasticity, but when a material fractures easily it is said to be brittle. A material is brittle if it is liable to fracture when subjected to stress. It has little tendency to deform (or strain) before fracture. This fracture absorbs relatively little energy, even in materials of high strength, and usually makes a snapping sound.



Show the cadets Figure A-3 located at Attachment A.

APPLIED FORCE

The effects of applying force can be illustrated on a cube of material. The side view of the cube is shown as the shape of a square. When no external forces are present the cube is considered in a neutral state.



Show the cadets Figure A-4 located at Attachment A.

When external forces are applied while the cube remains stationary (eg, the cube does not accelerate under the application of the applied force) it is said to be in a non-neutral condition of which there are several possibilities.

Compression. If the cube is supported from below so that it is unable to move, while a downward force is applied on the top of the cube, the cube is said to be in a state of compression. In this state, the cube tends to deform, becoming slightly shorter and wider.



Show the cadets Figure A-5 located at Attachment A.

If the material from which the cube is made is elastic, it will return to its original shape when the compressing force is removed. If the material from which the cube is made is plastic and non-elastic, it will undergo permanent deformation. When the material is long and thin, compressive forces can cause buckling, where the material fails due to elastic instability.



Show the cadets Figure A-6 located at Attachment A.

Tension. If the cube is securely fastened at its lower surface (perhaps glued to the surface upon which it is sitting) and an upward force is applied to its upper surface, the cube is said to be in a state of tension. The effect is to make the cube stretch upward while contracting inward around its sides.



Show the cadets Figure A-7 located at Attachment A.

If the material from which the cube is made is elastic, it will return to its original shape when the tensile (stretching) force is removed. If the material from which the cube is made is plastic and non-elastic, it will undergo permanent deformation.



Show the cadets Figures A-8 and A-9 located at Attachment A.

Shear. If the cube deforms as illustrated in Figure A-8, it is called shear. If the material from which the cube is made is elastic, it will return to its original shape when the shearing force is removed. If the material from which the cube is made is plastic and non-elastic it will undergo permanent deformation.

Shear stress. When forces are applied in such a way that the different parts of the cube try to slide with respect to one another, the effect is also called shearing. If parts of the cube try to slide, it is called shear stress.



Show the cadets Figure A-10 located at Attachment A.

Torsion. Torsion is the twisting of an object due to an applied torque. If the top of the cube is rotated while the bottom is fixed, the cube will twist.

CONFIRMATION OF TEACHING POINT 1

QUESTIONS:

- Q1. What is a static load on a structure?
- Q2. What happens to an object under tension?
- Q3. What will torque do to an object?

ANTICIPATED ANSWERS:

- A1. A load that remains constant.
- A2. The object will stretch while contracting inward around its sides.
- A3. It will twist the object.

Teaching Point 2**Have the cadets, in pairs, design a truss.**

Time: 15 min

Method: Practical Activity

Truss. Any of various structural frames based on the geometric rigidity of the triangle and composed of straight members connected at joints referred to as nodes, subject only to longitudinal compression, tension, or both. At a minimum, a truss will have three members and three nodes. Trusses offer the most strength using the least weight: an important factor in spacecraft design.



Show the cadets Figures B-1 and B-2 located at Attachment B.

A planar truss is one where all the members and nodes lie within a two dimensional plane. A space truss has members and nodes extending into three dimensions.

When designing a truss, consider the following:

- effect of tension versus compression on member sizes and lengths;
- approaches to preventing potential buckling failure modes;
- potential for stress reversal; and
- overall lateral stability (lateral-torsional buckling).

The first step in constructing a truss is to understand what the truss will be used for and what forces will be placed on the truss. When the parameters have been established, putting the design on paper or using computer aided design (CAD) software will save time and material.

The truss will be tested by applying weight at its centre via the suspended container mount. Weight will be added until the truss fails. This test will demonstrate one aspect of truss design as it is an application of only one force on the truss.



Distribute the handout of Attachment C to each cadet.

ACTIVITY

Time: 10 min

OBJECTIVE

The objective of this activity is to have the cadets, in pairs, design a truss to be constructed out of uncooked spaghetti and hot glue.

RESOURCES

Material required by each pair of cadets:

- Photocopy of Attachment C,
- One legal size graph paper pad,
- Two mechanical pencils,
- One eraser,
- One 30-cm ruler,
- One plastic protractor, and
- 24 unbroken strands of uncooked spaghetti.

ACTIVITY LAYOUT

Nil.

ACTIVITY INSTRUCTIONS

1. Distribute the required material to each pair of cadets.
2. Have each pair of cadets design a truss.



The truss will be constructed out of uncooked spaghetti and hot glue. When designing the truss keep these factors in mind:

- The truss will be assessed on its strength to weight ratio. A light truss that supports the same weight as a heavy truss will be assessed a higher value.
- The buckling point of a member is related to its length. The longer the member, the greater the chance of buckling. Shorter pieces of spaghetti are better in compression. Long strands of spaghetti are stronger in tension than they are in compression.
- The suspended container mount consists of a block of plywood with a screw eye in its centre and is used to hold the suspended container of marbles. Be precise with the suspended container mount position and dimensions. All the weight that the truss will carry is supported by this mount.
- Truss members can be made up of more than one strand of spaghetti.
- The truss will be supported on each end by an abutment, represented by tables set 45 cm apart.

SAFETY

Nil.

CONFIRMATION OF TEACHING POINT 2

The cadets' participation in the activity will serve as the confirmation of this TP.

Teaching Point 3**Have the cadets, in pairs, construct and test a truss.**

Time: 50 min

Method: Practical Activity



The truss testing is a competition between the pairs of cadets and not an assessment.

The truss construction should follow the design as closely as possible. Points will be lost for trusses that do not follow the original design or that waste material. Points will be gained for construction technique and neatness.

The suspended container will be filled with marbles. When the truss fails, the amount of marbles in the suspended container will be counted and divided by the weight of the bridge. This ratio will be used in the total score.

Neatness counts!

ACTIVITY

Time: 45 min

OBJECTIVE

The objective of this activity is to have the cadets, in pairs, construct and test a truss.

RESOURCES

Material required by each pair of cadets:

- Suspended container mount,
- Glue gun,
- Hot glue sticks,
- Hobby knife, and
- Uncooked spaghetti.

ACTIVITY LAYOUT

Nil.

ACTIVITY INSTRUCTIONS

1. Distribute the materials to each pair of cadets.
2. Have the cadets, within 35 minutes, use their truss designs from TP 2 to construct the truss.
3. Have the cadets test their trusses for the remaining 10 minutes.
4. Use the scoring sheet at Attachment C to record the test results.



Hot glue is hot enough to cook the spaghetti, which will result in a weakened node or member. Apply only a small amount of heat and glue to connect the members.

SAFETY

Use caution with the hot glue gun and glue. The glue and gun can reach 120–195 degrees Celcius. This is hot enough to burn flesh.

CONFIRMATION OF TEACHING POINT 3

The cadets' participation in the activity will serve as the confirmation of this TP.

END OF LESSON CONFIRMATION

This lesson should be taught in three consecutive periods.

The cadets' construction of a truss will serve as the confirmation of this lesson.

CONCLUSION

HOMEWORK / READING / PRACTICE

Nil.

METHOD OF EVALUATION

Nil.

CLOSING STATEMENT

Although the International Space Station is made largely of aluminum instead of spaghetti, it is an application of the material science of trusses, using the same principles as any truss.

INSTRUCTOR NOTES / REMARKS

Cadets who qualified Advanced Aerospace may assist with this instruction.

REFERENCES

C3-331 McMaster University YES I Can! Science Team. (2009). *How forces act on structures*. Retrieved February 19, 2009, from <http://resources.yesican-science.ca/sts115/aboutforces.html>

THIS PAGE INTENTIONALLY LEFT BLANK

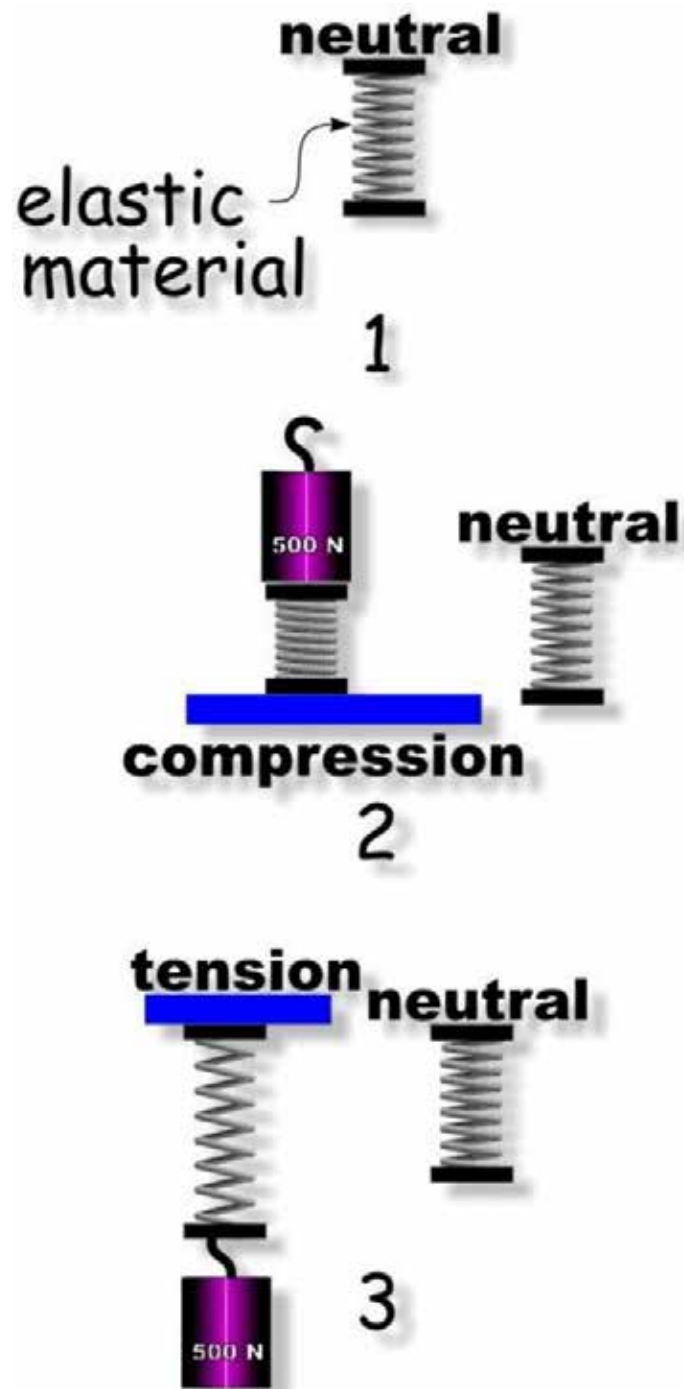

Figure A-1 Elastic Material

Note. From "Materials, Structures, and Forces", 2008, *Structures in Space*. Retrieved November 20, 2008, from <http://resources.yesican-science.ca/sts115/aboutforces.html>

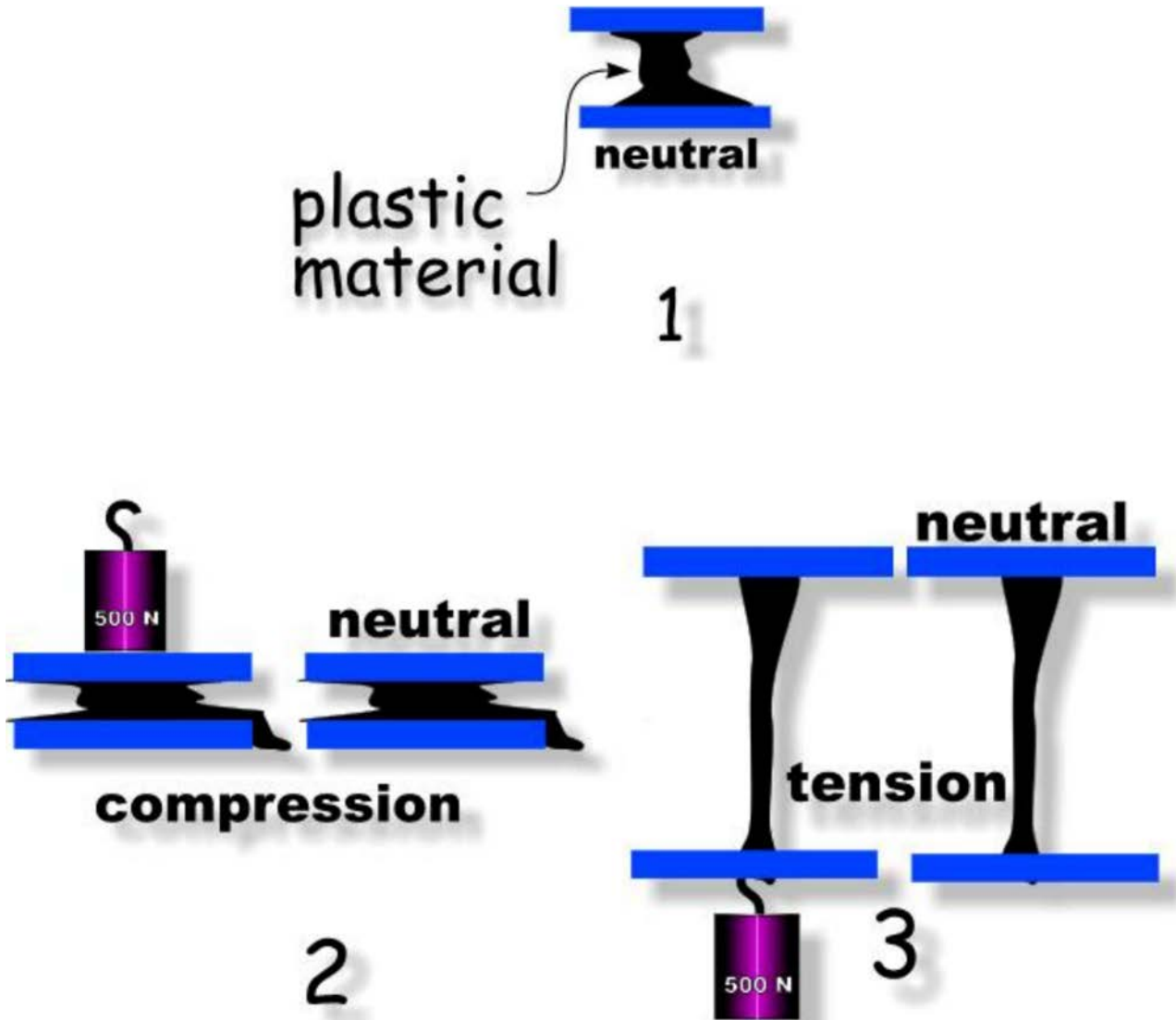

Figure A-2 Plastic Material

Note. From "Materials, Structures, and Forces", 2008, *Structures in Space*. Retrieved November 20, 2008, from <http://resources.yesican-science.ca/sts115/aboutforces.html>

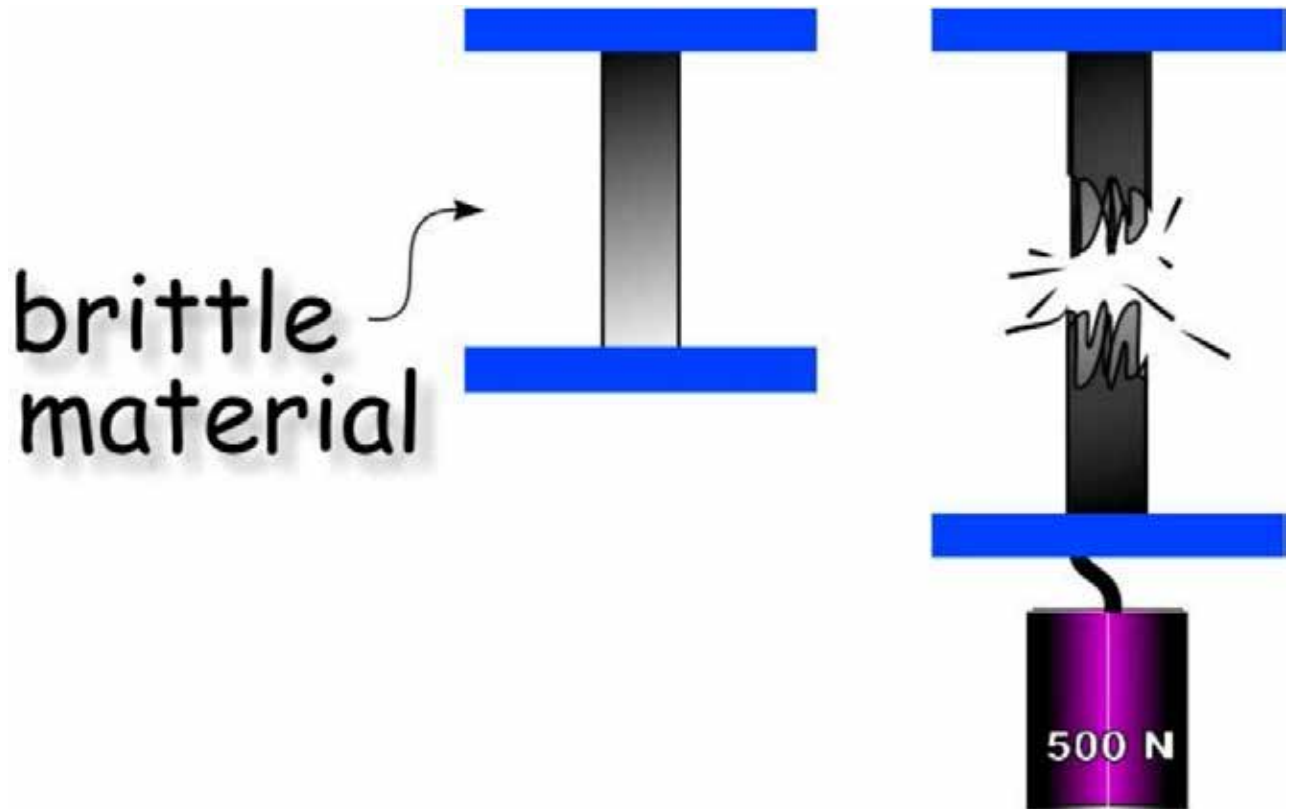

Figure A-3 Brittle Material

Note. From "Materials, Structures, and Forces", 2008, *Structures in Space*. Retrieved November 20, 2008, from <http://resources.yesican-science.ca/sts115/aboutforces.html>

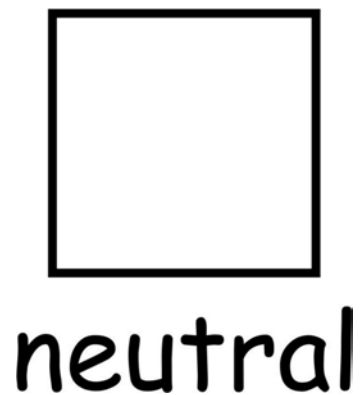

Figure A-4 Cube at Rest

Note. From "Materials, Structures, and Forces", 2008, *Structures in Space*. Retrieved November 20, 2008, from <http://resources.yesican-science.ca/sts115/aboutforces.html>

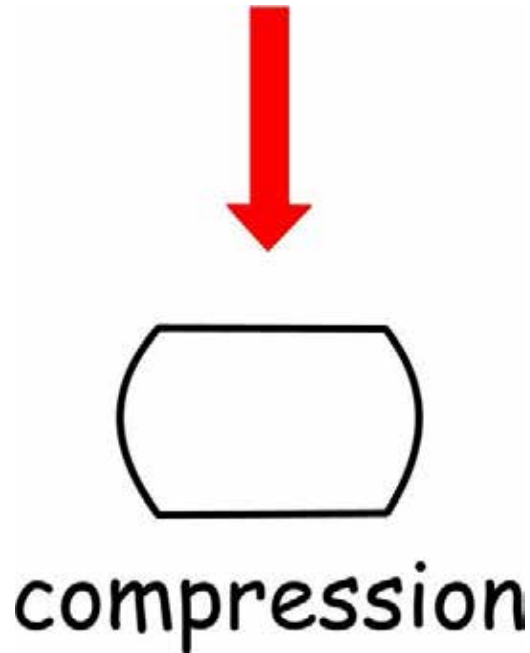

Figure A-5 Cube in Compression

Note. From "Materials, Structures, and Forces", 2008, *Structures in Space*. Retrieved November 20, 2008, from <http://resources.yesican-science.ca/sts115/aboutforces.html>

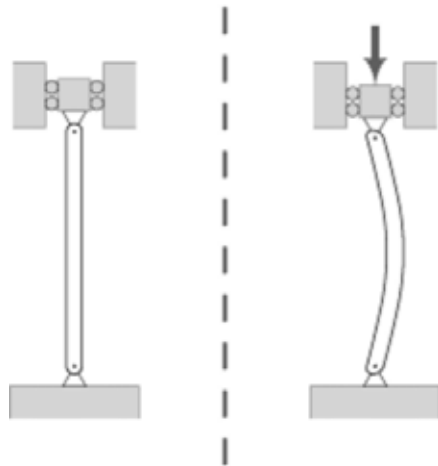

Figure A-6 Compression Causing Buckling

Note. From "Buckling", 2008. Retrieved November 25, 2008, from <http://en.wikipedia.org/wiki/Buckling>

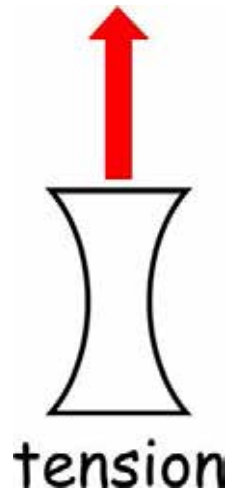

Figure A-7 Cube in Tension

Note. From "Materials, Structures, and Forces", 2008, *Structures in Space*. Retrieved November 20, 2008, from <http://resources.yesican-science.ca/sts115/aboutforces.html>

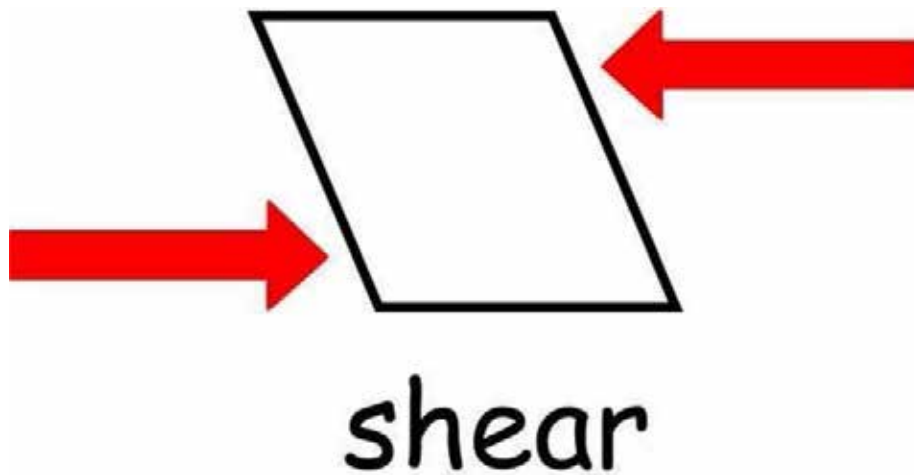
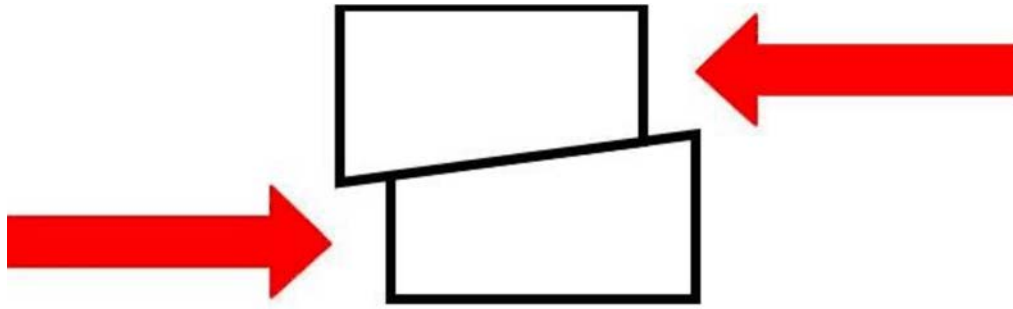

Figure A-8 Cube in Shear

Note. From "Materials, Structures, and Forces", 2008, *Structures in Space*. Retrieved November 20, 2008, from <http://resources.yesican-science.ca/sts115/aboutforces.html>



shear (stress)

Figure A-9 Cube Shear Stress

Note. From "Materials, Structures, and Forces", 2008, *Structures in Space*. Retrieved November 20, 2008, from <http://resources.yesican-science.ca/sts115/aboutforces.html>



Figure A-10 Cube in Torsion

Note. From "Cube Twist", 2008. Retrieved November 25, 2008, from http://www.helleronline.com/fgfc1_main.php?&color=silver&view=front

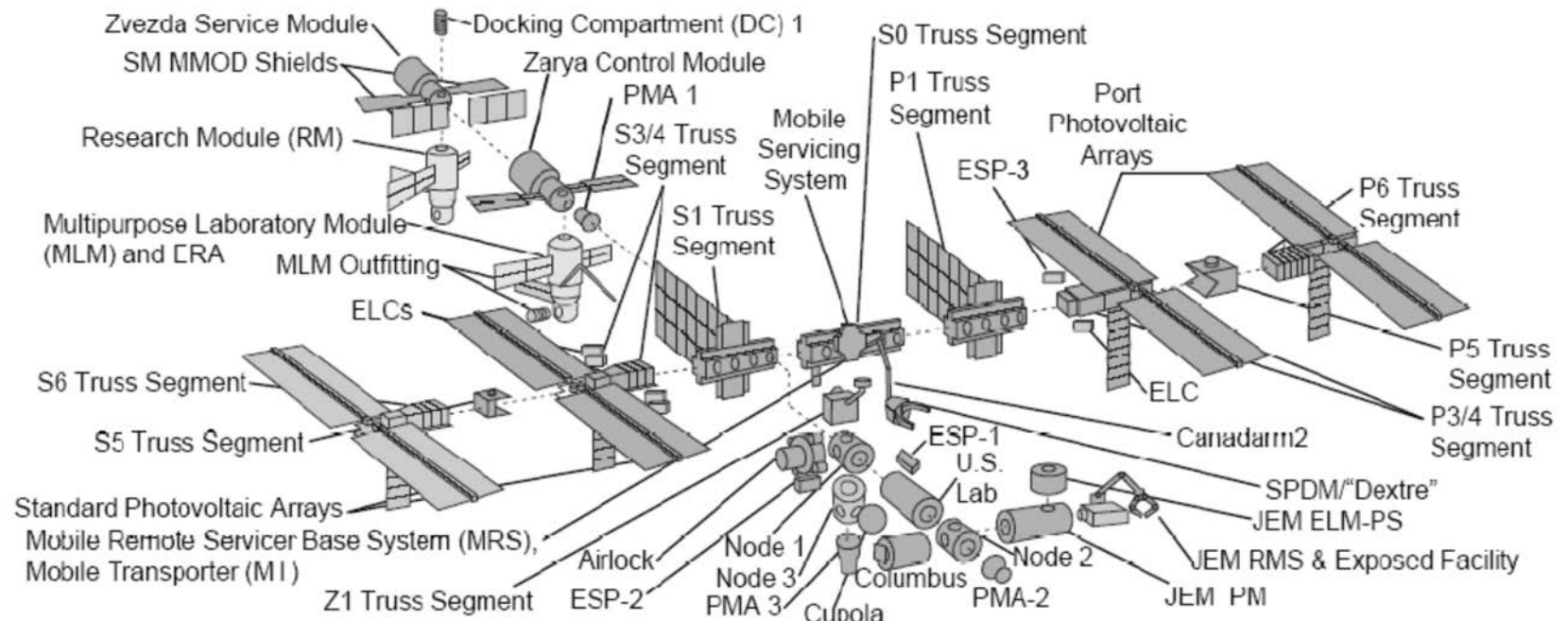

Figure B-1 Exploded View of the ISS Truss Structure

Note. From "Space Exploration", Boeing, 2008, *International Space Station Backgrounder*, Boeing. Retrieved February 19, 2009, from http://www.boeing.com/defense-space/space/spacestation/docs/ISS_overview.pdf

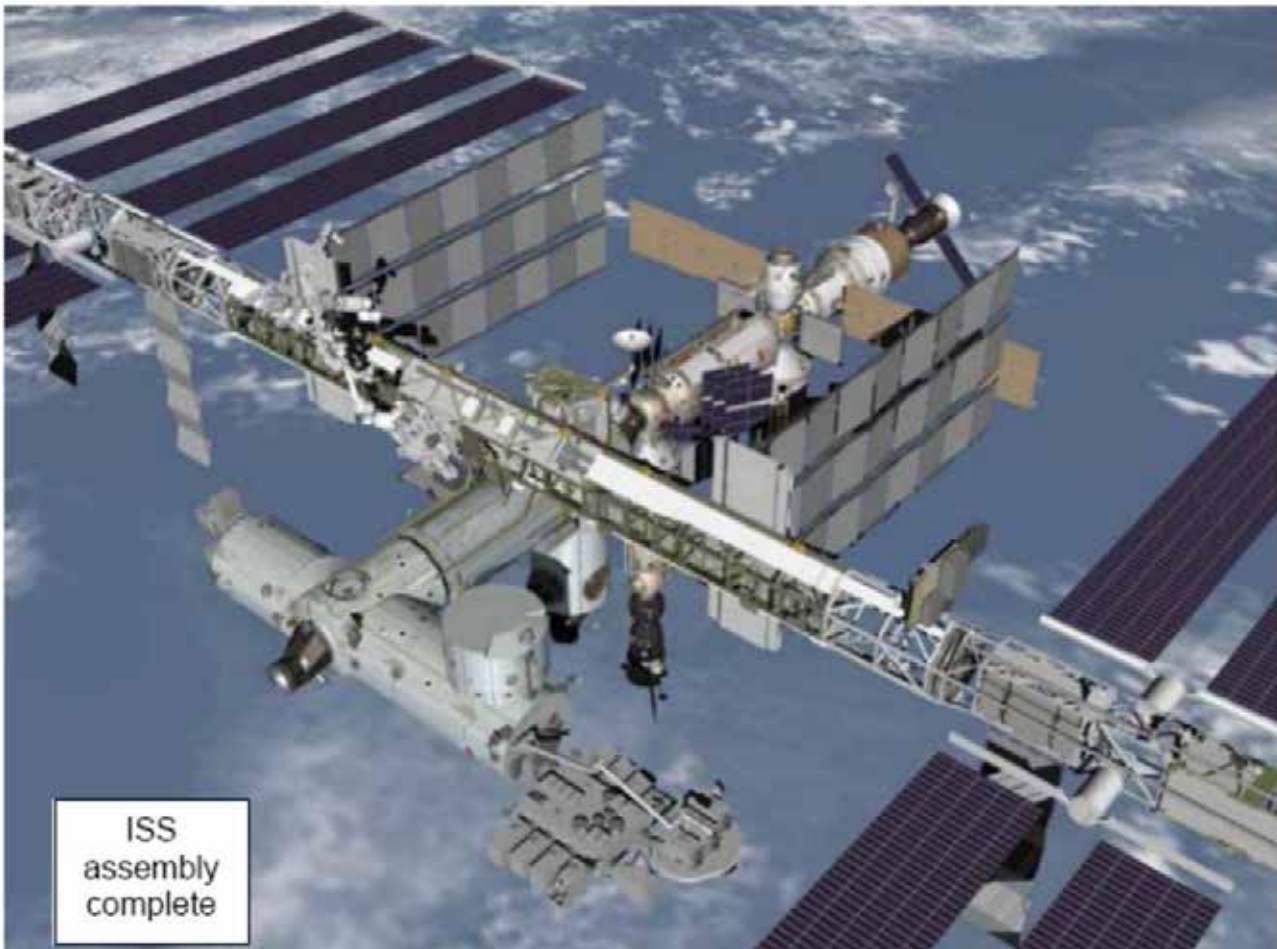

Figure B-2 ISS Truss Structure

Note. From "Space Exploration", Boeing, 2006, *International Space Station Backgrounder*, Boeing. Retrieved November 25, 2008, from http://www.boeing.com/defense-space/space/spacestation/docs/ISS_overview.pdf

TRUSS COMPETITION

Rules and Regulations

Trusses must be constructed of materials provided by the squadron training office. No other materials may be used in the construction of the truss.

Material required by each pair of cadets includes:

- Spaghetti (uncooked, 25 cm long),
- Hot glue gun, and
- Glue sticks.

Parameters for the competition are:

- distance between the abutments: 45 cm,
- length: not less than 47 cm, not greater than 55 cm,
- width: not greater than 10 cm,
- height: not greater than 25 cm,
- no part of the truss will hang below the top of the abutments, and
- time: 40 min.

The provided suspended container mount (SCM) shall be incorporated into the truss. The SCM consists of the following materials:

- 2-cm eye bolt, and
- 8 cm by 8 cm birch plywood square, 4 mm thick.

The following criteria will be used for scoring:

- design,
- quality of construction,
- material use / waste, and
- amount of marbles divided by the weight of the truss.

TRUSS TESTING SCORING SHEET

Cadet Pair	Follows Design ¹	Quality of Construction ²		Length ⁴	Width ⁵	Height ⁶	Amount of Marbles	Weight of Truss	Ratio ⁷	Total
			Material Use ³							
	1/0	1/0	1/0	1/0	1/0	1/0				
	1/0	1/0	1/0	1/0	1/0	1/0				
	1/0	1/0	1/0	1/0	1/0	1/0				
	1/0	1/0	1/0	1/0	1/0	1/0				
	1/0	1/0	1/0	1/0	1/0	1/0				

Note:

1. One point for following design; no points for not following design.
2. One point for neat construction; no points for messy construction.
3. One point for minimum waste; no points for wasting material.
4. Subtract one point for over or under 47–55 cm.
5. Subtract one point for over 10 cm.
6. Subtract one point for over 25 cm.
7. Divide the number of marbles in the suspended container by the bridge weight for this ratio.



**ROYAL CANADIAN AIR CADETS
PROFICIENCY LEVEL FOUR
INSTRUCTIONAL GUIDE**



SECTION 7

EO C440.05 – DESCRIBE ROBOTICS

Total Time:

30 min

PREPARATION

PRE-LESSON INSTRUCTIONS

Resources needed for the delivery of this lesson are listed in the lesson specification located in A-CR-CCP-804/PG-001, *Proficiency Level Four Qualification Standard and Plan*, Chapter 4. Specific uses for said resources are identified throughout the instructional guide within the TP for which they are required.

Review the lesson content and become familiar with the material prior to delivering the lesson.

Create slides of the figures located at Attachments A–C.

PRE-LESSON ASSIGNMENT

Nil.

APPROACH

An interactive lecture was chosen for this lesson to give the cadets an overview of robotics and generate interest in the subject.

INTRODUCTION

REVIEW

Nil.

OBJECTIVES

By the end of this lesson the cadet shall have described robotics and shall be expected to identify types of robots.

IMPORTANCE

It is important for cadets to be familiar with robot types and various robotic applications because they form an important and growing aspect of the aerospace industry in both manufacturing and operations.

Teaching Point 1**Describe types of robots.**

Time: 10 min

Method: Interactive Lecture

A robot is defined as a machine that looks and functions like a human being. A robot is also defined as a machine that is capable of carrying out a complex series of tasks automatically. Some organizations provide special definitions of a robot, such as those found at NASA's ROVER Ranch website, which include:

- a machine that looks like a human being and performs various complex acts similar to those of a human being (such as walking or talking);
- a device that automatically performs complicated, often repetitive, tasks; and
- any mechanism guided by automatic controls.



NASA's ROVER Ranch is a place to learn about robotic engineering at <http://prime.jsc.nasa.gov/ROV/>

AUTONOMOUS SYSTEMS

Autonomous systems are the physical embodiment of machine intelligence. This means that an autonomous system combines artificial intelligence (AI) with the manipulating abilities of remote-controlled systems.

REMOTE-CONTROLLED SYSTEMS

The earliest robots, such as the armoured robot knight created by Leonardo da Vinci in 1495, did not think for themselves. Representing the technology of 1495, Leonardo da Vinci's robot consisted of two independent systems:

- three-degree-of-freedom legs, ankles, knees, and hips; and
- four-degree-of-freedom arms with articulated shoulders, elbows, wrists, and hands.



Examples of Degrees of Freedom (DOF) are:

- tilting forward and backward (pitching);
- turning left and right (yawing);
- tilting side to side (rolling);
- moving up and down (heaving);
- moving left and right (swaying); and
- moving forward and backward (surging).



Show the cadets the slide of Figures A-1 and A-2 located at Attachment A.

The orientation of the arms on Leonardo's robot indicates that it was designed for whole-arm grasping, which means that all the joints moved in unison. A mechanical, analog-programmable controller within the chest provided power and control for the arms.

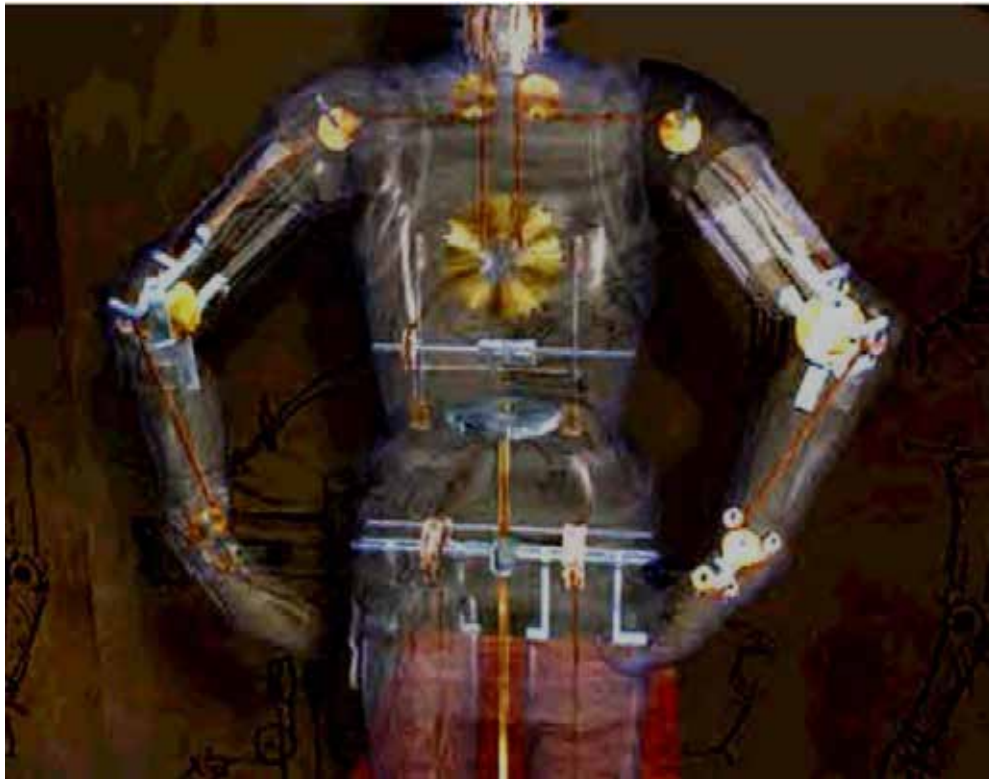

Figure 1 Leonardo's Mechanical Analog-Programmable Controller

Note. From "Z-Kat the Digital Surgery Company", by R. Abovitz, 2001, *Leonardo's Robot*, Copyright 2008 by R. Abovitz. Retrieved November 18, 2008, from http://www.z-kat.com/company/adv_research/leonardo.shtml

The legs were powered by an external crank arrangement driving the cable, which was connected to key locations in the ankle, knee, and hip. This armoured robot knight was designed to sit up, wave its arms, and move its head via a flexible neck while opening and closing its anatomically correct jaw. It may have made sounds to the accompaniment of automated drums. On the outside, the robot is dressed in a typical German-Italian suit of armour of the late fifteenth century.



Modern robots such as the Canadarm and the Canadarm2 combine the two modes of remote control and autonomy.

Canadarm: Shuttle Remote Manipulator System (SRMS)

The space shuttle's general-purpose computer (GPC) controls the movement of the SRMS. The astronauts use a hand controller, which tells the computer what the astronaut would like the arm to do. Built-in software then studies the astronaut's commands and calculates which joints should move, what direction to move them in, how fast to move them and at what angle to move.

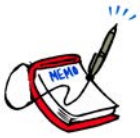

Show the cadets the slide of Figure A-3 located at Attachment A.



Figure A-3 is a scale drawing of the Canadarm.

While the computer is issuing commands to each of the joints, it monitors each joint every 80 milliseconds. Any movements of the astronaut's hand are re-examined and recalculated by the GPC and updated commands are then sent out to each of the joints.

Should a failure occur, the GPC automatically applies the brakes to all joints and notifies the astronaut of a failure condition. The control system also provides a continuous display of joint rates and speeds, which are displayed on monitors located on the flight deck of the shuttle. As with any control system, the GPC can be overridden and the astronaut can operate the joints individually from the flight deck.

CONFIRMATION OF TEACHING POINT 1

QUESTIONS:

- Q1. What are autonomous systems?
- Q2. What two modes do robots such as the Canadarm and the Canadarm2 combine?
- Q3. What computer controls the SRMS?

ANTICIPATED ANSWERS:

- A1. Autonomous systems are the physical embodiment of machine intelligence.
- A2. The two modes combined in the Canadarm and the Canadarm2 are remote control and autonomy.
- A3. The space shuttle's general-purpose computer (GPC) controls the movement of the SRMS.

Teaching Point 2

Describe robotic applications.

Time: 15 min

Method: Interactive Lecture

Robots are especially desirable for certain work functions because, unlike humans, they:

- never get tired;
- can endure physical conditions that are uncomfortable, dangerous or even airless;
- do not get bored by repetition; and
- cannot be distracted from the task at hand.

Early industrial robots that handled radioactive material in atomic labs were called master / slave manipulators. They were connected with mechanical linkages and steel cables. Remote arm manipulators can now be moved by push buttons, switches or joysticks.

Robots sometimes have advanced sensory systems that process information and appear to function as if they have brains. Their "brain" is actually a form of computerized AI, which allows a robot to perceive conditions and decide on a course of action based on these conditions.

A robot may include any of the following components:

- **Effectors.** "Arms", "legs", "hands", "feet".
- **Sensors.** Parts that act like senses, can detect objects or things like heat and light and convert the information into symbols that computers understand.
- **Computer.** The brain that contains instructions called algorithms to control the robot.
- **Equipment.** Includes tools and mechanical fixtures.

Characteristics that make autonomous robots different from regular machinery are that they usually function by themselves, are sensitive to their environment, adapt to variations in the environment or to errors in prior performance, are task-oriented and often have the ability to try different methods to accomplish a task.

INDUSTRIAL FABRICATION

Typical industrial robots do jobs that are difficult, dangerous or dull. They lift heavy objects, paint, handle chemicals, and perform assembly work. They perform the same job hour after hour, day after day with precision. They do not get tired and they do not make errors associated with fatigue and are ideally suited to performing repetitive tasks.

The major categories of industrial robots, differentiated by mechanical structure are:

- **Cartesian / Gantry robot.** Used for pick and place work, application of sealant, assembly operations, handling machine tools and arc welding. It is a robot whose arm has three joints and whose axes are coincident with Cartesian coordinates on X, Y and Z axes.



Show the cadets the slide of Figures B-1 and B-2 located at Attachment B.

- **Cylindrical robot.** Used for assembly operations, handling machine tools, spot welding, and handling die-casting machines. It is a robot whose axes form a cylindrical coordinate system.



Show the cadets the slide of Figure B-3 located at Attachment B.

- **Polar (Spherical) robot.** Used for handling machine tools, spot welding, die-casting, fettling machines, gas welding and arc welding. It is a robot whose axes form polar coordinates.



Show the cadets the slide of Figure B-4 located at Attachment B.

- **SCARA robot.** Used for pick and place work, application of sealant, assembly operations and handling machine tools. It is a robot that has two parallel rotary joints to provide compliance in a plane.



Show the cadets the slide of Figure B-5 located at Attachment B.

- **Articulated robot.** Used for assembly operations, die-casting, fettling machines, gas welding, arc welding and spray painting. It is a robot whose arm has at least three rotary joints.



Show the cadets the slide of Figure B-6 located at Attachment B.

- **Parallel robot.** One use is a mobile platform handling cockpit flight simulators. It is a robot whose arms have concurrent prismatic or rotary joints.



Show the cadets the slide of Figures B-7 and B-8 located at Attachment B.

Machining

Computer Numerical Control (CNC) refers to a computer controller that reads computer code instructions and drives a machine tool—a powered mechanical device typically used to fabricate components by the selective removal of material from a larger block of material. The operating parameters of the CNC are altered by changing the software, making CNC machines a type of robot.

Cutting

The most common methods of cutting used by robots are plasma cutting and oxyfuel cutting.

Plasma cutting is a process that uses a high velocity jet of ionized gas delivered from a constricting orifice. Plasma cutting takes place when a high-velocity stream of gas (plasma) is forced through a narrow torch. Plasma cutting can be performed on any type of conductive metal—mild steel, aluminum and stainless steel are some examples.

Oxyfuel cutting is a process that cuts by burning, or oxidizing, the metal it is severing. It is therefore limited to steel and other ferrous metals that support the oxidizing process.

Assembling

Assembly robots have expanded production capabilities in the manufacturing world, making the assembly process faster, more efficient and more precise than ever before. Robots have saved workers from tedious and dull assembly line jobs, and increased production and savings in the process. One class of assembly robot is the Selective Compliant Articulated Robot for Assembly (SCARA) Robot.



Show the cadets the slide of Figure B-5 located at Attachment B.

The work characteristics of robots give them several advantages for industrial assembly, including:

- **No fatigue.** An assembly robot can work every day, every hour without pause.
- **More output.** The consistent output of a robotic system along with quality, and repeatability are unmatched even with the most challenging of applications.
- **Better performance.** Automated systems provide precise, exact performance. Many of them are equipped with vision technology to aid in production.
- **Savings.** Robot assembly systems create savings by eliminating downtime and labour costs, while increasing production and performance.

Welding

There are two popular types of industrial welding robots; Articulating and Cartesian.

- **Articulating robots.** Employ arms and rotating joints. These robots move like a human arm with a rotating wrist at the end. This creates an irregularly shaped robotic working zone.
- **Cartesian robots.** Move in line in any of three axes (X, Y, Z). In addition to linear movement of the robot along axes there is a wrist attached to the robot to allow rotational movement. This creates a robotic working zone that is box shaped.

EXPLORING

Underwater Exploration



Show the cadets the slide of Figure C-1 located at Attachment C.

A seaglider is an Autonomous Underwater Vehicle (AUV) that measures temperature, salinity, depth-averaged current and other quantities in the ocean. A seaglider uses satellite data telemetry to receive commands and send the measurements it collects in near-real time. A seaglider AUV collects ocean physical properties across a range of depths and areas for oceanographers and military planners.

Deep Space 1 (DS1)

Launched in October 1998, Deep Space 1 (DS1) was the first mission of NASA's new millennium program, chartered to validate new technologies important for future space and earth science programs. The advanced technology payload that was tested on DS1 included a solar-powered Ion Propulsion System (IPS), solar concentrator arrays, an autonomous on-board optical navigation system and an autonomous artificial intelligence (AI) system known as Remote Agent.



Show the cadets the slide of Figure C-2 located at Attachment C.



Figure C-2 shows DS1 trajectory: The dotted portion of the trajectory shows where the DS1 was coasting (ballistic flight) and the solid portion indicates where the IPS thrust was turned on, accelerating the spacecraft.

The autonomous optical navigation system on board DS1 used images of asteroids and stars collected by the onboard camera system, while the onboard navigator system computed and corrected the spacecraft's course.

The autonomous operations system was composed of an AI "agent" that planned, made decisions, and operated by itself.

SPACE

Space-based robotic technology falls within the following three broad mission areas:

- exploration robotics,
- science payload maintenance, and
- on-orbit servicing.

Important robotic devices proven in space include:

- Remotely Operated Vehicle (ROV) such as the Mars Exploration Rovers, and
- Remote Manipulator System (RMS) such as the Canadarm.

An ROV can be an unmanned spacecraft that remains in flight, a lander that lands on a body such as a moon, asteroid or planet and operates from a stationary position, or a rover that can move over terrain once it has landed. One of the best known ROV's is the Sojourner rover that was deployed by the Mars Pathfinder spacecraft.



Show the cadets the slide of Figure C-3 located at Attachment C.

EMERGENCY SERVICES

Robots can resolve high-risk scenarios safely, including bomb disposal, hostage situations, search and rescue and other dangerous incidents. Robots can detect explosive vapors and particulates emanating from munitions and Improvised Explosive Devices (IEDs) while keeping the operator and civilians out of harm's way. They can drive to and reach through windows, under vehicles and around obstructing objects and place ultra-sensitive explosive detectors close to suspicious packages and other potentially dangerous items.

MILITARY

Robots can carry heavy payloads, travel over rough terrain and climb stairs while maintaining full mobility. When equipped with appropriate equipment, they can support a variety of critical missions, including:

- battlefield casualty extraction,
- Explosive Ordnance Disposal (EOD),
- vehicle-borne Improvised Explosive Device (IED) detection,
- physical security,
- firefighting,
- Special Weapons And Tactics (SWAT),
- reconnaissance,
- hazardous material handling,
- chemical-biological weapon detection,
- building clearance,
- target acquisition, and
- weaponized missions.

Sniper Detection



Show the cadets the slide of Figure C-4 located at Attachment C.

By providing superior situational awareness, a robot can support safer ground troop movement. It can find the point of hostile gunfire without exposing ground troops, allowing them to move more safely.

CONFIRMATION OF TEACHING POINT 2

QUESTIONS:

- Q1. What are two properties of robots that make them especially desirable for certain jobs?
- Q2. What was the name of the AI on DS1?
- Q3. Name three possible military missions for robots.

ANTICIPATED ANSWERS:

- A1. Properties of robots that make them especially desirable for certain jobs include:
 - robots never get tired;
 - robots can endure physical conditions that are uncomfortable or even dangerous;
 - robots operate in airless conditions;

- robots do not get bored by repetition; and
- robots cannot be distracted from the task at hand.

A2. Remote agent.

A3. Possible military missions for robots include:

- battlefield casualty extraction,
- EOD,
- vehicle-borne IED detection,
- physical security,
- firefighting,
- SWAT,
- reconnaissance,
- hazardous material handling,
- chemical-biological weapon detection,
- building clearance,
- target acquisition, and
- weaponized missions.

END OF LESSON CONFIRMATION

QUESTIONS:

- Q1. What two modes do robots such as the Canadarm and the Canadarm2 combine?
- Q2. What characteristics make autonomous robots different from regular machinery?
- Q3. What are five applications of robots?

ANTICIPATED ANSWERS:

- A1. Remote control and autonomy.
- A2. Characteristics that make autonomous robots different from regular machinery are that they:
- usually function by themselves;
 - are sensitive to their environment;
 - adapt to variations in the environment or to errors in prior performance;
 - are task oriented; and
 - have the ability to try different methods to accomplish a task.
- A3. Industrial fabrication, exploration, space, emergency services, and military.

CONCLUSION

HOMEWORK / READING / PRACTICE

Nil.

METHOD OF EVALUATION

Nil.

CLOSING STATEMENT

Robots and various robotic applications are encountered every day in every walk of life. They form an important and growing aspect of the aerospace industry in both manufacturing and operations.

INSTRUCTOR NOTES / REMARKS

Cadets who are qualified Advanced Aerospace may assist with this instruction.

REFERENCES

C3-292 NASA. (2003). *Rover ranch: K-12 experiments in robotic software*. Retrieved November 20, 2008, from <http://prime.jsc.nasa.gov/ROV/>

THIS PAGE INTENTIONALLY LEFT BLANK



Figure A-1 Leonardo da Vinci's Robot Drawing

Note. From "Z-Kat the Digital Surgery Company", by R. Abovitz, 2001, *Leonardo's Robot*, Copyright 2008 by R. Abovitz. Retrieved November 18, 2008, from http://www.z-kat.com/company/adv_research/leonardo.shtml



Figure A-2 Leonardo da Vinci's Robot

Note. From "Z-Kat the Digital Surgery Company", by R. Abovitz, 2001, *Leonardo's Robot*, Copyright 2008 by R. Abovitz. Retrieved November 18, 2008, from http://www.z-kat.com/company/adv_research/leonardo.shtml

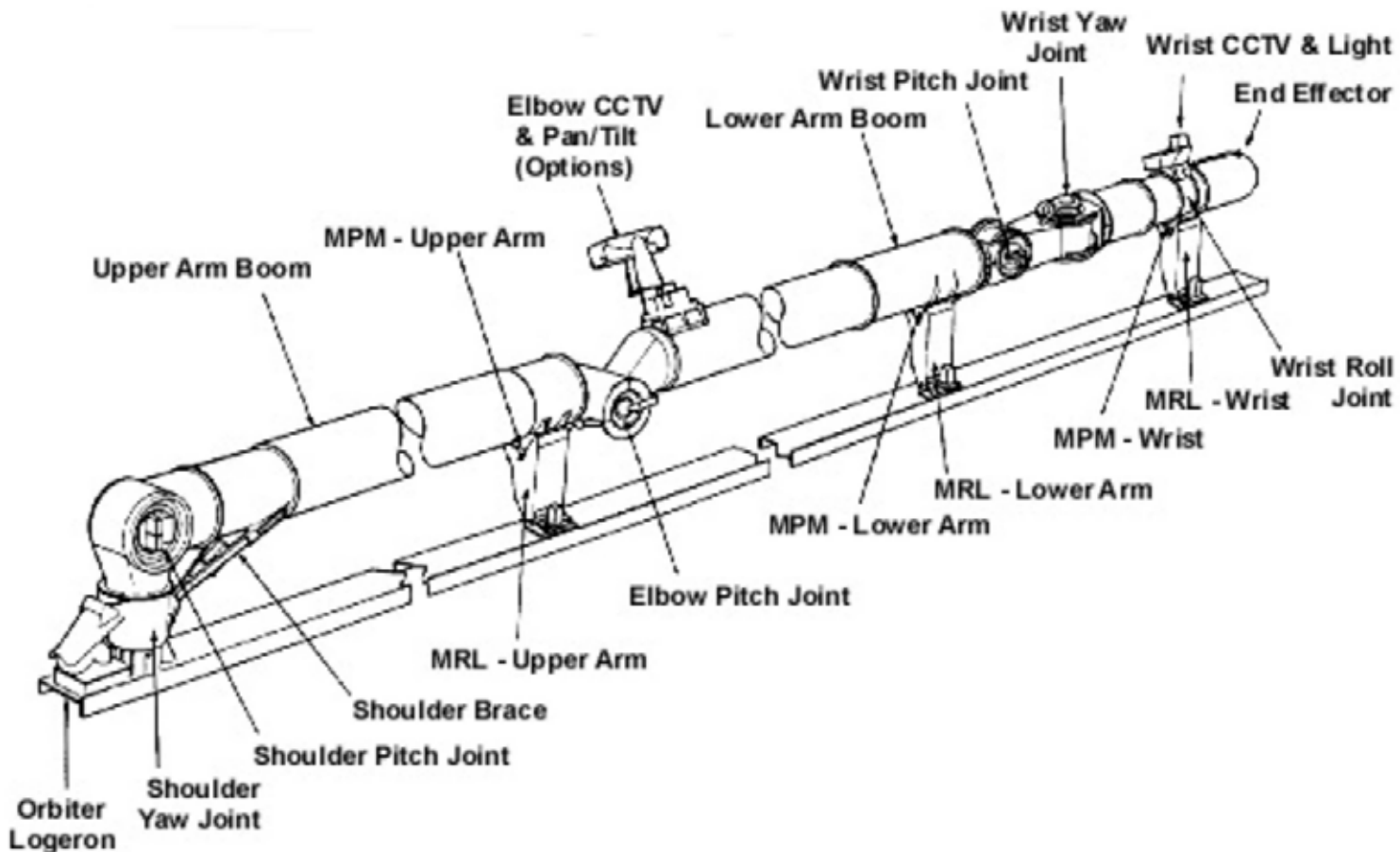

Figure A-3 Canadarm

Note. From Canadian Space Agency, 2006, *The Structure of Canadarm*. Retrieved November 18, 2008, from <http://www.asc-csa.gc.ca/eng/canadarm/description.asp>

Cartesian Robot

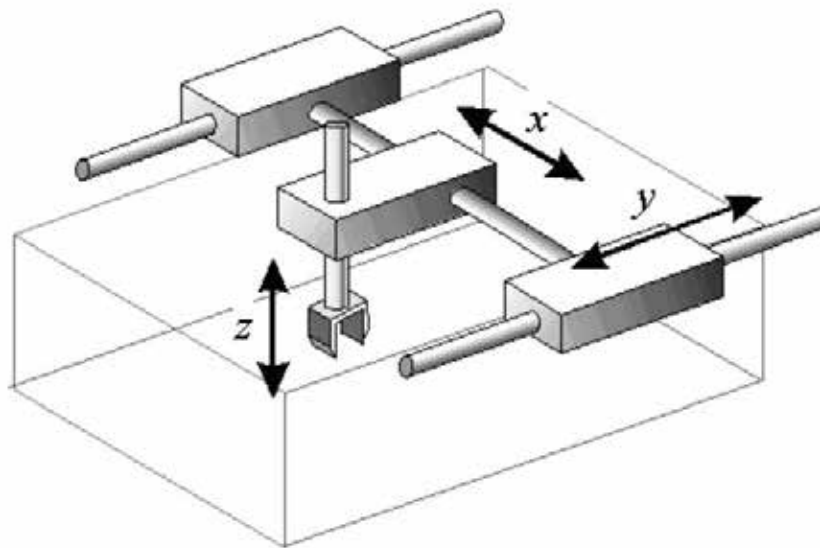

Figure B-1 Cartesian Robot

Note. From "ROVer Ranch K-12 Experiments in Robotic Software" by NASA, 2003, *Types of Robots*. Retrieved November 17, 2008, from <http://prime.jsc.nasa.gov/ROV/types.html>

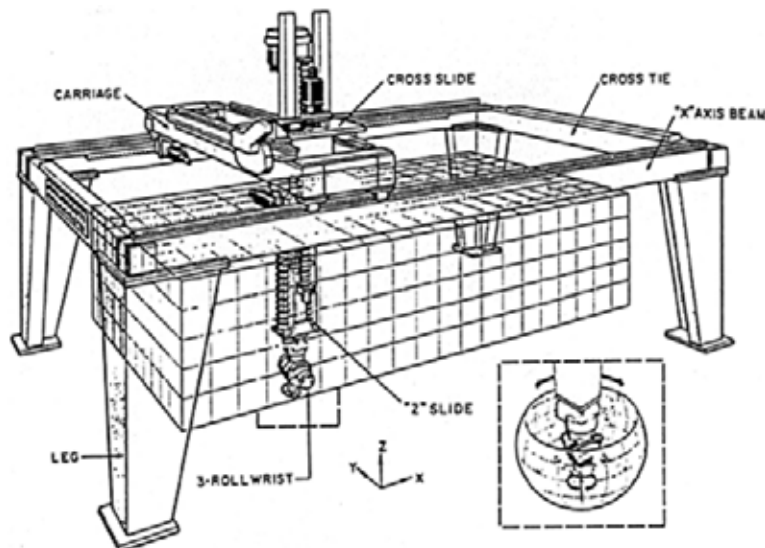

Figure B-2 Cartesian Gantry Robot

Note. From "ROVer Ranch K-12 Experiments in Robotic Software" by NASA, 2003, *Types of Robots*. Retrieved November 17, 2008, from <http://prime.jsc.nasa.gov/ROV/types.html>

Cylindrical Robot

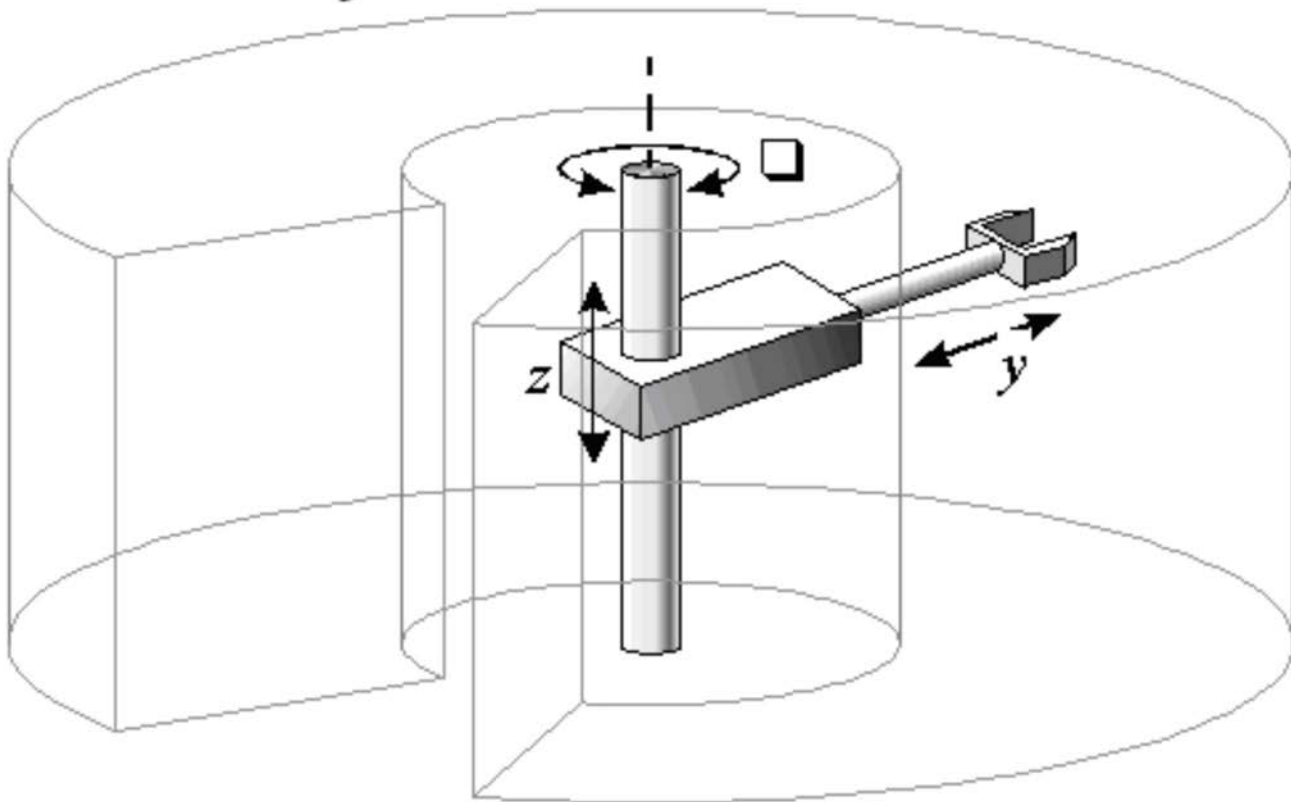

Figure B-3 Cylindrical Robot

Note. From "ROVer Ranch K-12 Experiments in Robotic Software" by NASA, 2003, *Types of Robots*. Retrieved November 17, 2008, from <http://prime.jsc.nasa.gov/ROV/types.html>

Polar Robot

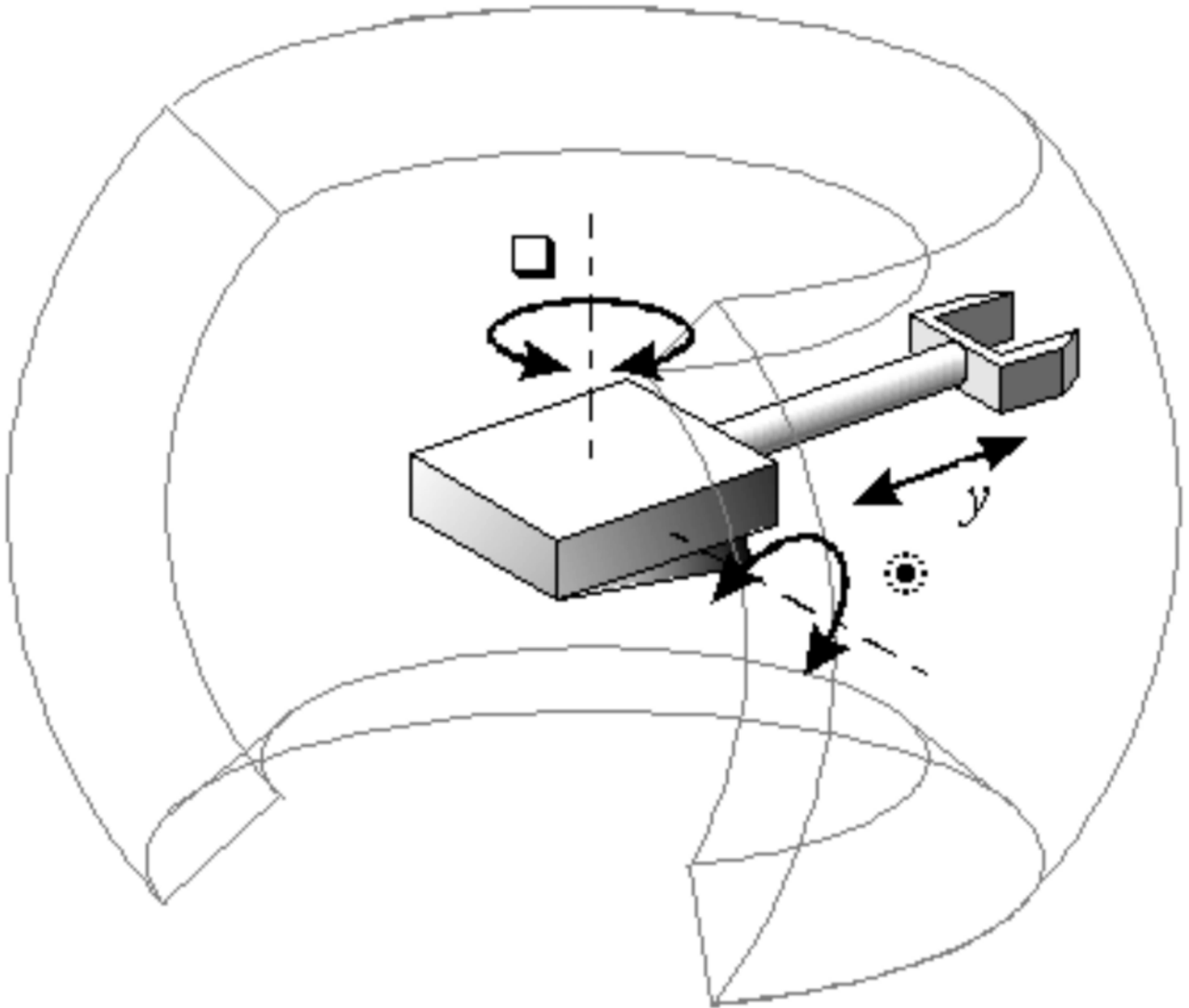

Figure B-4 Polar Robot

Note. From "ROVer Ranch K-12 Experiments in Robotic Software" by NASA, 2003, *Types of Robots*. Retrieved November 17, 2008, from <http://prime.jsc.nasa.gov/ROV/types.html>

SCARA Robot

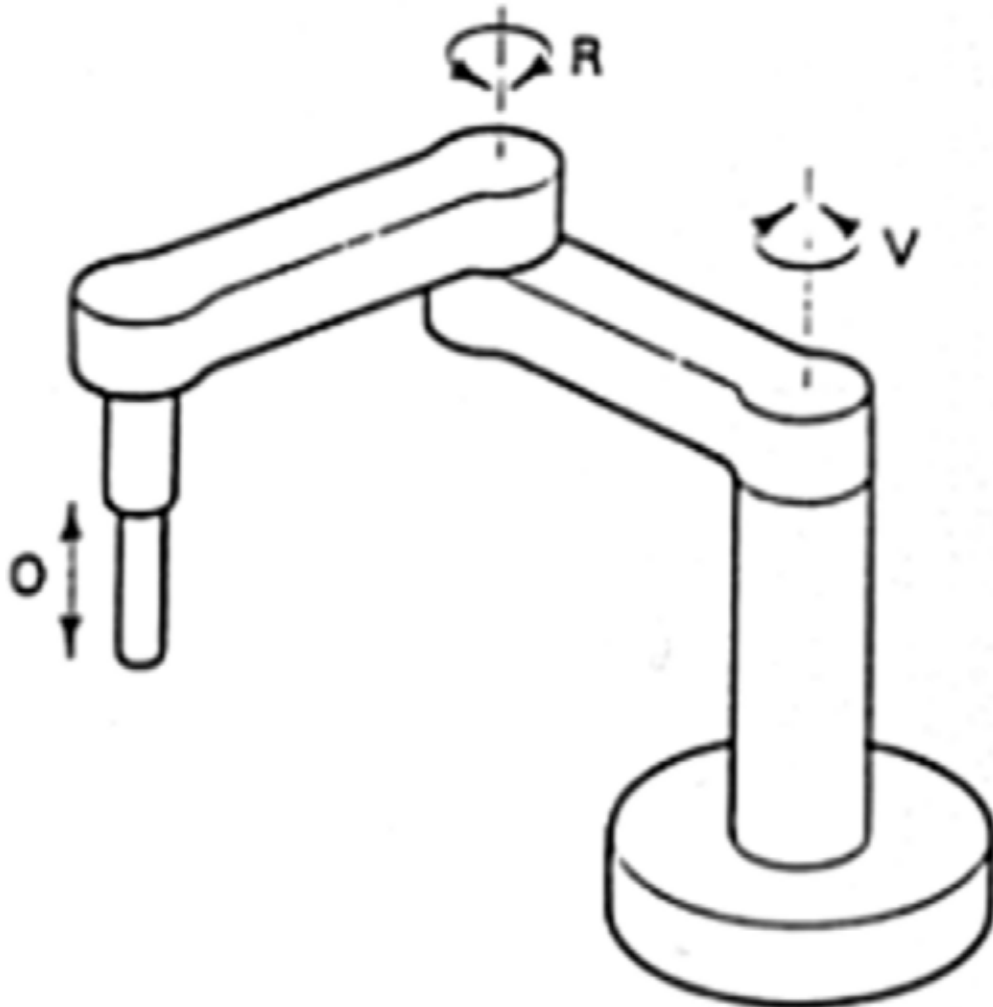

Figure B-5 Selective Compliant Articulated Robot for Assembly (SCARA) Robot

Note. From "ROVer Ranch K-12 Experiments in Robotic Software" by NASA, 2003, *Types of Robots*. Retrieved November 17, 2008, from <http://prime.jsc.nasa.gov/ROV/types.html>

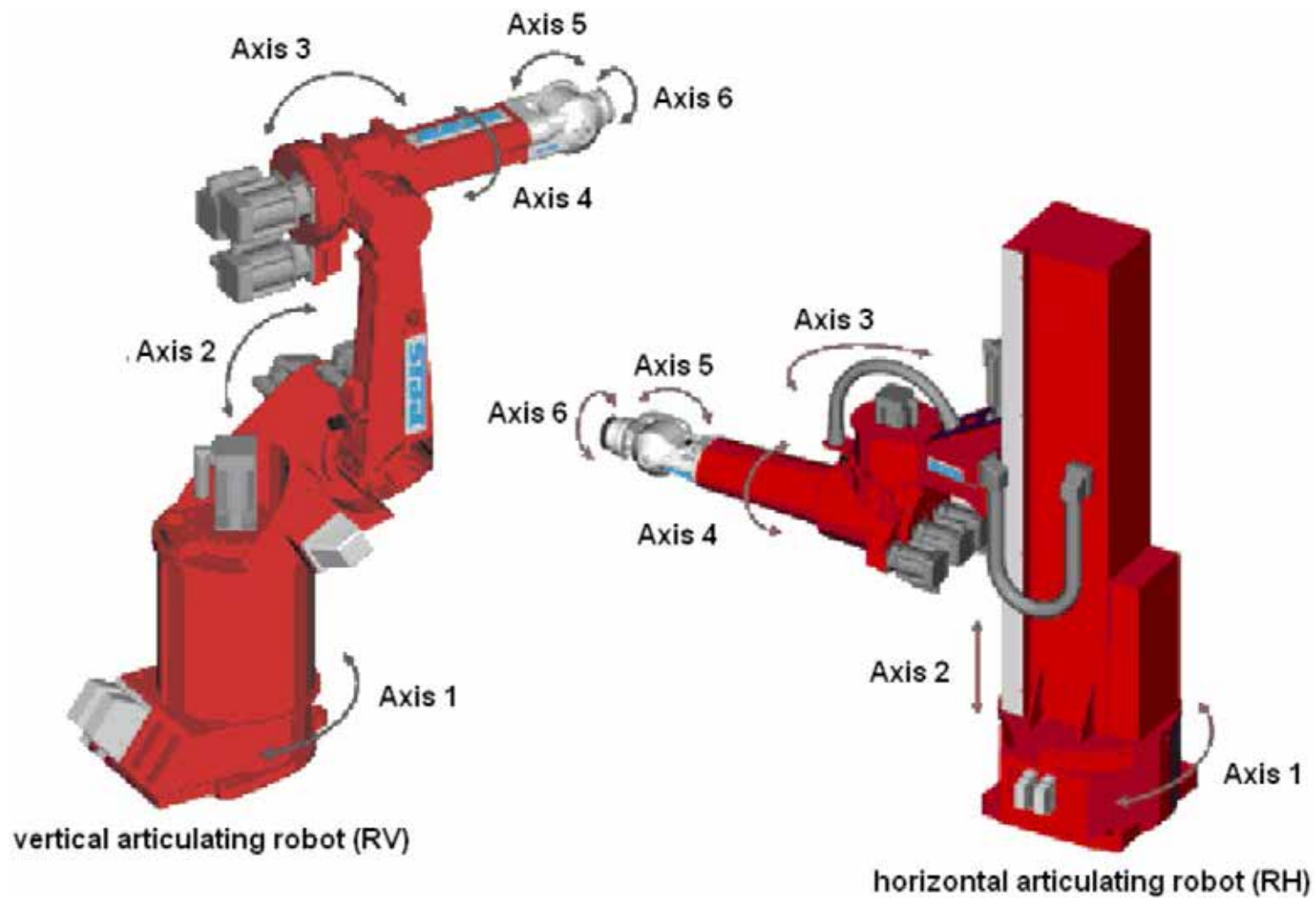

Figure B-6 Articulated Robots

Note. From "Robotics & Automation Home: Types of Robots" by Olympus Technologies Ltd., 2008, *Articulating Robots*. Retrieved November 22, 2008, from <http://www.olympustechnologies.co.uk/Robotics/types-articulating.htm>

Parallel Robot

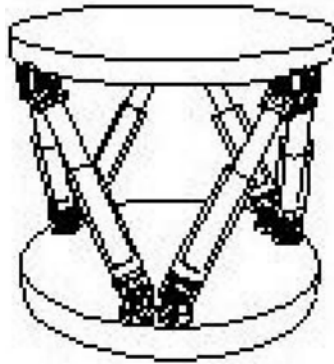

Figure B-7 Parallel Robot

Note. From "ROVer Ranch K-12 Experiments in Robotic Software" by NASA, 2003, *Types of Robots*. Retrieved November 17, 2008, from <http://prime.jsc.nasa.gov/ROV/types.html>

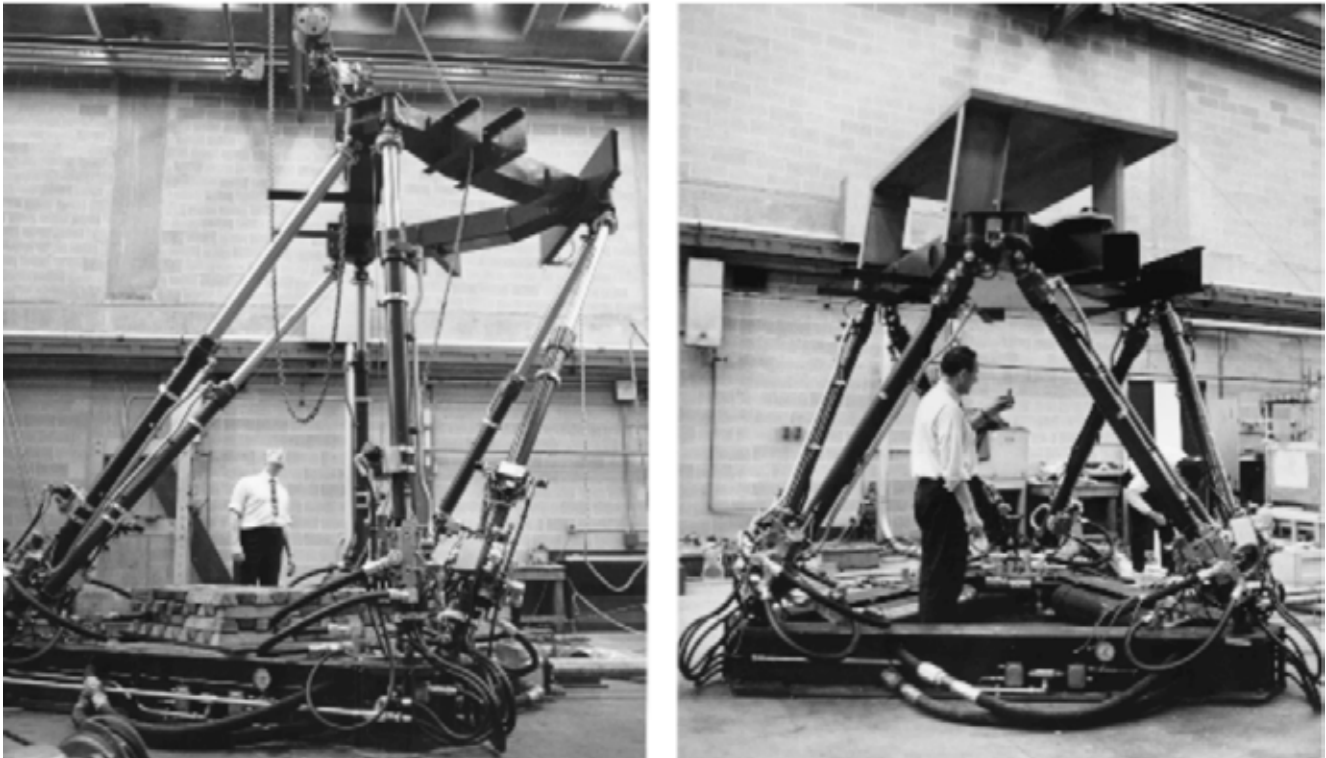

Figure B-8 Parallel Robot: An Early Flight Simulator

Note. From "Reviews in the Field of Parallel Mechanisms", by ParalleMIC, 2003, Copyright 2003 by Ilian Bonev, *The True Origins of Parallel Robots*. Retrieved November 22, 2008, from <http://www.olympustechnologies.co.uk/Robotics/types-articulating.htm>



Figure C-1 Seaglider

Note. From "Robots That Make a Difference", by iRobot, 2008, *Missions for Maritime Operations: Seaglider*, Copyright 2007, by iRobot. Retrieved November 20, 2008, from <http://www.irobot.com/sp.cfm?pageid=393>

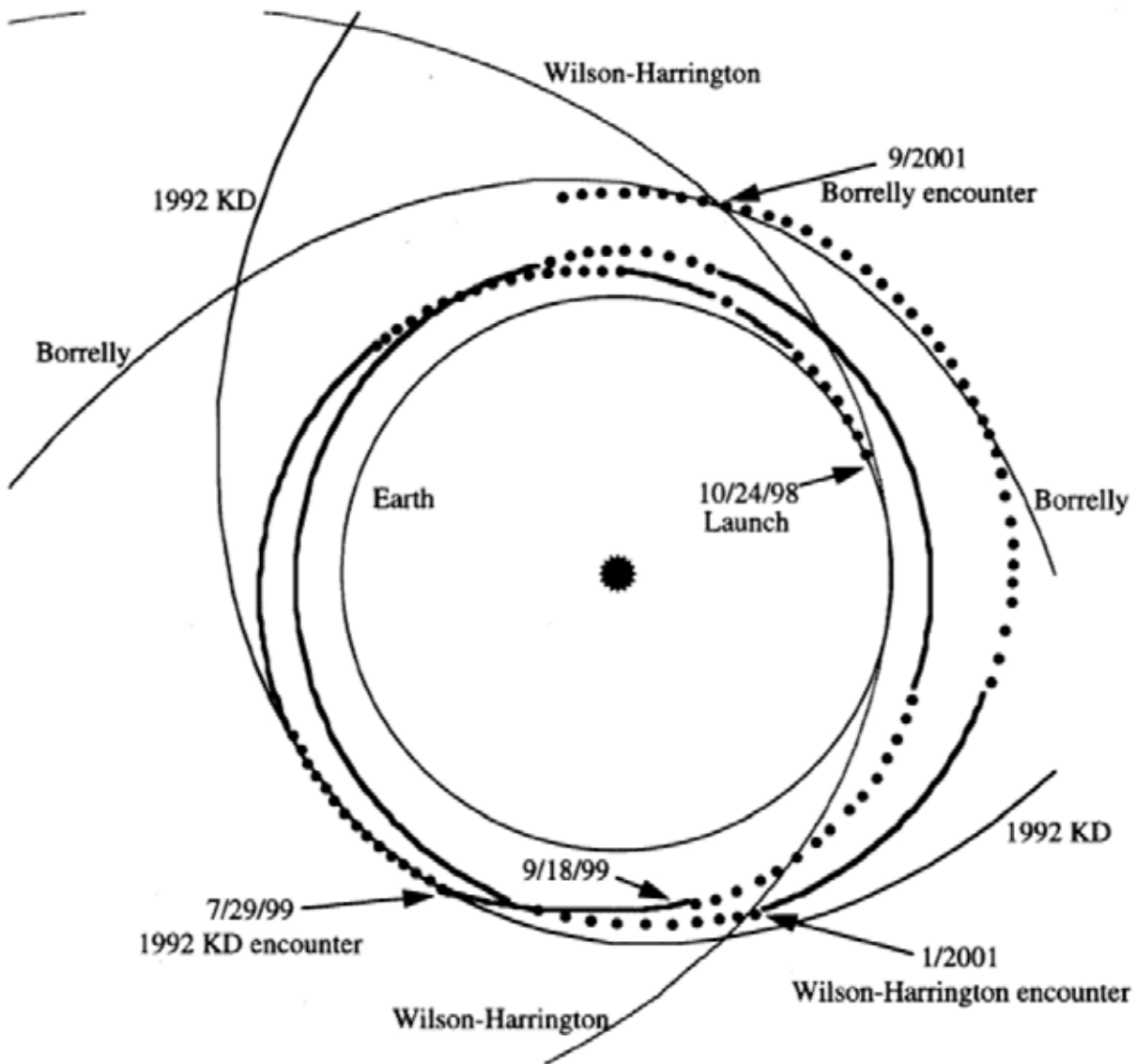

Figure C-2 DS1 Trajectory

Note. From *Results From the Deep Space 1 Technology Validation Mission*, by M. Rayman, P. Varghese, D. Lehman, and L. Livesay. Copyright 1999 by the American Institute of Aeronautics and Astronautics, Inc. Retrieved November 20, 2008, from http://nmp.jpl.nasa.gov/ds1/DS1_Primary_Mission.pdf

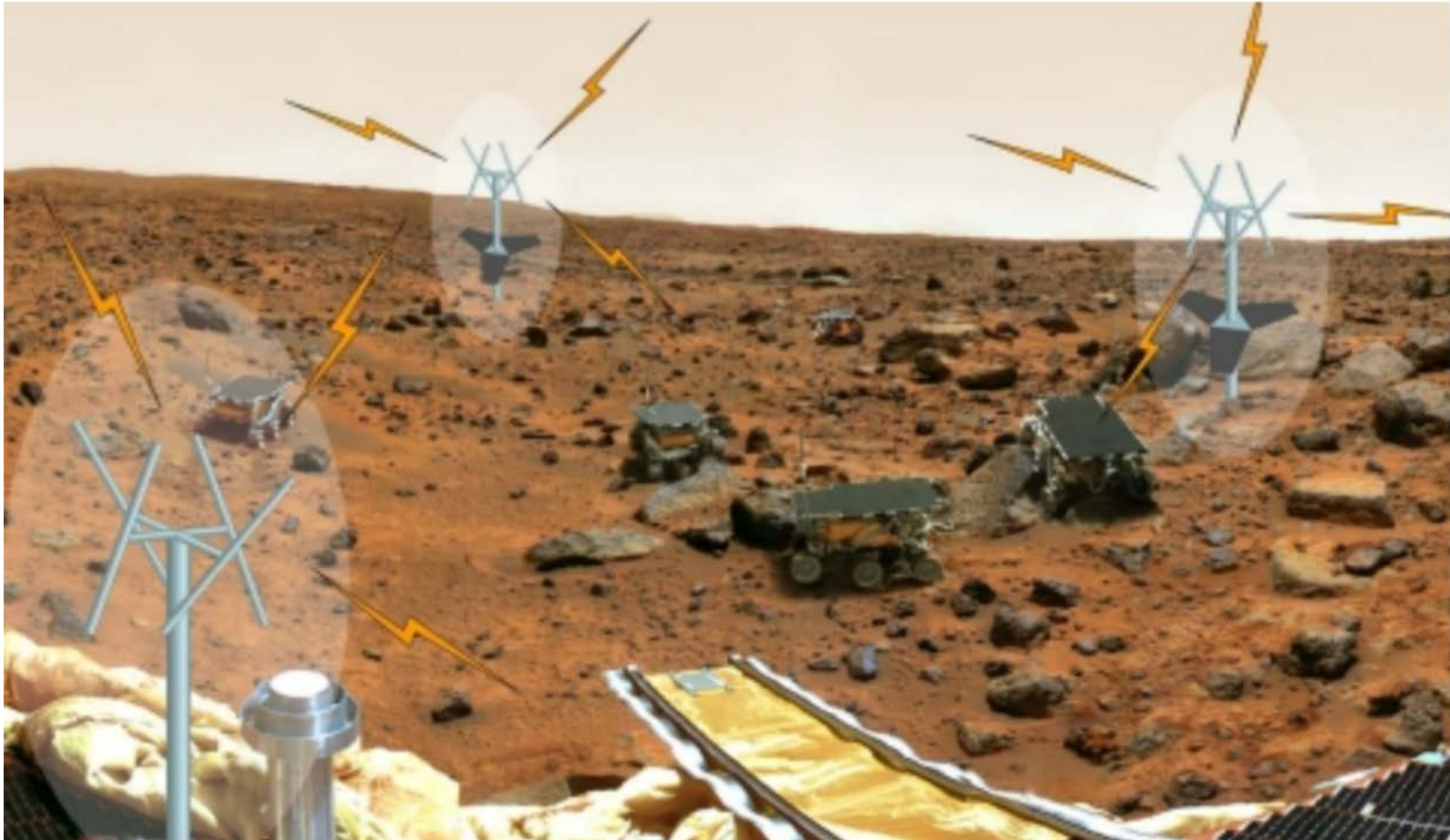

Figure C-3 Self-Calibrating Pseudolite Array

Note. From "ARL Projects", by Stanford University Aerospace Robotics Laboratory, 2005, *Mars Rover Navigation Using GPS Self-Calibrating Pseudolite Arrays*. Retrieved November 20, 2008, from <http://arl.stanford.edu/>



Figure C-4 Sniper Detection

Note. From "Robots That Make a Difference", by iRobot, 2008, *Missions for Ground Forces: Sniper Protection*, Copyright 2007 by iRobot. Retrieved November 20, 2008, from <http://www.irobot.com/sp.cfm?pageid=165>



**ROYAL CANADIAN AIR CADETS
PROFICIENCY LEVEL FOUR
INSTRUCTIONAL GUIDE**



SECTION 8

EO C440.06 – USE STAR CHARTS

Total Time:

60 min

PREPARATION

PRE-LESSON INSTRUCTIONS

Resources needed for the delivery of this lesson are listed in the lesson specification located in A-CR-CCP-804/PG-001, *Proficiency Level Four Qualification Standard and Plan*, Chapter 4. Specific uses for said resources are identified throughout the instructional guide within the TP for which they are required.

Review the lesson content and become familiar with the material prior to delivering the lesson.

Obtain a desktop globe for use in TP 2.

Obtain planisphere star charts and red-filtered flashlights for each cadet for use in TP 4.

Create slides of Attachments A and B.

Photocopy Attachment C for each cadet.

PRE-LESSON ASSIGNMENT

Nil.

APPROACH

An interactive lecture was chosen for TPs 1–3 to introduce the cadets to star charts and give an overview of the subject.

A demonstration and performance was chosen for TP 4 as it allows the instructor to explain and demonstrate planisphere use while providing an opportunity for the cadets to practice the skill under supervision.

INTRODUCTION

REVIEW

Nil.

OBJECTIVES

By the end of this lesson the cadet shall have used star charts to identify elements of the night sky.

IMPORTANCE

It is important for cadets to be able to use star charts because this knowledge enhances the enjoyment of amateur astronomy while contributing to an understanding of the aerospace challenge.

Teaching Point 1**Explain how the celestial sphere is divided.**

Time: 5 min

Method: Interactive Lecture

HOW EARTH AND SKY ARE ASSUMED TO BE CONCENTRIC

Celestial sphere. An imaginary sphere with the observer at its centre and celestial objects located on its inner surface.

Concentric. Having a common centre.

At first sight, the complexity of the night sky may seem bewildering. Familiarity with the night sky, as well as determining and describing the locations of celestial objects such as stars and galaxies, requires a standardized coordinate system. Such a system allows workers in the field to communicate celestial positions so that the observation can be repeated by others. For this purpose, a standardized coordinate system known as the celestial sphere was created. The celestial sphere is an optical illusion resulting from the inability to discern distance to stars making them all appear to be the same distance away. This imaginary sphere, therefore, is of infinite radius with the Earth located at its centre. The poles of the celestial sphere are aligned with the poles of the Earth. The celestial equator lies along the celestial sphere in the same plane that includes the Earth's equator. This is designed for the convenience of observers on Earth. The optical illusion of the celestial sphere can only be seen, in its orientation showing the classic constellations, from within the solar system.



Show the cadets the slide of Figure A-1 located at Attachment A.

When considering the celestial sphere it is convenient to assume that the sky is solid and that the celestial sphere is concentric with, or has the same centre as, the surface of the Earth.

CELESTIAL POLES

The north pole of the celestial sphere is the point directly above the Earth's north pole and the south pole of the celestial sphere is the point directly below the Earth's south pole. The North Celestial Pole (NCP) and the South Celestial Pole (SCP) are simply the north and south poles of the Earth extended into space.



Show the cadets the slide of Figure A-2 located at Attachment A.

The NCP passes very close to the star Polaris. As the Earth rotates around the NCP, Polaris is the only object in the sky that appears to stand still.

CELESTIAL EQUATOR

The celestial equator is the Earth's equator, but at a much greater radius. If the Earth's equator was a rubber band, then the celestial equator is the same rubber band just stretched away from the Earth, out to infinity.

CONFIRMATION OF TEACHING POINT 1**QUESTIONS:**

- Q1. What is the celestial sphere?
- Q2. What are the NCP and the SCP?
- Q3. Where is the celestial equator located?

ANTICIPATED ANSWERS:

- A1. The celestial sphere is an imaginary sphere of infinite radius with the Earth located at its centre.
- A2. The North Celestial Pole (NCP) and the South Celestial Pole (SCP) are simply the north and south poles of the Earth extended into space.
- A3. The celestial equator lies along the celestial sphere in the same plane of the Earth's equator.

Teaching Point 2**Explain how the sphere of the sky is represented on star charts.**

Time: 5 min

Method: Interactive Lecture

We can locate any object on the celestial sphere by giving it two coordinates, one called the object's declination and the other the object's right ascension. These are the object's celestial coordinates.



Show the cadets the slide of Figure A-1 located at Attachment A.

DECLINATION

The structure of the celestial coordinate lines is almost identical to that of the coordinates of the Earth's surface. To prevent confusion, the Earth's lines of latitude are re-labelled as "declination" lines when applied to the celestial sphere, but are numbered in degrees exactly the same as the Earth lines of latitude. However, to further avoid confusion, the celestial lines of declination are marked with a plus sign (+) in place of North and a minus sign (-) in place of South. Therefore, when a declination is shown as a negative number it is in the southern half of the celestial sphere.



Parts of the southern celestial sphere can be seen from Earth's northern hemisphere, especially during the northern hemisphere's winter months. The brightest star in the sky, Sirius, at minus 20 degrees, can be seen from Canada in the winter because, just as the northern hemisphere is inclined toward the North in the daytime, it is inclined toward the South in the nighttime.



Use a globe to show the cadets how the northern hemisphere in winter changes from northern daytime skies to southern nighttime skies as night falls.

RIGHT ASCENSION

To further prevent confusion, the longitude lines have been re-labelled as "right ascension" lines, and renumbered from 0 to 24 in hours. There is only an indirect connection to time here, even though hours, minutes and seconds are used to divide the angular distances between lines of right ascension. However, the celestial sphere, observed from the surface of Earth, is seen to complete one complete rotation overhead approximately once every 24 hours. Celestial rotation would be 24 hours exactly, if it were not for Earth's orbit around the Sun.

The right ascension of an object on the celestial sphere is measured along the celestial equator. By convention, 0 degrees is the point on the celestial equator where the Sun is found on the first day of spring (the vernal equinox).



Notice that 0 hours right ascension is unrelated to 0 degrees longitude. Using hours instead of degrees neatly avoids this conflict.

Stars and galaxies have (almost) fixed positions in right ascension and declination. The Sun and planets, on the other hand, move among the distant stars so that their coordinates change throughout the year. Due to the Earth's yearly orbital motion around the Sun, the Sun appears to circle the ecliptic.

THE PLANE OF THE ECLIPTIC

Plane of the ecliptic. The plane of the Earth's orbit around the Sun.

The plane of the ecliptic is an imaginary plane in which the Earth orbits the Sun. It is used as the primary reference plane when describing the position of bodies in the solar system.



Show the cadets the slide of Figure B-1 located at Attachment B.

Most objects in the solar system orbit in roughly this plane and in the same direction around the Sun as the Earth. There are exceptions such as many comets and a few minor planets (including the dwarf planet, Pluto), which have high inclinations, or tilt, compared to the reference plane—the plane of the ecliptic. Some comets even have retrograde orbits, such as Halley's comet, and orbit in the opposite direction to the planets.



Show the cadets the slide of Figure B-2 located at Attachment B.

The celestial sphere, viewed from Earth, shows the constellations that define the zodiac. The signs of the zodiac are the constellations that lie near the plane of the ecliptic and are visible at night in the months associated with these constellations.

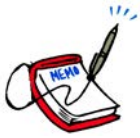

Ask the cadets what the approximate date is in Figure B-2 located at Attachment B.

CONFIRMATION OF TEACHING POINT 2

QUESTIONS:

- Q1. What are a celestial object's two coordinates called?
- Q2. On what is a celestial object's right ascension measured?
- Q3. What is the plane of the ecliptic?

ANTICIPATED ANSWERS:

- A1. Right ascension and declination.
- A2. The celestial equator.
- A3. The plane of the Earth's orbit around the Sun.

Teaching Point 3

Explain how to interpret a star chart.

Time: 5 min

Method: Interactive Lecture

A star chart is a map of the night sky. With it, you can identify and locate constellations and stars. A typical star chart shows the relative positions of the stars and their brightness.

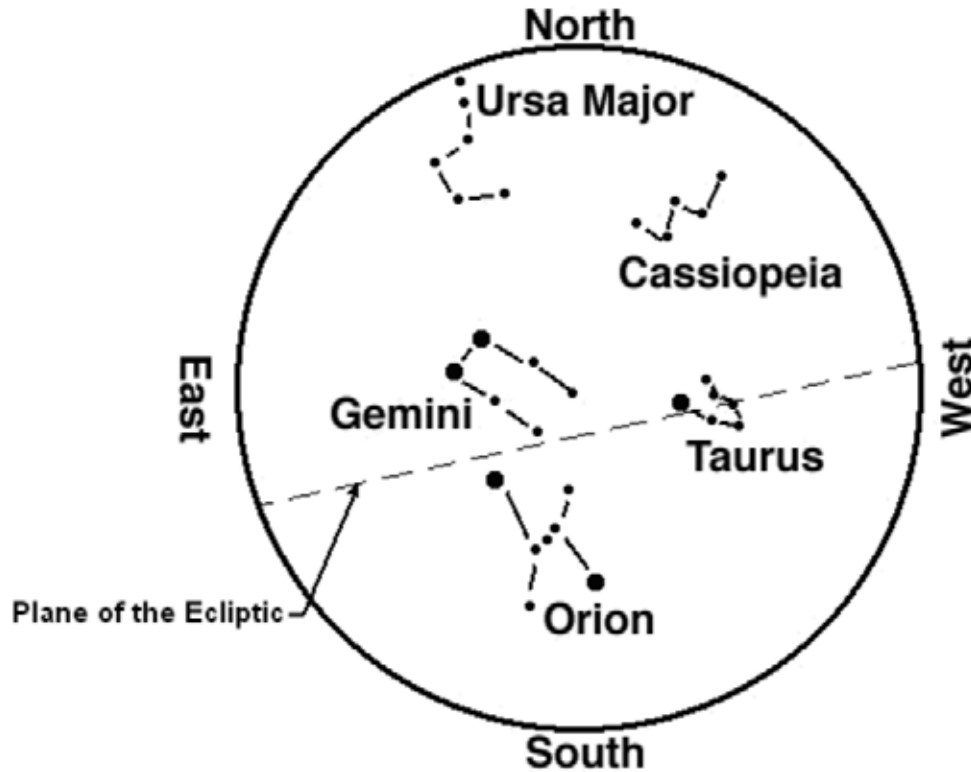

Figure 1 A Northern Hemisphere Spring Star Chart

Note. From "Astronomy Department at the University of Massachusetts", by T. Arny, 2002, *Using a Star Chart*, Copyright 2002, by T. Arny. Retrieved November 4, 2008, from http://www.astro.umass.edu/~arny/constel/constel_tutmod.html

DATE

A star chart is accurate only on a specific date because the night sky changes as Earth follows its orbit around the Sun. Also, planets move over a period of days.

TIME

A star chart will be correct for a very short time because celestial objects rise above the eastern horizon and follow a path overhead before finally setting in the West. Since different celestial objects are constantly rising and passing overhead and setting, a different set of celestial objects will occupy the sky at different times. The date and time of exact accuracy should be printed on the chart.

LATITUDE

An observer on the ground can only see the sky above the horizon. Different locations on the planet have different views of the sky. Although a patient observer can wait for a certain celestial object to rise in the East, and a celestial object with a certain right ascension will eventually appear if it is at an observable declination, there are celestial objects that are not in an observable declination for a given Earth latitude. For example, Polaris, the North Star, will never be seen from the Earth's South Pole. Therefore, a star chart has a property known as latitude and it will only show the sky that can be seen at the Earth latitude for which the star chart was prepared. The star chart's Earth latitude is printed on the star chart.

ORIENTATION

For orientation, a star chart is held overhead and turned until the direction the observer is facing appears at the bottom. If the observer is facing south, the star chart, when held overhead, should be turned until South is on

the bottom of the star chart. At this point, the pattern of celestial objects shown on the star chart will correspond to the pattern of celestial objects seen in the sky.

PLANETS

Planets add another layer of challenge to interpreting a star chart. Planets constantly change their position relative to fixed celestial objects.



Star charts can be retrieved from the Montreal Planetarium website:
<http://www.planetarium.montreal.qc.ca/Information/Documents/PDF/PocketPlanetariumV12N4.pdf> and other websites, such as <http://skymaps.com/downloads.html>

CONFIRMATION OF TEACHING POINT 3

QUESTIONS:

- Q1. What are two reasons that a star chart is accurate only on a specific date?
- Q2. Why is a star chart accurate only at a specific hour?
- Q3. For orientation, how is a star chart held?

ANTICIPATED ANSWERS:

- A1. The night sky changes as Earth follows its orbit around the Sun and planets constantly move.
- A2. The night sky changes as Earth rotates on its axis.
- A3. For orientation, a star chart is held overhead and turned until the direction the observer is facing appears at the bottom.

Teaching Point 4

Explain, demonstrate and have the cadets identify elements of the night sky by exploring aspects of a planisphere.

Time: 40 min

Method: Demonstration and Performance

Planisphere star chart. Analog computer for calculating the position of stars.



Distribute a planisphere star chart to each cadet.

A planisphere consists of two layers: a star map base and an overlay in which is set a clear oval window. The four steps to orienting a planisphere are as follows:

1. Locate the date, on the star map layer, on which the planisphere is to be used.
2. Rotate the overlay so that the time of use aligns with the date of use.
3. Identify North by locating the North Star.
4. The planisphere is then held above the user's head, map downward, with the middle of the oval window directly overhead and the midnight time mark toward the North.

The coordinates of a celestial object shown on a planisphere can be determined by reading the hours of right ascension from the outer edge of the star map base. Lines of right ascension run from the edge of the star map base to the centre of the star map base. A celestial object's declination can be determined by interpolating between the concentric declination lines which circle the star map base, with the celestial equator shown at 0 degrees—passing through constellation Orion at 6 hours right ascension.



Instruct the cadets on how to use the specific planisphere star chart according to directions provided with the planisphere.

Planispheres generally have the following characteristics:

- a. **Planisphere design.** A planisphere has this name because the celestial sphere is represented on a flat plane, such as paper. Since the Earth is constantly in motion, the time of day, time of year, and location influence the appearance of the sky. An individual star chart cannot accurately represent all of these combinations. This would take many different star charts. A preferable method is to use a planisphere star chart that allows the user to twist a dial to show the true position of the stars.
- b. **The lack of planetary data on a planisphere.** Since the planisphere is usable on any day, it cannot display planets because planets constantly move across the sky.
- c. **Date.** The visible night time stars and constellations change as the Earth revolves around the Sun. The summer sky is therefore different than the winter sky because the Earth is facing the opposite direction. Therefore, the correct date must be selected on the planisphere.
- d. **Time.** As the Earth turns on its axis, stars and constellations rise in the East and set in the West, just as the Sun does (the Sun is just one more star, but a close one). Therefore, the planisphere must be adjusted for correct time.
- e. **Midnight time mark.** When applying the planisphere to the night sky, the planisphere is oriented so that the midnight mark is to the North, after the time of day on the overlay is aligned with the date on the star map base.
- f. **Latitude.** Planispheres are specific to latitudes because each latitude allows a view of a different swath of the celestial sphere as the Earth rotates.
- g. **Orientation.** For constellations to appear in their correct location on the planisphere at the correct time, it is necessary to align the planisphere correctly with True North. When that is done, constellations that are rising in the East will be shown on the east edge of the planisphere. The planisphere consists of two layers: a star map base and an overlay in which is set a clear oval window.
- h. **Horizon.** The edges of the clear overlay window represent the viewer's approximate horizon.
- i. **Constellations.** On most planispheres, the names of constellations are printed in capital letters.
- j. **Stars.** On most planispheres, the names of stars are printed in lower case letters, except the first letter in the star's name, which is capitalized.

ACTIVITY

Time: 30 min

OBJECTIVE

The objective of this activity is to have the cadets identify elements of the night sky by exploring aspects of a planisphere.

RESOURCES

- Observation Record located at Attachment C,
- Planispheres, and
- Red-filtered flashlights.

ACTIVITY LAYOUT

- For the demonstration portion of this lesson, organize the cadets into a circle with the instructor as a member of the circle.
- For the performance portion of this lesson, the cadets keep within hearing distance of the instructor so the instructor can easily respond to questions.

ACTIVITY INSTRUCTIONS

1. Distribute a photocopy of Attachment C to each cadet.
2. Distribute one red-filtered flashlight per four cadets and have the cadets orient their planispheres.
3. Have the cadets locate celestial objects and constellations, using a planisphere.
4. Have the cadets determine the coordinates of celestial objects by reading declination and right ascension from the star base map of the planisphere, including interpolation between the coordinate lines.
5. Have the cadets record their observations of the celestial sphere on Attachment C.

SAFETY

Nil.

CONFIRMATION OF TEACHING POINT 4

The cadets' participation in identifying elements of the night sky by exploring aspects of a planisphere will serve as the confirmation of this TP.

END OF LESSON CONFIRMATION

QUESTIONS

- Q1. What is the celestial sphere?
- Q2. Why are planispheres specific to latitudes on Earth?
- Q3. Where does the name planisphere come from?

ANTICIPATED ANSWERS

- A1. The celestial sphere is an imaginary sphere of infinite radius with the Earth located at its centre.
- A2. Planispheres are specific to latitudes on Earth because each latitude allows a view of a different swath of the celestial sphere as the Earth rotates.
- A3. A planisphere has this name because the celestial sphere is represented on a flat plane, such as paper.

CONCLUSION

HOMEWORK / READING / PRACTICE

Nil.

METHOD OF EVALUATION

Nil.

CLOSING STATEMENT

Knowledge of how to use a star chart is very helpful in amateur astronomy and will aid in the identification of many celestial bodies that would otherwise be missed.

INSTRUCTOR NOTES / REMARKS

TPs 1–3 may be taught in the classroom or in the field, as appropriate.

Cadets who are qualified Advanced Aerospace may assist with this instruction.

REFERENCES

C3-176 ISBN 1-55407-071-6 Moore, P. (2005). *Atlas of the universe*. Richmond Hill: Firefly Books.

C3-179 ISBN 1-55209-302-6 Dickenson, T. (2001). *Night watch: A practical guide to viewing the universe*. Willowdale, ON: Firefly Books.

C3-180 ISBN 1-55297-853-2 Scagell, R. (2004). *Firefly planisphere: Latitude 42 deg N*. Willowdale, ON: Firefly Books.

C3-221 National Research Council of Canada. (2007). *Explore the night sky*. Retrieved December 3, 2007, from <http://www.nrc-cnrc.gc.ca/eng/education/astronomy/constellations/html.html>

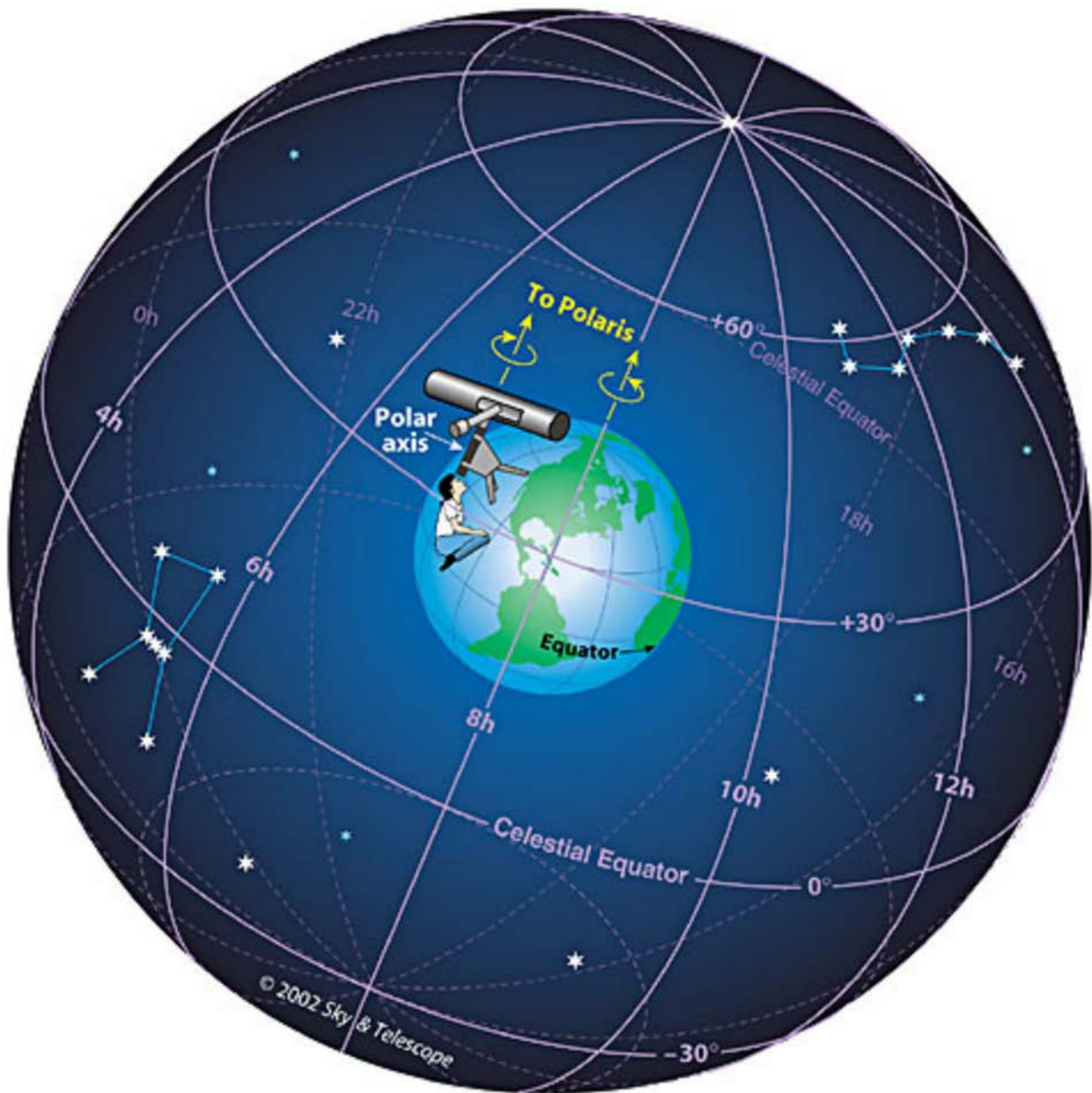

Figure A-1 Aligning With Polaris

Note. From "Sky and Telescope" by A. M. MacRobert, 2001, *Understanding Celestial Coordinates*. Retrieved October 30, 2008, from http://www.skyandtelescope.com/howto/basics/Celestial_Coordinates.htm



Figure A-2 Observing Polaris

Note. From "Sky and Telescope" by A. M. MacRobert, 2001, *Understanding Celestial Coordinates*.
Retrieved October 30, 2008, from http://www.skyandtelescope.com/howto/basics/Celestial_Coordinates.html

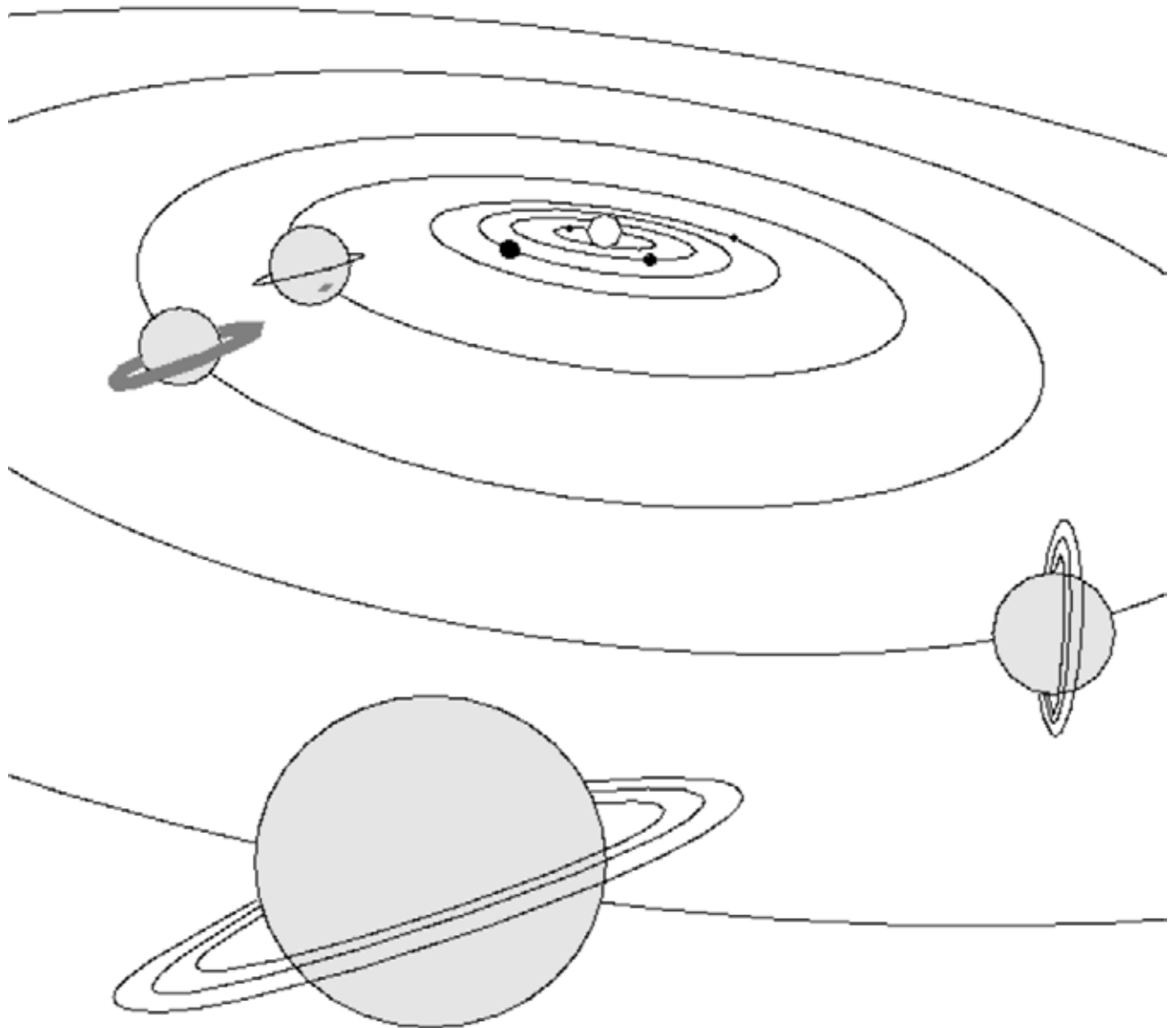

Figure B-1 Third Rock from the Sun

Note. From "CSE@SSL", by B. Napier, 1995, *Demonstration: The Plane of the Ecliptic*, Copyright 1995 by Regents of the University of California. Retrieved October 30, 2008, from <http://cse.ssl.berkeley.edu/img/eclip.gif>

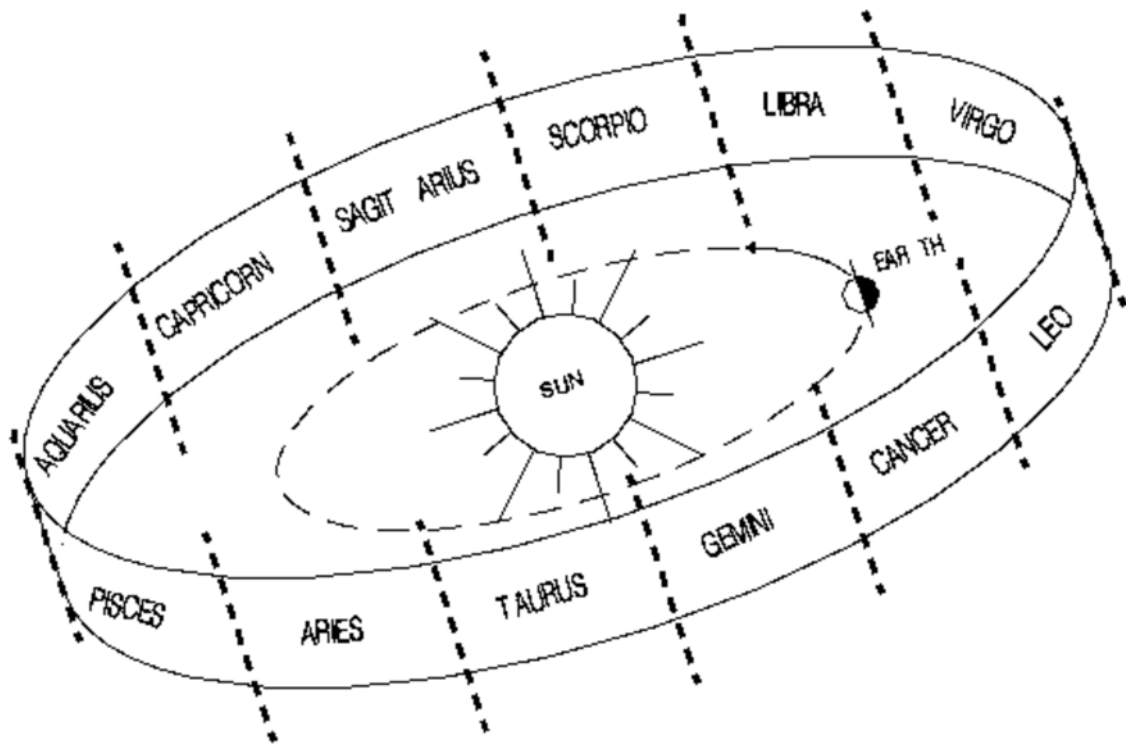

Figure B-2 The Zodiac and its Constellations

Note. From "CSE@SSL", by B. Napier, 1995, *Demonstration: The Plane of the Ecliptic*, Copyright 1995 by Regents of the University of California. Retrieved October 30, 2008, from http://cse.ssl.berkeley.edu/lessons/indiv/beth/beth_intro.html

Observation Record	
Date:	Time:
Place:	Instruments used:
Conditions:	
Observations:	

THIS PAGE INTENTIONALLY LEFT BLANK



**ROYAL CANADIAN AIR CADETS
PROFICIENCY LEVEL FOUR
INSTRUCTIONAL GUIDE**



SECTION 9

EO C440.07 – OPERATE A TELESCOPE

Total Time:	60 min
-------------	--------

PREPARATION

PRE-LESSON INSTRUCTIONS

Resources needed for the delivery of this lesson are listed in the lesson specification located in A-CR-CCP-804/PG-001, *Proficiency Level Four Qualification Standard and Plan*, Chapter 4. Specific uses for said resources are identified throughout the instructional guide within the TP for which they are required.

Review the lesson content and become familiar with the material prior to delivering the lesson.

Create slides of figures located at Attachments A and B.

Check that all equipment for TP 3 is serviceable prior to delivering the lesson.

Check the telescope's owner's manual for use procedures and modify the lesson as required.

PRE-LESSON ASSIGNMENT

Nil.

APPROACH

An interactive lecture was chosen for TPs 1 and 2 to orient the cadets to telescope theory and generate interest in the subject.

A demonstration and performance was chosen for TP 3 as it allows the instructor to explain and demonstrate the telescope-handling skills the cadets are expected to acquire while providing an opportunity for the cadets to practice the skill under supervision.

INTRODUCTION

REVIEW

Nil.

OBJECTIVES

By the end of this lesson the cadet shall be expected to operate manual and computerized telescopes.

IMPORTANCE

It is important for cadets to know how to operate telescopes because this provides a fascinating way to become personally involved with astronomy—an important aspect of aerospace development.

Teaching Point 1**Identify the parts of a telescope.**

Time: 10 min

Method: Interactive Lecture



Show the cadets Attachment A and use a telescope as an example, to show where the parts of a telescope are located.

Many telescopes have the following parts and accessories:

Optical tube. Forms the body of the telescope.

Optical tube mounts. These include:

- equatorial mount (one axis of movement on the Earth's equatorial plane), and
- altazimuth mount (two axes of movement—altitude and azimuth).

Finderscope. Used to orient the main telescope.

Eyepiece. Used to focus the gathered star light for the human eye.

Lens cover. Used to protect the telescope optics when stored.

Mirrors. Used to reflect and concentrate light.

Lens(es). Used to refract (or change the path of) light.

Focus knob. Used to focus the light in the telescope.

Tripod. Used to provide a firm, steady base for the telescope.

Specialty computerized telescope parts. These include:

- control panel,
- on / off switch,
- computer interface port, and
- power cord.

CONFIRMATION OF TEACHING POINT 1**QUESTIONS:**

- Q1. How many axes of movement does an equatorial mount have?
- Q2. What is the purpose of a finderscope?
- Q3. What is the purpose of a lens?

ANTICIPATED ANSWERS:

- A1. One axis of movement.
- A2. A finderscope is used to orient the main telescope.
- A3. A lens is used to refract (or change the path of) light.

Teaching Point 2**Describe telescope theory.**

Time: 10 min

Method: Interactive Lecture

SAFETY

An observer must never look at the sun through an unfiltered lens because the focused sunlight will seriously damage a human eye.

Telescopes are fragile equipment requiring careful handling. Rough handling will not only damage the telescope, but may break the glass.

WHAT THE NUMBERS REPRESENT**Light Gathering of Main Lens or Mirror (Aperture)**

The main lens or mirror of a telescope is referred to as the telescope's objective. The size of a telescope's objective determines the telescope's aperture. The larger the aperture of a telescope, the more light it can gather in a given unit of time. This not only makes certain features more visible to the human eye, it also shortens exposure times for celestial photography. A 30-cm (12-inch) main mirror produces images nine times brighter than a 10-cm (4-inch) mirror. Large telescopes are more difficult to move and handle, but smaller telescopes require longer exposure times for celestial photography.

Focal Length

Focal length is the distance that the main lens or mirror of a telescope takes to focus light to the point of focus. The longer the focal length, the larger the image at the focal point. This can be made up on a short focal length telescope, in most cases, by the magnification of the eyepiece. Although a long focal-length telescope produces a larger image at focus, it will also be fainter because the long focal path spreads out the light. During photography, when no eyepiece is used, a longer focal length is sometimes an advantage because it yields a larger image with comparable magnification.



The magnifying power of a telescope can be changed by changing the eyepiece (also referred to as the ocular). To determine the magnification of a telescope, divide the focal length of the telescope by the focal length of the eyepiece being used.

Focal Ratio

Focal ratio is the ratio of a telescope's focal length to the diameter of its main lens or mirror—its objective. Focal ratio is found by dividing focal length by objective diameter (aperture). A telescope with a mirror of 20 cm (8 inches) across and a focal length of 122 cm (48 inches) has a focal ratio of $f/6$. A telescope's focal length can be found by multiplying focal ratio by aperture, so that a telescope with a 20-cm (8-inch) aperture and $f/6$ ratio would have a focal length of 122 cm (48 inches).

Long focal lengths are considered to be in the $f/9$ or greater range. A telescope of a given diameter coupled with a short focal length produces bright images but wide fields. This is fine for observing large deep-sky objects and

star fields, but to photograph planets and binary stars, a longer focal length is superior because the planet's or binary's image is larger at the point of focus.

SEEING

Seeing refers to the steadiness of the image of a celestial object viewed through the telescope. Good seeing means a steady image, while bad seeing means an unsteady image. Binoculars, which typically have much less magnification, can tolerate greater shaking movement without degraded seeing. It is the image, which is viewed, that determines seeing.

Image Shaking

Any movement of the telescope while viewing will degrade seeing. Heavier tripods tend to provide a steadier base for a telescope and improve seeing. Spindly tripods tend to degrade seeing by allowing the telescope to shake during use.

Shimmering (Atmospheric Turbulence)

Turbulence in the Earth's atmosphere imparts a shimmering quality to telescope images. This is the same effect which makes stars appear to twinkle to the naked eye. The intensity of the turbulence depends on winds, the temperature differential among upper-atmosphere layers and the local topography and air circulation immediately around the telescope. The larger the diameter of the telescope, the more it is affected, because large telescopes have to peer through more air than smaller ones do. A telescope with a main lens or mirror 20 cm (8 inches) in diameter must look through a column of air 20 cm (8 inches) wide and about 16 km (10 miles) long.

THREE MAIN TYPES OF TELESCOPE OPTICAL SYSTEMS

Refractor Telescope

Although the classic design of the refractor has undergone significant changes since Galileo's time, the principle is still the same.

A main lens composed of two or more different pieces of optically figured glass brings light to a focus at the opposite end of the tube. Refractors have the advantage of rendering sharp high-contrast images, large image scales (due to higher focal ratios) and excellent resolution.

Newtonian Reflector Telescope

Since its invention by Sir Isaac Newton in 1668, the reflector telescope has been very popular with amateur astronomers. It consists of a concave mirror positioned at the bottom of the tube that reflects and focuses starlight to a point just inside the tube's entrance. A flat secondary mirror redirects the light out the side of the tube and into an eyepiece lens.

Newtonian reflector telescopes provide accurate colour rendition of celestial objects and are less expensive for a given objective size than refractors. A 20-cm (8-inch) reflector costs about the same as a modest 10-cm (4-inch) refractor.

Schmidt-Cassegrain Telescope

Telescopes that employ the features of both refractors and reflectors are said to be catadioptric. One of the most popular catadioptric designs is the Schmidt-Cassegrain telescope (SCT).

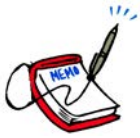

Show the cadets Attachment B.

The SCT has a spherical primary mirror at one end of the tube and a correcting lens at the other. The secondary mirror is mounted directly onto the correcting lens (or plate). This, in turn, redirects the light back down the tube and through a hole in the centre of the main mirror, where the eyepiece is located.

Folding the light path allows a manufacturer to produce a telescope with a focal length that is twice the length of the tube. Thus, SCTs are lightweight, portable, and produce excellent images.

CONFIRMATION OF TEACHING POINT 2

QUESTIONS:

- Q1. Why must one never look at the sun through an unfiltered lens?
- Q2. What is seeing?
- Q3. What are three advantages of SCTs?

ANTICIPATED ANSWERS:

- A1. Focused sunlight will seriously damage a human eye.
- A2. Seeing refers to the steadiness of the image of a celestial object viewed through the telescope.
- A3. SCTs are lightweight, portable, and produce excellent images.

Teaching Point 3

Explain, demonstrate and have the cadets set up, operate and dismantle a telescope.

Time: 30 min

Method: Demonstration and Performance



For this skill TP, it is recommended that instruction take the following format:

1. Explain and demonstrate the complete skill while cadets observe.
2. Explain and demonstrate each step required to complete the skill. Monitor cadets as they imitate each step.
3. Monitor the cadets' performance as they practice the complete skill.

Note: Assistant instructors may be employed to monitor the cadet's performance.

1. To set up a telescope:
 - a. remove all parts from their containers, ensuring that the optical tube is placed on a sturdy level surface;
 - b. set up the tripod;
 - c. attach the telescope to the tripod;

- d. attach the finderscope (if required);
 - e. attach the eyepiece (if required);
 - f. align the finderscope; and
 - g. align the telescope.
2. To operate and dismantle a telescope:
- a. adjust the right ascension;
 - b. adjust the declination;
 - c. remove the eyepiece (if required);
 - d. remove the finderscope (if required);
 - e. remove the telescope from its tripod;
 - f. collapse the tripod; and
 - g. return all parts to their containers.

Cadets must be careful when handling fragile equipment.

CONFIRMATION OF TEACHING POINT 3

The cadets' participation in setting up, operating and dismantling telescopes will serve as the confirmation of this TP.

END OF LESSON CONFIRMATION

QUESTIONS:

- Q1. How many axes of movement does an altazimuth mount have?
- Q2. Who invented the Newtonian reflector telescope design and in what year was it invented?
- Q3. What does folding the light path in a SCT allow the manufacturer to do?

ANTICIPATED ANSWERS:

- A1. Altazimuth mounts have two axes of movement.
- A2. Sir Isaac Newton in 1668.
- A3. Folding the light path allows a manufacturer to produce a telescope with a focal length that is twice the length of the tube.

CONCLUSION

HOMEWORK / READING / PRACTICE

Nil.

METHOD OF EVALUATION

Nil.

CLOSING STATEMENT

Knowing how to operate telescopes provides a fascinating way to become personally involved with an important aspect of aerospace development.

INSTRUCTOR NOTES / REMARKS

Cadets who are qualified Advanced Aerospace may assist with this instruction.

REFERENCES

C3-179 ISBN 1-55209-302-6 Dickenson, T. (2001). *Night watch: A practical guide to viewing the universe*. Willowdale, ON: Firefly Books.

C3-286 11073-INST. Celestron. (2006). *CPC series instructional manual*. Torrance, CA: Celestron.

THIS PAGE INTENTIONALLY LEFT BLANK



1	Control Panel (see below)	8	Optical Tube
2	Focus Knob	9	Schmidt Corrector Lens
3	Star Diagonal	10	Fork Arm
4	Hand Control	11	Carrying Handle
5	Eyepiece	12	Right Ascension Locking Knob
6	Finderscope	13	Tripod
7	Finderscope Quick Release Bracket	14	Accessory Tray / Center Support Bracket
A	Hand Control Port	D	Auto Guider Port
B	Auxiliary Ports	E	On/Off Switch
C	PC Interface Port	F	12v Input Jack

Figure A-1 Celestron Telescope

Note. From Celestron®, 2006, CPC™ Series Instructional Manual. Copyright 2006 by Celestron, Torrance, CA: Celestron.

THIS PAGE INTENTIONALLY LEFT BLANK

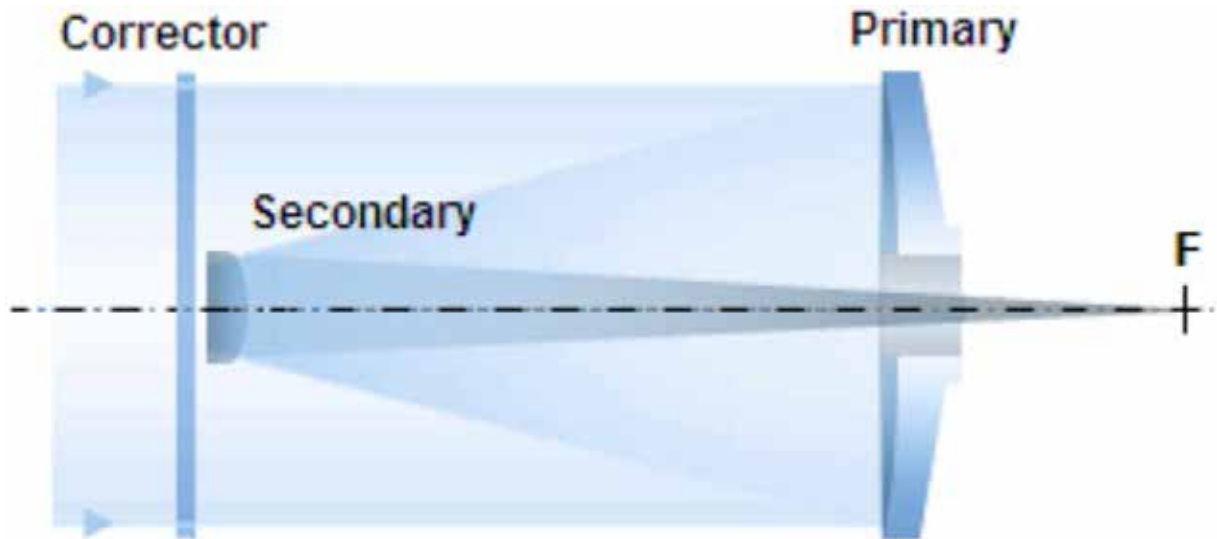

Figure B-1 Schmidt-Cassegrain Telescope Design

Note. From "telescopeOptics.net", by Vladimir Sacek, 2006, *Schmidt-Cassegrain Telescope (SCT)* Retrieved October 15, 2008, from <http://www.telescope-optics.net/SCT.htm>.

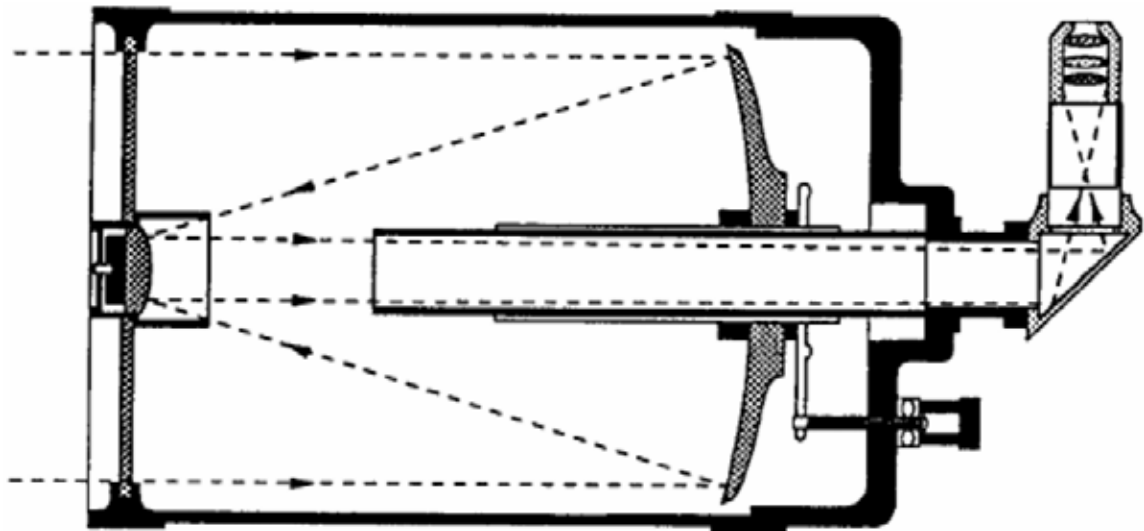

Figure B-2 Celestron SCT

Note. From Celestron®, 2006, *CPC™ Series Instructional Manual*. Copyright 2006 by Celestron, Torrance, CA: Celestron.

THIS PAGE INTENTIONALLY LEFT BLANK



**ROYAL CANADIAN AIR CADETS
PROFICIENCY LEVEL FOUR
INSTRUCTIONAL GUIDE**



SECTION 10

**EO C440.08 – WATCH *BLAST!* (BALLOON-BORNE
LARGE APERTURE SUB-MILLIMETRE TELESCOPE)**

Total Time: 90 min

PREPARATION

PRE-LESSON INSTRUCTIONS

Resources needed for the delivery of this lesson are listed in the lesson specification located in A-CR-CCP-804/PG-001, *Proficiency Level Four Qualification Standard and Plan*, Chapter 4. Specific uses for said resources are identified throughout the instructional guide within the TP for which they are required.

Review the lesson content and become familiar with the material prior to delivering the lesson.

Create slides of the figures located at Attachments A and B.

Photocopy Attachment C for each cadet.

PRE-LESSON ASSIGNMENT

Nil.

APPROACH

An interactive lecture was chosen for TP 1 to introduce the cadets to cosmology and give an overview of the BLAST mission.

An in-class activity was chosen for TP 2 as it is an interactive way to reinforce cosmology, provoke thought and stimulate interest among cadets.

A group discussion was chosen for TP 3 as it allows the cadets to interact with their peers and share their knowledge, experiences, opinions, and feelings about cosmology using a balloon-borne large aperture sub-millimetre telescope.

INTRODUCTION

REVIEW

Nil.

OBJECTIVES

By the end of this lesson the cadet shall be expected to discuss the professional challenges that astrophysicists faced in the BLAST mission.

IMPORTANCE

It is important for cadets to discuss the professional challenges that astrophysicists face so that they understand how astrophysics is influenced by aerospace technologies.

Teaching Point 1**Describe the BLAST mission.**

Time: 10 min

Method: Interactive Lecture



The word sub-millimetre, as it is used in this lesson, refers to the proximate wavelength of near-infrared electromagnetic energy, which can be thought of as the warmth of the sun. Most animals see the sun at visible wavelengths but they feel the sun in the far-infrared. Sub-millimetre near-infrared energy is blocked by atmospheric water vapour.

OBSERVATION OF STAR FORMATION

Astrophysicists are interested in learning more about how the earliest galaxies and stars were formed. However, these objects are often hidden by gas and dust so they cannot be seen in visible light. Fortunately, star births are fiery events. Heat from the newborn stars warms the surrounding dust, which then emits sub-millimetre radiation—a form of infrared electromagnetic radiation close to visible light. Infrared radiation, having wavelengths that are longer than visible light, can pass through dusty regions of space without being scattered. In order to detect much of this radiation, however, sub-millimetre telescopes must be built.

Water vapour in the Earth's atmosphere absorbs radiation across large parts of the infrared and sub-millimetre wavebands, making ground-based observations at some of these wavelengths impossible. Limited observations can be made from high-altitude balloons, such as BLAST, but space-based observatories such as the European Space Agency's Herschel are the only truly satisfactory solution to this problem.



Show the cadets the slide of Figure A-1 located at Attachment A.

OBSERVATION OF GALAXY FORMATION

When astronomers look further out into space, they are actually looking further back in time. Light travels incredibly fast and seems instantaneous at short distances on the Earth, but light from distant galaxies takes millions or even billions of years to reach Earth. The further out one looks into space, the longer that light has travelled. Observers are literally seeing the light of events that happened in the remote past. Looking further and further back, astronomers can develop a timeline for the evolution of the universe.



Show the cadets the slide of Figure A-2 located at Attachment A.



Learn more about infrared astronomy in The Cosmic Classroom: The Infrared Universe at <http://coolcosmos.ipac.caltech.edu/>

THE BLAST MISSION DESIGN



Key words:

Bolometers. The sensors that detect sub-millimetre light.

Gondola. The large metal structure that holds the telescope, motors, and computers.

Payload. Anything dangling from the balloon.

Star cameras. Cameras that BLAST uses to orient itself in the sky.

Large unmanned helium balloons have long provided NASA with an inexpensive means to place payloads into a near-space environment. The unique capabilities of this program are crucial for the development of new technologies and payloads for NASA's space flight missions. They also offer essential training for the next generation of scientists, as can be seen in *BLAST!* As well, many important scientific observations are made from long-duration balloon flights.

BLAST used the Sun's energy to power instruments and took advantage of the Sun's continuous presence during the summers at the North and South Poles. Flying only in constant daylight, BLAST was ensured a steady source of power and a flight at a stable altitude. If the Sun were to set during the flight, the helium in a balloon would cool and it would drop to a lower altitude. At sunrise, the helium would heat and the balloon would rise.

BLAST needed a way to orient itself and point the telescope in the right direction. Although it had an onboard Global Positioning System (GPS), BLAST relied on the stars for its navigation. On top of the main mirror are two star cameras (long white tubes). These cameras took pictures of stars whose positions in the sky are well known. BLAST's computers then analyzed these reference points and, through a series of motors and gyroscopes, adjusted its orientation accordingly.

When landing, a remote-controlled system separated BLAST from the balloon and a parachute opened to help slow the telescope's descent. It took about 45 minutes for BLAST to reach the ground. The parachute was designed to then detach itself from the gondola. The precious hard drive, containing all of the data, had to be physically recovered. Recovery could be very difficult, depending on where BLAST landed.

In 2005, BLAST flew from Sweden to Canada while making moderately successful observations.



Show the cadets the slide of Figure B-1 located at Attachment B.

In 2006, BLAST flew over Antarctica while making very successful observations.



Show the cadets the slide of Figure B-2 located at Attachment B.

CONFIRMATION OF TEACHING POINT 1**QUESTIONS:**

- Q1. Why are sub-millimetre telescopes, which observe infrared radiation, needed for studying star formation?
- Q2. Why must sub-millimetre telescopes operate in or near space?
- Q3. How long did it take BLAST to descend to the ground on its parachute?

ANTICIPATED ANSWERS:

- A1. Infrared radiation has wavelengths that are much longer than visible light, so it can pass through the dusty regions of space where stars are formed without being scattered.
- A2. Water vapour in the Earth's atmosphere absorbs radiation across large parts of the infrared and sub-millimetre wavebands, making ground-based observations at some of these wavelengths impossible.
- A3. It took about 45 minutes for BLAST to reach the ground.

Teaching Point 2**Have the cadets watch *BLAST!***

Time: 55 min

Method: In-Class Activity

ACTIVITY**OBJECTIVE**

The objective of this activity is to have the cadets watch the 53-minute motion picture *BLAST! (Balloon-Borne Large Aperture Sub-Millimetre Telescope)*.

RESOURCES

- *BLAST!* DVD, and
- Handout of Attachment C.

ACTIVITY LAYOUT

Nil.

ACTIVITY INSTRUCTIONS

1. Distribute Attachment C to each cadet.
2. Instruct the cadets to consider the questions posed on the handout while watching *BLAST!*
3. Play the entire 53-minute motion picture *BLAST! (Balloon-Borne Large Aperture Sub-Millimetre Telescope)*.

SAFETY

Nil.

CONFIRMATION OF TEACHING POINT 2

The cadets' participation in the activity will serve as the confirmation of this TP.

Teaching Point 3

Discuss the science and the design of the BLAST mission.

Time: 15 min

Method: Group Discussion

BACKGROUND KNOWLEDGE

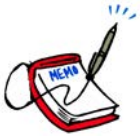

The point of the group discussion is to draw the following information from the group using the tips for answering / facilitating discussion and the suggested questions provided.

The background knowledge for this discussion is to be based on TP 1 and the material in the motion picture *BLAST! (Balloon-Borne Large Aperture Sub-Millimetre Telescope)*.

GROUP DISCUSSION



TIPS FOR ANSWERING / FACILITATING DISCUSSION:

- Establish ground rules for discussion, eg, everyone should listen respectfully; don't interrupt; only one person speaks at a time; no one's ideas should be made fun of; you can disagree with ideas but not with the person; try to understand others as much as you hope they understand you; etc.
- Sit the group in a circle, making sure all cadets can be seen by everyone else.
- Ask questions that will provoke thought; in other words avoid questions with yes or no answers.
- Manage time by ensuring the cadets stay on topic.
- Listen and respond in a way that indicates you have heard and understood the cadet. This can be done by paraphrasing their ideas.
- Give the cadets time to respond to your questions.
- Ensure every cadet has an opportunity to participate. One option is to go around the group and have each cadet answer the question with a short answer. Cadets must also have the option to pass if they wish.
- Additional questions should be prepared ahead of time.

SUGGESTED QUESTIONS:

- Q1. What are the main features of the professional relationship between the graduate student responsible for the Star Cameras and her two professors?
- Q2. Other than geography, what important similarities and links are there between Shackleton's missions and the BLAST mission?
- Q3. Why is it so important for visitors to McMurdo Station to be physically qualified (PQ)?
- Q4. How might a better understanding of the early universe affect everyday life?



Other questions and answers will develop throughout the group discussion. The group discussion should not be limited to only those suggested.



Reinforce those answers given and comments made during the group discussion, ensuring the teaching point has been covered.

CONFIRMATION OF TEACHING POINT 3

The cadets' participation in the group discussion will serve as the confirmation of this TP.

END OF LESSON CONFIRMATION

The cadets' participation in watching and discussing *BLAST!* will serve as the confirmation of this lesson.

CONCLUSION**HOMEWORK / READING / PRACTICE**

Nil.

METHOD OF EVALUATION

Nil.

CLOSING STATEMENT

Astrophysicists face daunting challenges while pushing back the frontiers of science. Fortunately, the tools and the constant development of aerospace technologies allow scientific research to progress.

INSTRUCTOR NOTES / REMARKS

It is recommended that this EO be presented in three consecutive periods.

If EO C440.07 (Operate a Telescope) is selected, it is recommended that it be presented prior to this lesson.

REFERENCES

C3-295 Devlin, P. (Producer & Director). (2008). *BLAST!* [Motion picture]. United States: The ArtistShare Project.

C3-298 *BLAST (Balloon-Borne Large Aperture Sub-Millimetre Telescope)*. University of Pennsylvania Department of Physics and Astronomy. Retrieved January 30, 2009, from <http://blastexperiment.info/>

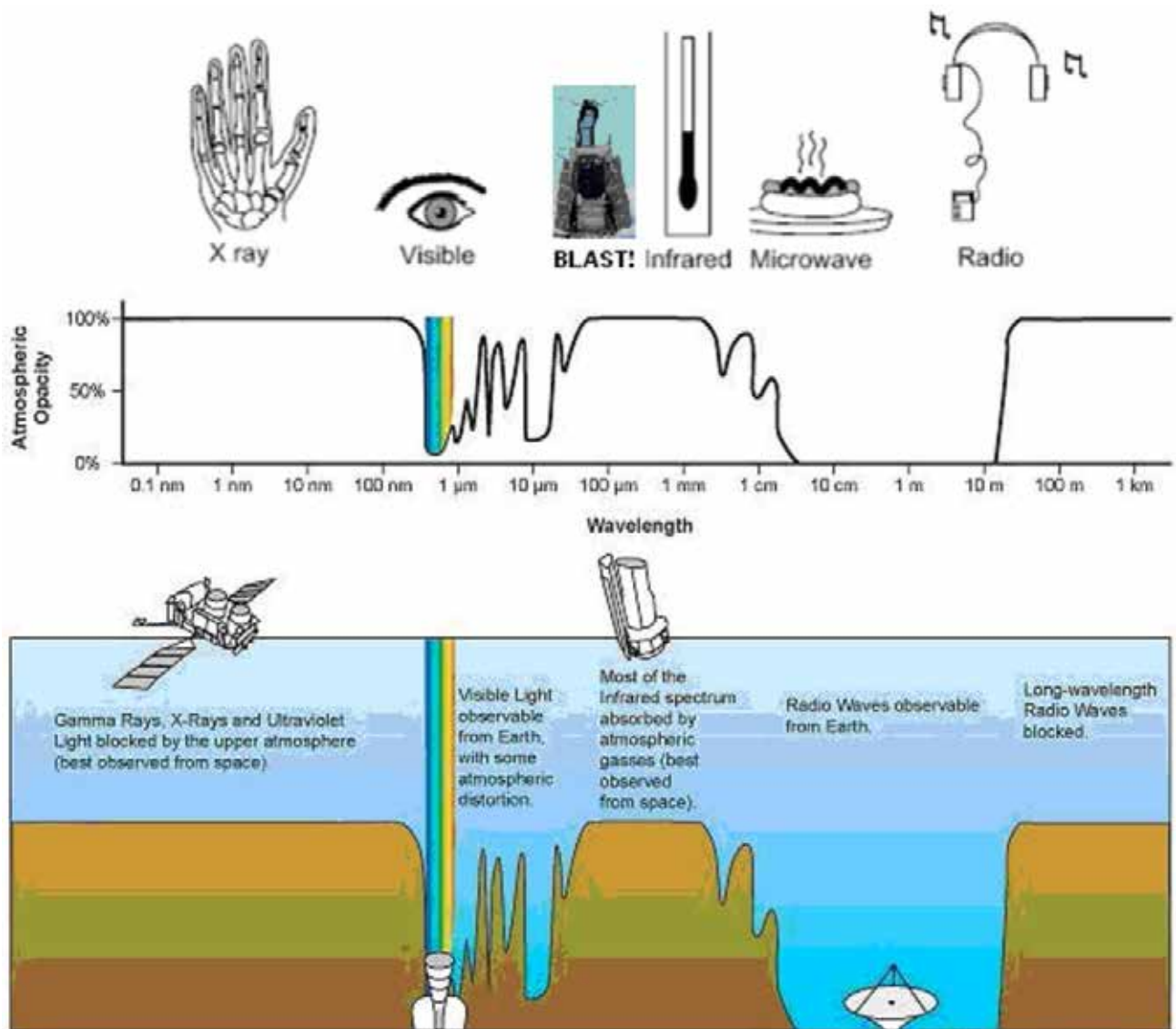

Figure A-1 The Electromagnetic Spectrum and Atmospheric Opacity

Note. From "Infrared Windows", *The Cosmic Classroom*, by California Institute of Technology, 2009. Retrieved March 27, 2009, from <http://www.ipac.caltech.edu/Outreach/Edu/Windows/irwindows.html>

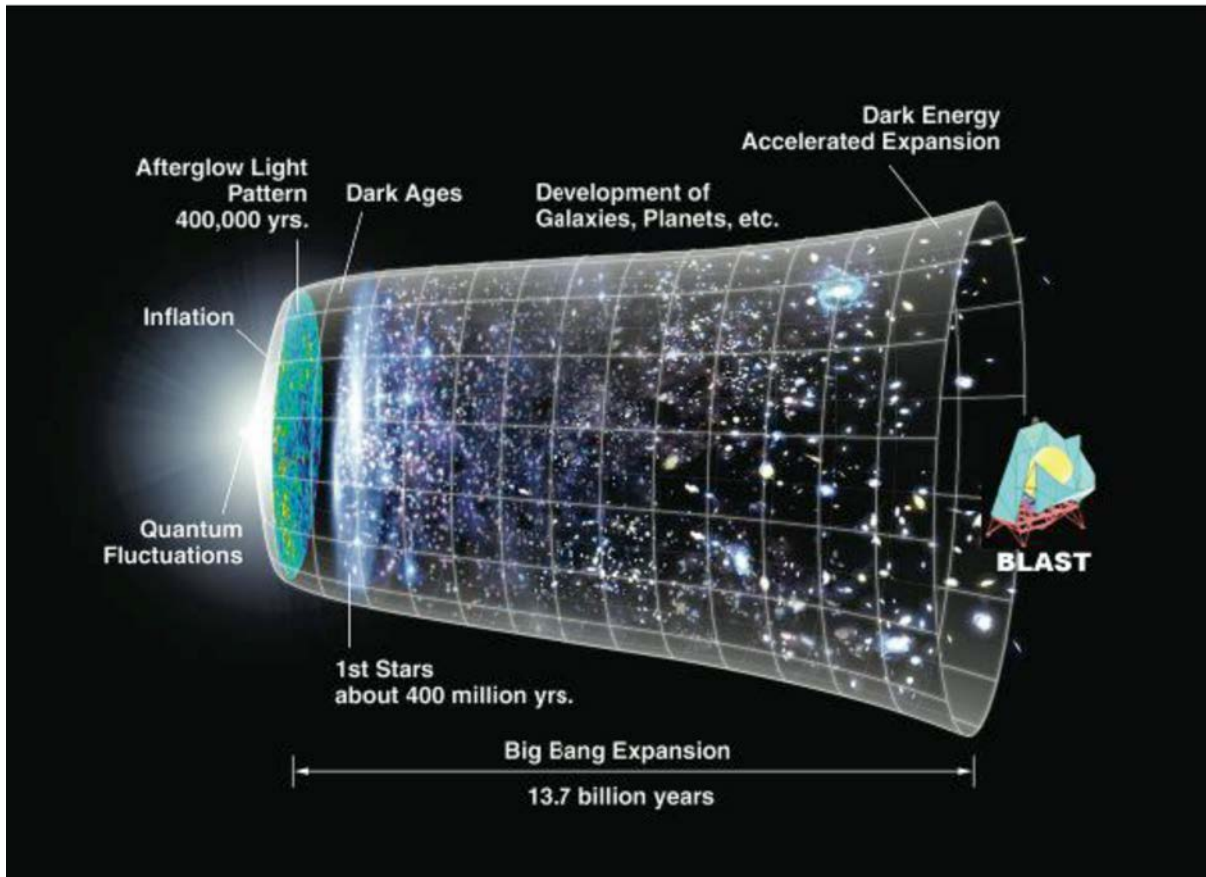

Figure A-2 The Big Bang

Note. From "BLAST: How It Works", *The Importance of BLAST*, by the ArtistShare Project, 2009. Retrieved March 28, 2009, from http://www.blastthemovie.com/press/BLAST_HowItWorks.pdf

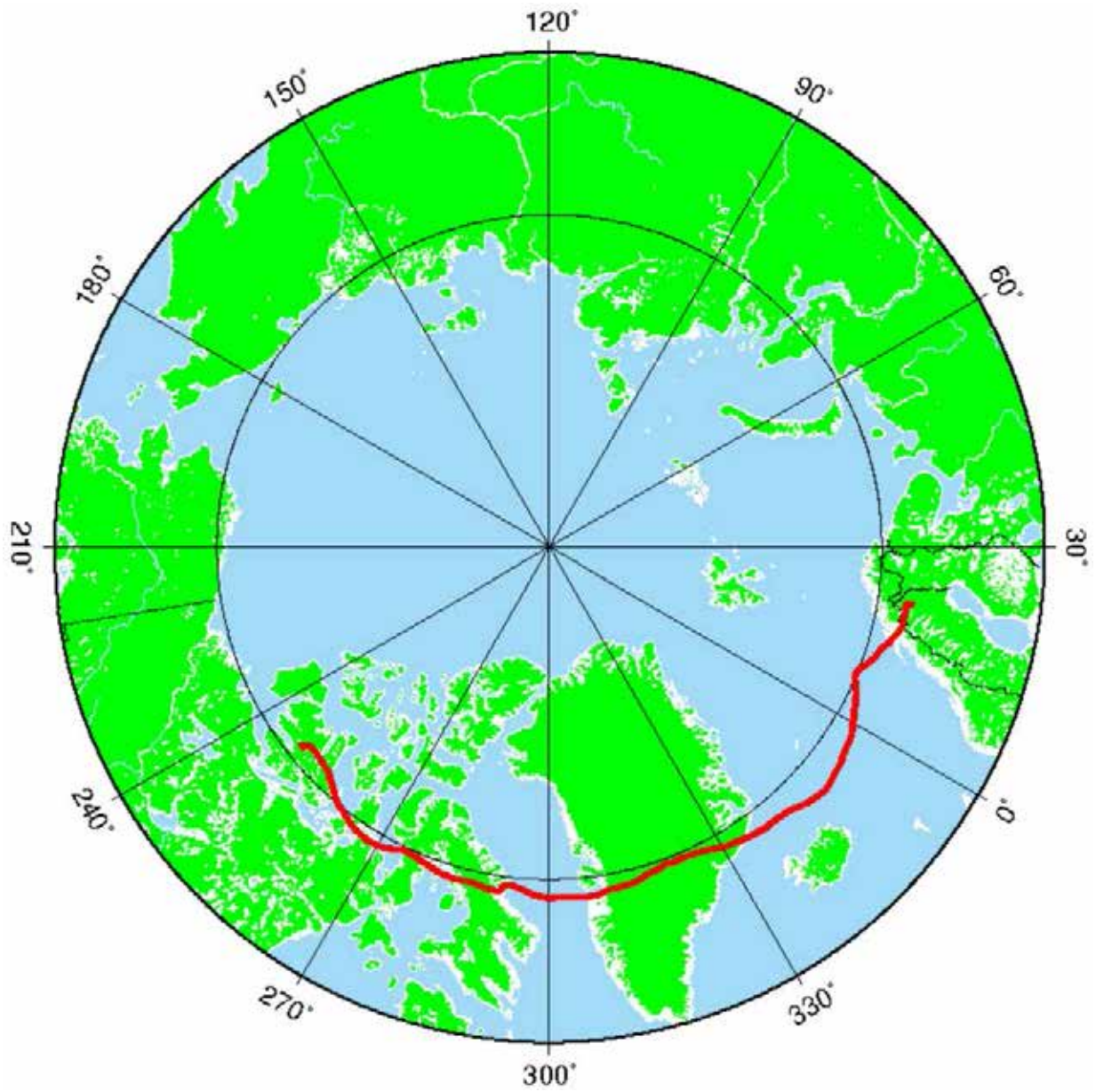

Figure B-1 BLAST Path 2005

Note. From "Flight Trajectory", *BLAST*, by Swedish Space Corporation, 2009. Retrieved March 28, 2009, from <http://www.ssc.se/?id=7082>

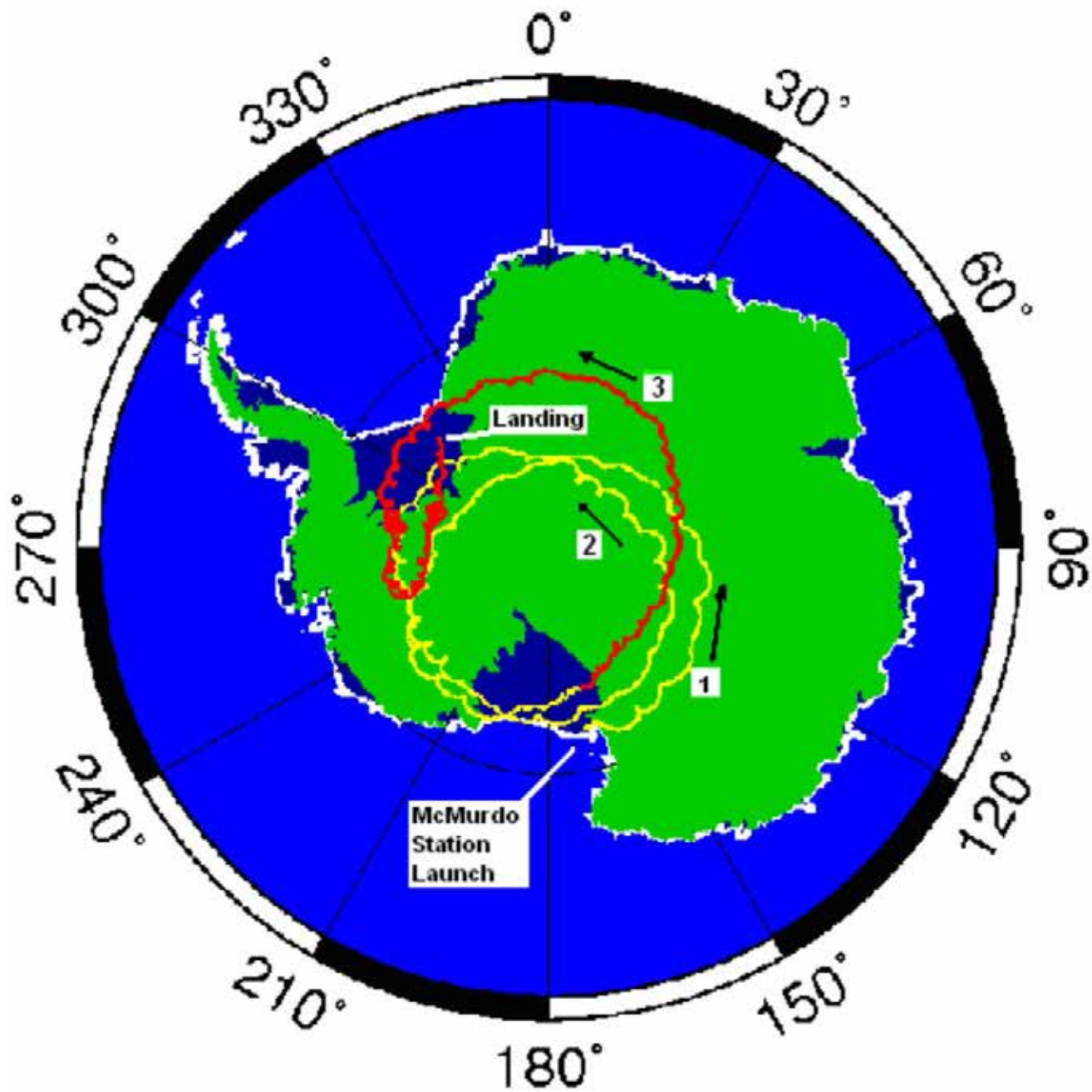

Figure B-2 BLAST Path 2006

Note. From "Flight Trajectory", *BLAST*, by Swedish Space Corporation, 2009.
Retrieved March 28, 2009, from <http://www.nsbf.nasa.gov/map/balloon4/balloon4.png>

QUESTIONS TO CONSIDER WHILE WATCHING *BLAST!*

- What advantages are there in doing balloon missions during the Arctic and Antarctic summers?
- What is the nature of the professional relationship between graduate students and professors?
- Why do scientists attach great importance to priority—being the first to publish new knowledge?
- How might the European Space Agency's Herschel space telescope benefit from a balloon-based test of its cutting-edge infrared bolometers?
- Why do countries such as Canada and institutions such as York University see great value in this expensive pure science, which concerns events that happened billions of light-years away and billions of years ago?

THIS PAGE INTENTIONALLY LEFT BLANK



ROYAL CANADIAN AIR CADETS
PROFICIENCY LEVEL FOUR
INSTRUCTIONAL GUIDE



SECTION 11

EO C440.09 – DESCRIBE THE RELATIONSHIP BETWEEN GRAVITY AND SPACE-TIME

Total Time: 60 min

PREPARATION

PRE-LESSON INSTRUCTIONS

Resources needed for the delivery of this lesson are listed in the lesson specification located in A-CR-CCP-804/PG-001, *Proficiency Level Four Qualification Standard and Plan*, Chapter 4. Specific uses for said resources are identified throughout the instructional guide within the TP for which they are required.

Review the lesson content and become familiar with the material prior to delivering the lesson.

Obtain and cue the following six Windows Media Video (WMV) files from Reference C3-312 located at <http://einstein.stanford.edu/index.html>

- WMV file *Newtons_Universe_Anima*,
- WMV file *Einsteins_Universe_Anima*,
- WMV file *Rel_gyro_expt-anima*,
- WMV file *SConSquid*,
- WMV file *Simple_expt_anima*, and
- WMV file *DF-Satellite*.

Create slides of figures located at Attachment A.

Photocopy the Gravity and Space-Time handout located at Attachment B for each cadet.

Obtain a copy of Reference C3-310, *Gravity Probe B: An Educator's Guide*.

Obtain and cue the *Testing Einstein's Universe* DVD.

Obtain a large round coin, such as a Canadian two-dollar piece, for use in TP 2.

PRE-LESSON ASSIGNMENT

Nil.

APPROACH

An interactive lecture was chosen for TPs 1 and 2 to introduce theories of gravitation and give an overview of the Gravity Probe B mission.

An in-class activity was chosen for TPs 3 and 4 as it as it is an interactive way to reinforce the relationship between gravity and space-time, provoke thought, and stimulate interest among cadets.

INTRODUCTION

REVIEW

Nil.

OBJECTIVES

By the end of this lesson the cadet shall be expected to describe the relationship between gravity and space-time.

IMPORTANCE

It is important for cadets to describe the relationship between gravity and space-time because viewing gravity as a curvature of space-time explains more phenomena in the aerospace environment than the classical Newtonian view of gravity as a force of attraction.

Teaching Point 1**Compare early ideas of gravity to gravitation under the theory of relativity.**

Time: 10 min

Method: Interactive Lecture

NEWTON'S UNIVERSAL LAW OF GRAVITATION

Show the cadets the WMV file *Newtons_Universe_Anima*.
Running time is 1 minute, 8 seconds.

GRAVITY AS A FORCE BETWEEN MASSES

According to Newton's theory of gravity, all bodies possess the force of attraction called gravity. Larger masses, such as the Sun, attract smaller masses, such as the planets and comets, more strongly, causing the smaller masses to move toward the larger masses. In our solar system, the planets orbit the Sun due to the force of the Sun's gravity pulling them into this elliptical path. Comets soaring through the galaxy are curved toward the Sun due to gravity's pull.

INSTANTANEOUS TRANSMISSION OF GRAVITY

In *Principia* (1687), Newton stated, "there is a power of gravity pertaining to all bodies, proportional to the several quantities of matter which they contain." However, when Newton was questioned about how this "power of gravity" transmitted from one body to another, he responded, "I make no hypothesis."

Einstein, along with other scientists, began to question this conclusion around the turn of the 20th century. In the 19th century, Maxwell had shown that light propagated at a finite rate in a vacuum; 299 792 km / sec (185 871 miles / sec). In 1905, Einstein's theory of special relativity was based on the idea that this rate was the speed limit for all matter and energy in the universe. If gravity was a force that transmitted between masses in the same way light propagated through space, the force of gravity should be equally restricted to 299 792 km / sec. While moving nearly 300 000 km each second is extremely fast, it is not instantaneous.

THE INTERDEPENDENCE OF SPACE AND TIME

Newton believed that space and time were absolute or fixed entities and that gravity could be represented as an attractive force that somehow acted instantaneously between objects. Einstein determined that space and time are relative entities, interwoven into a "fabric," which he called space-time, and he realized that no force—not even gravity—could act faster than the speed of light. In Einstein's universe, the presence of celestial bodies causes space-time to warp or curve; and gravity is not a force, but rather the product of bodies moving in curved space-time.

Since space and time were separate concepts in Newton's physics, an object's position is simply described by three spatial coordinates. In Einstein's physics, space and time are combined into space-time so that when describing the position of an object one must include all four dimensions—the three spatial dimensions and time. The passage of time is relative to motion, so the time coordinate in the description of position describes time relative to a frame of reference, which is absolutely critical in Einstein's relativity.

CURVATURE OF SPACE-TIME



Show the cadets the WMV video file *Einsteins_Universe_Anima*.
Running time is 1 minute, 9 seconds.

In 1916, Einstein presented the world with this new understanding of the universe—his general theory of relativity. In his theory, space is not an empty void, but an invisible structure called space-time. Nor is space simply a three-dimensional grid through which matter and light and energy move. It is a four-dimensional structure called space-time whose shape is curved and twisted by the presence and motion of matter and energy.

Space-time curves around any mass. The presence of planets, stars and galaxies warps the fabric of space-time in a manner similar to a bowling ball warping a spandex sheet. The mass of the ball stretches the fabric and creates a dip or curve that gradually decreases the further one moves from the mass.

When a mass passes near a larger mass, it accelerates toward the larger mass because space-time itself is curved toward the larger mass. The smaller mass is not “attracted” to the larger mass by any force. The smaller mass simply follows the structure of curved space-time near the larger mass. For example, the massive Sun curves space-time around it, a curvature that reaches out to the edges of the solar system and beyond. The planets orbiting the Sun are following the curvature of space-time by the Sun.



Show the cadets the WMV file *Rel_gyro_expt-anima*.
Running time is 3 minutes, 1 second.

CONFIRMATION OF TEACHING POINT 1

QUESTIONS:

- Q1. What was the speed limit for all matter and energy in the universe under Einstein's 1905 Special Theory of Relativity?
- Q2. How many coordinates describe an object's position in Newton's physics?
- Q3. How many coordinates describe an object's position in Einstein's physics?

ANTICIPATED ANSWERS:

- A1. The speed of light propagating at a finite rate in a vacuum: 299 792 km / sec (185 871 miles / sec).
- A2. In Newton's physics, an object's position is simply described by three spatial coordinates.
- A3. In Einstein's physics, space and time are combined into space-time so that when describing the position of an object one must include all four dimensions—the three spatial dimensions and time.

Teaching Point 2**Describe the Gravity Probe B (GP-B) mission.**

Time: 10 min

Method: Interactive Lecture

GYROSCOPE OPERATION

The gyroscope is a spinning wheel (rotor) in a universal mounting (gimbal) that allows its axle to be pointed in any direction.

Also known as rigidity in space, gyroscopic inertia is the tendency of a rotating object to remain in its plane of rotation. This allows the spin axis of a gyroscope to remain unchanged regardless of how the gimbal is moved around it.



Show the cadets the slide of Figure A-1 located at Attachment A.

Examples of rotating objects that exhibit rigidity in space are tops, gyroscopes, Frisbees, basketballs and any spinning planet. These objects tend to maintain their orientation in space.



Aircraft use gyroscopes for navigation, with the gyroscope maintaining the orientation of the universe so that relative changes in the aircraft's orientation can be measured. In the Gravity Probe B (GP-B) satellite, the gyroscope maintains its orientation relative to a distant guide star so that the changes in the orientation of space-time near Earth can be measured.

To work properly, the rotor must be kept spinning at a constant speed. Gyroscopic instruments may be powered by one or more power sources. In an aircraft, a gyroscope can be powered by moving air systems. In the GP-B satellite, the gyroscopes are powered by helium gas that is stored as liquid in the largest satellite component: the dewar.



Dewar. A double-walled vessel with a vacuum between the walls to reduce the transfer of heat, used for storing hot or cold liquid.



Show the cadets the slide of Figure A-2 located at Attachment A.

THE SPIN AXIS OF A GYROSCOPE

Spin a coin on its edge to show the cadets that it will remain upright while spinning. Demonstrate that the coin will not remain upright on its edge when it is not spinning.

It was predicted that the spin axis of each of GP-B's four gyroscopes move with the curvature and twist of local space-time around Earth. The only way this motion can be detected is by comparing each spin axis to a fixed line of reference. In this mission, the fixed reference line is the line between the telescope and the guide star: IM Pegasi. The telescope has to remain fixed on the exact centre of the guide star (within one milliarcond, or 1 millionth of an inch) throughout the mission or GP-B would lose its single critical reference line.



SQUID (Superconducting QUantum Interference Device). A device that monitors the spin axis orientation of the supercooled, superconducting gyroscope's perfectly unmarked, spherical rotor—without exerting significant torque on the spinning rotor.



Show the cadets the WMV video file *SConSquid*.
Running time is 2 minutes, 12 seconds.

GEODETIC EFFECT

Einstein's theory predicted that the presence of a mass in space, such as the Earth, will warp local space-time, creating a dip or curve in space-time. This is called geodetic effect.

FRAME-DRAGGING EFFECT

One of the predictions of Einstein's general theory of relativity is that local space-time is twisted by the rotation of the Earth—any rotating mass will drag the local space-time frame of reference with it. The predicted drag is very small and fades as one travels further from the rotating mass, but the twist nearby can affect the paths of light, energy, and other masses.

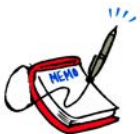

Show the cadets the WMV video file *Simple_expt_anima*.
Running time is 1 minute, 7 seconds.

SPACECRAFT COMPONENTS

The GP-B satellite is composed of thousands of components, but the mission can be understood by considering only a few, to include:

- dewar,
- gyroscopes,
- star tracking telescope, and
- micro thrusters.



Show the cadets the WMV video file *DF-Satellite*.
Running time is 4 minutes 25 seconds.

CANADA'S CONTRIBUTION TO ORIENTATION CONTROL

Astrophysicists at York University measured and tracked the movement of GP-B's guide star, IM Pegasi, against a backdrop of more distant quasars. This allowed minute changes in the position of IM Pegasi to be taken into account when changes in gyroscope orientation was measured—in a system where angles of a millionth of a degree are of critical importance.



Quasar. Any of a class of starlike celestial objects, apparently of great size and remoteness, often associated with a spectrum with a large red shift and intense radio emission.

CONFIRMATION OF TEACHING POINT 2

QUESTIONS:

- Q1. What is meant by rigidity in space?
- Q2. What is geodetic effect?
- Q3. What is frame-dragging effect?

ANTICIPATED ANSWERS:

- A1. Rigidity in space is the tendency of a rotating object to remain in its plane of rotation.
- A2. One of the predictions of Einstein's theory; the presence of a mass in space, such as the Earth, will warp local space-time, creating a dip or curve in space-time.
- A3. One of the predictions of Einstein's general theory of relativity; local space-time is twisted by the rotation of the Earth.

Teaching Point 3

Have the cadets watch *Testing Einstein's Universe*.

Time: 25 min

Method: In-Class Activity

ACTIVITY

OBJECTIVE

The objective of this activity is to have the cadets learn about the GP-B mission by watching *Testing Einstein's Universe* while finding answers to assigned questions.

RESOURCES

- Testing Einstein's Universe DVD,
- Gravity and Space-Time handout located at Attachment B for each cadet,
- Paper, and
- Pens / pencils.

ACTIVITY LAYOUT

Nil.

ACTIVITY INSTRUCTIONS

1. Distribute the Gravity and Space-Time handout located at Attachment B to each cadet.
2. Instruct the cadets to record their answers to the questions in the Gravity and Space-Time handout while watching *Testing Einstein's Universe*.
3. Have the cadets watch *Testing Einstein's Universe*.

SAFETY

Nil.

CONFIRMATION OF TEACHING POINT 3

The cadets' participation in the activity will serve as the confirmation of this TP.

Teaching Point 4

Conduct an activity to correct answers to the assigned questions.

Time: 5 min

Method: In-Class Activity

ACTIVITY

OBJECTIVE

The objective of this activity is to have the cadets check their answers to the questions at Attachment B.

RESOURCES

- Reference C3-310, *Gravity Probe B: An Educator's Guide*,
- Answer Key—Gravity And Space-Time located at Attachment C, and
- Completed Gravity and Space-Time handouts.

ACTIVITY LAYOUT

Nil.

ACTIVITY INSTRUCTIONS

1. Using the answer key located at Attachment C, read the answer to the question.
2. Have the cadets confirm their answer. If required, discuss any discrepancies, referring to Reference C3-310 as necessary.
3. Repeat Steps 1 and 2 for each question.

SAFETY

Nil.

CONFIRMATION OF TEACHING POINT 4

The cadets' participation in the activity will serve as the confirmation of this TP.

END OF LESSON CONFIRMATION

The cadets' participation in watching *Testing Einstein's Universe* will serve as the confirmation of this lesson.

CONCLUSION

HOMEWORK / READING / PRACTICE

Nil.

METHOD OF EVALUATION

Nil.

CLOSING STATEMENT

The relationship between gravity and space-time is still theoretical. However, the relativistic theory of gravity as a manifestation of the curvature of space accounts for more natural phenomena than the classical Newtonian explanation.

INSTRUCTOR NOTES / REMARKS

Nil.

REFERENCES

C3-310 Range, S. K. (2004). *Gravity Probe B: An educator's guide*. Washington, DC: NASA. Retrieved February 6, 2009, from <http://einstein.stanford.edu/RESOURCES/education-index.html#guide>

C3-311 Bartel, N. (Producer & Director). (2003). *Testing Einstein's universe* [Motion picture]. Canada: York University.

C3-312 Range, S. K. (2008). *Gravity Probe B: Testing Einstein's universe*. Retrieved February 6, 2009, from <http://einstein.stanford.edu/index.html>

THIS PAGE INTENTIONALLY LEFT BLANK

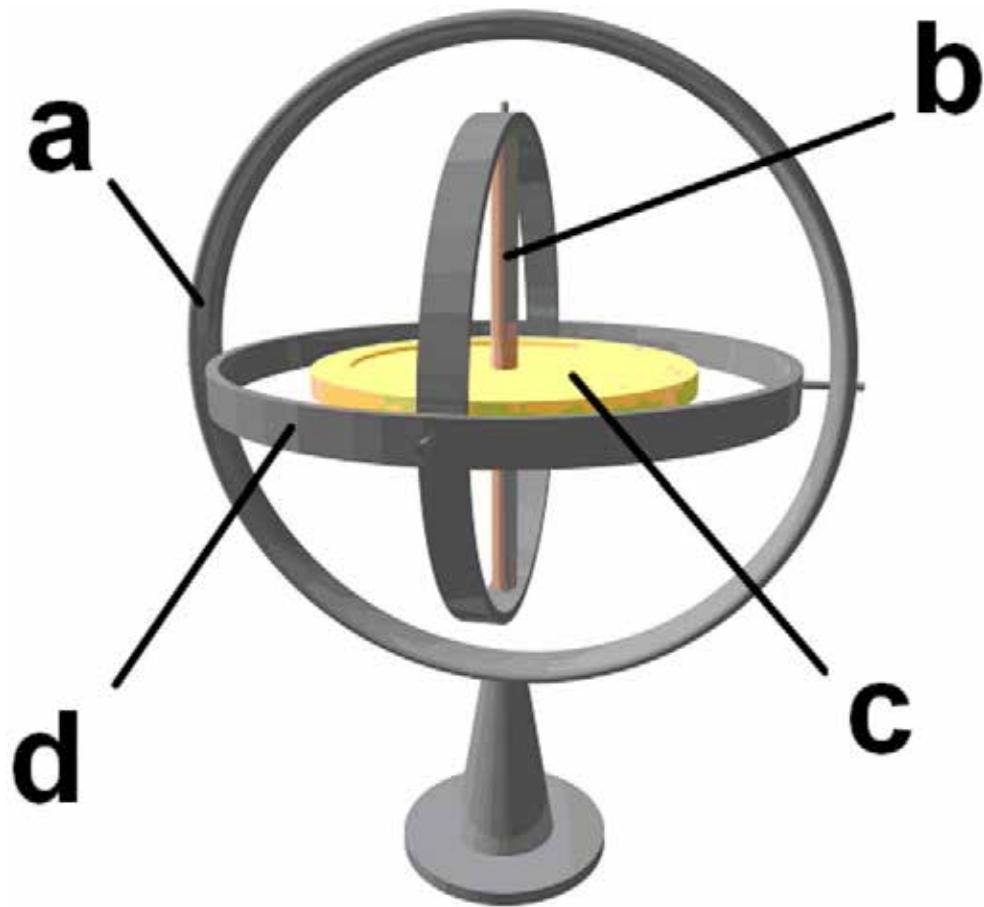

Figure A-1 Gyroscope

Note. From "3D Gyroscope", *Wikimedia*. Retrieved November 18, 2008, from http://upload.wikimedia.org/wikipedia/commons/e/e2/3D_Gyroscope.png

- a. Gyroscope frame
- b. Spin axis
- c. Rotor
- d. Gimbal



Figure A-2 Gravity Probe B Dewar

Note. From *Gravity Probe B: An Educator's Guide*, (p. 30), by S. Shannon, 2004. Washington, DC: NASA.

GRAVITY, SPACE-TIME AND GP-B

Q1. Name two 20th century tests of Einstein's general theory of relativity.

- _____
- _____

Q2. Why was Gravity Probe B placed into a low orbit even though that meant it would be buffeted by the upper atmosphere?

Q3. Why was Gravity Probe B placed into a polar orbit?

Q4. What were three uses of the liquid helium in Gravity Probe B's dewar?

- _____
- _____
- _____

Q5. In Einstein's Equivalence Principle, what is said to be equivalent?

Q6. What is the significance of Gravity Probe B's drag-free status?

THIS PAGE INTENTIONALLY LEFT BLANK

ANSWER KEY—GRAVITY, SPACE-TIME AND GP-B

- Q1. Name two 20th Century tests of Einstein's general theory of relativity.
- A1. Reference C3-310 (pp. 13–14): Any two of:
- precession of Mercury's orbit,
 - starlight deflection during a solar eclipse,
 - gravitational redshift, and
 - shapiro time delay.
- Q2. Why was Gravity Probe B placed into a low orbit even though that meant it would be buffeted by the upper atmosphere?
- A2. Reference C3-310 (p. 32): The effects of local space-time (its curve and twist) weaken dramatically as one moves farther from the Earth. Gravity Probe B was given an orbit that would get it as close to the Earth as possible, to see the space-time effects more clearly.
- Q3. Why was Gravity Probe B placed into a polar orbit?
- A3. WMV file *Rel_gyro_expt-anima*: In a polar orbit the two effects, geodetic and frame-dragging, occur at right angles, providing maximum separation. This makes it possible for a gyroscope to measure both effects simultaneously.
- Q4. What were three uses of the liquid helium in Gravity Probe B's dewar?
- A4. Three uses of the helium in Gravity Probe B's dewar include:
- Reference C3-310 (p. 25): Spinning the gyroscopes,
 - Reference C3-310 (p. 30): Supercooling the instruments, and
 - Reference C3-310 (p. 32): Powering the micro-thrusters.
- Q5. In Einstein's equivalence principle, what is said to be equivalent?
- A5. Reference C3-310 (p. 25): An experience of gravity is equivalent to an experience of acceleration.
- Q6. What is the significance of Gravity Probe B's drag-free status?
- A6. Reference C3-310 (p. 29): The slightest amount of heat or pressure, the influence of a magnetic field, any kind of gravitational acceleration, or the tiniest amount of atmospheric turbulence will destroy the accuracy of the instrument.

THIS PAGE INTENTIONALLY LEFT BLANK



**ROYAL CANADIAN AIR CADETS
PROFICIENCY LEVEL FOUR
INSTRUCTIONAL GUIDE**



SECTION 12

EO C440.10 – DISCUSS KINETIC AND POTENTIAL ENERGY

Total Time:	30 min
-------------	--------

PREPARATION

PRE-LESSON INSTRUCTIONS

Resources needed for the delivery of this lesson are listed in the lesson specification located in A-CR-CCP-804/PG-001, *Proficiency Level Four Qualification Standard and Plan*, Chapter 4. Specific uses for said resources are identified throughout the instructional guide within the TP for which they are required.

Review the lesson content and become familiar with the material prior to delivering the lesson.

Photocopy Attachment A for each group of four cadets for TP 3.

Gather materials needed for the activities in TPs 1–3.

PRE-LESSON ASSIGNMENT

Nil.

APPROACH

An in-class activity was chosen for this lesson as it is an interactive way to provoke thought about energy and stimulate interest in kinetic and potential energy among cadets.

INTRODUCTION

REVIEW

Nil.

OBJECTIVES

By the end of this lesson the cadet shall be expected to discuss kinetic and potential energy.

IMPORTANCE

It is important for cadets to understand the relationship between kinetic and potential energy so that they can recognize the requirements, applications and effects of propulsion systems, especially in a microgravity environment.

Teaching Point 1**Explore the storage and conversion of kinetic and potential energy in a gravitational system.**

Time: 5 min

Method: In-Class Activity

Kinetic energy. Energy of motion. A falling yo-yo has kinetic energy.

Potential energy. Energy that is stored in an object. A yo-yo held above the floor has potential energy because gravity pulls it down.

Kinetic energy can be converted into potential energy and potential energy can be converted back into kinetic energy. This can be seen in the repeated actions of a yo-yo as it goes through its cycles.

Before the yo-yo begins its fall, it has stored energy due to its position above the floor. At the top of its cycle it has its maximum potential energy. As it starts to fall the potential energy begins to be changed into the kinetic energy of falling—but the string, being wound around the yo-yo spindle, converts the kinetic energy of falling into kinetic energy of rotation.

At the bottom, the yo-yo's potential energy has been converted into, first, kinetic energy of falling, which was then converted to rotation. The yo-yo will now have its maximum kinetic energy of rotation. When the string is tightly extended at the bottom of the yo-yo's cycle, its kinetic energy of rotation can be used, by a competent yo-yo operator, to wind the string back around the yo-yo's spindle. It helps to add energy to each cycle of the yo-yo by speeding it on its downward leg. This is necessary due to energy losses from friction.

ACTIVITY**OBJECTIVE**

The objective of this activity is to have the cadets explore the storage and conversion of kinetic and potential energy in a gravitational system by operating a yo-yo.

RESOURCES

Yo-yo (one per cadet).

ACTIVITY LAYOUT

Nil.

ACTIVITY INSTRUCTIONS

1. Distribute a yo-yo to each cadet.
2. Explain the following rules of this competition:
 - a. Cadets shall stand to operate their yo-yos.
 - b. Yo-yos shall be operated vertically only.
 - c. Cadets shall return to their seats when their yo-yo stops.
 - d. The last cadet standing wins the competition.
3. Have the cadets prepare by winding the string around the yo-yo spindle.
4. On command, have the cadets begin cycling their yo-yo.

SAFETY

Cadets shall take care to not hit anyone or anything with their yo-yo.

CONFIRMATION OF TEACHING POINT 1

The cadets' participation in the yo-yo activity will serve as the confirmation of this TP.

Teaching Point 2

Explore the storage and conversion of kinetic and potential energy in an elastic system.

Time: 5 min

Method: In-Class Activity



An elastic band flying through the air has kinetic energy.

When an elastic band is stretched, it gains potential energy. As the elastic band is released, stored potential energy is changed to the kinetic energy of motion.

ACTIVITY**OBJECTIVE**

The objective of this activity is to have the cadets explore the storage and conversion of kinetic and potential energy in an elastic system by using elastic bands in a target competition.

RESOURCES

Elastic bands (two different colours).

ACTIVITY LAYOUT

1. Clear an area at least 3 m on each side of a 2-m line on the floor.
2. Place an empty waste paper basket 3 m from the line.

ACTIVITY INSTRUCTIONS

1. Divide the cadets into two teams.
2. Give each team three elastic bands per cadet, with different colours for each team.
3. Have one member of each team advance to the line and attempt to shoot one elastic band into the waste paper basket by stretching and releasing it.
4. Have each cadet repeat Step 3 three times.
5. Declare the winner based on the team that has the most elastic bands in the waste paper basket.

SAFETY

Cadets shall not aim an elastic band at another person.

CONFIRMATION OF TEACHING POINT 2

The cadets' participation in the elastic band activity will serve as the confirmation of this TP.

Teaching Point 3**Explore the effects of velocity and mass in the expenditure of energy.**

Time: 15 min

Method: In-Class Activity



This TP consists of making a series of craters of various sizes. Point out to the cadets the features of the craters they create as shown in Figure 1 (Lunar crater Aristarchus, 42 km in diameter, located west of Mare Imbrium).

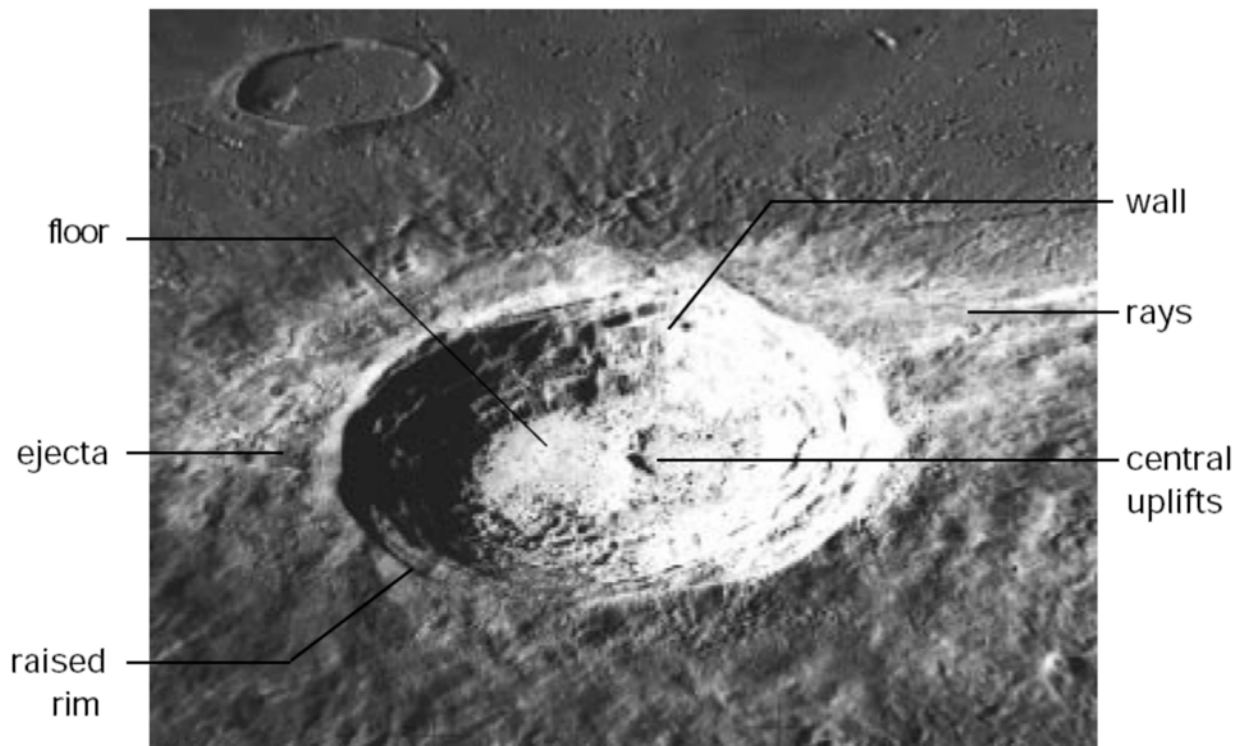

Figure 1 Parts of a Crater

Note: From NASA, 1997, Exploring the Moon: A Teacher's Guide With Activities.
Retrieved September 30, 2008, from <http://lunar.arc.nasa.gov/education/pdf/expmoon.pdf>



The energy of a moving object is equal to its mass (weight) multiplied by the square of its velocity, or $E = mv^2$. An object travelling twice as fast will therefore deliver four times the energy at impact, and an object travelling three times as fast results in nine times the energy at impact.

ACTIVITY**OBJECTIVE**

The objective of this activity is to have the cadets explore the effects of velocity and mass in the expenditure of energy through the creation of a series of craters.

RESOURCES

- Impact Crater Data Chart located at Attachment A,
- Plastic tubs approximately 10 cm deep, 20 cm wide and 30 cm long,
- Ruler marked in millimetres,
- Sand (half tub),
- Cornstarch (half tub), and
- Impactors, to include:
 - marbles of various sizes,
 - ball bearings of various sizes,
 - wooden balls of various sizes, and
 - golf balls.

ACTIVITY LAYOUT

1. Place a tub of mixed dry sand and cornstarch in the centre of an area that is clear at least 3 m on each side.
2. During this activity, the sand mixture may fall onto the floor and the cornstarch may even be dispersed into the air. Spread newspaper under the pan(s) to catch spills or conduct the activity outside.

ACTIVITY INSTRUCTIONS

1. Divide the cadets into groups of no more than four.
2. Distribute one Impact Crater Data Chart located at Attachment A to each group.
3. Have the cadets drop impactors of various sizes into the tub of mixed sand and cornstarch from a height of 30 cm as per Attachment A.
4. Have the cadets measure the resulting craters and then select an effective impactor for the following exercise (an effective impactor will produce maximum rays, crater walls, a raised rim, and ejecta as shown in Figure 1, but it may not be possible to create a central uplift).
5. Have the cadets smooth and resurface the material in the pan before each impact. The material does not need to be packed down.



Shaking or tilting the pan back and forth produces a smooth surface. Better experimental control is achieved with consistent handling of the materials. For instance, cratering results may vary if the material is packed down for some trials and not for others.

6. Explain to the cadets that because of the low velocity of the experimental impactors compared with the velocity of real impactors, the experimental impact craters may not have significantly raised rims or central uplifts.
7. Have the cadets drop the impactor from increasing heights and record their data as per Attachment A.
8. Have the cadets analyze their results. They should observe that the higher drop height and resulting increase in velocity of the impactor creates a larger crater and spreads the ejecta out further.

SAFETY

Nil.

CONFIRMATION OF TEACHING POINT 3

The cadets' participation in the crater activity will serve as the confirmation of this TP.

END OF LESSON CONFIRMATION

The cadets' participation in exploring the storage and conversion of kinetic and potential energy in a gravitational system, the conversion of kinetic and potential energy in an elastic system, and the effects of velocity and mass in the expenditure of energy will serve as the confirmation of this lesson.

CONCLUSION

HOMEWORK / READING / PRACTICE

Nil.

METHOD OF EVALUATION

Nil.

CLOSING STATEMENT

A coasting spaceship has kinetic energy that was gained from the potential energy stored in its fuel. A good understanding of the relationship between kinetic and potential energy helps to recognize the requirements, applications and effects of propulsion systems.

INSTRUCTOR NOTES / REMARKS

Cadets who are qualified Advanced Aerospace may assist with this instruction.

REFERENCES

C3-262 Canadian Space Agency. (2003). *Orbital mechanics: Energy*. Retrieved September 30, 2008, from <http://www.space.gc.ca/eng/educators/resources/orbital/energy.asp>

C3-263 EG-1997-10-116-HQ NASA. (1997). *Exploring the moon: A teacher's guide with activities*. Retrieved September 30, 2008, from <http://lunar.arc.nasa.gov/education/pdf/expmoon.pdf>

Name: _____

Date: _____

impactor #
 gm

Impact Craters - Data Chart

		trial 1	trial 2	trial 3	total	average
drop height = 30 cm velocity = 242 cm/s	crater diameter					
	crater depth					
	average length of all rays					
drop height = 60 cm velocity = 343 cm/s	crater diameter					
	crater depth					
	average length of all rays					
drop height = 90 cm velocity = 420 cm/s	crater diameter					
	crater depth					
	average length of all rays					
drop height = 2 m velocity = 626 cm/s	crater diameter					
	crater depth					
	average length of all rays					

Figure A-1 Impact Crater Data Chart

Note: From NASA, 1997, *Exploring the Moon: A Teacher's Guide With Activities*.
 Retrieved September 30, 2008, from <http://lunar.arc.nasa.gov/education/pdf/expmoon.pdf>

THIS PAGE INTENTIONALLY LEFT BLANK



**ROYAL CANADIAN AIR CADETS
PROFICIENCY LEVEL FOUR
INSTRUCTIONAL GUIDE**



SECTION 13

EO C440.11 – WATCH EINSTEIN'S BIG IDEA

Total Time:	150 min
-------------	---------

PREPARATION

PRE-LESSON INSTRUCTIONS

Resources needed for the delivery of this lesson are listed in the lesson specification located in A-CR-CCP-804/PG-001, *Proficiency Level Four Qualification Standard and Plan*, Chapter 4. Specific uses for said resources are identified throughout the instructional guide within the TP for which they are required.

Review the lesson content and become familiar with the material prior to delivering the lesson.

Photocopy Attachment A for each cadet.

Photocopy the note template handout located at Attachment B.

Cue the DVD *Einstein's Big Idea*.

PRE-LESSON ASSIGNMENT

Nil.

APPROACH

An in-class activity was chosen for this lesson as it is an interactive way to provoke thought and stimulate interest among cadets about the development of the formula $E=mc^2$.

INTRODUCTION

REVIEW

Nil.

OBJECTIVES

By the end of this lesson the cadet shall be expected to discuss the history of the formula $E=mc^2$.

IMPORTANCE

It is important for cadets to be able to discuss the history of the formula $E=mc^2$ so that they recognize that science is a team effort, which transcends both national boundaries and the centuries.

Teaching Point 1

Conduct an activity where the cadets to define energy and describe kinds of energy and differences between sources of energy.

Time: 5 min

Method: In-Class Activity



The term energy refers to the amount of work that can be performed by a system:

Potential energy. The energy an object has due to its position or condition.

Kinetic energy. The energy due to the motion of an object.

ACTIVITY

OBJECTIVE

The objective of this activity is to have the cadets brainstorm definitions of energy and to describe kinds of energy and differences between sources of energy.

RESOURCES

Nil.

ACTIVITY LAYOUT

Nil.

ACTIVITY INSTRUCTIONS

1. Have the cadets brainstorm definitions of energy.
2. Have the cadets list what kinds of energy they have used today.
3. Have the cadets list sources of energy (eg, sun, oil, natural gas, gasoline, wind, hydroelectric, nuclear, coal, wood, and food).
4. Point out that many of these are means of storing energy (eg, chemical storage such as natural gas) or forms of energy that are converted before becoming useful (eg, electrical energy converted to heat or mechanical energy).

SAFETY

Nil.

CONFIRMATION OF TEACHING POINT 1

The cadets' participation in the activity will serve as the confirmation of this TP.

Teaching Point 2**Have the cadets determine that atoms of matter have mass.**

Time: 10 min

Method: In-Class Activity



The nucleus of an atom is made up of protons and neutrons in a cluster. Virtually all the mass of the atom resides in the nucleus. The nucleus is held together by the tight pull of what is known to chemists and physicists as the "strong force". This force between the protons and neutrons overcomes the repulsive electrical force that would, according to the rules of electricity, otherwise push the positively-charged protons apart.

ACTIVITY**OBJECTIVE**

The objective of this activity is to have the cadets determine that the atoms that constitute matter have mass.

RESOURCES

Handout located at Attachment A.

ACTIVITY LAYOUT

Nil.

ACTIVITY INSTRUCTIONS

1. Make a list of common materials on a flip chart or whiteboard, to include:
 - a. air,
 - b. water,
 - c. living organisms,
 - d. the sun, and
 - e. jewellery
2. Have the cadets identify the primary elements in air (nitrogen, oxygen), water (hydrogen, oxygen), living organisms (carbon, nitrogen, oxygen, hydrogen), the sun (hydrogen, helium), and jewellery (nickel, silver, gold).
3. Have the cadets locate those elements in a periodic table and determine their atomic mass.

SAFETY

Nil.

CONFIRMATION OF TEACHING POINT 2

The cadets' participation in the activity will serve as the confirmation of this TP.

Teaching Point 3

Have the cadets watch *Einstein's Big Idea* and make notes on topics assigned.

Time: 110 min

Method: In-Class Activity



Before watching *Einstein's Big Idea*, arrange for the cadets, singly or in groups, to make notes using the six handouts located at Attachment B.

The six note templates do not correspond to chapters in the motion picture. Information for the note templates will be found throughout the motion picture.

ACTIVITY

OBJECTIVE

The objective of this activity is to have the cadets take notes on their assigned topics while watching *Einstein's Big Idea*.

RESOURCES

- *Einstein's Big Idea* DVD,
- Note template handouts located at Attachment B, and
- Pens / pencils.

ACTIVITY LAYOUT

Nil.

ACTIVITY INSTRUCTIONS

1. Distribute the six note template handouts located at Attachment B. Each cadet should have one of the six note templates. If there are more than six cadets, they may form teams.
2. Ensure each template located at Attachment B has at least one cadet assigned to it.
3. Play *Einstein's Big Idea*.
4. Have the cadets, while watching *Einstein's Big Idea*, take notes on their assigned topics.

SAFETY

Nil.

CONFIRMATION OF TEACHING POINT 3

The cadets' participation in the activity will serve as the confirmation of this TP.

Teaching Point 4**Conduct an activity to create a timeline of the development of the formula $E=mc^2$.**

Time: 15 min

Method: In-Class Activity

ACTIVITY**OBJECTIVE**

The objective of this activity is to have the cadets construct a timeline showing the development of the formula $E=mc^2$.

RESOURCES

- String,
- Paper clips,
- Pens / pencils, and
- Completed note templates from TP 3.

ACTIVITY LAYOUT

Place a 3-m string across a classroom wall. Create a timeline ranging from 1700 to 1950 from the string by hanging paper century markers on the string with paper clips.

ACTIVITY INSTRUCTIONS

1. Have a cadet describe an assigned topic and the scientist's challenges and accomplishments.
2. Have the cadet clip the notes about that scientist to the appropriate place on the string.
3. Repeat for each scientist or team of scientists.
4. Draw the cadets' attention to the way that scientific research crossed national frontiers over very long periods of time. Point out that although historic contributors such as Socrates, Aristotle, Leonardo da Vinci and Sir Isaac Newton are not shown on this short timeline, their ideas were essential to the discoveries in *Einstein's Big Idea*.

SAFETYNil.

CONFIRMATION OF TEACHING POINT 4

The cadets' participation in the activity will serve as the confirmation of this TP.

END OF LESSON CONFIRMATION

The cadets' participation in the timeline construction activity will serve as the confirmation of this lesson.

CONCLUSION

HOMEWORK / READING / PRACTICE

Nil.

METHOD OF EVALUATION

Nil.

CLOSING STATEMENT

Science is a team effort that transcends national boundaries and time. Our understanding of matter and energy are still very incomplete; while today we know more about light than Faraday and Maxwell, more about mass than the Lavoisiers and more about energy than du Châtelet, we have nevertheless scarcely begun. Science is teamwork in progress and it is not too late to join the team.

INSTRUCTOR NOTES / REMARKS

If EO C440.09 (Describe the Relationship Between Gravity and Space-Time) or EO C440.10 (Discuss Kinetic and Potential Energy) are also selected, they should be presented prior to this lesson to introduce concepts of energy.

It is recommended that Chapters 1–6 of Einstein's Big Idea be presented in three consecutive periods and Chapters 7–9 be presented in two consecutive periods, all on two consecutive training days.

REFERENCES

C3-319 NOVA. (2005). *Teacher's guide: Einstein's big idea*. Retrieved January 30, 2009 from <http://www.pbs.org/wgbh/nova/einstein/>

C3-320 Johnstone, G. (Producer & Director). (2005). *Einstein's big idea* [Motion picture]. United States: WBGH Educational Foundation.

Table of Element Abbreviations and Names

Ac	Actinium	Ha	Hahnium	P	Phosphorus
Ag	Silver	He	Helium	Pr	Praseodymium
Al	Aluminum	Hf	Hafnium	Pt	Platinum
Am	Americium	Hg	Mercury	Pu	Plutonium
Ar	Argon	H	Hydrogen	Ra	Radium
As	Arsenic	Ho	Holmium	Rb	Rubidium
At	Astatine	Hs	Hassium	Re	Rhenium
Au	Gold	I	Iodine	Rf	Rutherfordium
Ba	Barium	In	Indium	Rh	Rhodium
B	Boron	Ir	Iridium	Rn	Radon
Be	Beryllium	Kr	Krypton	Ru	Ruthenium
Bi	Bismuth	La	Lanthanum	Sb	Antimony
Bk	Berkelium	Li	Lithium	Sc	Scandium
Br	Bromine	Lr	Lawrencium	Se	Selenium
Ca	Calcium	Lu	Lutetium	Sg	Seaborgium
C	Carbon	Md	Mendelevium	Si	Silicon
Cd	Cadmium	Mg	Magnesium	Sm	Samarium
Ce	Cerium	Mn	Manganese	Sn	Tin
Cf	Californium	Mo	Molybdenum	Sr	Strontium
Cl	Chlorine	Mt	Meitnerium	S	Sulfur
Cm	Curium	Na	Sodium	Ta	Tantalum
Co	Cobalt	Nb	Niobium	Tb	Terbium
Cr	Chromium	Nd	Neodymium	Tc	Technetium
Cs	Cesium	Ne	Neon	Te	Tellurium
Cu	Copper	Ni	Nickel	Th	Thorium
Dy	Dysprosium	N	Nitrogen	Ti	Titanium
Er	Erbium	No	Nobelium	Tl	Thallium
Es	Einsteinium	Np	Neptunium	Tm	Thulium
Eu	Europium	Ns	Neilsborium	U	Uranium
Fe	Iron	O	Oxygen	V	Vanadium
F	Fluorine	Os	Osmium	W	Tungsten
Fm	Fermium	Pa	Protactinium	Xe	Xenon
Fr	Francium	Pb	Lead	Yb	Ytterbium
Ga	Gallium	Pd	Palladium	Y	Yttrium
Gd	Gadolinium	Pm	Promethium	Zn	Zinc
Ge	Germanium	Po	Polonium	Zr	Zirconium

Figure A-1 Element Abbreviations and Names

Note: From "Los Alamos National Laboratory's Chemistry Division Presents", 2004, *Periodic Table of the Elements: A Resource for Elementary, Middle School, and High School Students*. Retrieved February 11, 2009, from <http://periodic.lanl.gov/default.htm>

Simplified Periodic Table of the Elements

1 H 1.008																	2 He 4.003																												
3 Li 6.941	4 Be 9.012																	5 B 10.81	6 C 12.01	7 N 14.01	8 O 16.00	9 F 19.00	10 Ne 20.18																						
11 Na 22.99	12 Mg 24.31																	13 Al 26.98	14 Si 28.09	15 P 30.97	16 S 32.07	17 Cl 35.45	18 Ar 39.95																						
19 K 39.10	20 Ca 40.08	21 Sc 44.96	22 Ti 47.88	23 V 50.94	24 Cr 52.00	25 Mn 54.94	26 Fe 55.85	27 Co 58.47	28 Ni 58.69	29 Cu 63.55	30 Zn 65.39	31 Ga 69.72	32 Ge 72.59	33 As 74.92	34 Se 78.96	35 Br 79.90	36 Kr 83.80																												
37 Rb 85.47	38 Sr 87.62	39 Y 88.91	40 Zr 91.22	41 Nb 92.91	42 Mo 95.94	43 Tc (98)	44 Ru 101.1	45 Rh 102.9	46 Pd 106.4	47 Ag 107.9	48 Cd 112.4	49 In 114.8	50 Sn 118.7	51 Sb 121.8	52 Te 127.6	53 I 126.9	54 Xe 131.3																												
55 Cs 132.9	56 Ba 137.3	57 La* 138.9	72 Hf 178.5	73 Ta 180.9	74 W 183.9	75 Re 186.2	76 Os 190.2	77 Ir 190.2	78 Pt 195.1	79 Au 197.0	80 Hg 200.5	81 Tl 204.4	82 Pb 207.2	83 Bi 209.0	84 Po (210)	85 At (210)	86 Rn (222)																												
87 Fr (223)	88 Ra (226)	89 Ac~ (227)	104 Rf (257)	105 Db (260)	106 Sg (263)	107 Bh (262)	108 Hs (265)	109 Mt (266)	110 --- ()	111 --- ()	112 --- ()	114 --- ()	116 --- ()	118 --- ()			118 --- ()																												
<table border="1"> <tbody> <tr> <td>58 Ce 140.1</td> <td>59 Pr 140.9</td> <td>60 Nd 144.2</td> <td>61 Pm (147)</td> <td>62 Sm 150.4</td> <td>63 Eu 152.0</td> <td>64 Gd 157.3</td> <td>65 Tb 158.9</td> <td>66 Dy 162.5</td> <td>67 Ho 164.9</td> <td>68 Er 167.3</td> <td>69 Tm 168.9</td> <td>70 Yb 173.0</td> <td>71 Lu 175.0</td> </tr> <tr> <td>90 Th 232.0</td> <td>91 Pa (231)</td> <td>92 U (238)</td> <td>93 Np (237)</td> <td>94 Pu (242)</td> <td>95 Am (243)</td> <td>96 Cm (247)</td> <td>97 Bk (247)</td> <td>98 Cf (249)</td> <td>99 Es (254)</td> <td>100 Fm (253)</td> <td>101 Md (256)</td> <td>102 No (254)</td> <td>103 Lr (257)</td> </tr> </tbody> </table>																		58 Ce 140.1	59 Pr 140.9	60 Nd 144.2	61 Pm (147)	62 Sm 150.4	63 Eu 152.0	64 Gd 157.3	65 Tb 158.9	66 Dy 162.5	67 Ho 164.9	68 Er 167.3	69 Tm 168.9	70 Yb 173.0	71 Lu 175.0	90 Th 232.0	91 Pa (231)	92 U (238)	93 Np (237)	94 Pu (242)	95 Am (243)	96 Cm (247)	97 Bk (247)	98 Cf (249)	99 Es (254)	100 Fm (253)	101 Md (256)	102 No (254)	103 Lr (257)
58 Ce 140.1	59 Pr 140.9	60 Nd 144.2	61 Pm (147)	62 Sm 150.4	63 Eu 152.0	64 Gd 157.3	65 Tb 158.9	66 Dy 162.5	67 Ho 164.9	68 Er 167.3	69 Tm 168.9	70 Yb 173.0	71 Lu 175.0																																
90 Th 232.0	91 Pa (231)	92 U (238)	93 Np (237)	94 Pu (242)	95 Am (243)	96 Cm (247)	97 Bk (247)	98 Cf (249)	99 Es (254)	100 Fm (253)	101 Md (256)	102 No (254)	103 Lr (257)																																

Template

Atomic Number
Atomic Symbol
Atomic Mass

Figure A-2 Simplified Periodic Table

Note: From "Los Alamos National Laboratory's Chemistry Division Presents", 2004, *Periodic Table of the Elements: A Resource for Elementary, Middle School, and High School Students*. Retrieved February 11, 2009, from <http://periodic.lanl.gov/default.htm>

Energy

Scientists

Nationality

Concept

Experiment

Time Period

Challenges Faced

Mass

Scientists

Nationality

Concept

Experiment

Time Period

Challenges Faced

Light

Scientists

Nationality

Concept

Experiment

Time Period

Challenges Faced

Velocity (Speed of Light Squared)

Scientists

Nationality

Concept

Experiment

Time Period

Challenges Faced

Development of the Equation $E=mc^2$

Scientists

Nationality

Concept

Experiment

Time Period

Challenges Faced

Confirmation of the Equation $E=mc^2$

Scientists

Nationality

Concept

Experiment

Time Period

Challenges Faced

Energy

Scientist

Michael Faraday.

Nationality

English.

Concept

Invisible lines of force flow around electricity and magnets; electricity and magnetism are linked.

Experiment

Faraday placed a magnet beside a copper wire suspended in mercury and passed an electric current through the wire. The wire spun in a circle around the magnet, thus demonstrating the interaction of lines of electric and magnetic force.

Time Period

Early 1800s.

Challenges Faced

Accused of plagiarism by Sir Humphry Davy; refuted claim and was later elected to the Royal Society.

Mass

Scientists

Antoine-Laurent and Marie Anne Lavoisier.

Nationality

French.

Concept

Matter is always conserved in a chemical reaction regardless of how it is transformed.

Experiment

Lavoisier transformed a number of different substances. He carefully measured all the products of the reactions to show that matter is conserved.

Time Period

Late 1700s.

Challenges Faced

The French Revolution; Antoine-Laurent Lavoisier was captured and executed by guillotine.

Light

Scientists

Michael Faraday and James Clerk Maxwell.

Nationality

English (Faraday) and Scottish (Maxwell).

Concept

Electromagnetism can be described mathematically; Maxwell's equations supported Faraday's long-held claims that light was just one form of electromagnetism.

Experiment

Maxwell's ideas were theoretical.

Time Period

Mid-1800s.

Challenges Faced

Scientists did not agree with Faraday's belief that light was an electromagnetic wave.

Velocity (Speed of Light Squared)

Scientists

Emilie du Châtelet and Gottfried von Leibniz.

Nationality

French (du Châtelet) and German (Leibniz).

Concept

The energy of an object is a function of the square of its speed, rather than its speed.

Experiment

Du Châtelet analyzed experiments in which brass balls were dropped into clay; measuring their impacts demonstrated that an object's energy is a function of its velocity squared. She corrected Newton and clarified Leibniz's original ideas about velocity.

Time Period

Early to mid-1700s.

Challenges Faced

Scientists discounted Leibniz' ideas; du Châtelet died during childbirth when she was 43.

Development of the Equation $E=mc^2$

Scientist

Albert Einstein.

Nationality

German, Swiss, and American.

Concept

Mass and energy are the same and can be converted from one to the other using the speed of light squared.

Experiment

Einstein's ideas were theoretical.

Time Period

Early 1900s.

Challenges Faced

At first no one responded to Einstein's ideas; he patiently answered letters for four years. His genius began to be recognized when his work gained the endorsement of German physicist Max Planck.

Confirmation of the Equation $E=mc^2$

Scientists

Otto Hahn, Fritz Strassmann, Lise Meitner, and Otto Robert Frisch.

Nationality

German (Hahn, Strassmann) and Austrian (Meitner, Frisch).

Concept

The confirmation of $E=mc^2$.

Experiment

Hahn and Strassmann bombarded uranium with neutrons and discovered barium in the resulting products; Meitner and Frisch realized the results indicated that Hahn and Strassmann had split the uranium nucleus.

Time Period

Mid-1900s.

Challenges Faced

Since she was Jewish, Meitner was forced to flee Germany and compelled to collaborate by mail with Hahn and Strassmann, but Hahn never acknowledged Meitner's work.



ROYAL CANADIAN AIR CADETS
PROFICIENCY LEVEL FOUR
INSTRUCTIONAL GUIDE



SECTION 1

EO C460.01 – DESCRIBE AERODROME OPERATIONS CAREER OPPORTUNITIES

Total Time:	30 min
-------------	--------

PREPARATION

PRE-LESSON INSTRUCTIONS

Resources needed for the delivery of this lesson are listed in the lesson specification located in A-CR-CCP-804/PG-001, *Proficiency Level Four Qualification Standard and Plan*, Chapter 4. Specific uses for said resources are identified throughout the instructional guide within the TP for which they are required.

Review the lesson content and become familiar with the material prior to delivering the lesson.

PRE-LESSON ASSIGNMENT

Nil.

APPROACH

An in-class activity was chosen for TP 1 as it is an interactive way to provoke thought and stimulate interest among cadets.

A group discussion was chosen for TP 2 as it allows the cadets to interact with their peers and share their knowledge, experiences, opinions, and feelings on aerodrome operations career opportunities.

INTRODUCTION

REVIEW

Nil.

OBJECTIVES

By the end of this lesson the cadet shall be expected to describe aerodrome operations career opportunities.

IMPORTANCE

It is important for cadets to describe aerodrome operations career opportunities as there are a wide variety of careers available in this field. An ability to describe these career opportunities is an important step in the process of preparing cadets for aviation-related careers.

Teaching Point 1

Have the cadets brainstorm aerodrome operations career opportunities.

Time: 10 min

Method: In-Class Activity

ACTIVITY

OBJECTIVE

The objective of this activity is to have the cadets brainstorm a list of aerodrome operations career opportunities.

RESOURCES

- Flip chart paper, and
- Markers.

ACTIVITY LAYOUT

Nil.

ACTIVITY INSTRUCTIONS

1. Divide the cadets into groups of no more than three.
2. Distribute a piece of flip chart paper and a marker to each group.
3. Have each group brainstorm a list of aerodrome operations career opportunities.
4. Have each group present their list to the class.



Encourage the cadets to consider career opportunities at various types of airports (eg, private, municipal, regional, national, international).

SAFETY

Nil.

CONFIRMATION OF TEACHING POINT 1

The cadets' participation in the activity will serve as the confirmation of this TP.

Teaching Point 2**Conduct a group discussion on aerodrome operations career opportunities.**

Time: 15 min

Method: Group Discussion

BACKGROUND KNOWLEDGE



The purpose of the group discussion is to draw the following information from the group using the tips for answering / facilitating discussion and the suggested questions provided.

AERODROME OPERATIONS CAREER OPPORTUNITIES**Aerodrome Operations Careers**

The career opportunities at aerodromes vary widely, depending on the type of aerodrome. At a small aerodrome, there are fewer positions available, but these positions require an extensive set of skills. Typical positions at a small aerodrome might include:

- aerodrome manager,
- equipment operator, and
- ramp attendant.

It is not uncommon at a small aerodrome for one person to be required to fulfill multiple roles (eg, the manager may also have to operate the equipment and refuel aircraft).

At a large aerodrome, there are more positions available and these positions are more specialized. Additionally, very large aerodromes can be compared to a small city. Typical positions at a large aerodrome might include:

- manager of airside operations,
- manager of groundside operations,
- personnel manager,
- cargo handler,
- refuelling specialist,
- various accounting and administrative positions,
- safety inspectors,
- terminal concession operators,
- building maintenance personnel,
- vehicle maintenance personnel, and
- electrical / mechanical maintenance personnel.

Skills and Training Required

The skills and training required for a career in aerodrome operations will vary depending on the specific career desired and the type of aerodrome. Some of the skills and training that might be required include:

- aviation knowledge, such as:
 - principles of flight,
 - meteorology,
 - air law,
 - navigation, and
 - airmanship;
- radio communications procedures,
- equipment operation (eg, tractors, mowers, trucks, specialty vehicles),
- safety training, such as:
 - first aid,
 - hazardous material handling, and
 - safety reporting and auditing;
- knowledge of management / leadership principles,
- knowledge of marketing concepts,
- knowledge of accounting principles,
- mechanical / technical skills,
- customer service skills,
- aircraft recognition skills, and
- communication (written and verbal) skills.

Training Institutions

There are several well-known post-secondary programs in Canada that specialize in aerodrome operations.

The British Columbia Institute of Technology (BCIT) School of Transportation offers a diploma of Technical Studies in Airport Operations at its Aerospace Technology Campus in Kelowna, B.C.

Georgian College in Barrie, Ont., offers a three-year diploma in Aviation Management that includes co-operative work experience.

The University of Western Ontario, in London, Ont., offers a Bachelor of Administrative and Commercial Studies, Commercial Aviation Management Degree that combines a Commercial Pilot Licence with extensive study in business administration and aviation subjects.

GROUP DISCUSSION



TIPS FOR ANSWERING / FACILITATING DISCUSSION:

- Establish ground rules for discussion, eg, everyone should listen respectfully; don't interrupt; only one person speaks at a time; no one's ideas should be made fun of; you can disagree with ideas but not with the person; try to understand others as much as you hope they understand you; etc.
- Sit the group in a circle, making sure all cadets can be seen by everyone else.
- Ask questions that will provoke thought; in other words avoid questions with yes or no answers.
- Manage time by ensuring the cadets stay on topic.
- Listen and respond in a way that indicates you have heard and understood the cadet. This can be done by paraphrasing their ideas.
- Give the cadets time to respond to your questions.
- Ensure every cadet has an opportunity to participate. One option is to go around the group and have each cadet answer the question with a short answer. Cadets must also have the option to pass if they wish.
- Additional questions should be prepared ahead of time.

SUGGESTED QUESTIONS:

- Q1. What type of skills would the manager of a small aerodrome need?
- Q2. What type of skills would the manager of a large aerodrome need?
- Q3. What type of skills and training would be common to any career at any size aerodrome?
- Q4. What aviation-specific knowledge would be needed to work at an aerodrome?
- Q5. Why would knowledge of meteorology be important for someone working at an aerodrome?
- Q6. Why would knowledge of radio communication procedures be important for someone working at an aerodrome?
- Q7. Which employees at an aerodrome would need to understand accounting? Why?
- Q8. Why would an airport manager need to be able to communicate using written methods of communication?
- Q9. Which post-secondary training institutions offer specialized aerodrome operations programs?
- Q10. Which type of university degrees would be helpful to someone looking for a career in aerodrome operations?



Other questions and answers will develop throughout the group discussion. The group discussion should not be limited to only those suggested.



Reinforce those answers given and comments made during the group discussion, ensuring the teaching points have been covered.

CONFIRMATION OF TEACHING POINT 2

The cadets' participation in the group discussion will serve as the confirmation of this TP.

END OF LESSON CONFIRMATION

The cadets' participation in the group discussion on aerodrome operations career opportunities will serve as the confirmation of this lesson.

CONCLUSION

HOMEWORK / READING / PRACTICE

Nil.

METHOD OF EVALUATION

Nil.

CLOSING STATEMENT

A wide variety of career opportunities exist in the aerodrome operations field. Part of the process of preparing for a career in this field is to describe the career opportunities. By describing the opportunities and discussing the skills, required training, and training institutes you may be able to decide if one of these careers is the one for you.

INSTRUCTOR NOTES / REMARKS

If available, a guest speaker from the field of aerodrome operations may be used for this lesson.

REFERENCES

C3-309 Avjobs.com. (2009). *Aviation career overviews*. Retrieved February 9, 2009, from <http://www.avjobs.com/careers/index.asp>

C3-313 Canadian Airports Council. (2009). *Post secondary programs*. Retrieved February 9, 2009, from http://www.cacairports.ca/english/careers/post_secondary_programs.php



ROYAL CANADIAN AIR CADETS
PROFICIENCY LEVEL FOUR
INSTRUCTIONAL GUIDE



SECTION 2

EO C460.02 – DESCRIBE AIR TRAFFIC CONTROL (ATC) CAREER OPPORTUNITIES

Total Time:

30 min

PREPARATION

PRE-LESSON INSTRUCTIONS

Resources needed for the delivery of this lesson are listed in the lesson specification located in A-CR-CCP-804/PG-001, *Proficiency Level Four Qualification Standard and Plan*, Chapter 4. Specific uses for said resources are identified throughout the instructional guide within the TP for which they are required.

Review the lesson content and become familiar with the material prior to delivering the lesson.

PRE-LESSON ASSIGNMENT

Have the cadets visit the NAV CANADA ATC careers web site (<http://takecharge.navcanada.ca>) or provide handouts of the content on the web site at least one week prior to the lesson.

APPROACH

An in-class activity was chosen for TP 1 as it is an interactive way to provoke thought and stimulate interest in ATC career opportunities among cadets.

A group discussion was chosen for TP 2 as it allows the cadets to interact with their peers and share their knowledge, opinions and feelings about ATC career opportunities.

INTRODUCTION

REVIEW

Nil.

OBJECTIVES

By the end of this lesson the cadet shall be expected to describe ATC career opportunities.

IMPORTANCE

It is important for cadets to describe ATC career opportunities as ATC is responsible for the safe and efficient flow of air traffic. An ability to describe these career opportunities is an important step in the process of preparing cadets for aviation-related careers.

Teaching Point 1

Have the cadets brainstorm ATC career opportunities.

Time: 10 min

Method: In-Class Activity

ACTIVITY

OBJECTIVE

The objective of this activity is to have the cadets brainstorm a list of ATC career opportunities.

RESOURCES

- Flip chart paper, and
- Markers.

ACTIVITY LAYOUT

Nil.

ACTIVITY INSTRUCTIONS

1. Divide the cadets into groups of no more than three.
2. Distribute a piece of flip chart paper and a marker to each group.
3. Have each group brainstorm a list of ATC career opportunities.
4. Have each group present their list to the class.



Encourage the cadets to consider ATC career opportunities at various types of airports (eg, private, municipal, regional, national, international).

SAFETY

Nil.

CONFIRMATION OF TEACHING POINT 1

The cadets' participation in the activity will serve as the confirmation of this TP.

Teaching Point 2**Conduct a group discussion on ATC career opportunities.**

Time: 15 min

Method: Group Discussion

BACKGROUND KNOWLEDGE



The purpose of the group discussion is to draw the following information from the group using the tips for answering / facilitating discussion and the suggested questions provided.

ATC CAREER OPPORTUNITIES

ATC in Canada is provided by a private, not for profit company called NAV CANADA. NAV CANADA is responsible for the selection and training processes. Transport Canada is responsible for setting the prerequisites for candidates and the ensuring that the candidates meet the required standards prior to issuing an ATC license.

ATC Careers

There are three main career opportunities in the ATC field:

- flight service specialist,
- instrument flight rules (IFR) air traffic controller, and
- visual flight rules (VFR) air traffic controller.

As a person gains experience in their chosen option, additional opportunities become available (eg, supervisory and management opportunities).



Additional career opportunities exist outside of ATC within NAV CANADA. A list of current opportunities can be view at the NAV CANADA web site (<http://www.navcanada.ca>) in the Careers section.

Selection Requirements

Previous aviation-related experience and knowledge is not required to be selected for ATC training. The aviation knowledge required is part of the training. In order to be selected for ATC training, all candidates must be:

- at least 18 years old,
- a Canadian citizen (or permanent resident),
- a high school graduate,
- available for training within the next 18 months,
- willing to relocate,
- willing to undergo a medical exam,
- prepared to undergo a security check (secret level),

- willing to train intensively, and
- English-speaking or fluently bilingual (English and French).

Selection Process

The selection process is designed to select the best applicants who have:

- sharp judgment,
- strong motivation,
- excellent problem-solving abilities,
- a clear voice, and
- a good memory.

There are six steps in the selection process. The first step is to apply online (<http://takecharge.navcanada.ca>). After completing the application process, there are two online tests that must be taken. If the results from the online tests are favourable, the applicant will be contacted by NAV CANADA and invited to participate in an in-person assessment session. A \$200 assessment fee is charged for the in-person session. The testing during this session is more extensive and includes a variety of tests that measure:

- thinking and reasoning,
- communication,
- multi-tasking,
- attention,
- information processing,
- memory,
- motor ability,
- agreeableness,
- conscientiousness,
- emotional stability, and
- knowledge.

The most successful candidates from the in-person assessment sessions are invited to participate in a two-stage interview process. The first interview is conducted during a teleconference, and the second interview is conducted in person. Successful candidates from the interview process are placed on a roster for training. Candidates placed on the roster for training must undergo a medical exam and a security check. Following the medical exam and security check, candidates must then complete a 30–50 hour Introduction to Aviation online course prior to commencing the formal training process.

Training Process

The initial classroom training process for all three specialties is conducted at seven area control centres (ACCs). Candidates will be trained initially in the same area of the country that their on-the-job training (OJT) phase will be conducted.

Flight service specialists receive initial training of up to six months. The tuition for this phase is \$1 000. Upon completion of initial training, candidates move to the OJT phase and begin earning a training salary (approximately \$30 000 per year). OJT may last up to six months.

VFR air traffic controllers receive initial training of four to six months in duration. The tuition for this phase is \$2 500. Upon completion of initial training, candidates move to the OJT phase and begin earning a training salary (approximately \$33 000 per year). OJT will last for four to six months.

IFR air traffic controllers receive initial training of 7–14 months in duration. The tuition for this phase is \$3 500. Upon completion of initial training, candidates move to the OJT phase and begin earning a training salary (approximately \$33 000 per year). OJT will last for 6–12 months.



The assessment fee, tuition costs and training salaries are current as of April 2009.

GROUP DISCUSSION



TIPS FOR ANSWERING / FACILITATING DISCUSSION:

- Establish ground rules for discussion, eg, everyone should listen respectfully; don't interrupt; only one person speaks at a time; no one's ideas should be made fun of; you can disagree with ideas but not with the person; try to understand others as much as you hope they understand you; etc.
- Sit the group in a circle, making sure all cadets can be seen by everyone else.
- Ask questions that will provoke thought; in other words avoid questions with yes or no answers.
- Manage time by ensuring the cadets stay on topic.
- Listen and respond in a way that indicates you have heard and understood the cadet. This can be done by paraphrasing their ideas.
- Give the cadets time to respond to your questions.
- Ensure every cadet has an opportunity to participate. One option is to go around the group and have each cadet answer the question with a short answer. Cadets must also have the option to pass if they wish.
- Additional questions should be prepared ahead of time.

SUGGESTED QUESTIONS:

- Q1. What type of skills would a flight service specialist need?
- Q2. What type of skills would a VFR air traffic controller need?
- Q3. What type of skills would a IFR air traffic controller need?
- Q4. What aviation-specific knowledge would be needed for a career in ATC?

- Q5. Why would knowledge of meteorology be important for someone in a career in ATC?
- Q6. Why would knowledge of radio communication procedures be important for a career in ATC?
- Q7. What are the prerequisites for a career in ATC?
- Q8. What is the selection process for a career in ATC?
- Q9. What is the training process for a career in ATC?
- Q10. What type of post-secondary training would be helpful to someone looking for a career in ATC?



Other questions and answers will develop throughout the group discussion. The group discussion should not be limited to only those suggested.



Reinforce those answers given and comments made during the group discussion, ensuring the teaching points have been covered.

CONFIRMATION OF TEACHING POINT 2

The cadets' participation in the group discussion will serve as the confirmation of this TP.

END OF LESSON CONFIRMATION

The cadets' participation in the group discussion on ATC career opportunities will serve as the confirmation of this lesson.

CONCLUSION

HOMEWORK / READING / PRACTICE

Nil.

METHOD OF EVALUATION

Nil.

CLOSING STATEMENT

A variety of career opportunities exist in the ATC field. Part of the process of preparing for a career in this field is to describe the career opportunities. By describing the opportunities and discussing the skills, required training, and training institutes you may be able to decide if one of these careers is the one for you.

INSTRUCTOR NOTES / REMARKS

If available, a guest speaker from the field of air traffic control may be used for this lesson.

REFERENCES

C3-332 NAV CANADA. (2009). *Take charge of your career*. Retrieved February 23, 2009, from <http://takecharge.navcanda.ca>

THIS PAGE INTENTIONALLY LEFT BLANK



ROYAL CANADIAN AIR CADETS
PROFICIENCY LEVEL FOUR
INSTRUCTIONAL GUIDE



SECTION 3

EO C460.03 – DESCRIBE AIRPORT SECURITY CAREER OPPORTUNITIES

Total Time:

30 min

PREPARATION

PRE-LESSON INSTRUCTIONS

Resources needed for the delivery of this lesson are listed in the lesson specification located in A-CR-CCP-804/PG-001, *Proficiency Level Four Qualification Standard and Plan*, Chapter 4. Specific uses for said resources are identified throughout the instructional guide within the TP for which they are required.

Review the lesson content and become familiar with the material prior to delivering the lesson.

PRE-LESSON ASSIGNMENT

Have the cadets visit the Canadian Air Transport Security Authority (CATSA) web site (<http://www.catsa-acsta.gc.ca>) or provide handouts of the roles and responsibilities, and career opportunities sections of the web site at least one week prior to the lesson.

APPROACH

An in-class activity was chosen for TP 1 as it is an interactive way to provoke thought and stimulate interest among cadets.

A group discussion was chosen for TP 2 as it allows the cadets to interact with their peers and share their knowledge, experiences, opinions, and feelings on airport security career opportunities.

INTRODUCTION

REVIEW

Nil.

OBJECTIVES

By the end of this lesson the cadet shall be expected to describe airport security career opportunities.

IMPORTANCE

It is important for cadets to describe airport security career opportunities as airport security is an important and growing responsibility at airports. An ability to describe these career opportunities is an important step in the process of preparing cadets for aviation-related careers.

Teaching Point 1

Have the cadets brainstorm airport security career opportunities.

Time: 10 min

Method: In-Class Activity

ACTIVITY

OBJECTIVE

The objective of this activity is to have the cadets brainstorm a list of airport security career opportunities.

RESOURCES

- Flip chart paper, and
- Markers.

ACTIVITY LAYOUT

Nil.

ACTIVITY INSTRUCTIONS

1. Divide the cadets into groups of no more than three.
2. Distribute a piece of flip chart paper and a marker to each group.
3. Have each group brainstorm a list of airport security career opportunities.
4. Have each group present their list to the class.



Encourage the cadets to consider airport security career opportunities at various types of airports (eg, private, municipal, regional, national, international).

SAFETY

Nil.

CONFIRMATION OF TEACHING POINT 1

The cadets' participation in the activity will serve as the confirmation of this TP.

Teaching Point 2**Conduct a group discussion on airport security career opportunities.**

Time: 15 min

Method: Group Discussion

BACKGROUND KNOWLEDGE

The purpose of the group discussion is to draw the following information from the group using the tips for answering / facilitating discussion and the suggested questions provided.

AIRPORT SECURITY CAREER OPPORTUNITIES

Security at an airport is provided by a number of different agencies, each with specific areas of responsibilities and unique career opportunities within their areas of responsibilities.

Canadian Air Transport Security Authority (CATSA)

CATSA is responsible for the following areas:

- ensuring screening of passengers and non-passengers is conducted IAW regulations at major airports;
- acquiring, deploying, operating, inspecting, and maintaining explosive detection systems at designated airports;
- implementing a restricted area identification card system at major airports; and
- developing, implementing, and evaluating a training and certification program for screening officers.

Screening Contractors

Pre-board screening personnel are provided by security firms contracted by CATSA. A variety of firms across the country provide these services.

Screening Equipment Maintenance Contractors

These contractors are responsible for maintaining the screening and security equipment IAW applicable contracts and regulations. This includes calibration of equipment and documentation of maintenance and outages.

Air Carriers

Air carriers (eg, airlines) are responsible for the security of their operations, the security of baggage after it has been screened, and ensuring that dangerous goods are transported IAW applicable regulations.

Airport Operators

Airport operators are responsible for providing physical security measures for the airport facility, providing space for screening operations, and maintaining the restricted area identification card system.

Jurisdictional Police

The jurisdictional police force is responsible for responding to emergency and security-related incidents at the airport.

Transport Canada

Transport Canada is responsible for developing regulations and standards for airport security, granting security clearances as part of the restricted area identification card system, and auditing / inspecting the security operations at airports.

SKILLS AND TRAINING REQUIRED

The required skills and training vary widely depending on the specific career in airport security. The requirements common to most of the available careers in airport security are:

- being a Canadian resident for at least the last five years,
- being able to obtain a Transport Canada security clearance,
- being at least 18 years old,
- being a high school graduate,
- having excellent customer service skills,
- being able to handle stress, and
- being able to function autonomously.

TRAINING INSTITUTIONS

Career-specific training is usually handled directly by the employer, but any security-related post-secondary program is generally considered helpful to those looking for employment in the field of airport security. Many aviation programs (eg, aviation management and commercial pilot) also include a component on airport security.

GROUP DISCUSSION



TIPS FOR ANSWERING / FACILITATING DISCUSSION:

- Establish ground rules for discussion, eg, everyone should listen respectfully; don't interrupt; only one person speaks at a time; no one's ideas should be made fun of; you can disagree with ideas but not with the person; try to understand others as much as you hope they understand you; etc.
- Sit the group in a circle, making sure all cadets can be seen by everyone else.
- Ask questions that will provoke thought; in other words avoid questions with yes or no answers.
- Manage time by ensuring the cadets stay on topic.
- Listen and respond in a way that indicates you have heard and understood the cadet. This can be done by paraphrasing their ideas.
- Give the cadets time to respond to your questions.

- Ensure every cadet has an opportunity to participate. One option is to go around the group and have each cadet answer the question with a short answer. Cadets must also have the option to pass if they wish.
- Additional questions should be prepared ahead of time.

SUGGESTED QUESTIONS:

- Q1. What types of skills would a pre-board screening officer need?
- Q2. What types of skills and training would be common to any career in airport security?
- Q3. What aviation-specific knowledge would be needed to work in airport security?
- Q4. Why would knowledge of radio communication procedures be important for someone working in airport security?
- Q5. Which type of post-secondary training would be helpful to someone looking for a career in airport security?



Other questions and answers will develop throughout the group discussion. The group discussion should not be limited to only those suggested.



Reinforce those answers given and comments made during the group discussion, ensuring the teaching points have been covered.

CONFIRMATION OF TEACHING POINT 2

The cadets' participation in the group discussion will serve as the confirmation of this TP.

END OF LESSON CONFIRMATION

The cadets' participation in the group discussion on airport security career opportunities will serve as the confirmation of this lesson.

CONCLUSION

HOMEWORK / READING / PRACTICE

Nil.

METHOD OF EVALUATION

Nil.

CLOSING STATEMENT

A wide variety of career opportunities exist in the airport security field. Part of the process of preparing for a career in this field is to describe the career opportunities. By describing the opportunities and discussing the skills, required training, and training institutes you may be able to decide if one of these careers is the one for you.

INSTRUCTOR NOTES / REMARKS

If available, a guest speaker from the field of airport security may be used for this lesson.

REFERENCES

C3-309 Avjobs.com. (2009). *Aviation career overviews*. Retrieved February 9, 2009, from <http://www.avjobs.com/careers/index.asp>

C3-316 Canadian Air Transport Security Authority. (2008). *Screening officers – Roles and responsibilities*. Retrieved February 10, 2009, from <http://www.catsa-acsta.gc.ca/so-ac/english/roles/>

C3-317 Canadian Air Transport Security Authority. (2009). *Employment opportunities*. Retrieved February 10, 2009, from http://www.catsa-acsta.gc.ca/english/about_propos/opp/index.cfm



ROYAL CANADIAN AIR CADETS
PROFICIENCY LEVEL FOUR
INSTRUCTIONAL GUIDE



SECTION 1

EO C470.01 – DISCUSS AIRCRAFT MANUFACTURERS

Total Time:

30 min

PREPARATION

PRE-LESSON INSTRUCTIONS

Resources needed for the delivery of this lesson are listed in the lesson specification located in A-CR-CCP-804/PG-001, *Proficiency Level Four Qualification Standard and Plan*, Chapter 4. Specific uses for said resources are identified throughout the instructional guide within the TP for which they are required.

Review the lesson content and become familiar with the material prior to delivering the lesson.

Prepare the list of international partnerships located at Attachment A by photocopying the list and cutting the sections apart to distribute to the cadets.

Photocopy the International Partnership Summary Sheet located at Attachment B for each cadet.

Photocopy the Unmanned Aerial Vehicle (UAV) Manufacturers Worksheet located at Attachment C for each cadet.

UAVs are continuously changing. The information presented in Reference C3-324 may be used as a starting point in researching current UAVs and UAV manufacturers. Research current UAVs and UAV manufacturers and collect information on two or three UAVs from newspapers, magazines, journals or websites to present in TP 2. The *Aircraft* page on the Air Force website (<http://www.airforce.gc.ca>) may include information on UAVs used by the Canadian Forces.

PRE-LESSON ASSIGNMENT

At least one week before the lesson, assign each cadet (or have each cadet select) an international partnership from the list of international partnerships located at Attachment A. Distribute an International Partnership Summary Sheet located at Attachment B to each cadet. Have the cadets review and research the international partnership details and prepare a short oral presentation (approximately 2–5 minutes) using the International Partnership Summary Sheet located at Attachment B.

APPROACH

An in-class activity was chosen for TP 1 as it is an interactive way to provoke thought and stimulate interest among cadets.

An interactive lecture was chosen for TP 2 to identify UAV manufacturers.

INTRODUCTION

REVIEW

Nil.

OBJECTIVES

By the end of this lesson the cadet shall have discussed international partnerships between aircraft manufacturers and identified UAV manufacturers.

IMPORTANCE

It is important for cadets to discuss international partnerships between aircraft manufacturers as Canada is a leading exporter of advanced technology and is the fourth largest producer of civil aircraft in the world. It is important for cadets to identify UAV manufacturers as UAVs are a relatively new technology and are rapidly becoming more important in aviation, especially military aviation.

Teaching Point 1

Conduct an activity where the cadets will review a summary of an international partnership between aircraft manufacturers and make a short oral presentation on the international partnership.

Time: 20 min

Method: In-Class Activity

ACTIVITY**OBJECTIVE**

The objective of this activity is have the cadets review a summary of an international partnership between aircraft manufacturers and make a short oral presentation on the international partnership.

RESOURCES

- Pen / pencil,
- List of international partnerships located at Attachment A, and
- International Partnership Summary Sheet located at Attachment B.

ACTIVITY LAYOUT

Nil.

ACTIVITY INSTRUCTIONS

Have each cadet make a short oral presentation (approximately 2–5 minutes) to the group on their selected / assigned international partnership using the information they have recorded on the International Partnership Summary Sheet.



If there is not enough time for all the cadets to make their presentations, the cadets can be divided into two or more groups.

SAFETY

Nil.

CONFIRMATION OF TEACHING POINT 1

The cadets' participation in the activity will serve as the confirmation of this TP.

Teaching Point 2

Identify UAV manufacturers.

Time: 5 min

Method: Interactive Lecture



Distribute an Unmanned Aerial Vehicles (UAV) Manufacturers Worksheet located at Attachment C to each cadet.



Present the information collected on the UAVs to the cadets and have the cadets make notes using the Unmanned Aerial Vehicles (UAV) Manufacturers Worksheet.

CONFIRMATION OF TEACHING POINT 2

The cadets' completion of the Unmanned Aerial Vehicles (UAV) Manufacturers Worksheet will serve as the confirmation of this TP.

END OF LESSON CONFIRMATION

The cadets' participation in presenting the information on an international manufacturing partnership will serve as the confirmation of this lesson.

CONCLUSION

HOMEWORK / READING / PRACTICE

Nil.

METHOD OF EVALUATION

Nil.

CLOSING STATEMENT

Canada is one of the world's leading suppliers of aviation technology. International partnerships between Canadian aviation manufacturers and those in other countries results in 85 percent of the aviation production being sold internationally. The use of UAVs, especially in military aviation, is growing rapidly and the manufacturing of UAVs is becoming an important sector in aviation manufacturing.

INSTRUCTOR NOTES / REMARKS

Cadets who are qualified Advanced Aviation Technology – Aircraft Manufacturing and Maintenance may be able to assist with this lesson.

REFERENCES

- C3-321 ISBN 978-2-921393-91-1 Bombardier Inc. (2009). *Canada's Bombardier*. Canada: Bombardier Inc.
- C3-322 Government of Canada. (2008). *Canada's aerospace advantages*. Retrieved February 10, 2009 from <http://investincanada.gc.ca/eng/industry-sectors/advanced-manufacturing/aerospace/aerospace-advantages.aspx>
- C3-323 Industry Canada. (2009). *Aerospace in Canada*. Retrieved February 10, 2009 from <http://www.ic.gc.ca/eic/site/ad-ad.nsf/eng/ad03909.html>
- C3-324 Thirty Thousand Feet Aviation Directory. (2009). *Unmanned aerial vehicles*. Retrieved February 10, 2009, from <http://www.thirtythousandfeet.com/uav.htm>

THIS PAGE INTENTIONALLY LEFT BLANK

International Partnerships

After photocopying, cut the list apart on the dotted lines and distribute as required to the cadets.

Pratt & Whitney Canada

- Pratt & Whitney Canada is an aerospace leader committed to shaping the future of business, general aviation, and regional aircraft and helicopters with high-performing, dependable engines.
- A new 10 000-pound thrust class engine family was selected by Cessna Aircraft for the Citation Columbus business jet and will exceed International Civil Aviation Organization (ICAO) emissions standards by up to 50 percent.

Bombardier Aerospace

- Bombardier's regional airliner product family includes the CRJ series regional jets and the Q series turboprop.
- Bombardier is the world's third largest civil aircraft manufacturer with locations in 22 countries and customers in more than 100 countries.

Goodrich and Messier-Dowty

- The landing gear market is the undisputed domain of Canadian industry.
- Goodrich is the chosen supplier of components for the Airbus A380 landing gear. Messier-Dowty supplies landing gear for the Boeing 787.

ExelTech Aerospace

- ExelTech Aerospace is the largest regional aircraft maintenance, repair, and overhaul (MRO) in North America and services such types as the Bombardier CRJ, Embraer ERJ, ATR-42, ATR-72, Boeing 737, and Saab 340.

Magellan, Honeywell, and Avcorp

- The Joint Strike Fighter (JSF) program has nine different nations as partners: the United States, the United Kingdom, Italy, the Netherlands, Turkey, Canada, Denmark, Norway, and Australia.
- Several Canadian companies supply components and systems to the JSF including Magellan (primary flight and propulsion structures), Honeywell (power management system), and Avcorp (outboard wings).

.....

CAE

- CAE is a world leader in simulation and training services for civil and military aviation.
- Through its global network of 27 civil and military aviation training centres, CAE trains more than 75 000 crew members annually.

Thales

- Thales is a world leader in mission-critical information systems for aviation, defence, and security markets with operations in 50 countries.
- Their headquarters is in Montreal and it is the worldwide centre of excellence for flight control systems.

CMC Electronics

- CMC Electronics provides innovative cockpit systems integration and avionics to customers worldwide.
- CMC is the prime contractor for the avionics systems integration of the Beechcraft T-6B military trainer aircraft.

Magellan Aerospace Corporation

- Magellan Aerospace Corporation has locations in Canada, the United States, the United Kingdom, and India.
- Magellan designs, manufactures, and repairs aeroengine and aerostructure components and assemblies.

Avcorp

- Avcorp produces high-strength interior panels, fuel tanks, structural wing components, and fully integrated vertical and horizontal stabilizers.
- Avcorp is providing primary flight structures for the Cessna Sovereign and Citation CJ3 business jets.

Standard Aero

- Standard Aero is among the largest small-turbine engine maintenance and repair companies in the world, providing MRO services for General Electric, Rolls-Royce, Honeywell and P&WC engines.

International Partnership Summary Sheet

Companies and Countries Involved
Aircraft Types and / or Components Involved
Additional Information

THIS PAGE INTENTIONALLY LEFT BLANK

Unmanned Aerial Vehicle (UAV) Manufacturers Worksheet

UAV Name	Manufacturer Name and Country of Manufacture	Purpose(s)

THIS PAGE INTENTIONALLY LEFT BLANK



**ROYAL CANADIAN AIR CADETS
PROFICIENCY LEVEL FOUR
INSTRUCTIONAL GUIDE**



SECTION 2

EO C470.02 – DISCUSS AIRCRAFT ASSEMBLY

Total Time:	30 min
-------------	--------

PREPARATION

PRE-LESSON INSTRUCTIONS

Resources needed for the delivery of this lesson are listed in the lesson specification located in A-CR-CCP-804/PG-001, *Proficiency Level Four Qualification Standard and Plan*, Chapter 4. Specific uses for said resources are identified throughout the instructional guide within the TP for which they are required.

Review the lesson content and become familiar with the material prior to delivering the lesson.

Create slides of the Figures located at Attachments A and B.

Cue *The World's Biggest Airliner: The Airbus A380* DVD to the first chapter, *Toulouse, France* (seven minutes).

PRE-LESSON ASSIGNMENT

Nil.

APPROACH

An interactive lecture was chosen for this lesson to introduce aspects of aircraft assembly methods and give an overview of them.

INTRODUCTION

REVIEW

Nil.

OBJECTIVES

By the end of this lesson the cadet shall have discussed the assembly of aircraft components in a manufacturing setting.

IMPORTANCE

It is important for the cadets to learn about aircraft assembly methods because this will enhance their understanding of aircraft and the field of aviation.

Teaching Point 1**Describe different methods of assembly of components.**

Time: 15 min

Method: Interactive Lecture

SMALL MANUFACTURERS

For an aircraft to fly correctly, the main structural components, such as fuselage, wings, engines and empennage parts must be aligned perfectly. Any deviation or flaw, such as a twist in any component, will impair flight and have a negative effect on flight controls. Cranes hold the heavy parts in place, jigs and templates position them precisely. The development of techniques for measuring and positioning components on the structure to a high degree of accuracy have been developed, as aircraft have become heavier and faster.

LARGE MANUFACTURERS

Some aircraft are now so large that cranes cannot lift and hold the parts satisfactorily. Special carriers are custom-built to hold the parts, while computer control is used to bring them together. Lasers measure distances and angles with the use of mirrors, and send the data to high-speed computers. By using these methods, the fuselage, wings and empennage components can be assembled precisely, no matter how large they are.

Not all aircraft components are structural. A company such as Bombardier Aerospace has hundreds of suppliers that provide everything from horizontal stabilizers to airspeed indicators. All of these components fit and work together as a result of a process called Systems Integration. The aerospace engineers designing the aircraft must ensure that physical components and associated software programs work together.



Show the cadets the first chapter *Toulouse France* of *The World's Biggest Airliner: The Airbus A380*. This section covers the use of mirrors and an infrared laser positioning system and shows the fuselage components being joined.

CONFIRMATION OF TEACHING POINT 1**QUESTIONS:**

- Q1. Why must an aircraft's structural components be aligned perfectly?
- Q2. For large aircraft, what type of control is used to bring the structural parts together?
- Q3. What is the name of the process that aeronautical engineers use to integrate separate systems?

ANTICIPATED ANSWERS:

- A1. Any deviation or flaw will impair flight and have a negative effect on flight controls.
- A2. Computer control.
- A3. Systems Integration.

Teaching Point 2**Discuss manufacturers' assembly areas.**

Time: 10 min

Method: Interactive Lecture

A SMALL MANUFACTURER'S SHOP

Small manufacturers can often perform all necessary operations in one location like Viking Air, which manufactures the new 400 series Twin Otter and remanufactures Beaver and Otter aircraft near the Victoria International Airport in Sydney, British Columbia. A small manufacturer's shop is characterized by all the aircraft parts and materials coming together at one manufacturing plant prior to final assembly. All necessary machinery and facilities are provided, sometimes under one roof. Manufacturing encompasses all phases of assembly from sheet metal bending, engine assembly, avionics and final painting and interior finish.



Viking Air is considered a small manufacturer's shop. They manufacture, assemble, modify, and repair aircraft.

A LARGE MANUFACTURER'S ASSEMBLY LINE

All manufacturers need machines to move large, heavy components such as wings and to control their motion with precision. In the assembly areas of large aircraft, these machines are also large.



Show the cadets the series of assembly area photographs located at Attachment A.



Larger manufacturers generally have more career specialization than smaller ones, such as engine, airframe or avionics specialization. Small manufacturers have fewer employees, so they need their employees to be able to handle more related fields.

Large manufacturers such as Bombardier Aerospace have facilities around the world. The materials and components for the basic aircraft structure are gathered at one assembly plant, such as Downsview in Toronto, Ontario. This plant is responsible for the final assembly of structural components for the Learjet 45 aircraft, the Q-Series turboprops and the Global family of business aircraft. The facility occupies 324 acres of land and has almost two million square feet of building floor space. At Dorval, Quebec, Bombardier has a completion facility with 31 345 square metres (337 400 square feet), housing up to 14 Global Express aircraft and a delivery centre in which customers can choose design options in a virtual reality environment. The finishing touches, such as cabin furnishings, are installed here. A separate 7 246 square metre (78 000 square foot) paint and strip shop is located next to the completion centre, capable of housing up to four aircraft at a time.

Another 38 591 square metre (415 400 square foot) facility is located in Dorval, near the Bombardier Aerospace administrative centre and the Canadair aircraft assembly plant.

Airbus has an even larger operation. The A380 is assembled and delivered in Europe and has major structural components made in Australia, Canada, England, Finland, France, Germany, Italy, Malaysia, Mexico, Morocco, Russia, Spain, Turkey and the USA.

Suppliers, for both structural and minor components, are located around the world:

Australia	Wingtip fences	Mexico	Very large size special Hi-Lite® pull-in bolts
Canada	Pratt & Whitney Canada: Auxiliary power unit; and Goodrich: Body and wing landing gear	Morocco	Ducts for the air distribution system
England	Wings	Russia	Materials—titanium, aluminum, magnesium alloys and steel
Finland	Lift spoilers	Spain	Lateral boxes of the horizontal tail plane, the main landing gear doors, sections of the rear fuselage of the aircraft and the vertical stabilizer
France	France is the centre of A380 production	Sweden	Fixed leading edge from inner engine installation to wing tip. This includes wing spar, rib assemblies, system installation brackets and both inner and outer pylon fixed structures
Germany	Fuselage fabrication / assembly, aircraft finishing, waste water systems	Turkey	Large size special Hi-Lite® pull-in bolts of up to 28.5 mm (one inch) diameter, in both titanium and high-strength alloys, for the assembly of the most critical high-fatigue structural areas like wing spars, centre wing box and wing-to-fuselage junction
Italy	Central fuselage	USA	Airbus has an engineering design centre in Wichita, Kansas and many suppliers in the USA
Malaysia	Fixed leading edge lower panels and inboard outer fixed leading edge of wings	These are only the main supplier relationships that Airbus has developed around the world.	

Figure 1 Airbus A380 World-Wide Suppliers

Note. Created by Director Cadets 3, 2009, Ottawa, ON: Department of National Defence.



Show the cadets Figures B-1 to B-6 located at Attachment B. These pictures indicate the significance of the pylon fixed structures and pylon brackets that mount the four engines to the A380 wing. Each engine develops 31 750 kg (70 000 lbs) of thrust against the titanium pylons which transfer the thrust to the aircraft's wing.



Show the cadets Figure B-7 located at Attachment B, which lists Airbus A380 suppliers in North America.



For more information about how an A380 is made, the cadets can visit the Airbus Navigator at web page <http://events.airbus.com/A380/Default2.aspx?ArtId=644> or visit the Airbus website at www.airbus.com.

CONFIRMATION OF TEACHING POINT 2**QUESTIONS:**

- Q1. What characterizes a small manufacturer's shop?
- Q2. Where are large manufacturers located?
- Q3. What happens at a large manufacturer's completion facility?

ANTICIPATED ANSWERS:

- A1. All the aircraft parts and materials come together at one place prior to final assembly.
- A2. Around the world.
- A3. The finishing touches, such as cabin furnishings, are installed.

END OF LESSON CONFIRMATION**QUESTIONS:**

- Q1. Why must an aircraft's structural components be aligned perfectly?
- Q2. What happens at a large manufacturer's completion facility?
- Q3. What is different with respect to career specialization between large and small manufacturers?

ANTICIPATED ANSWERS:

- A1. Any deviation or flaw will impair flight and have a negative effect upon flight controls.
- A2. The finishing touches, such as cabin furnishings, are installed.
- A3. Larger manufacturers generally have more career specialization than smaller ones.

CONCLUSION

HOMEWORK / READING / PRACTICE

Nil.

METHOD OF EVALUATION

Nil.

CLOSING STATEMENT

Precise assembly of large structures is a difficult yet critically important aspect of aircraft manufacturing, which benefits from continued development and improved techniques.

INSTRUCTOR NOTES / REMARKS

The cadets may have previously viewed The World's Biggest Airliner: The Airbus A380 if EO C270.04 was selected in Proficiency Level Two. This lesson focuses and expands on the assembly of aircraft.

Cadets who are qualified Advanced Aviation Technology – Aircraft Manufacturing and Maintenance may be able to assist with this lesson.

REFERENCES

C3-105 Brisley, T., & Pascaud, S. (Executive Producer), & Bowie, B. (Writer / Director) (2003). *World's biggest airliner: The Airbus A380* [Motion Picture]. United States: The Learning Channel.

C3-136 ISBN 0-88487-207-6 Sanderson Training Systems. (2001). *A&P technician airframe textbook*. Englewood, CO: Jeppesen Sanderson Inc.



Figure A-1 Rebuilding a C-130 Centre Wing

Note. From "L3 Communications Limited", 2007, *SPAR Aerospace: Globally Competitive Aerospace Solutions*. Retrieved October 23, 2007, from <http://www.spar.ca/>



Figure A-2 Placing a C-130 Centre Wing

Note. From "L3 Communications Limited", 2007, *SPAR Aerospace: Globally Competitive Aerospace Solutions*. Retrieved October 23, 2007, from <http://www.spar.ca/>



Figure A-3 Positioning a C-130 Centre Wing

Note. From "L3 Communications Limited", 2007, *SPAR Aerospace: Globally Competitive Aerospace Solutions*. Retrieved October 23, 2007, from <http://www.spar.ca/>



Figure A-4 Bombardier QR 400 Fuselage Assembly

Note. From "Media Centre", by Bombardier Aerospace, 2007, *QR 400 Assembly*. Retrieved November 1, 2007, from http://www.bombardier.com/MediaCenter/Multimedia?action=view&gid=3_0&cid=295&page=1&Language=en



Figure A-5 Bombardier QR 400 Wing Assembly

Note. From "Media Centre", by Bombardier Aerospace, 2007, *QR 400 Assembly*. Retrieved November 1, 2007, from http://www.bombardier.com/MediaCenter/Multimedia?action=view&gid=3_0&cid=295&page=1&Language=en



Figure A-6 Bombardier QR 400 Assembly Line

Note. From "Media Centre", by Bombardier Aerospace, 2007, *QR 400 Assembly*. Retrieved November 1, 2007, from http://www.bombardier.com/MediaCenter/Multimedia?action=view&gid=3_0&cid=295&page=1&Language=en



Figure A-7 Bombardier QR 400 Assembly Activity

Note. From "Media Centre", by Bombardier Aerospace, 2007, *QR 400 Assembly*. Retrieved November 1, 2007, from http://www.bombardier.com/MediaCenter/Multimedia?action=view&gid=3_0&cid=295&page=1&Language=en



Figure A-8 Bombardier QR 400 Engine Assembly

Note. From "Media Centre", by Bombardier Aerospace, 2007, *QR 400 Assembly*. Retrieved November 1, 2007, from http://www.bombardier.com/MediaCenter/Multimedia?action=view&gid=3_0&cid=295&page=1&Language=en



Figure A-9 Bombardier CRJ700 Fuselage Assembly

Note. From "Media Centre", by Bombardier Aerospace, 2007, *CRJ700 Assembly*. Retrieved November 1, 2007, from http://www.bombardier.com/MediaCenter/Multimedia?action=view&gid=3_0&cid=295&page=1&Language=en



Figure A-10 Bombardier CRJ700 Assembly Line

Note. From "Media Centre", by Bombardier Aerospace, 2007, *CRJ700 Assembly*. Retrieved November 1, 2007, from http://www.bombardier.com/MediaCenter/Multimedia?action=view&gid=3_0&cid=295&page=1&Language=en



Figure A-11 Bombardier CRJ700 Assembly

Note. From "Media Centre", by Bombardier Aerospace, 2007, *CRJ700 Assembly*. Retrieved November 1, 2007, from http://www.bombardier.com/MediaCenter/Multimedia?action=view&gid=3_0&cid=295&page=1&Language=en



Figure A-12 A Q400 Fuselage Arrives from MHI, Japan

Note. From "Media Centre", by Bombardier Aerospace, 2007, *QR 400 Assembly*. Retrieved November 1, 2007, from http://www.bombardier.com/MediaCenter/Multimedia?action=view&gid=3_0&cid=295&page=1&Language=en



Figure B-1 Building a Pylon

Note. From "A380 Navigator", by Airbus, 2007, *Manufacturing Process*. Retrieved November 24, 2007, from <http://events.airbus.com/A380/Default2.aspx?ArtId=644>



Figure B-2 Pylon Ready to Go

Note. From "A380 Navigator", by Airbus, 2007, *Manufacturing Process*. Retrieved November 24, 2007, from <http://events.airbus.com/A380/Default2.aspx?ArtId=644>



Figure B-3 Pylon on Display

Note. From "A380 Navigator", by Airbus, 2007, *Manufacturing Process*. Retrieved November 24, 2007, from <http://events.airbus.com/A380/Default2.aspx?ArtId=644>



Figure B-4 Empty Pylons

Note. From "A380 Navigator", by Airbus, 2007, *Manufacturing Process*. Retrieved November 24, 2007, from <http://events.airbus.com/A380/Default2.aspx?ArtId=644>



Figure B-5 Engines on Pylons

Note. From "A380 Navigator", by Airbus, 2007, *Manufacturing Process*. Retrieved November 24, 2007, from <http://events.airbus.com/A380/Default2.aspx?ArtId=644>



Figure B-6 A380 with Engines

Note. From "A380 Navigator", by Airbus, 2007, *Manufacturing Process*. Retrieved November 24, 2007, from <http://events.airbus.com/A380/Default2.aspx?ArtId=644>



Figure B-7 Pylons at Work

Note. From "A380 Navigator", by Airbus, 2007, *Manufacturing Process*. Retrieved November 24, 2007, from <http://events.airbus.com/A380/Default2.aspx?ArtId=644>

L-3 COMMUNICATIONS AVIATION RECORDERS

L-3 Communications Aviation Recorders (L-3AR) provides the flight data recorder and cockpit voice recorder for the A380.

ROCKWELL COLLINS

Rockwell Collins' suite of communication and navigation sensors provides the baseline for the A380.

ALCOA

Alcoa supplies forgings, extrusions, sheet, plate, and castings for the A380's wing and fuselage skins, stringers, frames, spars, gear ribs, engine and pylon support, seat tracks and floor beams.

C&D AEROSPACE

California-based C&D Aerospace provides aircraft interior systems for the A380.

CYTEC - ENGINEERED MATERIALS

Cytec Engineered Materials produces composites, adhesives and carbon fibres.

EATON CORPORATION

US-based Eaton Corporation supplies the A380 with a highly-advanced higher-pressure hydraulic fluid power generation system, the world's first 5000-psi pump for a commercial aircraft.

HONEYWELL AEROSPACE

Honeywell Aerospace will deliver 12 products and systems for the A380.

M.C.GILL CORPORATION

M.C. Gill Corporation provides fully equipped composite floor panels for the cockpit of the A380, the main electronics bay situated below the cockpit and the emergency electronics bay, which sits forward of the upper deck passenger cabin.

MEGGITT SAFETY SYSTEMS

Meggitt Safety Systems Inc.(MSSI) supplies the fire detection systems for the A380's engines, auxiliary power units (APUs) and main landing gears.

MONOGRAM SYSTEMS

Monogram Systems, a unit of Zodiac's airline equipment branch in California, supplies an advanced water and vacuum waste system for the A380 that will incorporate state-of-the-art technical innovations.

NORTHROP GRUMMAN

The navigation systems division of US defence company Northrop Grumman supplies the A380 with its LTN-101E global navigation air data inertial reference unit.

PARKER

Parker Aerospace, a business unit of the Parker Hannifin Corporation, is participating in several work packages for the A380.

RALEE

Ralee Engineering Company, a Triumph Group company based in California, supplies the wing top skin stringers (the metal structure that goes under the wing panels) for the A380.

Figure B-8 Airbus A380 North American Suppliers

Note. Created by Director Cadets 3, 2007, Ottawa, ON: Department of National Defence.

THIS PAGE INTENTIONALLY LEFT BLANK



ROYAL CANADIAN AIR CADETS
PROFICIENCY LEVEL FOUR
INSTRUCTIONAL GUIDE



SECTION 3

EO C470.03 – IDENTIFY AVIATION HARDWARE

Total Time:

30 min

PREPARATION

PRE-LESSON INSTRUCTIONS

Resources needed for the delivery of this lesson are listed in the lesson specification located in A-CR-CCP-804/PG-001, *Proficiency Level Four Qualification Standard and Plan*, Chapter 4. Specific uses for said resources are identified throughout the instructional guide within the TP for which they are required.

Review the lesson content and become familiar with the material prior to delivering the lesson.

The activity in TP 1 uses learning stations. Learning stations are a form of group work, where the cadets learn by sorting through the information presented. When setting up learning stations, ensure there is enough room for each cadet to be comfortable and adequate space for writing down information. When the cadets arrive at a learning station, all required information shall be available. These stations should be placed closely together to minimize time for movement; however, far enough apart to avoid interruptions from other groups. For this lesson, set up four learning stations for aviation hardware.

Photocopy the Aviation Hardware Handout located at Attachment A (one per cadet), Aviation Hardware Information Sheets located at Attachments B–E (one attachment per station), and the Aviation Hardware Identification Worksheet located at Attachment F (one per cadet).

PRE-LESSON ASSIGNMENT

Nil.

APPROACH

An in-class activity was chosen for this lesson as it is an interactive way to provoke thought and stimulate interest among cadets.

INTRODUCTION

REVIEW

Nil.

OBJECTIVES

By the end of this lesson the cadet shall have identified aviation hardware.

IMPORTANCE

It is important for cadets to be able to identify aviation hardware as each type of hardware has a specific application. Using the correct type of aviation hardware during maintenance activities and the manufacturing of aircraft and aircraft components ensures that the design specifications and safety tolerances are maintained. Using the incorrect type of aviation hardware could jeopardize the safety of the aircrew, passengers, and personnel on the ground.

Teaching Point 1**Conduct an activity where the cadets will identify aviation hardware.**

Time: 25 min

Method: In-Class Activity

ACTIVITY**OBJECTIVE**

The objective of this activity is to have the cadets identify aviation hardware.

RESOURCES

- Pen / pencil,
- Aviation Hardware Handout located at Attachment A,
- Aviation Hardware Information Sheets located at Attachments B–E,
- Aviation Hardware Identification Worksheet located at Attachment F, and
- Aviation Hardware Identification Worksheet Answer Key located at Attachment G.

ACTIVITY LAYOUT

If samples of aviation hardware are available, place them at the appropriate learning station.

ACTIVITY INSTRUCTIONS

1. Brief cadets on activity instructions, to include:
 - a. time limit for each station (five minutes),
 - b. direction of rotation between stations,
 - c. signal for rotation,
 - d. explanation of Aviation Hardware Information Sheets, and
 - e. an overview of the Aviation Hardware Identification Worksheet.
2. Distribute the Aviation Hardware Identification Worksheet located at Attachment F (to each cadet).
3. Divide the cadets into four groups and assign a number to each group.
4. Have groups move to the learning station which corresponds to their group number.
5. Have the cadets complete the Aviation Hardware Identification Worksheet while rotating from station to station every five minutes.

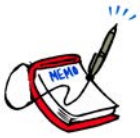

It is important to circulate around the room to facilitate the activities and help the cadets as required. If possible, assign other instructors to aid with the supervision and facilitation.

6. Once each group has been to each station, have one cadet from each group share the information they recorded from the station they just completed with the rest of the cadets. In most cases, the groups will have recorded the same information for each station. If a group has listed different information, have them share their answers.

SAFETY

Nil.

CONFIRMATION OF TEACHING POINT 1

The cadets' participation in the activity will serve as the confirmation of this TP.

END OF LESSON CONFIRMATION

The cadets' completion of the Aviation Hardware Identification Worksheet will serve as the confirmation of this lesson.

CONCLUSION

HOMEWORK / READING / PRACTICE

Nil.

METHOD OF EVALUATION

Nil.

CLOSING STATEMENT

Aviation hardware comes in a variety of types, each with a specific application. Using the correct type of aviation hardware during the manufacture and maintenance of aircraft and aircraft components is important to ensure that the safety of the aircrew, passengers, and personnel on the ground is not compromised.

INSTRUCTOR NOTES / REMARKS

Cadets who are qualified Advanced Aviation Technology – Aircraft Manufacturing and Maintenance may be able to assist with this lesson.

REFERENCES

C3-136 ISBN 0-88487-207-6 Sanderson Training Systems. (2001). *A&P technician airframe textbook*. Englewood, CO: Jeppesen Sanderson Inc.

C3-137 ISBN 0-88487-203-3 Sanderson Training Systems. (2000). *A&P technician general textbook*. Englewood, CO: Jeppesen Sanderson Inc.

Aviation Hardware Handout

Aviation hardware refers to the different types of fasteners and small items used during the manufacture and maintenance of aircraft and aircraft components. Although many of these items are small in size, their importance is large.

With more than 30 000 different fasteners available for aviation applications, it is important to be able to identify the different types of aviation hardware as their correct use is paramount for the safe and efficient operation of aircraft.

Aviation hardware comes in a variety of shapes and sizes, as well as in a variety of materials. Over the years, there have been many different ways to standardize the description of aviation hardware.

AMS (Aeronautical Material Specifications)	AN (Air Force–Navy)
AND (Air Force–Navy Design)	AS (Aeronautical Standard)
ASA (American Standards Association)	ASTM (American Society for Testing and Materials)
MS (Military Standard)	NAF (Naval Aircraft Factory)
NAS (National Aerospace Standard)	SAE (Society of Automotive Engineers)

Figure A-1 Aviation Hardware Specifications and Standards Codes

Note. From *A&P Technician General Textbook* (p. 8-2), by Jeppesen Standard Training Products, 2000, Englewood, CO: Jeppesen Sanderson Training Systems.

The two most common specification and standard identification systems used in aviation today are the Air Force–Navy (AN) and Military Standards 20 (MS20) systems. Both systems use a similar coding method to describe the physical characteristics of aviation hardware (eg, rivets, bolts, nuts, etc). An example of this is shown in Figure A-2. While there are minor differences between different systems, the same piece of hardware can be described by different systems (eg, an AN365 self-locking nut is the same as a MS20365 self-locking nut).

Rivet Designation	Physical Characteristics	
AN470-AD4-5	AN	Specification and standard (Air Force–Navy system)
	470	Head style (universal head)
	AD	Material code (2117 aluminum alloy)
	4	Diameter (4/32 inch)
	5	Length (5/16 inch)

Figure A-2 Rivet Specification Decoded

Note. Created by Director Cadets 3, 2009, Ottawa, ON: Department of National Defence.

Although there are many different types of fasteners used in aviation, there are five main categories:

- bolts (includes washers and nuts),
- rivets,
- special fasteners,

- machine screws, and
- turnlock fasteners.

Each category has its own unique terminology, although some terms may have similar meanings, as well as special tools and procedures for installation and removal.

Fasteners are used in two distinct applications in aviation: structural and non-structural. When used as a structural fastener, it is especially important that the correct hardware is used as the hardware forms part of the structure of the aircraft and is expected to be able to carry a specific load without failing.

Examples of structural fasteners include:

- bolts connecting the wing spar to the fuselage,
- rivets connecting the wing skin to the wing ribs, and
- bolts connecting the landing gear to the fuselage.

Examples of non-structural fasteners include:

- turnlock fasteners on inspection covers and cowlings,
- machine screws on interior panels, and
- bolts holding instruments in place in the instrument panel.

Aircraft plans, parts manuals, and repair manuals all include very specific details on the exact type of aviation hardware to be used. Builders and maintenance personnel must not substitute alternate hardware without ensuring that design specifications are not compromised.

When compared to standard or automotive hardware, aviation hardware is manufactured to higher standards, generally has a higher strength rating, and may come with a variety of finish or coating option. While non-aviation hardware may be legal for use on home-built aircraft, most associations strongly recommend the use of aviation hardware.

BOLTS

A bolt is designed to hold two or more items together. Bolts come in a variety of sizes, shapes, materials and strengths so that the correct fastener can be used for each application. Bolts are used for both structural and non-structural applications.

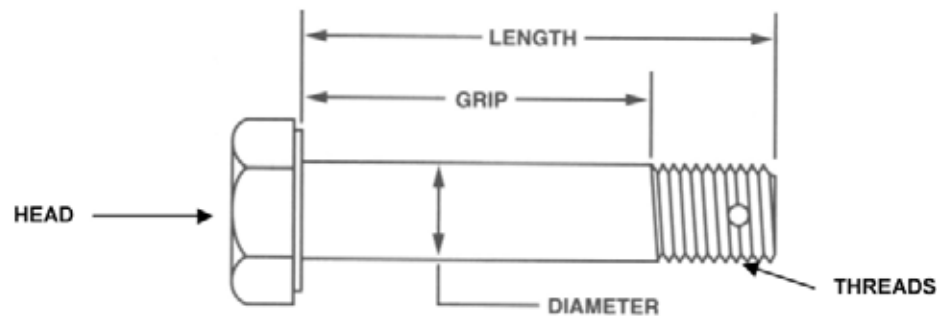

Figure B-1 AN (Airforce Navy) Bolt Dimensions

Note. From *A&P Technician General Textbook* (p. 8-17), by Jeppesen Standard Training Products, 2000, Englewood, CO:Jeppesen Sanderson Training Systems.

Standard AN Bolt Classification

Standard bolts classified using the AN system, are classified using the diameter and length, and additional modifiers (eg, material, drilled holes) are added. Diameters are indicated in 1/16-inch increments and length in 1/8-inch increments.

For example, an AN4-7 bolt has a diameter of 4/16 inch (1/4 inch) and a length of 7/8 inch. The length of the bolt is also known as the dash number. Dash numbers of eight and nine (-8 and -9) are not used. This means that a bolt length of 1 inch is represented with -10 (2 inches is -20, 3 inches is -30). For example, an AN5-22 bolt has a diameter of 5/16 inch and is 2-2/8 inches long (2-1/4 inches).

The material used for the bolt is indicated by replacing the dash with letters to indicate the material (the dash indicates that the bolt is made of cadmium-plated nickel steel). A corrosion-resistant bolt is represented with the letter C. Aluminum alloy bolts use the letters DD.

Standard bolts have a hole drilled in the threaded portion for a cotter pin (to keep the nut from coming off). To indicate a bolt without a hole, the letter A is added to the end of the bolt number (eg, AN5-22A). To indicate a bolt that has a hole drilled in the head (for locking wire), the letter H is inserted after the diameter (eg, AN6H34).

Threads

Threads are classified by the number of threads per inch (the number of times the threads rotate [number of turns] around a 1-inch length of a given diameter bolt or screw). Different standards for threads are American National Coarse (NC), American National Fine (NF), American Standard Unified Coarse (UNC), and American Standard Unified Fine (UNF).

Threads are also designated by the class of fit (from one to five). A Class 1 thread is a loose fit (the nut may be turned all the way from start to finish with just your fingers). A Class 5 thread is a tight fit (the nut requires a wrench from start to finish). Most aviation bolts are fine threaded with a Class 3 fit.

Nuts and Washers

Nuts are threaded onto the end of the bolt to prevent it from coming out. In some applications, the nut may also carry a load. Due to the vibrations experienced in a typical aircraft, most nuts must be locked onto the bolts. To keep the nut from coming loose, a cotter pin can be inserted through the hole in the bolt (a castle nut is used in this type of application) or a lock nut (nylon or metal) is used.

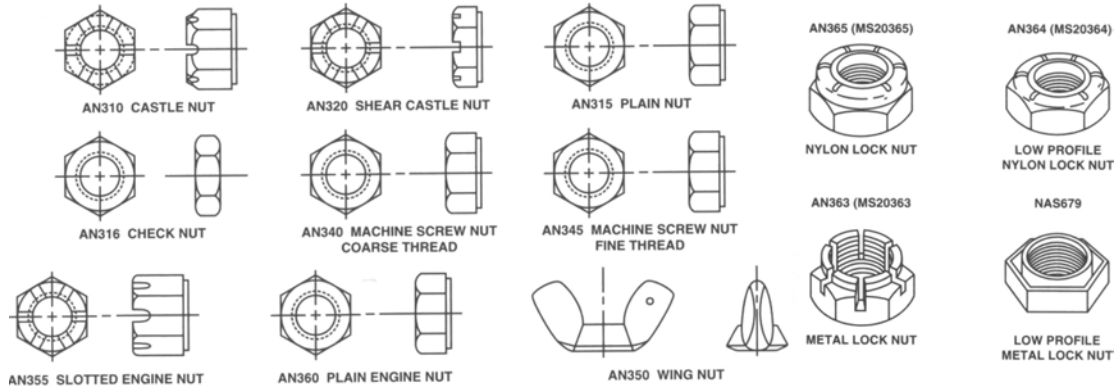

Figure B-2 Standard Aircraft Nuts

Note. From *A&P Technician General Textbook* (p. 8-21), by Jeppesen Standard Training Products, 2000, Englewood, CO:Jeppesen Sanderson Training Systems.

Washers are used to ensure that the bolt fits properly, to prevent the nut and / or bolt head from damaging the parts, and in the case of lock washers, to help prevent the nut from coming loose.

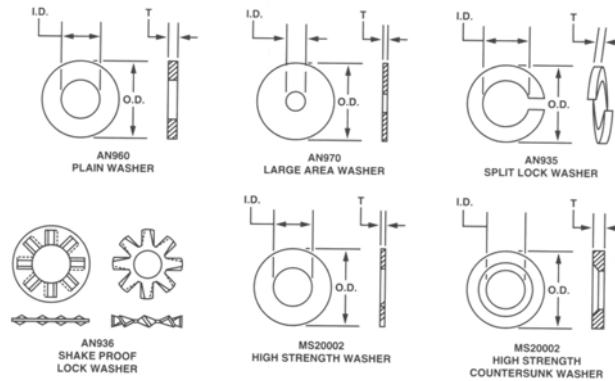

Figure B-3 Aircraft Washers

Note. From *A&P Technician General Textbook* (p. 8-30), by Jeppesen Standard Training Products, 2000, Englewood, CO:Jeppesen Sanderson Training Systems.

RIVETS

Rivets are used to join metal parts together, especially sheet metal parts (eg, attaching the metal skin of the wing to the metal ribs in the wing). When installed properly, rivets create a joint at least as strong as the material being joined.

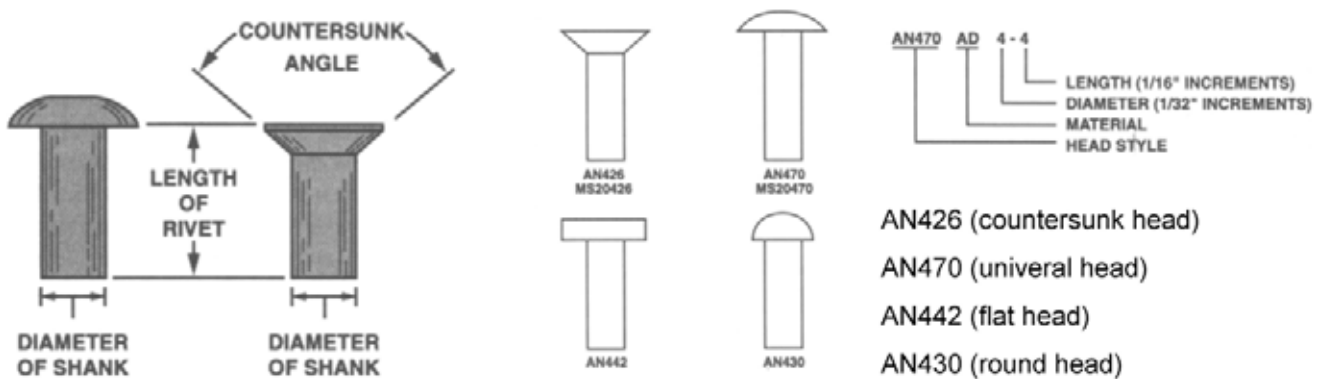

Figure C-1 Dimensions and AN Designations

Note. From *A&P Technician Airframe Textbook* (p. 2-36), by Jeppesen Standard Training Products, 2000, Englewood, CO: Jeppesen Sanderson Training Systems.

The general process for installing a rivet is to drill a hole slightly larger than the initial diameter of the rivet in the two pieces being joined. The rivet is inserted into the hole, and both ends of the rivet are carefully pressed together using special tools (a rivet gun on the head, and a bucking bar on the opposite end). The shank of the rivet swells to fill the hole, and the end of the rivet flattens out.

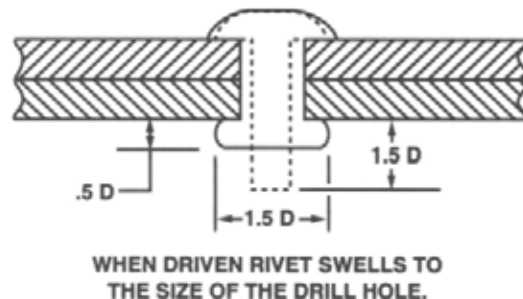

Figure C-2 Before and After Driving a Rivet

Note. From *A&P Technician Airframe Textbook* (p. 2-36), by Jeppesen Standard Training Products, 2000, Englewood, CO: Jeppesen Sanderson Training Systems.

Special Rivets

Standard rivets require access to both ends of the rivet to properly install it. Special rivets that only require access to one end have been developed for use in areas of the aircraft where it is not possible to access both ends of the rivet. These special rivets are also known as blind rivets and come in a variety of styles, usually identified by a brand name (eg, Huck-Lok, CherryLOCK, CherryMAX, Olympic-Lok).

Pop Rivets

Pop rivets are a type of special rivet (blind rivet). Although very common in non-aviation applications, pop rivets have limited uses in aviation. They are never used for structural applications, except as a temporary way to line up parts while installing permanent rivets.

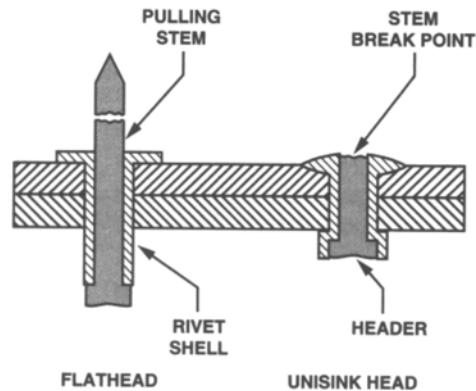

Figure C-3 Pop Rivets

Note. From *A&P Technician Airframe Textbook* (p. 2-40), by Jeppesen Standard Training Products, 2000, Englewood, CO:Jeppesen Sanderson Training Systems.

Cleco Fasteners

Prior to installing rivets, the parts need to be properly aligned and held in place. The most common method for doing this is by clamping the parts together. One of the most common clamping devices used in aviation is the Cleco fastener. A Cleco fastener is basically just a removable rivet.



Figure C-4 Cleco Pliers and Cleco Fasteners

Note. From "Cleco Pliers, Cleco Tool for Cleco Fasteners", *William Lees Sons Ltd.* Retrieved March 24, 2009, from <http://www.skinpins.com/toolsC200pliers.html>

A Cleco fastener is inserted into a hole (that will eventually hold a rivet) using a special pair of pliers and clamps the metal pieces together. Once the pieces are properly aligned (usually with a Cleco fastener in each rivet hole) the Cleco fasteners are removed one at a time and replaced by the permanent rivet.

Cleco fasteners come in different sizes that correspond to common rivet sizes. Each size is colour coded for easy identification.

Rivet / Cleco Diameter	Rivet Diameter Dash Number	Colour
3/32 inch	-3	Silver
1/8 inch	-4	Copper
5/32 inch	-5	Black
3/16 inch	-6	Brass
1/4 inch	-8	Copper

Figure C-5 Cleco Fastener Diameters and Colours

Note. From *A&P Technician Airframe Textbook* (p. 2-34), by Jeppesen Standard Training Products, 2000, Englewood, CO: Jeppesen Sanderson Training Systems.

THIS PAGE INTENTIONALLY LEFT BLANK

SCREWS

Screws are a very common threaded fastener in aviation and there are three basic classifications: machine screws, structural screws, and self-tapping screws. Screws generally have a loose fitting thread (eg, Class 2) and may have either a clearly defined grip length that is partially threaded or be threaded along their entire length. While most screws have heads designed to accept a screwdriver, some have heads that require a wrench.

Machine Screws

Machine screws are generally used for attaching fairings, inspection plates, fluid line clamps, and other light structural parts. Machine screws are usually threaded along their entire length and are available with national coarse or national fine threads. These screws may be made of several different types of materials and may be coated or treated in various ways.

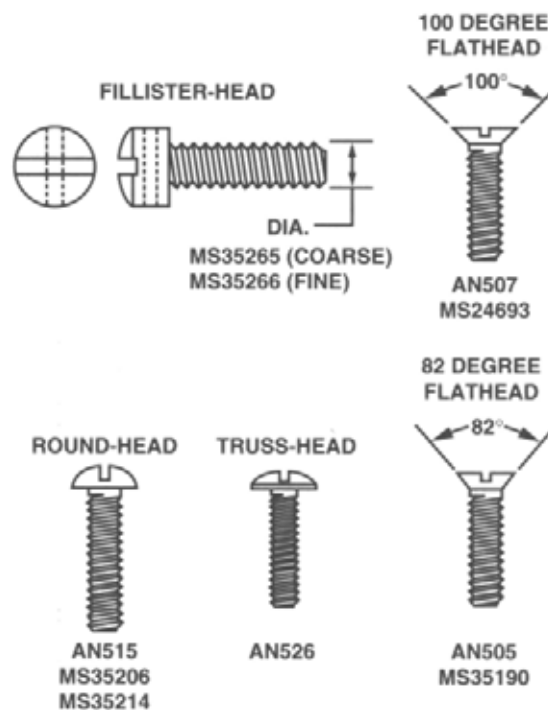

Figure D-1 Machine Screws

Note. From *A&P Technician General Textbook* (p. 8-27), by Jeppesen Standard Training Products, 2000, Englewood, CO:Jeppesen Sanderson Training Systems.

Structural Screws

Structural screws are very similar to standard bolts. They are heat treated and have the same shear strength as a bolt of the same size. Shank tolerances are similar to bolts and the threads are national fine.

Self-Tapping Screws

Self-tapping screws are used to hold thin sheets of metal, plastic, or plywood together. They have a coarse thread and come with a sharp (Type A) or blunt (Type B) point.

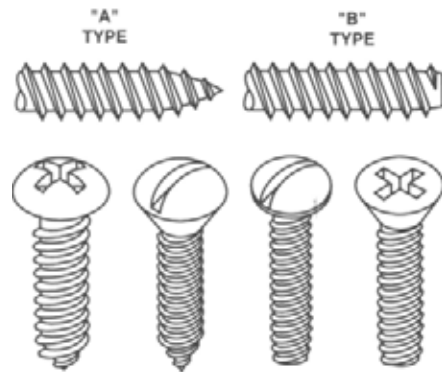

Figure D-2 Self-Tapping Sheet Metal Screws

Note. From *A&P Technician General Textbook* (p. 8-28), by Jeppesen Standard Training Products, 2000, Englewood, CO:Jeppesen Sanderson Training Systems.

TURNLOCK FASTENERS

Turnlock fasteners are used when quick and easy removal or opening of access panels, doors, and cowlings is required. There are three common types, each identified by their trade or brand name: Dzus, Airloc, and Camlock.

Dzus Fastener

Dzus (pronounced Zeus) fasteners are commonly found on cowling and inspection panels that must be frequently opened. The stud is mounted on the cowling or panel, and fits into the receptacle when the parts are aligned (closed). A quarter turn of the stud opens or closes the fastener. When closed, the stud grips a spring in the receptacle which keeps it closed.

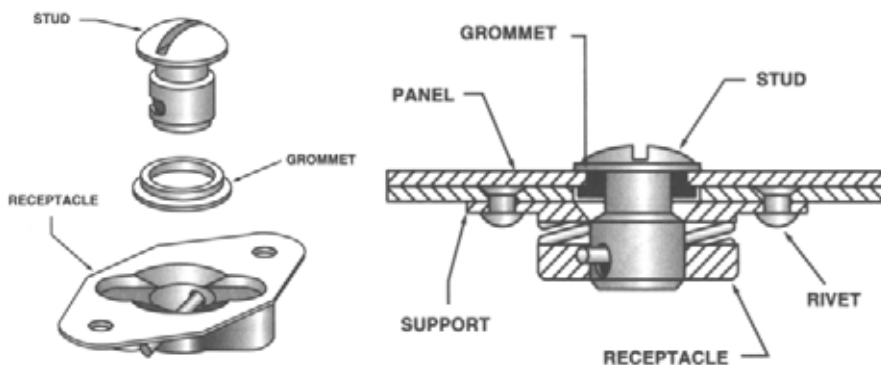

Figure E-1 Dzus® Fastener

Note. From *A&P Technician Airframe Textbook* (p. 2-49), by Jeppesen Standard Training Products, 2000, Englewood, CO:Jeppesen Sanderson Training Systems.

Airloc Fasteners

Airloc fasteners use a stud that has a pin, as opposed to Dzus fasteners that have a notch in the pin. When turned, the pin engages the spring in the receptacle. These fasteners are used in the same applications as Dzus fasteners.

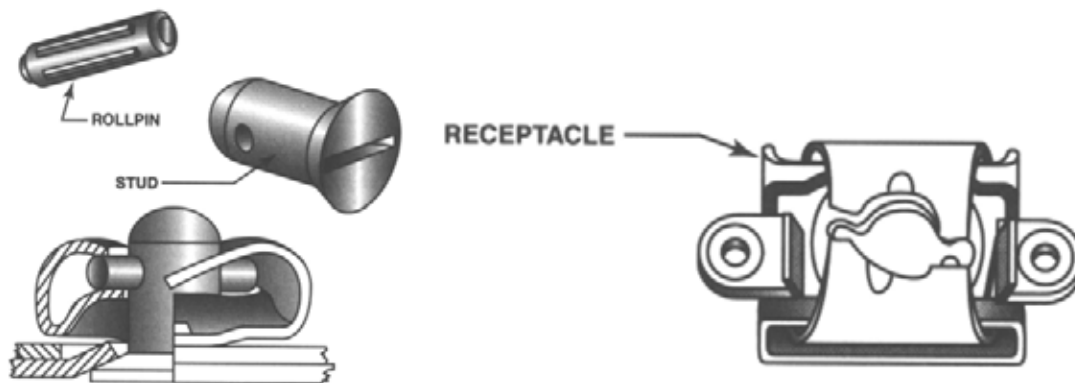

Figure E-2 Airloc® Cowling Fastener

Note. From *A&P Technician Airframe Textbook* (p. 2-50), by Jeppesen Standard Training Products, 2000, Englewood, CO:Jeppesen Sanderson Training Systems.

Camlock Fasteners

Camlock fasteners have a stud assembly that includes a spring and a pin. When the stud is pressed into the receptacle, the spring compresses and allows the pin to be rotated into position in the receptacle. When the stud is released, the spring expands, and holds the pin in place in a groove in the bottom of the receptacle.

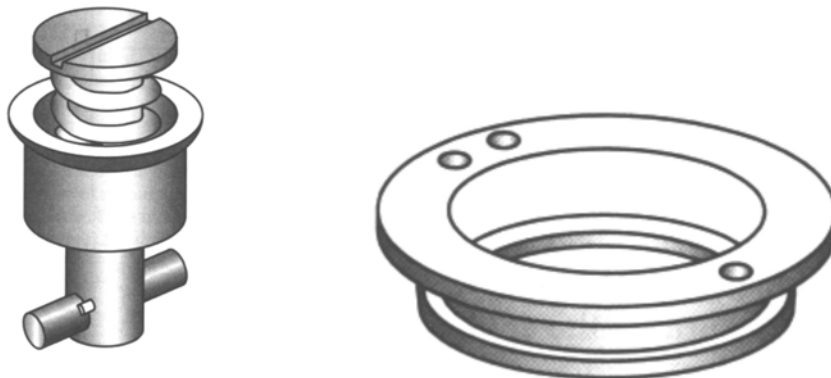

Figure E-3 Camlock® Cowling Fastener

Note. From *A&P Technician Airframe Textbook* (p. 2-50), by Jeppesen Standard Training Products, 2000, Englewood, CO:Jeppesen Sanderson Training Systems.

Aviation Hardware Identification Worksheet

Aviation Hardware

What two specification and standard identification systems are the most common?

_____, and
_____.

Bolts

Identify the aviation hardware shown below:

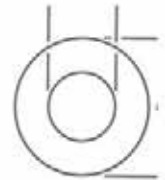

An AN7-12 bolt:

- has a length of _____ inch(es),
- has a diameter of _____ inch(es),
- is made of _____, and
- _____ a hole drilled in the head for lock wire.

An AN3-13A bolt:

- has a length of _____ inch(es),
- has a diameter of _____ inch(es),
- is made of _____, and
- _____ a hole drilled in the threads for a cotter pin.

Rivets

Identify the aviation hardware shown below:



An AN442AD4-4 rivet:

- has a length of _____ inch(es),
- has a diameter of _____ inch(es), and
- has a _____ head.

Pop rivets _____ used for structural applications.

_____ are used when there is not easy access to both ends of the rivet.

Screws

Identify the aviation hardware shown below:



Most screws are installed using a _____. Some screws may require a _____ to install them.

Turnlock Fasteners

Identify the aviation hardware shown below:

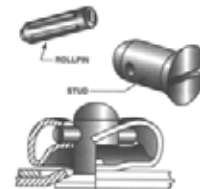
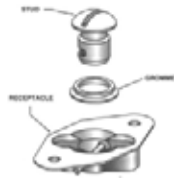
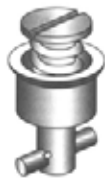

Most turnlock fasteners only need to be turned _____ to be opened or closed.

Aviation Hardware Identification Worksheet Answer Key

Aviation Hardware

What two specification and standard identification systems are the most common?

 AIR FORCE-NAVY (AN) , and
 MILITARY STANDARDS 20 (MS20) .

Bolts

Identify the aviation hardware shown below:



 AIRCRAFT BOLTS



 NYLON LOCK NUT



 PLAIN WASHER (AN690)

An AN7-12 bolt:

- has a length of 1-1/4 inch(es),
- has a diameter of 7/16 inch(es),
- is made of CADMIUM-PLATED NICKEL STEEL , and
- DOES NOT HAVE a hole drilled in the head for lock wire

An AN3-13A bolt:

- has a length of 1-3/8 inch(es),
- has a diameter of 3/16 inch(es),
- is made of CADMIUM-PLATED NICKEL STEEL , and
- DOES NOT HAVE a hole drilled in the threads for a cotter pin.

Rivets

Identify the aviation hardware shown below:



 ROUND HEAD RIVET
 (AN430)



 CLECO FASTENER

An AN442AD4-4 rivet:

- has a length of 1/4 inch(es),
- has a diameter of 1/8 inch(es), and
- has a FLAT head.

Pop rivets ARE NOT used for structural applications.

SPECIAL (BLIND) RIVETS are used when there is not easy access to both ends of the rivet.

Screws

Identify the aviation hardware shown below:

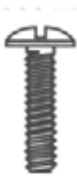

MACHINE SCREW



SELF-TAPPING SCREW

Most screws are installed using a SCREWDRIVER. Some screws may require a WRENCH to install them.

Turnlock Fasteners

Identify the aviation hardware shown below:



DZUS FASTENER

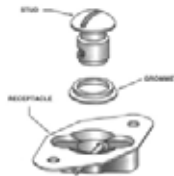

CAMLOCK FASTENER

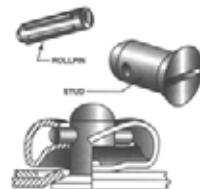

AIRLOC FASTENER

Most turnlock fasteners only need to be turned ONE QUARTER OF A TURN to be opened or closed.



ROYAL CANADIAN AIR CADETS
PROFICIENCY LEVEL FOUR
INSTRUCTIONAL GUIDE



SECTION 1

EO M490.01 – ASSEMBLE AN EMERGENCY SURVIVAL KIT

Total Time:	30 min
-------------	--------

PREPARATION

PRE-LESSON INSTRUCTIONS

Resources needed for the delivery of this lesson are listed in the lesson specification located in A-CR-CCP-804/PG-001, *Proficiency Level Four Standard and Plan*, Chapter 4. Specific uses for said resources are identified throughout the instructional guide within the TP for which they are required.

Review the lesson content and become familiar with the material prior to delivering the lesson.

Gather the emergency kit items needed for TP 3.

PRE-LESSON ASSIGNMENT

Nil.

APPROACH

An interactive lecture was chosen for TPs 1 and 2 to present basic material and give direction on assembling an emergency survival kit.

An in-class activity was chosen for TP 3 as it is an interactive way to provoke thought and stimulate interest among cadets about emergency survival kits.

INTRODUCTION

REVIEW

Nil.

OBJECTIVES

By the end of this lesson the cadets shall have assembled an emergency survival kit.

IMPORTANCE

It is important for cadets to be prepared for survival situations. Carrying an emergency survival kit at all times while in the field and knowing the purpose of the contents may help the cadets to react appropriately to survival situations.

Teaching Point 1**Discuss the characteristics of an emergency survival kit.**

Time: 5 min

Method: Interactive Lecture

ESSENTIAL ITEMS

The items carried in a personal emergency survival kit must meet the needs of a person in a survival situation. The essential items to fulfill these needs can be categorized.

Personal protection. This includes clothing, shelter, and fire.

Signalling. Constructed signals are ground-to-air signals and signal fires. An improvised signal may be a piece of shiny metal used as a signal mirror.

Sustenance. Water and food.

Travel. Navigating with and without a compass.

Health. This includes trauma and environmental injuries as well as mental health, which affects the will to survive.

SMALL AND EASY TO CARRY IN A POCKET

If the emergency survival kit is not with the person when it is needed, it is worthless. It needs to be carried at all times during outdoor activities.

It should be small enough to fit into a pocket, but not so bulky as to restrict movement.

It should be easy and comfortable to carry so that once placed in the pocket, it stays there until the outdoor activities are over or it is needed.

CONFIRMATION OF TEACHING POINT 1**QUESTIONS:**

- Q1. Name the five categories that should be considered when choosing essential items for an emergency survival kit.
- Q2. When should you carry an emergency survival kit?
- Q3. Where should an emergency survival kit be located?

ANTICIPATED ANSWERS:

- A1. Personal protection, signalling, sustenance, travel, and health.
- A2. At all times during outdoor activities.
- A3. It should be in your pocket.

Teaching Point 2**Explain that emergency survival kit items should be placed in a durable container that is lightweight and waterproof.**

Time: 5 min

Method: Interactive Lecture

The items in an emergency survival kit need to be readily available and in a useable condition, neither damaged by water nor compression (squished).

DURABLE

A container for an emergency survival kit must be durable to prevent compression, which can damage the items within.

LIGHTWEIGHT

The container should be lightweight. If it is too heavy, it becomes a burden to carry and therefore may be packed in the rucksack / backpack and not with the person when needed.

WATERPROOF

The container should be waterproof to protect items from water damage. Damaged items may be of no help in a survival situation.

Different types of containers have different characteristics which should be taken into account before deciding on which type a person will use. Types of containers include:

- **Hard plastic.** Very durable but may be uncomfortable to carry in a pocket.
- **Flexible plastic.** Durable, more comfortable than hard plastic in a pocket.
- **Metal.** Very durable but may be uncomfortable to carry in a pocket. However, unlike the plastic containers, a metal container may be used over a fire for multiple uses (eg, cooking, purifying water).

CONFIRMATION OF TEACHING POINT 2**QUESTIONS:**

- Q1. What three features should an emergency survival kit container have?
- Q2. What are the differences between containers made from hard and flexible plastic?
- Q3. What may be done with a metal container but not a plastic one?

ANTICIPATED ANSWERS:

- A1. It should be durable (to prevent compression), lightweight and waterproof (to protect items from water damage).
- A2. The hard plastic container is more durable, but the flexible plastic container will be more comfortable to carry in a pocket.
- A3. It may be used over a fire.

Teaching Point 5

Explain the purpose of each emergency survival kit item and have the cadets, as a group, assemble an emergency survival kit.

Time: 15 min

Method: In-Class Activity

BACKGROUND KNOWLEDGE**THE PURPOSE OF EACH EMERGENCY SURVIVAL KIT ITEM**

Adhesive bandages. Used for minor first aid.

Aluminum foil. May be used for cooking, water collection, and signalling.

Antibiotic tablets. Used to reduce the health risk of injuries.

Button compass. Used to determine direction.

Candle. May be used as a light source and a fire starter.

Condom. Used for water storage.

Cord. Used for lashings in multiple applications.

Cotton balls. May be used as tinder and to perform minor first aid.

Emergency blanket. Used to keep warm and may also be used for signalling.

Fish hooks. Used to catch fish.

Fishing line. Used to catch fish, but may also be used for lashings.

Fishing sinkers. Used to catch fish.

Flexible saw. Used to cut wood.

Garbage bag (small). This item has multiple uses: for raingear, as a water collector and for food storage.

Hard candies. Used as an energy food. It is also a morale booster.

Magnifying glass. Used to light fires and for first aid (to find small splinters).

Mirror (small). Used for signalling.

Moleskin. This item may be used as minor first aid for blisters.

Pain reliever (pills). Acetylsalicylic acid or acetaminophen, used as a pain reliever.

Paper. Used to write notes and may be used as tinder.

Pencil. Used to write notes.

Personal medication. Used to maintain health.

Re-sealable plastic bags (very small). Used to waterproof and organize small items within the kit.

Safety pins. These have multiple uses: to perform minor first aid and to repair clothing and equipment.

Salt. Used to maintain health.

Sewing needles. This item may be used for minor first aid and to repair clothing and equipment.

Small folding knife. Most versatile item in the survival kit.

Snare wire. Used to catch small animals and may also be used for lashings.

Thread. This item has multiple uses: used to create small lashings, for minor first aid and to repair clothing and equipment.

Tweezers. Used for minor first aid and to untie knots (so cord may be reused).

Water purification tablets. Used to purify water.

Waterproof matches. Used to light fires.

Whistle. Used to signal for help and to help scare off animals.

ACTIVITY

Time: 15 min

OBJECTIVE

The objective of this activity is to have the cadets assemble an emergency survival kit.

RESOURCES



This is not an exhaustive list and is designed to give cadets an idea of what an emergency survival kit could contain.

- hard or flexible plastic or metal container,
- adhesive bandages,
- aluminum foil,
- antibiotic tablets,
- button compass,
- candle,
- condom,
- cord,
- cotton balls,
- emergency blanket,
- fish hooks,
- fishing line,
- fishing sinkers,
- flexible saw,
- garbage bag (small),
- hard candies,
- magnifying glass,
- mirror (small),
- moleskin,
- pain reliever (pills),

- paper,
- pencil,
- personal medication,
- resealable plastic bags (very small),
- safety pins,
- salt,
- sewing needles,
- small folding knife,
- snare wire,
- thread,
- tweezers,
- water purification tablets,
- waterproof matches, and
- whistle.

ACTIVITY LAYOUT

Nil.

ACTIVITY INSTRUCTIONS

1. Show the cadets the hard or flexible plastic or metal container to be used for the emergency survival kit.
2. Ask the cadets what items should be in an emergency survival kit.
3. As each item is suggested, list it on the whiteboard / flip chart.
4. If the item suggested has been brought as an example, show it to the cadets.
5. Describe the purpose of the item.
6. Pass the item to a cadet.
7. Have the cadet place the item into the hard or flexible plastic or metal container to create an emergency survival kit.
8. Repeat Steps 3–7.



Ensure the items that are listed but not brought as examples are explained to the cadets.

SAFETY

Nil.

CONFIRMATION OF TEACHING POINT 3

The cadets' participation in the activity and the assembly of an emergency survival kit will serve as the confirmation of this TP.

END OF LESSON CONFIRMATION

The cadets' assembly of an emergency survival kit will serve as the confirmation of this lesson.

CONCLUSION

HOMEWORK / READING / PRACTICE

This EO is assessed IAW A-CR-CCP-804/PG-001, *Proficiency Level Four Standard and Plan*, Chapter 3, Annex B, 490 PC.

METHOD OF EVALUATION

Nil.

CLOSING STATEMENT

Being in possession of an emergency survival kit will greatly enhance your capabilities in a survival situation.

INSTRUCTOR NOTES / REMARKS

Cadets who are qualified Survival Instructor may assist with this instruction.

REFERENCES

C2-010 ISBN 0-375-70323-3 Rawlins, C., & Fletcher, C. (2004). *The complete walker IV*. New York, NY: Alfred A. Knopf.

C3-002 ISBN 0-00-653140-7 Wiseman, J. (1999). *SAS survival handbook*. Hammersmith, London: HarperCollins Publishers.

C3-003 ISBN 1-896713-00-9 Tawrell, P. (1996). *Camping and wilderness survival: The ultimate outdoors book*. Green Valley, ON: Author.

C3-150 ISBN 978-0-8117-3292-5 Davenport, G. (2002). *Wilderness survival*. Mechanicsburg, PA: Stackpole Books.

THIS PAGE INTENTIONALLY LEFT BLANK



ROYAL CANADIAN AIR CADETS
PROFICIENCY LEVEL FOUR
INSTRUCTIONAL GUIDE



SECTION 2

EO M490.02 – OPERATE A STOVE AND A LANTERN

Total Time:	90 min
-------------	--------

PREPARATION

PRE-LESSON INSTRUCTIONS

Resources needed for the delivery of this lesson are listed in the lesson specification located in A-CR-CCP-804/PG-001, *Proficiency Level Four Qualification Standard Plan*, Chapter 4. Specific uses for said resources are identified throughout the instructional guide within the TP for which they are required.

Review the lesson content and become familiar with the material prior to delivering the lesson.

The lesson has been designed using the common features of naphtha fuelled two-burner stoves and dual-mantle lanterns. Consult the operating manuals of the equipment to be used, and if necessary, modify the TPs accordingly.

PRE-LESSON ASSIGNMENT

Nil.

APPROACH

An interactive lecture was chosen for TPs 1 and 2 to introduce to the cadets the characteristics of the stove and of the lantern.

A demonstration and performance was chosen for TPs 3–6 as it allows the instructor to explain and demonstrate how to operate a stove and lantern while providing an opportunity for the cadets to practice the skill under supervision.

INTRODUCTION

REVIEW

Nil.

OBJECTIVES

By the end of this lesson the cadet shall have operated and a stove and a lantern.

IMPORTANCE

It is important for cadets to safely operate and maintain the stoves and lanterns most commonly used during field training. While on field training, a base of operations is required to support survival training.

Teaching Point 1

Identify the characteristics of a two-burner naphtha stove.

Time: 10 min

Method: Interactive Lecture

CHARACTERISTICS

The following are characteristics of a two-burner naphtha stove:

- It is capable of operating with a clean, smokeless flame.
- The flame can be quickly extinguished.
- It is easily ignited in cold weather.
- It is easy to refuel.
- It has no noxious odours.
- Fuel in the tank will not spill when being carried in any position.
- It cools quickly.
- It is easily cleaned and repaired.

Operational Temperature

A two-burner stove (that uses naphtha as a fuel), when shielded from the wind, can be used in temperatures as low as -52 Celsius.

Fuel Type

The stove uses naphtha. (Note: also known as white gas, camping fuel and Coleman fuel.)

Parts and Accessories



The following diagram is provided for part identification, not disassembly purposes.

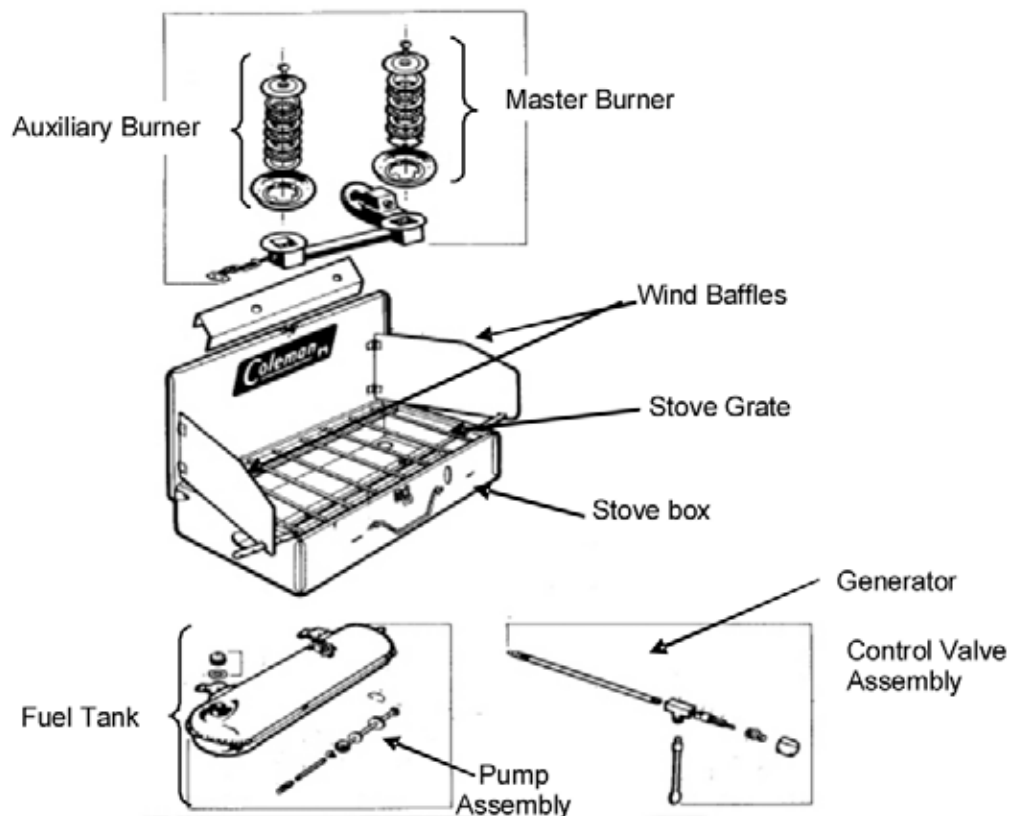

Figure 1 Parts of the Coleman Two-Burner Stove

Note. From Basic Cold Weather Training, Arctic and Sub Arctic Operations (Vol. 2) (p.2-75), 1982, Ottawa, ON: Department of National Defence. Copyright 1982 by Department of National Defence.

Stove box. This is the container in which the burners are mounted. The fuel tank and generator assembly are also stored here when the stove is disassembled for storage.

Control valve assembly. This consists of the main valve wheel, auxiliary value, nut and body. Its function is to regulate the flow of pressurized fuel from the fuel tank through the generator to the burner head. It remains attached to the fuel tank.

Master Burner. The master burner head is located on the right (or left, depending on make / model) of the stove and consists of a burner cap and a small screw with a series of burner rings. The entire assembly sits in a large burner bowl. The master burner control knob is located on the valve and generator assembly.

Auxiliary burner. The auxiliary burner head is located on the left (or right, depending on make / model) of the stove and consists of a burner cap and small screw along with a series of small burner rings. The entire assembly sits in a small burner bowl. The auxiliary burner control valve is located on the left (right) side of the stove box.

Pump assembly. The pump assembly is fitted into the tank and is held in place by a pump cap clip.

Fuel tank. The fuel tank is red in colour. The tank fits on the front of the stove box when in use.

Wind baffles. The wind baffles shelter the burners from the wind.

Stove grate. The stove grate supports cookware.

Generator. The generator supplies fuel to the burners. Fuel passing through the generator is heated by the master burner.

Precautions

Hazards are few if precautions are taken. Follow these simple rules:

- Never leave a lit stove unattended.
- Do not use a stove as a heating device or in an enclosed space.
- Never remove the fuel tank or loosen the filler cap on the fuel tank while the stove is in operation.
- Always fill and light the stove outside in a well ventilated area, away from open flame, heat and combustibles.
- Use only naphtha fuel.
- Store away from open flame or excessive heat.
- Always ensure wind baffles and lid supports are securely positioned before lighting the stove.
- Before transporting or storing, ensure the stove is cool. Loosen the filler cap to release the air pressure and retighten. Turn the control knob off. Ensure pump valve is closed.
- If the stove catches fire, turn off the fuel supply, close the wind baffles and drop the stove lid.
- When removing the fuel tank to be refilled, remember that the generator gets HOT when the stove is operated. Allow the generator to cool before refilling the fuel tank.
- When using the stove ensure that a fire extinguisher is readily available.



It is important to stress to cadets that stoves and lanterns should not be used in enclosed spaces such as buildings and tents unless they are well ventilated. The burning of naphtha results in the release of carbon monoxide. Carbon monoxide is heavier than air, it therefore pools in the bottoms of buildings and tents, where cadets usually sleep. It will not dissipate, even for days, unless it is forced out by a strong, persistent, direct draft of cold air at floor / ground level. Carbon monoxide can kill.

CONFIRMATION OF TEACHING POINT 1

QUESTIONS:

- Q1. What type of fuel is used?
- Q2. What is the purpose of the generator?
- Q3. Why should you only operate a stove in a well ventilated place?

ANTICIPATED ANSWERS:

- A1. Naphtha. (Note: also known as white gas, camping fuel and Coleman fuel.)
- A2. The generator supplies fuel to the burners. Fuel passing through the generator is heated by the master burner.

- A3. The burning of naphtha results in the release of carbon monoxide. Carbon monoxide is heavier than air, it therefore pools in the bottoms of buildings and tents, where cadets usually sleep. It will not dissipate, even for days, unless it is forced out by a strong, persistent, direct draft of cold air at floor / ground level. Carbon monoxide can kill.

Teaching Point 2

Identify the characteristics of a dual-mantle naphtha lantern.

Time: 5 min

Method: Interactive Lecture

CHARACTERISTICS

Dual-mantle lanterns are designed to burn naphtha. This fuel is pressurized in a tank attached to the unit, heated in a generator and then burned as a gas.



A lit lantern produces heat. Flammable materials should be kept a minimum of 60 cm above and 30 cm from all sides of the lantern.

Parts and Accessories

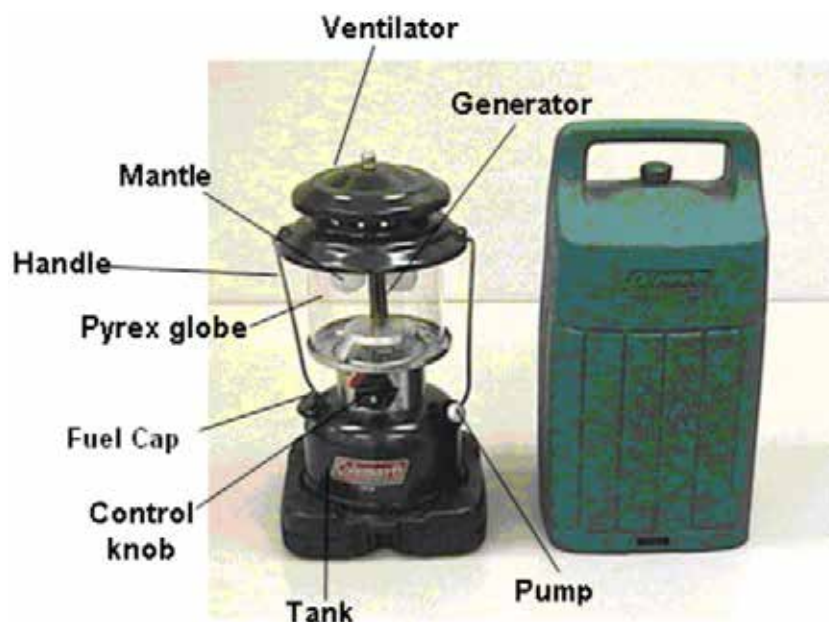

Figure 2 Coleman Dual-Mantle Lantern

Note. Created by Director Cadets 3, 2007, Ottawa, ON: Department of National Defence.

Ventilator. Allows for heat and exhaust to evacuate the lantern.

Generator. Provides pressurized fuel to the mantle.

Mantle. Emits a bright light by the burning naphtha fuel.

Handle. Allows the user to carry or hang the lantern.

Pyrex globe. Protects the mantle from foreign debris. The globe also reduces the amount of oxygen entering the lantern.

Fuel cap. Seals the fuel tank.

Control knob. Controls the amount of fuel entering the generator, controlling the brightness of the lantern.

Tank. Is a fuel storage reservoir.

Pump. Pumps air into the fuel tank, pressurizing the tank.

Precautions

Hazards are few when precautions are taken. The following simple rules should be used:

- Never leave a lit lantern unattended.
- Do not use a lantern as a heating device or in an enclosed space.
- Never loosen the filler cap on the fuel tank while the lantern is in operation.
- Always fill and light the lantern outside in a well ventilated area, away from open flame, heat and combustibles.
- Use only naphtha fuel.
- Store away from open flame or excessive heat.
- If the lantern catches fire, turn off the fuel supply and let the excess fuel burn off.
- When using the lantern ensure that a fire extinguisher is readily available.
- The ventilator is HOT when lantern is lit.
- If hung by the handle while the lantern is lit, the handle is HOT.
- Mantles should be regularly checked for holes (replace if found).

CONFIRMATION OF TEACHING POINT 2

QUESTIONS:

- Q1. What does the mantle do?
- Q2. What does the pump on the lantern do?
- Q3. When a lit lantern is hung, what should you keep in mind about the handle?

ANTICIPATED ANSWERS:

- A1. It emits a bright light by the burning naphtha fuel.
- A2. It pumps air into the fuel tank, pressurizing the tank.
- A3. If hung by the handle while the lantern is lit, the handle is HOT.

Teaching Point 3**Explain, demonstrate and have the cadets fill and drain a stove and a lantern, utilizing a drip pan.**

Time: 15 min

Method: Demonstration and Performance



For this skill, it is recommended that instruction take the following format:

1. Explain and demonstrate the complete skill while cadets observe.
2. Explain and demonstrate each step required to complete the skill. Monitor cadets as they imitate each step.
3. Monitor the cadets' performance as they practice the complete skill.

Note: Assistant instructors may be employed to monitor the cadets' performance.



Stoves and lanterns must be cool to the touch before filling or draining.

Filling a Stove

The steps to fill a two-burner stove tank are as follows:

1. Ensure main valve wheel is closed.
2. Close pump knob firmly.
3. Remove fuel cap.
4. Insert funnel.
5. Ensure fuel tank is level.
6. Fill with clean, fresh fuel until the level reaches the bottom of the fill hole.
7. Remove funnel, ensuring any spills / overflow fall into the drip pan.
8. Replace fuel cap.

Filling a Lantern

The steps to fill a dual-mantle lantern are as follows:

1. Ensure control valve is closed.
2. Close pump knob firmly.
3. Remove fuel cap.
4. Insert funnel.
5. Ensure lantern is level.
6. Fill with clean, fresh fuel until the level reaches the bottom of the fill hole.

7. Remove funnel, ensuring any spills / overflow fall into the drip pan.
8. Replace fuel cap.

Draining a Stove

The steps to drain a two-burner stove tank are as follows:

1. Ensure main valve wheel is closed.
2. Close pump knob firmly.
3. Remove fuel cap.
4. Insert funnel into fuel storage container.
5. Slowly and carefully pour fuel from tank into the funnel, ensuring any spills / overflow fall into the drip pan.
6. Replace fuel cap.

Draining a Lantern

The steps to drain a dual-mantle lantern are as follows:

1. Ensure control valve is closed.
2. Close pump knob firmly.
3. Remove fuel cap.
4. Insert funnel into fuel storage container.
5. Slowly and carefully pour fuel from lantern into the funnel, ensuring any spills / overflow fall into the drip pan.
6. Replace fuel cap.

CONFIRMATION OF TEACHING POINT 3

The cadets' participation in filling and draining a stove and a lantern will serve as the confirmation of this TP.

Teaching Point 4

Explain, demonstrate and have the cadets operate a two-burner naphtha stove.

Time: 15 min

Method: Demonstration and Performance

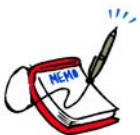

For this skill, it is recommended that instruction take the following format:

1. Explain and demonstrate the complete skill while cadets observe.
2. Explain and demonstrate each step required to complete the skill. Monitor cadets as they imitate each step.
3. Monitor the cadets' performance as they practice the complete skill.

Note: Assistant instructors may be employed to monitor the cadets' performance.

ASSEMBLING

To assemble a two-burner stove:

1. Unlatch and open the stove (as per Figure 3).
2. Open and secure the wind baffles (as per Figure 4).
3. Lift the grate and remove the fuel tank (as per Figure 5).
4. Install the fuel tank. Ensure the generator passes through the large hole in the front of the stove and is inserted into the opening in the mixing chamber above the burner. Insert hanger brackets on the tank into the slots located on the front of the stove case (as per Figure 5).
5. Secure the safety chain (as per Figure 6).
6. Close the grate (as per Figure 7).
7. Ensure the auxiliary burner valve is in the closed position (as per Figure 8).



Figure 3 Closed Stove

Note. Created by Director Cadets 3, 2007, Ottawa, ON: Department of National Defence.



Figure 4 Wind Baffles

Note. Created by Director Cadets 3, 2007, Ottawa, ON: Department of National Defence.



Figure 5 Installing the Fuel Tank

Note. Created by Director Cadets 3, 2007, Ottawa, ON: Department of National Defence.



Figure 6 Securing the Safety Chain

Note. Created by Director Cadets 3, 2007, Ottawa, ON: Department of National Defence.



Figure 7 Closed Gate

Note. Created by Director Cadets 3, 2007, Ottawa, ON: Department of National Defence.



Figure 8 Auxiliary Burner Control

Note. Created by Director Cadets 3, 2007, Ottawa, ON: Department of National Defence.

LIGHTING AND EXTINGUISHING



The stove fuel tank should have been fuelled previous to this lesson; however, it should not be pressurized.

Pressurizing the Fuel Tank

1. Make sure the control knob is in the OFF position.
2. Turn the pump rod two full turns counter-clock wise (as per Figure 9).
3. Place the thumb over the air vent of the pump rod handle (as per Figure 9).
4. Pump 30–40 full strokes to pressurize the fuel tank.
5. Turn the pump rod clockwise until it is closed tight (as per Figure 9).

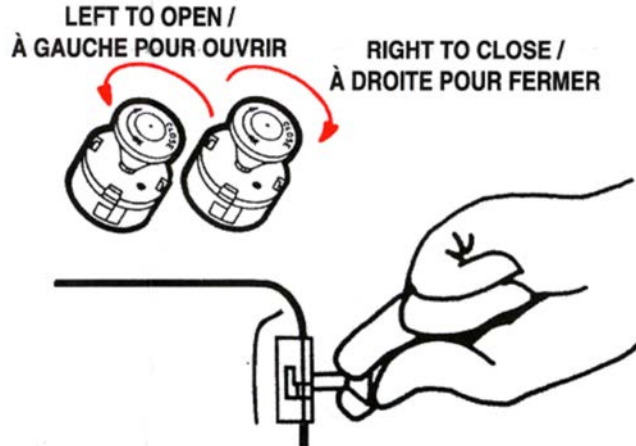

Figure 9 Pressurizing the Fuel Tank

Note. From *Coleman Camp Stove Model M425F710C Instructions for use*, by The Canadian Coleman Co., Mississauga, ON: The Coleman Company, Inc.

Lighting the Master Burner



During colder conditions, it may be necessary to warm the generator prior to lighting. This can be accomplished by applying a small amount of fuel to the master burner directly and lighting it with a match. The burning fuel will heat the generator, heating the fuel inside and facilitating the lighting of the burner. When the generator is not adequately heated it is possible for liquid fuel to pool in the stove which is very dangerous.

1. Ensure the auxiliary valve is in the closed position and the tank is pumped.
2. Do not lean over the stove while lighting.
3. Hold a lit match near the master burner (as per Figure 10).
4. Turn the instant light lever to the UP TO LIGHT position (as per Figure 10).
5. Turn the main valve control knob to the LIGHT position or setting.
6. Monitor the flame.
7. When the flame turns blue in colour (approximately one minute), turn the instant light lever to the DOWN TO BURN position and turn the control knob to the desired heat setting (HI – LO).

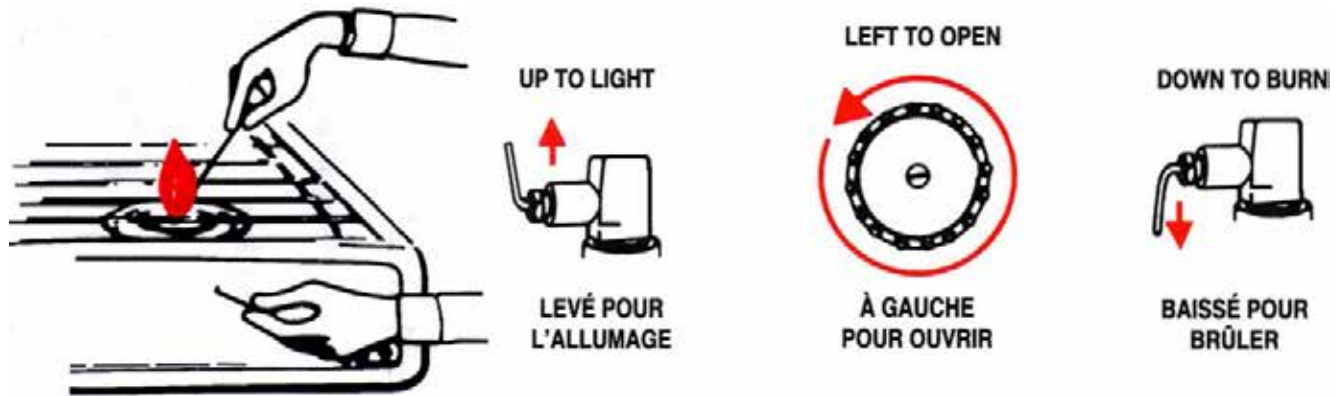

Figure 10 Lighting the Master Burner

Note. From *Coleman Camp Stove Model M425F710C Instructions for use*, by The Canadian Coleman Co., Mississauga, ON: The Coleman Company, Inc.



Should the stove fail to light or the match goes out before ignition, turn the control knob to the OFF position and wait two minutes before attempting to light the stove again.

Lighting the Auxiliary Burner

1. After the master burner has been lit, the auxiliary burner may be lit.
2. Hold a match to the auxiliary burner. Open the auxiliary valve located on the side of the stove box, next to the burner (the master burner may require adjustment after lighting the auxiliary burner).

Extinguishing the Burner

1. Close the auxiliary burner valve.
2. Remove cookware from the stove and turn the instant light lever up to LIGHT position and let burn for one minute. This cleans heavier parts of fuel from the generator.
3. Turn the main valve control knob clockwise to the OFF position and close firmly.



A small flame on the master burner will continue to burn for a few minutes, until the fuel empties from the generator.

DISASSEMBLING AFTER USE

To store a two-burner stove:

1. Allow the stove to cool before packing.
2. Ensure the stove is clean and any dirt, matches, etc. are emptied from the stove box.
3. Ensure the auxiliary burner valve is in the closed position.
4. Open the grate.
5. Remove the safety chain.

6. Uninstall the fuel tank and remove it from the stove box.
7. Unpressurize the fuel tank by loosening the filler cap, then retighten it to reseal the fuel tank. Note: Angle the fuel tank so that the filler cap is highest to reduce possible fuel leakage.
8. Place the fuel tank inside the stove box.
9. Close the grate.
10. Close and fold in the wind baffles.
11. Close the cover and latch the box.

CONFIRMATION OF TEACHING POINT 4

The cadets' participation in operating a stove will serve as the confirmation of this TP.

Teaching Point 5

Explain, demonstrate and have the cadets operate a dual-mantle naphtha lantern.

Time: 20 min

Method: Demonstration and Performance



For this skill, it is recommended that instruction take the following format:

1. Explain and demonstrate the complete skill while cadets observe.
2. Explain and demonstrate each step required to complete the skill. Monitor cadets as they imitate each step.
3. Monitor the cadets' performance as they practice the complete skill.

Note: Assistant instructors may be employed to monitor the cadets' performance.

ASSEMBLING

The lantern does not require assembly or disassembly except when replacing the mantles / globe. Before operating the lantern, the cadet should verify that the handle is in place and that the ball nut (screw on top of the ventilator) is tight.

LIGHTING AND EXTINGUISHING



The lantern should have been fuelled previous to this lesson; however, the lantern should not be pressurized. When a mantle is replaced it should be burned prior to use. By burning the mantle, the mantle shrinks down in size ensuring that combustion of the fuel takes place at the mantle. When the mantle is not burned prior to use fuel can leak out of the mantle prior to combustion.

Pressurizing the Fuel Tank

1. Make sure the control knob is in the OFF position.
2. Turn the pump rod two full turns counter-clockwise.
3. Place the thumb over the air vent of the pump rod handle.

4. Pump 30–40 full strokes to pressurize the fuel tank.
5. Turn the pump rod to clockwise until it is closed tight.

Lighting the Lantern



Do not position the hands or head above the lantern when lighting.

Mantles are very fragile and shall be avoided when using a match to light the lantern.

1. Insert a lit match through the hole in the bottom of the burner frame.
2. Turn the control knob to the LIGHT position.
3. When the mantle burns bright white (after about one minute), turn the control knob to the ON position.
4. Add more air pressure to the tank. Air pressure may be added while the lantern is in operation. Good air pressure is important for maximum light output.

Extinguishing the Lantern

1. Turn the control knob to the OFF position.
2. Allow the remaining fuel to burn off.

STORING AFTER USE

To store a dual-mantle lantern:

1. Ensure the lantern is cool.
2. Wipe and clean away any dirt.
3. Drain the fuel into a fuel storage container (do not drain as the lantern is required for the other groups to use).
4. Place in a cool, dry location.

CONFIRMATION OF TEACHING POINT 5

The cadets' participation in operating a lantern will serve as the confirmation of this TP.

Teaching Point 6**Explain, demonstrate and have the cadets perform minor maintenance on a stove and lantern.**

Time: 15 min

Method: Demonstration and Performance

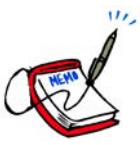

For this skill, it is recommended that instruction take the following format:

1. Explain and demonstrate the complete skill while cadets observe.
2. Explain and demonstrate each step required to complete the skill. Monitor cadets as they imitate each step.
3. Monitor the cadets' performance as they practice the complete skill.

Note: Assistant instructors may be employed to monitor the cadets' performance.

PERFORM MINOR MAINTENANCE

Stoves and lanterns must be cool to the touch before performing cleaning and any minor maintenance.

Cleaning the Stove

Clean as needed during a field exercise and before storage.

- Fuel tank should be wiped using fresh naphtha as the solvent.
- The burner assemblies should have the remains of matches and food residue (Note: Flame usually burns yellow instead of blue where there are remains and residue).
- Stove box should be washed with soap and water to remove food residue and grease.



The burner assemblies should not be immersed in water as any water left in the tubes will cut-off or restrict the flow of fuel. Burner assemblies should be removed from the stove box and cleaned separately if the stove box is being immersed to be cleaned.

Cleaning the Lantern

Clean as needed during a field exercise and before storage.

- Fuel tank and ventilator should be wiped using fresh naphtha as the solvent.
- Remains of matches should be removed from inside the globe.
- Globe should be carefully cleaned and dried.

Replacing a Mantle

If a mantle has fallen apart or has a hole in it, it should be replaced before operating the lantern.

1. Remove handle by pulling the handle arms gently away from the lantern.
2. Unscrew and remove the ball nut.

3. Remove the ventilator.
4. Remove the globe.
5. Only use the appropriate mantle for the lantern.
6. Remove the remains of the old mantle.
7. Tie mantle around the grooves in the burner cap, with the flat side of the mantle facing the generator (as per Figure 11).
8. Cut off excess string.
9. Light bottom of the mantle evenly, burning until nothing but ash is left.
10. Allow mantle to cool before lighting the lantern.
11. Reassemble the lantern.

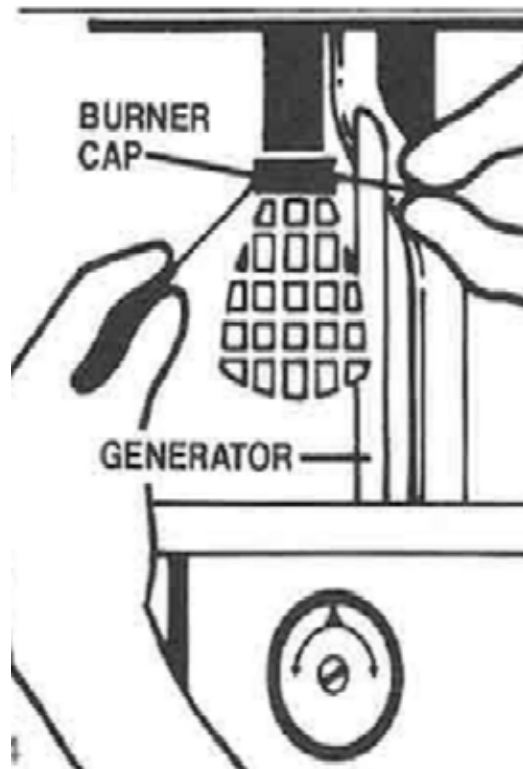

Figure 11 Replacing a Mantle

Note. From Coleman Lantern Model 220K195 & 228K195 How To Use and Enjoy, by The Canadian Coleman Co., Toronto, ON: The Coleman Company, Inc.

Inspecting the Pump Assembly

1. Remove clip from pump cap using needle-nose pliers (as per Figure 12).
2. Turn pump knob counter clockwise several times to unscrew air stem.
3. Pull out pump and air stem (as per Figure 12).
4. Examine pump leather, if dry, work several drops of oil into it.

5. Insert pump and air stem into tank (pump leather must not invert or fold).
6. Replace pump cap and clip.
7. Turn pump knob clockwise several times to screw air stem into the tank.

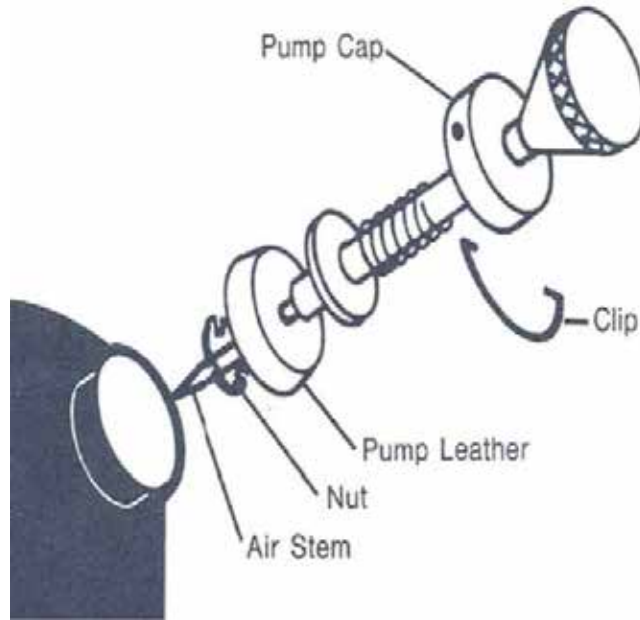

Figure 12 Pump Assembly

Note. From Coleman Lantern Model 220K195 & 228K195 How To Use and Enjoy, by The Canadian Coleman Co., Toronto, ON: The Coleman Company, Inc.

CONFIRMATION OF TEACHING POINT 6

The cadets' participation in performing minor maintenance will serve as the confirmation of this TP.

END OF LESSON CONFIRMATION

The cadets' filling and draining, operating and performing minor maintenance on a two-burner stove and a dual-mantle lantern will serve as confirmation of this lesson.

CONCLUSION

HOMEWORK / READING / PRACTICE

Nil.

METHOD OF EVALUATION

This EO is assessed IAW A-CR-CCP-804/PG-001, *Proficiency Level Four Standard and Plan*, Chapter 3, Annex B, 490 PC.

CLOSING STATEMENT

Knowing how to operate a stove and a lantern will give the cadets the skills needed to help support survival training during field exercises.

INSTRUCTOR NOTES / REMARKS

The spill response kit will be at the fuelling area.

Refer to the manuals for all operations and maintenance of the two-burner naphtha stove and dual-mantle naphtha lantern.

A fire extinguisher will be at each site where stoves and lanterns are being lit.

When cleaning the stove, the fuel tank is to be wiped with fresh naphtha. Protective gloves and clothing are to be worn when completing this task. Acceptable materials for gloves are neoprene, nitrile / viton. It is also recommended that safety glasses, splash goggles, or face shield be worn. Have eye water wash available.

Cadets who are qualified Survival Instructor may assist with this instruction.

REFERENCES

Manuals for stove and lantern types being used.

THIS PAGE INTENTIONALLY LEFT BLANK



ROYAL CANADIAN AIR CADETS
PROFICIENCY LEVEL FOUR
INSTRUCTIONAL GUIDE



SECTION 3

EO M490.03 – TIE KNOTS AND LASHINGS

Total Time:	60 min
-------------	--------

PREPARATION

PRE-LESSON INSTRUCTIONS

Resources needed for the delivery of this lesson are listed in the lesson specification located in A-CR-CCP-804/PG-001, *Proficiency Level Four Qualification Standard and Plan*, Chapter 4. Specific uses for said resources are identified throughout the instructional guide within the TP for which they are required.

Review the lesson content and become familiar with the material prior to delivering the lesson.

Photocopy the knot-tying and lashing instructions located at Attachments A and B for each cadet.

Cut lengths of braided rope for the cadets to tie the knots. The rope should be 10 mm (3/8 inch) in diameter and 3 m (10 feet) in length. Each cadet will require two lengths of rope.

Collect poles from natural resources. Poles should be approximately 2 m in length and 6 cm in diameter. Each cadet will require two poles.

PRE-LESSON ASSIGNMENT

Nil.

APPROACH

An interactive lecture was chosen for TP 1 to present background material on rope terminology.

A demonstration and performance was chosen for TPs 2 and 3 as it allows the instructor to explain and demonstrate tying knots and lashings while providing an opportunity for the cadets to practice and develop these skills under supervision.

INTRODUCTION

REVIEW

Nil.

OBJECTIVES

By the end of this lesson the cadet shall have tied knots and lashings.

IMPORTANCE

It is important for the cadets to know how to tie different knots and lashings in order to construct sturdy shelters, tents, snares and camp crafts.

Teaching Point 1

Time: 10 min

Describe the parts of a rope.

Method: Interactive Lecture

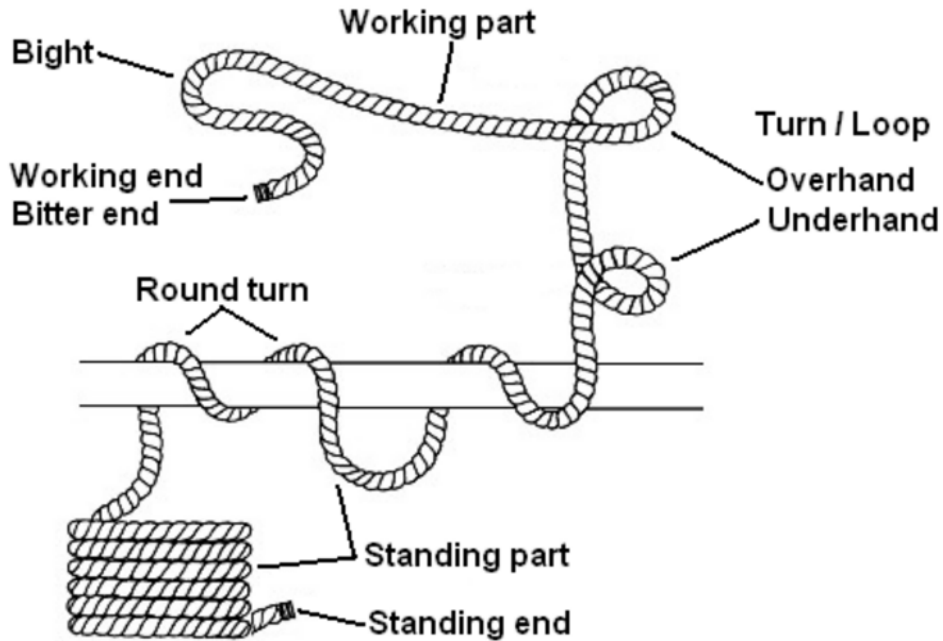

Figure 1 Parts of a Rope

Note. From *Lost Knowledge Site*, by B. Green. 2006. Retrieved March 6, 2009, from <http://lostknowledgesite.com/BackToBasics/Knots/Knots.html>

PARTS OF A ROPE

The following definitions will assist cadets when tying each knot or lashing:

Working end (Bitter end). The very end of the rope that is used for tying a knot.

Working part (Running part). is the short length of rope that is manipulated to make the knot.

Standing end. The end of the rope opposite the end being used for tying a knot.

Standing part. The section of rope that usually “stands still” during the knot-tying process. Often it is the longer end that leads away from the loop, bight or knot.

Turn or Loop. A part of rope that crosses over itself. The working part can be over or under the standing part in a crossing turn.

Bight. A loop in the rope that does not cross over itself.

CONFIRMATION OF TEACHING POINT 1**QUESTIONS:**

- Q1. What part of the rope is called the working part?
- Q2. What is a bight?
- Q3. What is the standing end?

ANTICIPATED ANSWERS:

- A1. The working part (running part) is the short length of rope that is manipulated to make the knot.
- A2. A bight is a loop in the rope that does not cross over itself.
- A3. The standing end is the end of the rope opposite the end being used for tying a knot.

Teaching Point 2**Explain, demonstrate and have the cadets tie knots.**

Time: 20 min

Method: Demonstration and Performance



For this skill lesson, it is recommended that the instructor take the following format:

1. Explain and demonstrate the complete knot while cadets observe.
2. Explain and demonstrate each step required to complete the knot. Monitor cadets as they imitate each step.
3. Monitor the cadets' performance as they practice the complete knot.

Note: Assistant instructors may be used to monitor the cadets' performance.

KNOTS

Reef knot. The reef knot is used for joining two ropes of equal diameter together. This knot can hold a moderate amount of weight and is ideal for first aid. It may be used when tying slings because the knot lies flat against the body.

Steps for Tying a Reef Knot

1. Place the left-hand working end on the top of the right-hand working end.



Figure 2 Step 1

Note. From *Pocket Guide to Knots and Splices* (p. 98), by D. Pawson, 2001, London, England: Prospero Books Inc. Copyright 2001 by PRC Publishing Ltd.

2. Bring the left-hand working end under the right-hand working end.



Figure 3 Step 2

Note. From *Pocket Guide to Knots and Splices* (p. 98), by D. Pawson, 2001, London, England: Prospero Books Inc. Copyright 2001 by PRC Publishing Ltd.

3. Place the working end that is now on the right, on top of the working end that is now on the left.

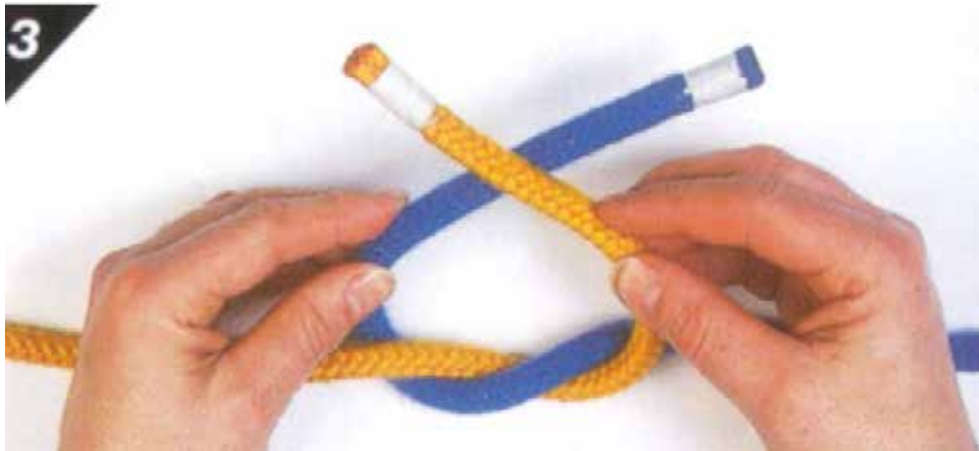

Figure 4 Step 3

Note. From *Pocket Guide to Knots and Splices* (p. 98), by D. Pawson, 2001, London, England: Prospero Books Inc. Copyright 2001 by PRC Publishing Ltd.

4. Bring the working end that is on top under the other working end so it comes out at the same place it entered the knot.



Figure 5 Step 4

Note. From *Pocket Guide to Knots and Splices* (p. 98), by D. Pawson, 2001, London, England: Prospero Books Inc. Copyright 2001 by PRC Publishing Ltd.

5. Pull tight to complete the reef knot.



Figure 6 Step 5

Note. From *Pocket Guide to Knots and Splices* (p. 98), by D. Pawson, 2001, London, England: Prospero Books Inc. Copyright 2001 by PRC Publishing Ltd.

Figure-of-eight knot. The figure-of-eight knot is very simple and quick to tie. It makes an ideal stopper knot and is very easy to untie.

Steps for Tying a Figure-of-Eight Knot

1. Make a crossing turn with the working end passing under the standing part of the rope and then bring the working end over the standing part.

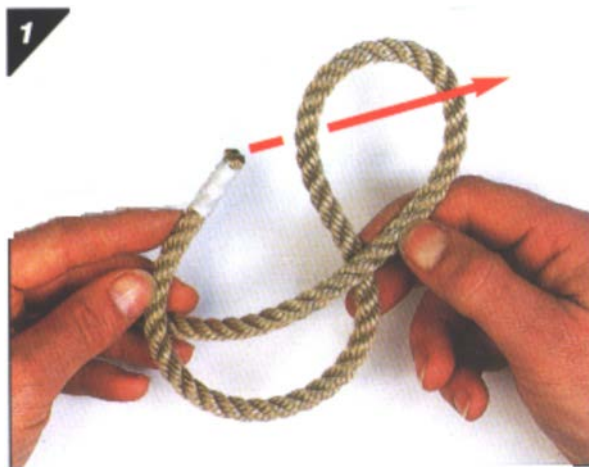

Figure 7 Step 1

Note. From *Pocket Guide to Knots and Splices* (p. 44), by D. Pawson, 2001, London, England: Prospero Books Inc. Copyright 2001 by PRC Publishing Ltd.

2. Now tuck the working end up through the loop from behind, forming a figure-of-eight.



Figure 8 Step 2

Note. From *Pocket Guide to Knots and Splices* (p. 44), by D. Pawson, 2001, London, England: Prospero Books Inc. Copyright 2001 by PRC Publishing Ltd.

3. Pull tight to complete the figure-of-eight knot.



Figure 9 Step 3

Note. From *Pocket Guide to Knots and Splices* (p. 44), by D. Pawson, 2001, London, England: Prospero Books Inc. Copyright 2001 by PRC Publishing Ltd.

Clove hitch. The clove hitch consists of two half hitches or crossing turns each made in the same direction. It is used to finish and start lashings and should not be used in a situation where the hitch has variable tension as it can work loose.

Steps for Tying a Clove Hitch

1. Make a turn around a pole / tree bringing the working end of the rope over and trapping the standing part of the rope. This makes the first half hitch.



Figure 10 Step 1

Note. From *Pocket Guide to Knots and Splices* (p. 106), by D. Pawson, 2001, London, England: Prospero Books Inc. Copyright 2001 by PRC Publishing Ltd.

2. Bring the working end behind the pole / tree, above the first half hitch.



Figure 11 Step 2

Note. From *Pocket Guide to Knots and Splices* (p. 106), by D. Pawson, 2001, London, England: Prospero Books Inc. Copyright 2001 by PRC Publishing Ltd.

- Put the working end under the turn just made. This gives the second half hitch and forms the clove hitch.



Figure 12 Step 3

Note. From *Pocket Guide to Knots and Splices* (p. 106), by D. Pawson, 2001, London, England: Prospero Books Inc. Copyright 2001 by PRC Publishing Ltd.

- Pull tight to complete the clove hitch.



Figure 13 Step 4

Note. From *Pocket Guide to Knots and Splices* (p. 106), by D. Pawson, 2001, London, England: Prospero Books Inc. Copyright 2001 by PRC Publishing Ltd.

Bowline. The bowline is a very secure knot that will not slip, regardless of the load applied. Use this knot whenever a non-slip loop is required at the end of a line.

Steps to Tying a Bowline

1. A short distance back from the working end, make a crossing turn with the working part on top. Go on to form the size of the loop you require.



Figure 14 Step 1

Note. From *Pocket Guide to Knots and Splices* (p. 163), by D. Pawson, 2001, London, England: Prospero Books Inc. Copyright 2001 by PRC Publishing Ltd.

2. Bring the working end up through the crossing turn. It will go under first, and then lie on top of the other part of the turn.



Figure 15 Step 2

Note. From *Pocket Guide to Knots and Splices* (p. 163), by D. Pawson, 2001, London, England: Prospero Books Inc. Copyright 2001 by PRC Publishing Ltd.

3. Bring the working end around behind the standing part and down through the crossing turn. A good way to remember this is: “the rabbit comes out of the hole, around the tree and back down the hole again”.

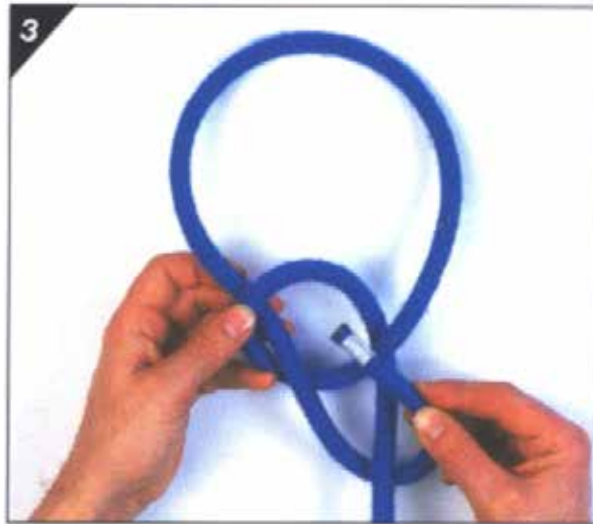

Figure 16 Step 3

Note. From *Pocket Guide to Knots and Splices* (p. 163), by D. Pawson, 2001, London, England: Prospero Books Inc. Copyright 2001 by PRC Publishing Ltd.

4. Pull tight by holding the working end and pulling on the standing part to complete the bowline.



Figure 17 Step 4

Note. From *Pocket Guide to Knots and Splices* (p. 163), by D. Pawson, 2001, London, England: Prospero Books Inc. Copyright 2001 by PRC Publishing Ltd.



Distribute Attachment A to the cadets, so they may practice the knots after the lesson.

CONFIRMATION OF TEACHING POINT 2

The cadets' participation in tying knots will serve as the confirmation of this TP.

Teaching Point 3**Explain, demonstrate and have the cadets tie lashings.**

Time: 20 min

Method: Demonstration and Performance



For this skill, it is recommended that the instruction take the following format:

1. Explain and demonstrate the complete lashing while cadets observe.
2. Explain and demonstrate each step required to complete the lashing. Monitor cadets as they imitate each step.
3. Monitor the cadets' performance as they practice the complete lashing.

Note: Assistant instructors may be used to monitor the cadets' performance.

LASHINGS

Round lashing. Sometimes called a sheer lashing, the round lashing has two distinct uses. First, it creates an "A" frame or set of using a single lashing. Second, two or three round lashings can be used to bind together a couple of poles to make a longer spar. To make an "A" frame, two poles are put side by side; the lashing is made at one end as illustrated in Figures 18–24. A slightly different approach is used to join two poles together to make a longer pole. The procedure is exactly the same, except the initial and final clove hitches are tied around both poles and there is no space left between the poles and no frapping is used. For extra strength to the spar, add extra lashings at the opposite end and middle of the adjoining poles.

Steps to Tying a Round Lashing

1. Start by making a clove hitch around both poles.



Figure 18 Step 1

Note. From *Pocket Guide to Knots and Splices* (p. 184), by D. Pawson, 2001, London, England: Prospero Books Inc. Copyright 2001 by PRC Publishing Ltd.

2. Wrap around both poles, trapping the end of the clove hitch.

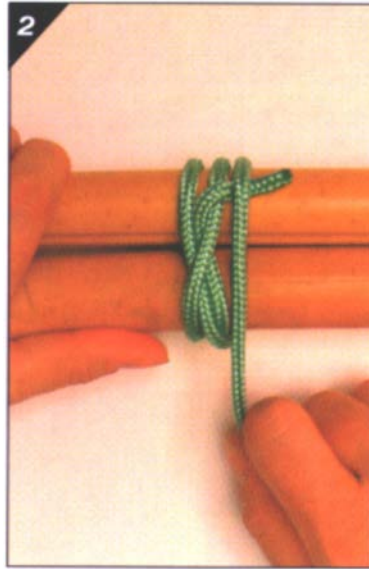

Figure 19 Step 2

Note. From *Pocket Guide to Knots and Splices* (p. 184), by D. Pawson, 2001, London, England: Prospero Books Inc. Copyright 2001 by PRC Publishing Ltd.

3. Carry on making eight to ten more turns round the pair of poles.



Figure 20 Step 3

Note. From *Pocket Guide to Knots and Splices* (p. 184), by D. Pawson, 2001, London, England: Prospero Books Inc. Copyright 2001 by PRC Publishing Ltd.

4. The lashing could now be finished with a clove hitch around both poles or put in a couple of frapping turns by bringing the end of the rope between the two poles.



Figure 21 Step 4

Note. From *Pocket Guide to Knots and Splices* (p. 185), by D. Pawson, 2001, London, England: Prospero Books Inc. Copyright 2001 by PRC Publishing Ltd.

5. Finish off with a clove hitch around one of the poles.



Figure 22 Step 5

Note. From *Pocket Guide to Knots and Splices* (p. 185), by D. Pawson, 2001, London, England: Prospero Books Inc. Copyright 2001 by PRC Publishing Ltd.

6. Pull tight to finish the round lashing with the poles parallel.

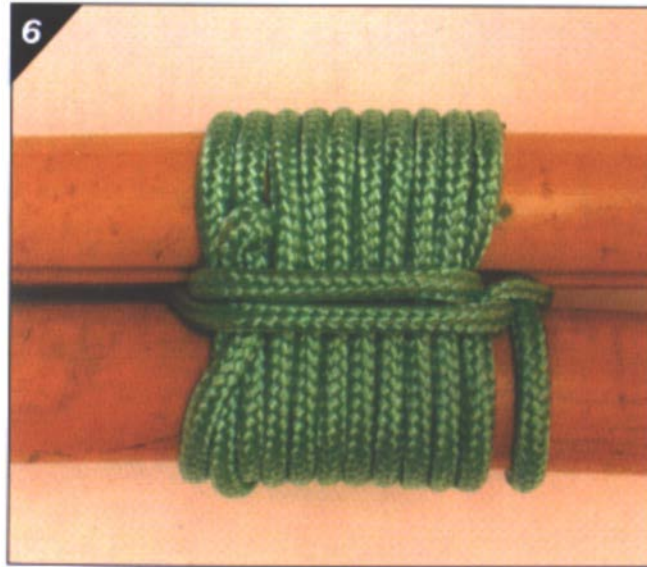

Figure 23 Step 6

Note. From *Pocket Guide to Knots and Splices* (p. 185), by D. Pawson, 2001, London, England: Prospero Books Inc. Copyright 2001 by PRC Publishing Ltd.

7. If being used for an "A" frame then open the poles.



Figure 24 Step 7

Note. From *Pocket Guide to Knots and Splices* (p. 185), by D. Pawson, 2001, London, England: Prospero Books Inc. Copyright 2001 by PRC Publishing Ltd.

Square lashing. A square lashing secures two poles together at 90 degrees and can be used in the construction of shelters and camp crafts. The cord used to make the lashing should be considerably smaller than the size of the poles. For the lashing to be effective, each turn must be pulled as tight as possible as it is made.

Steps to Tying a Square Lashing

1. With the vertical pole on top of the horizontal pole, make a clove hitch on the vertical pole just below the horizontal pole.



Figure 25 Step 1

Note. From *Pocket Guide to Knots and Splices* (p. 181), by D. Pawson, 2001, London, England: Prospero Books Inc. Copyright 2001 by PRC Publishing Ltd.

2. Bring all the cord around behind the horizontal pole.

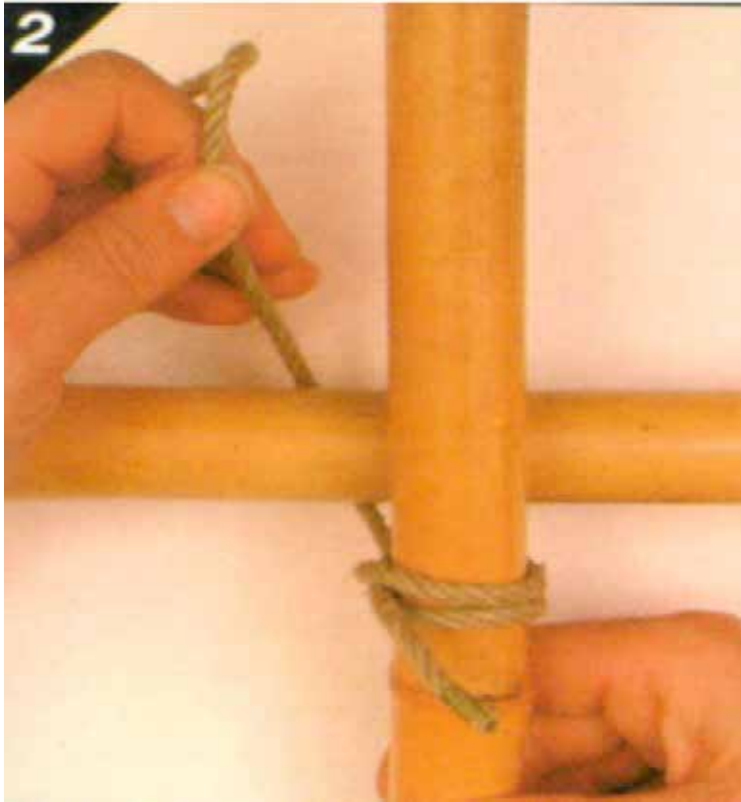

Figure 26 Step 2

Note. From *Pocket Guide to Knots and Splices* (p. 181), by D. Pawson, 2001, London, England: Prospero Books Inc. Copyright 2001 by PRC Publishing Ltd.

3. Bring the cord over the vertical pole and back behind the horizontal pole to the clove hitch. Pull tight.



Figure 27 Step 3

Note. From *Pocket Guide to Knots and Splices* (p. 181), by D. Pawson, 2001, London, England: Prospero Books Inc. Copyright 2001 by PRC Publishing Ltd.

4. Carry on making two or three more complete turns around the two poles, pulling tight after each turn.

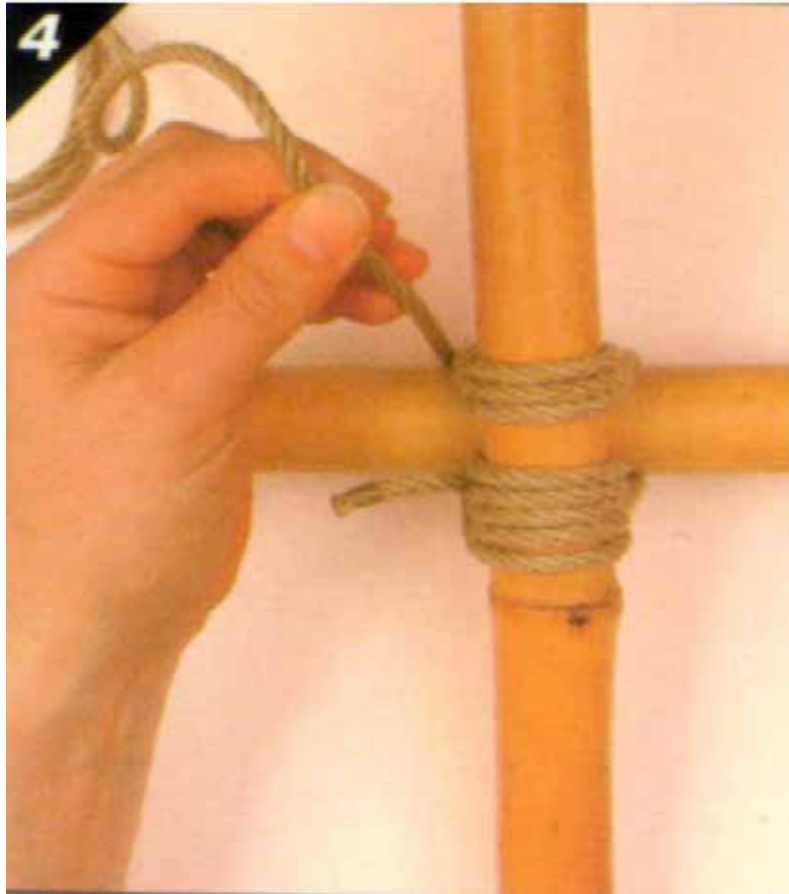

Figure 28 Step 4

*Note. From *Pocket Guide to Knots and Splices* (p. 181), by D. Pawson, 2001, London, England: Prospero Books Inc. Copyright 2001 by PRC Publishing Ltd.*

5. After passing the clove hitch, bring the cord around the horizontal pole from behind and start to wrap around the junction between the two poles. These are frapping turns—pull them as tight as possible.

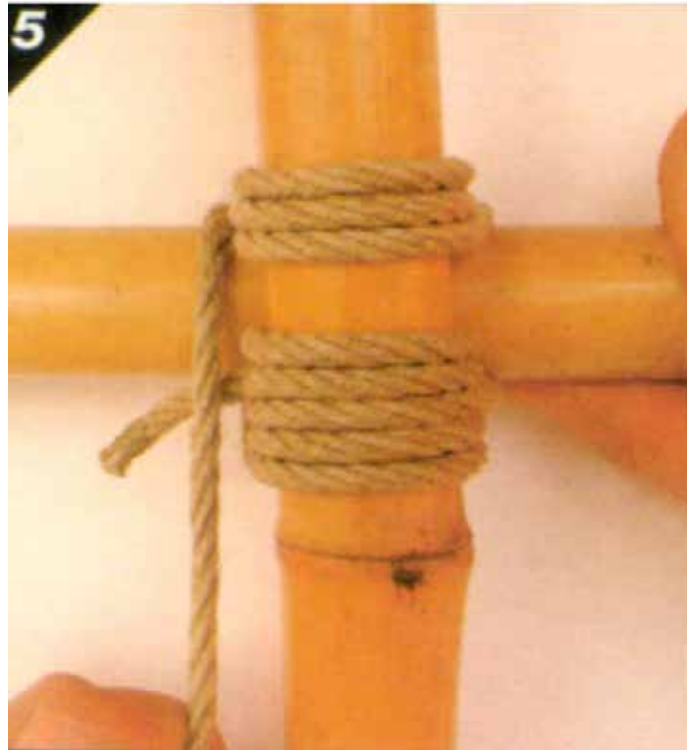

Figure 29 Step 5

Note. From *Pocket Guide to Knots and Splices* (p. 181), by D. Pawson, 2001, London, England: Prospero Books Inc. Copyright 2001 by PRC Publishing Ltd.

6. Make two frapping turns.



Figure 30 Step 6

Note. From *Pocket Guide to Knots and Splices* (p. 181), by D. Pawson, 2001, London, England: Prospero Books Inc. Copyright 2001 by PRC Publishing Ltd.

7. Finish off with a clove hitch around the horizontal pole.



Figure 31 Step 7

Note. From *Pocket Guide to Knots and Splices* (p. 181), by D. Pawson, 2001, London, England: Prospero Books Inc. Copyright 2001 by PRC Publishing Ltd.

8. Pull tight to complete the square lashing.



Figure 32 Step 8

Note. From *Pocket Guide to Knots and Splices* (p. 181), by D. Pawson, 2001, London, England: Prospero Books Inc. Copyright 2001 by PRC Publishing Ltd.

Figure-of-eight lashing. The figure-of-eight lashing is used to join three poles together to create a tripod. The tripod can be used for creating signal fires, shelters and camp crafts in a survival situation.

Steps to Lashing a Figure-of-Eight Lashing

1. Start with a clove hitch around one of the poles, and lead the rope under and over the other two poles.



Figure 33 Step 1

Note. From *Pocket Guide to Knots and Splices* (p. 187), by D. Pawson, 2001, London, England: Prospero Books Inc. Copyright 2001 by PRC Publishing Ltd.

2. Go around the pole furthest away from the start and weave the rope back over and under.



Figure 34 Step 2

Note. From *Pocket Guide to Knots and Splices* (p. 187), by D. Pawson, 2001, London, England: Prospero Books Inc. Copyright 2001 by PRC Publishing Ltd.

3. Continue to weave the rope in the figure-of-eight manner for seven or eight full passes before bringing the rope up between two of the poles.

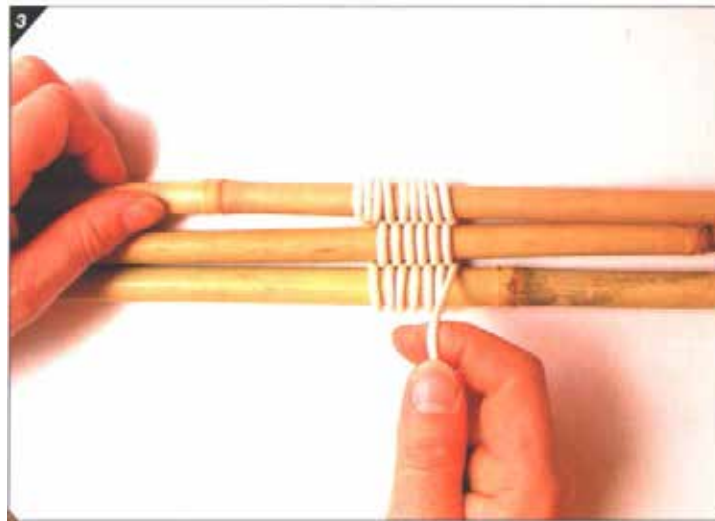

Figure 35 Step 3

Note. From *Pocket Guide to Knots and Splices* (p. 187), by D. Pawson, 2001, London, England: Prospero Books Inc. Copyright 2001 by PRC Publishing Ltd.

4. Pull the rope parallel to the poles and start to put in some frapping turns.

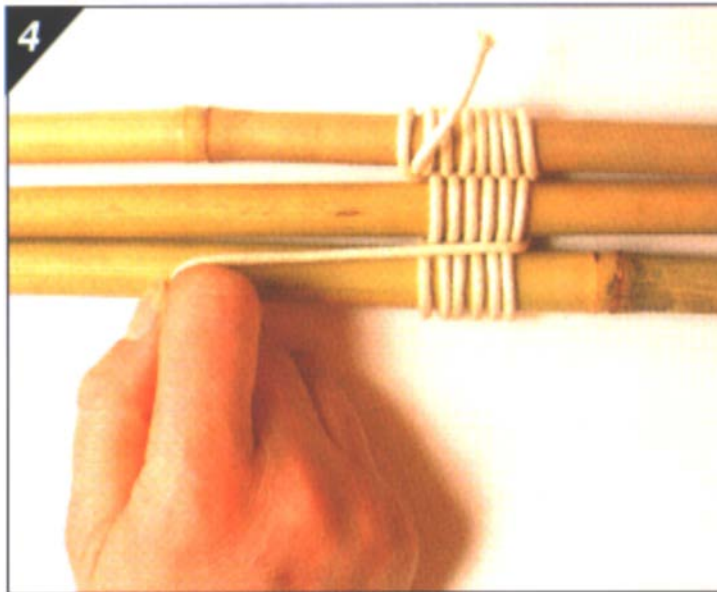

Figure 36 Step 4

Note. From *Pocket Guide to Knots and Splices* (p. 188), by D. Pawson, 2001, London, England: Prospero Books Inc. Copyright 2001 by PRC Publishing Ltd.

5. After making frapping turns between the first two poles move on to make frapping turns around the other pair of poles.

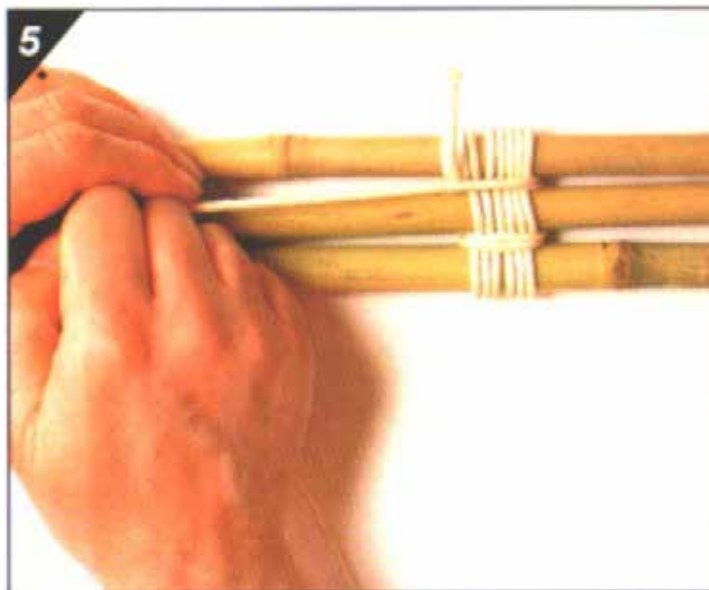

Figure 37 Step 5

Note. From *Pocket Guide to Knots and Splices* (p. 188), by D. Pawson, 2001, London, England: Prospero Books Inc. Copyright 2001 by PRC Publishing Ltd.

6. Finish off with a clove hitch around the pole from which you first started.

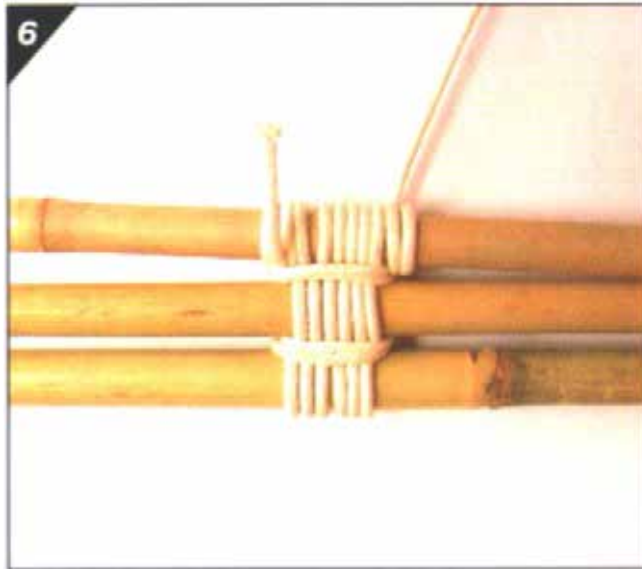

Figure 38 Step 6

Note. From *Pocket Guide to Knots and Splices* (p. 188), by D. Pawson, 2001, London, England: Prospero Books Inc. Copyright 2001 by PRC Publishing Ltd.

7. Open to create tripod.

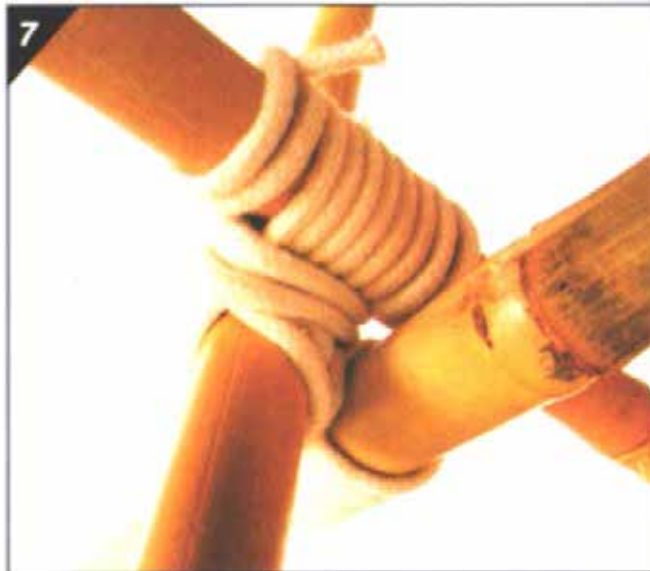

Figure 39 Step 7

Note. From *Pocket Guide to Knots and Splices* (p. 188), by D. Pawson, 2001, London, England: Prospero Books Inc. Copyright 2001 by PRC Publishing Ltd.



Distribute Attachment B to the cadets, so they may practice the knots after the lesson.

CONFIRMATION OF TEACHING POINT 3

The cadets' participation in tying lashings will serve as the confirmation of this TP.

END OF LESSON CONFIRMATION

The cadets' participation in tying knots and lashing will serve as the confirmation of this lesson.

CONCLUSION

HOMEWORK / READING / PRACTICE

Nil.

METHOD OF EVALUATION

This EO is assessed IAW A-CR-CCP-804/PG-001, *Proficiency Level Four Standard and Plan*, Chapter 3, Annex B, 490 PC.

CLOSING STATEMENT

It is important for the cadets to select the appropriate knot and lashing when constructing shelters, signal fires or camp crafts for safety and quality.

INSTRUCTOR NOTES / REMARKS

Cadets who are qualified Survival Instructor may assist with this instruction.

REFERENCES

C3-026 ISBN 1-55267-218-2 Pawson, D. (2001). *Pocket guide to knots and splices*. London, England: PRC Publishing.

KNOT-TYING INSTRUCTIONS

REEF KNOT

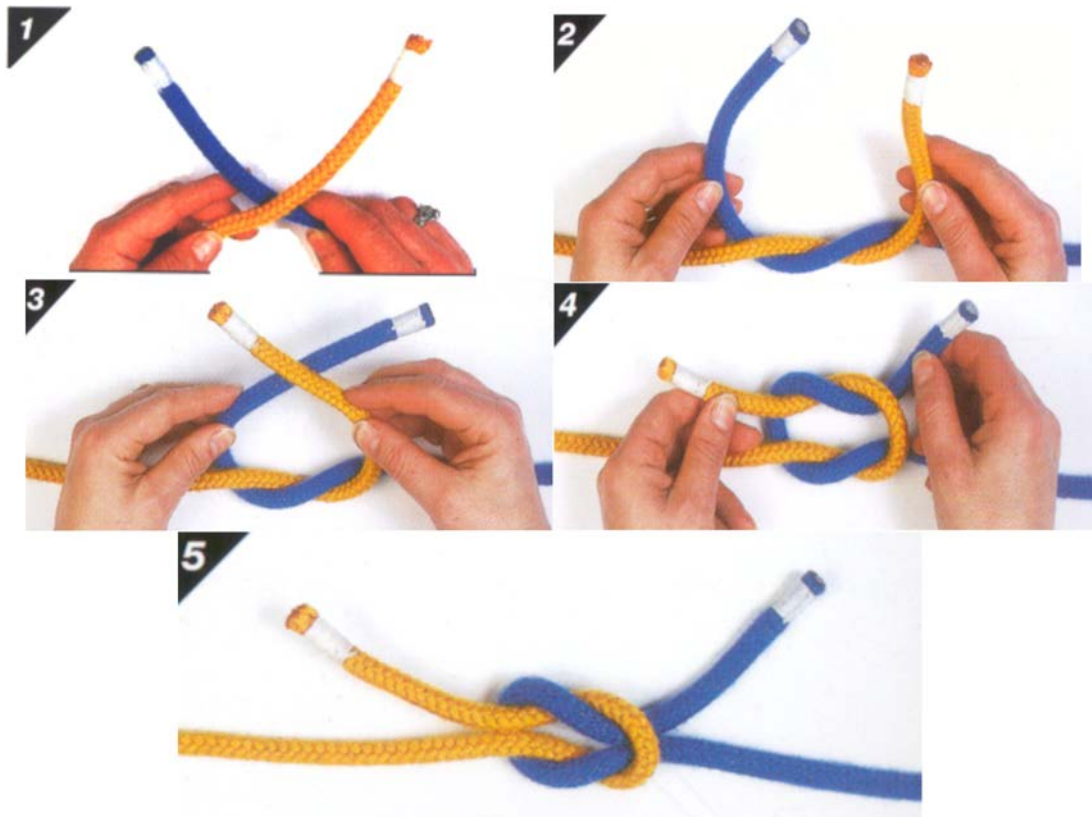

Figure A-1 Steps 1–5

*Note. From *Pocket Guide to Knots and Splices* (p. 98), by D. Pawson, 2001, London, England: Prospero Books Inc. Copyright 2001 by PRC Publishing Ltd.*

1. Place the left-hand working end on the top of the right-hand working end.
2. Bring the left-hand working end under the right-hand working end.
3. Place the working end that is now on the right on top of the working end that is now on the left.
4. Bring the working end that is on top under the other working end so that working end that is moving comes out at the same place it entered the knot.
5. Pull tight to complete the reef knot.

KNOT-TYING INSTRUCTIONS

FIGURE-OF-EIGHT KNOT



Figure A-2 Steps 1–3

Note. From *Pocket Guide to Knots and Splices* (p. 44), by D. Pawson, 2001, London, England: Prospero Books Inc. Copyright 2001 by PRC Publishing Ltd.

1. Make a crossing turn with the working end passing under the standing part of the rope and then bring the working end over the standing part.
2. Now tuck the working end up through the loop from behind, forming a figure-of-eight.
3. Pull tight to complete the figure-of-eight knot.

KNOT-TYING INSTRUCTIONS

CLOVE HITCH

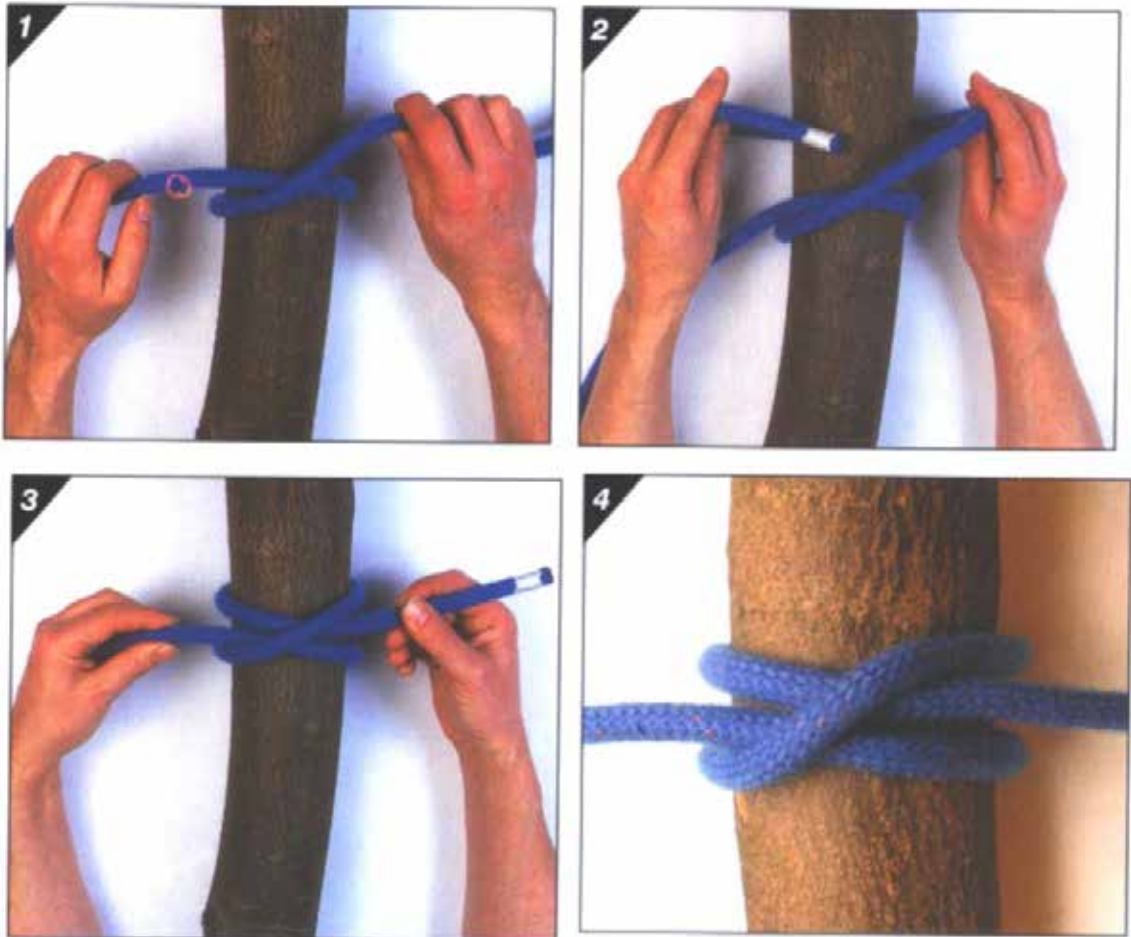

Figure A-3 Steps 1–4

Note. From *Pocket Guide to Knots and Splices* (p. 106), by D. Pawson, 2001, London, England: Prospero Books Inc. Copyright 2001 by PRC Publishing Ltd.

1. Make a turn around the pole / tree bringing the working end of the rope over and trapping the standing part of the rope. This makes the first half hitch.
2. Bring the working end round behind the pole / tree, above the first half hitch.
3. Put the working end under the turn just made. This gives the second half hitch and forms the clove hitch.
4. Pull tight to complete the clove hitch.

KNOT-TYING INSTRUCTIONS

BOWLINE

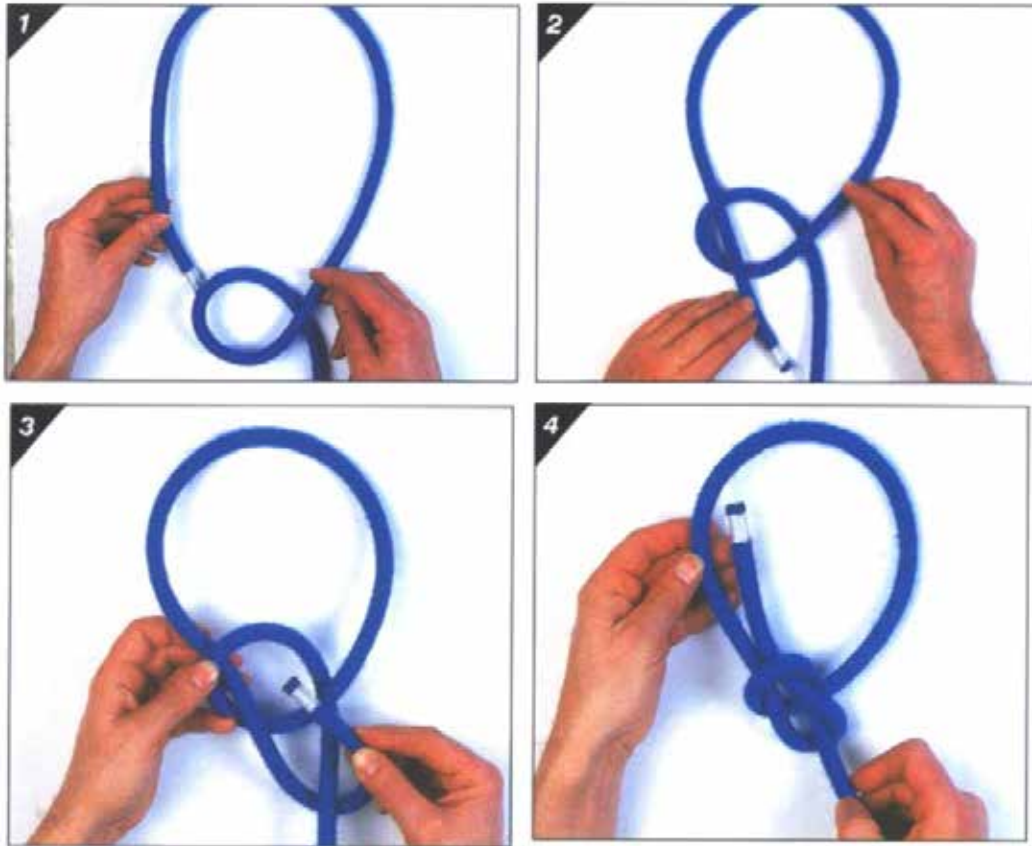

Figure A-4 Steps 1–4

Note. From *Pocket Guide to Knots and Splices* (p. 163), by D. Pawson, 2001, London, England: Prospero Books Inc. Copyright 2001 by PRC Publishing Ltd.

1. A short distance back from the working end, make a crossing turn with the working part on top. Go on to form the size of the loop you require.
2. Bring the working end up through the crossing turn. It will go under first, and then lie on top of the other part of the turn.
3. Bring the working end around behind the standing part and down through the crossing turn. A good way to remember this is: “the rabbit comes out of the hole, around the tree and back down the hole again”.
4. Pull tight by holding the working end and pulling on the standing part to complete the bowline.

LASHING INSTRUCTIONS

ROUND LASHING

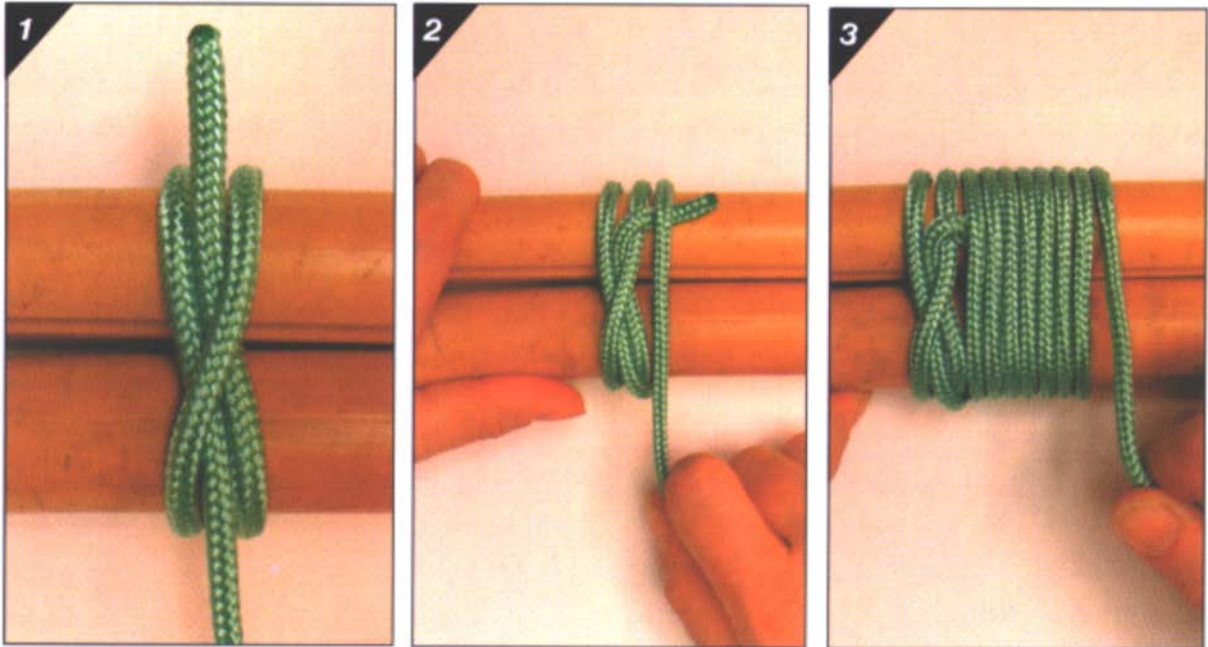

Figure B-1 Steps 1–3

Note. From *Pocket Guide to Knots and Splices* (p. 184), by D. Pawson, 2001, London, England: Prospero Books Inc. Copyright 2001 by PRC Publishing Ltd.

1. Start by making a clove hitch around both poles.
2. Wrap around both poles, trapping the end of the clove hitch.
3. Carry on making eight to ten more turns round the pair of poles.

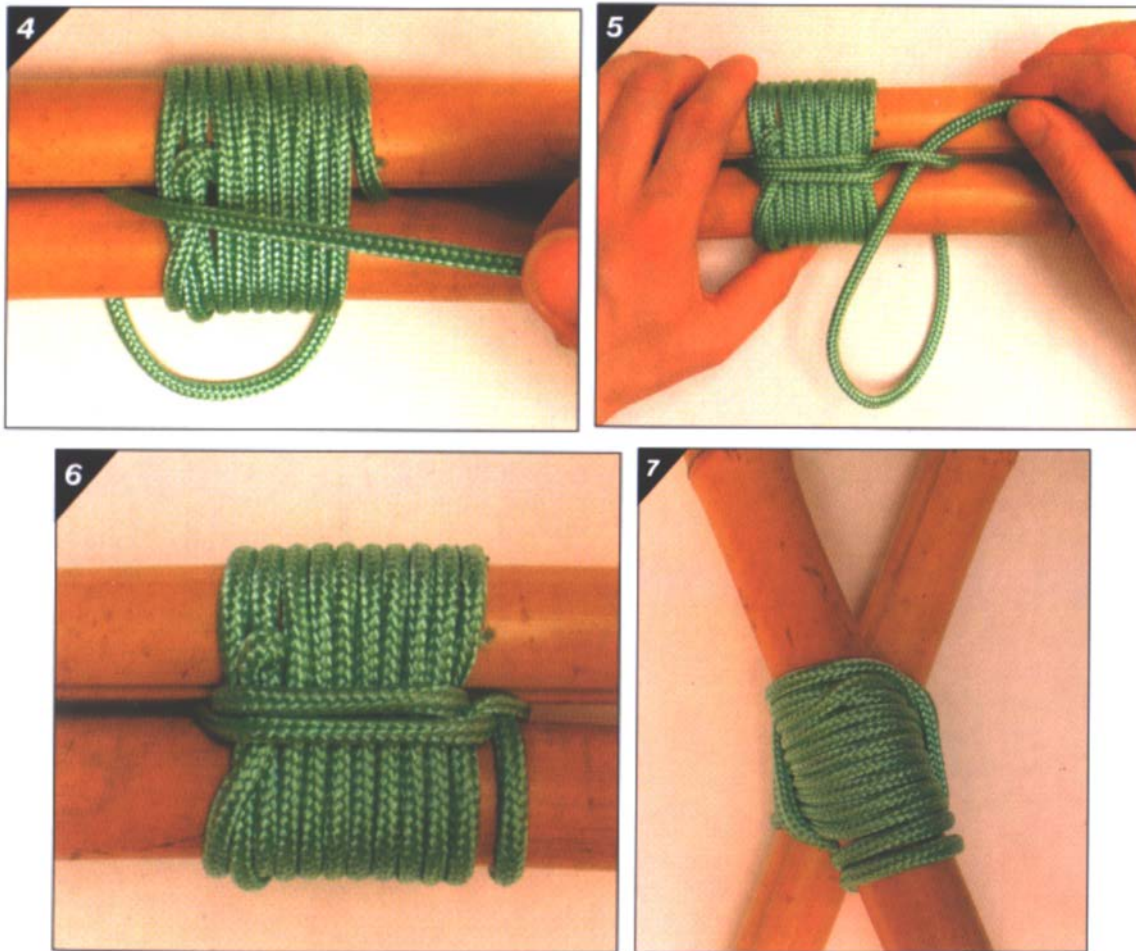

Figure B-2 Steps 4–7

Note. From Pocket Guide to Knots and Splices (p. 185), by D. Pawson, 2001, London, England: Prospero Books Inc. Copyright 2001 by PRC Publishing Ltd.

4. The lashing could now be finished with a clove hitch around both poles or put in a couple of frapping turns by bringing the end of the rope between the two poles.
5. Finish off with a clove hitch around one of the poles.
6. Pull tight to finish the round lashing with the poles parallel.
7. If being used for an "A" frame then open the poles.

LASHING INSTRUCTIONS

SQUARE LASHING

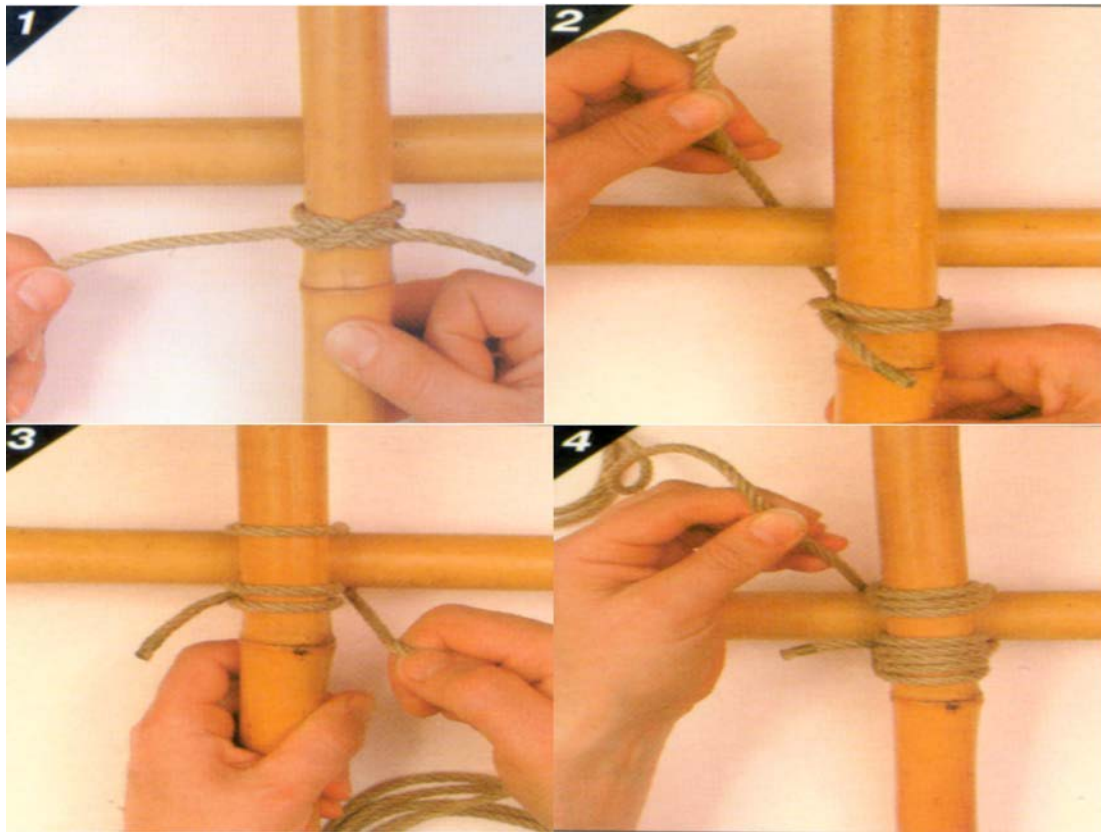

Figure B-3 Steps 1–4

Note. From *Pocket Guide to Knots and Splices* (p. 181), by D. Pawson, 2001, London, England: Prospero Books Inc. Copyright 2001 by PRC Publishing Ltd.

1. With the vertical pole on top of the horizontal pole, make a clove hitch on the vertical pole just below the horizontal pole.
2. Bring all the cord around behind the horizontal pole.
3. Bring the cord over the vertical pole and back behind the horizontal pole to the clove hitch. Pull tight.
4. Carry on making two or three more complete turns around the two poles, pulling tight after each turn.

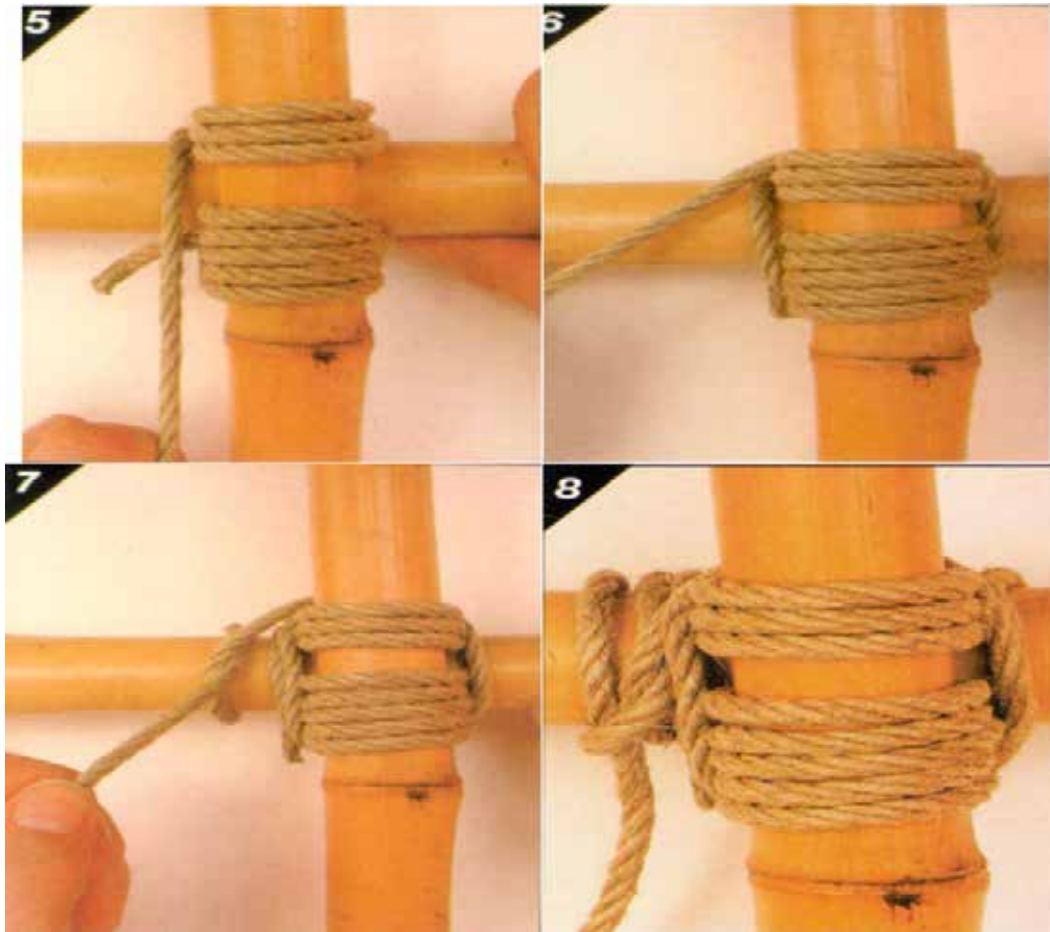

Figure B-4 Steps 5–8

*Note. From *Pocket Guide to Knots and Splices* (p. 181), by D. Pawson, 2001, London, England: Prospero Books Inc. Copyright 2001 by PRC Publishing Ltd.*

5. After passing the clove hitch, bring the cord around the horizontal pole from behind and start to wrap around the junction between the two poles. These are frapping turns—pull them as tight as possible.
6. Make two frapping turns.
7. Finish off with a clove hitch around the horizontal pole.
8. Pull tight to complete the square lashing.

LASHING INSTRUCTIONS

FIGURE-OF-EIGHT LASHING

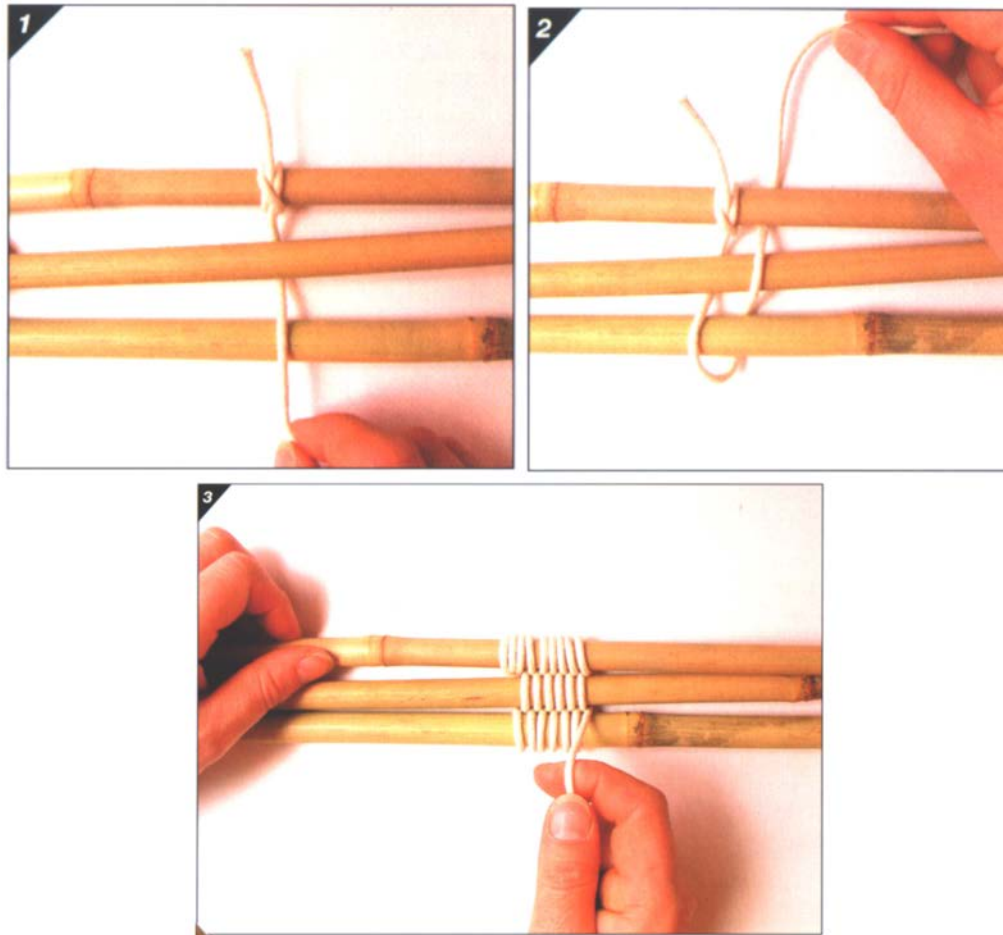

Figure B-5 Steps 1–4

Note. From *Pocket Guide to Knots and Splices* (p. 187), by D. Pawson, 2001, London, England: Prospero Books Inc. Copyright 2001 by PRC Publishing Ltd.

1. Start with a clove hitch around one of the poles, and lead the rope under and over the other two poles.
2. Go around the pole furthest away from the start and weave the rope back over and under.
3. Continue to weave the rope in the figure-of-eight manner for seven or eight full passes before bringing the rope up between two of the poles.

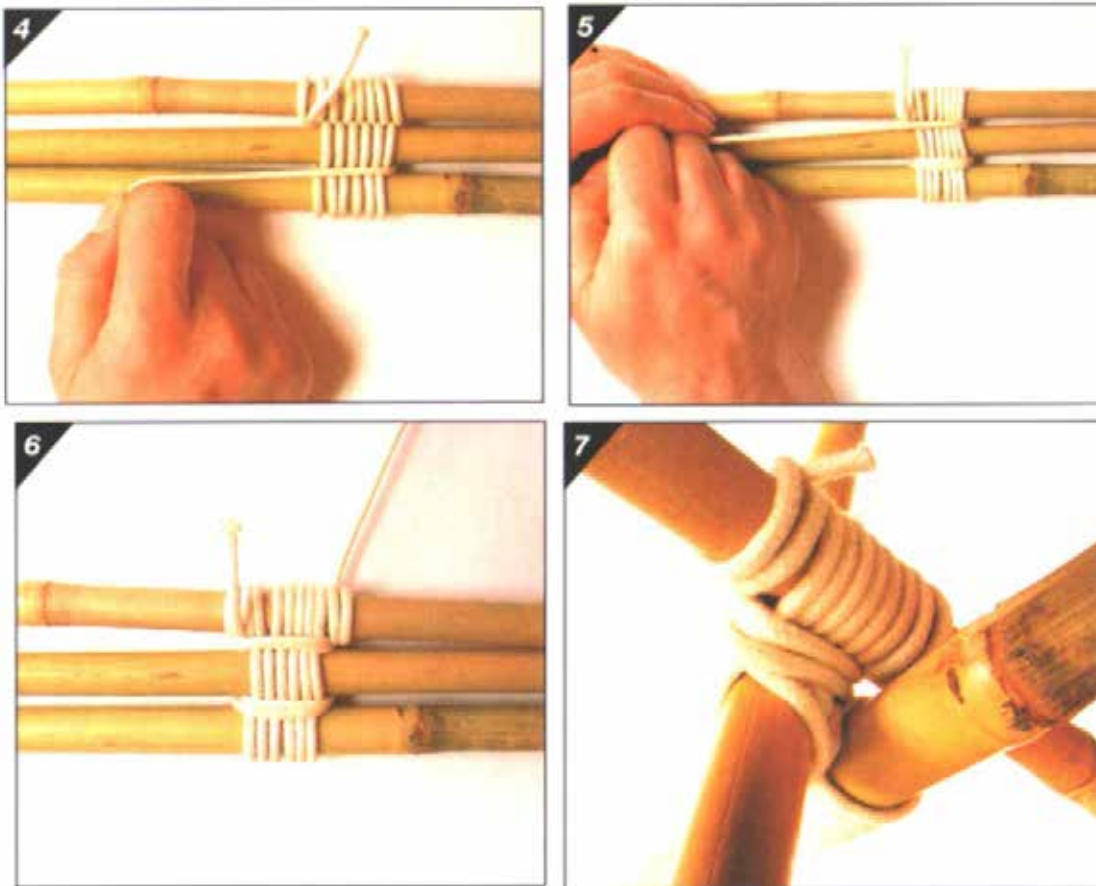

Figure B-6 Steps 4–7

Note. From *Pocket Guide to Knots and Splices* (p. 188), by D. Pawson, 2001, London, England: Prospero Books Inc. Copyright 2001 by PRC Publishing Ltd.

4. Pull the rope parallel to the poles and start to put in some frapping turns.
5. After making frapping turns between the first two poles move on to make frapping turns around the other pair of poles.
6. Finish off with a clove hitch around the pole from which you first started.
7. Open to create tripod.



ROYAL CANADIAN AIR CADETS
PROFICIENCY LEVEL FOUR
INSTRUCTIONAL GUIDE



SECTION 4

**EO M490.04 – NAVIGATE TO A WAYPOINT USING A
 GLOBAL POSITIONING SYSTEM (GPS) RECEIVER**

Total Time:	120 min
-------------	---------

PREPARATION

PRE-LESSON INSTRUCTIONS

Resources needed for the delivery of this lesson are listed in the lesson specification located in A-CR-CCP-804/PG-001, *Proficiency Level Four Qualification Standard and Plan*, Chapter 4. Specific uses for said resources are identified throughout the instructional guide within the TP for which they are required.

Review the lesson content and become familiar with the material prior to delivering the lesson.

Photocopy the GPS receiver's Functions Image and the GPS receiver's Function Key Uses pages from the GPS manual for each cadet.

Photocopy the Waypoint Form located at Attachment A and cut it in two.

Mark off five specific waypoints. The waypoints should be at a physical object (eg, tree, fence post, street marker, telephone booth, etc.). Each waypoint should have a small container or plastic bag containing an object or written clue. The waypoint should be marked to indicate it is part of this lesson. The waypoints should be between 200–500 m apart.

Test and ensure the GPS receivers and hand-held radios are functional and have fully-charged batteries.

PRE-LESSON ASSIGNMENT

Nil.

APPROACH

A demonstration was chosen for TP 1 as it allows the instructor to demonstrate and explain how to navigate to a waypoint using a GPS receiver.

A practical activity was chosen for TP 2 as it allows the instructor to introduce the GPS receiver while providing an opportunity for the cadets to practice navigating to a waypoint using a GPS receiver under supervision.

INTRODUCTION

REVIEW

Nil.

OBJECTIVES

By the end of this lesson the cadet shall have navigated to a waypoint using a GPS receiver.

IMPORTANCE

It is important for cadets to experience navigating with a GPS receiver so that they have basic knowledge of how a GPS receiver works, enabling them to use a GPS in a survival situation. The skills learned in this lesson parallel the civilian sport of geocaching.

Teaching Point 1

Explain and demonstrate turning on the GPS receiver, selecting the waypoint list, selecting a waypoint, and using the GPS receiver to move to a waypoint.

Time: 30 min

Method: Demonstration



Due to the variety of available GPS receivers, the information in this TP should reflect the model used by the cadets.



Distribute a photocopy of the GPS receiver's Functions Image and GPS receiver's Function Key Uses and explanations to each cadet.

TURNING ON A GPS RECEIVER, SELECTING THE WAYPOINT LIST AND SELECTING A WAYPOINT

Follow the GPS manual for instructions on how to turn on, select a waypoint list and select a waypoint.



Demonstrate to the cadets how to turn on the GPS and select a waypoint.

USING THE GPS TO MOVE TO A WAYPOINT

Follow the GPS manual for instructions on how to move to a waypoint.



Have the cadets practice using the GPS receiver, to include:

- turning the unit on;
- selecting the waypoint list;
- selecting a waypoint; and
- moving to the waypoint.

CONFIRMATION OF TEACHING POINT 1

The cadets' participation in using the GPS receiver will serve as the confirmation of this TP.

Teaching Point 2

Have the cadets practice navigating to a waypoint using a GPS receiver.

Time: 80 min

Method: Practical Activity

ACTIVITY

OBJECTIVE

The objective of this activity is to have the cadets practice navigating to a waypoint using a GPS receiver.

RESOURCES

- GPS receiver,
- Waypoint containers,
- Waypoint locations,
- Hand-held radio (one per group),
- Waypoint Form located at Attachment A (one per group), and
- Pen / pencil.

ACTIVITY LAYOUT

Prepared waypoints as per pre-lesson instructions.

ACTIVITY INSTRUCTIONS

1. Divide the cadets into groups of four.
2. Distribute the equipment to the cadets.
3. Have the cadets perform a radio check.
4. Demonstrate to the cadets how to complete the Waypoint Form. A sample is located at Attachment B.



The waypoints may be indicated on the Waypoint Form as either the actual waypoint or the title of a waypoint that was previously entered into the GPS (eg. Lat / Lon, or Alpha Seven).

5. Have each cadet lead the group to one of the waypoints using the GPS receiver. It is possible that one or more cadets will lead to more than one waypoint.
6. Before moving to the next waypoint, have the cadets indicate the object or written clue on the Waypoint Form.
7. Have the cadets move through the five waypoints.
8. Gather the equipment.
9. Debrief the cadets on the activity.

SAFETY

- Each group will have a separate instructor during the navigation activity.
- Ensure cadets observe pedestrian safety during the navigation activity.

CONFIRMATION OF TEACHING POINT 2

The cadets' participation in the activity will serve as the confirmation of this TP.

END OF LESSON CONFIRMATION

The cadets' participation in navigating to a waypoint along a predetermined route using a GPS receiver will serve as the confirmation of this lesson.

CONCLUSION

HOMEWORK / READING / PRACTICE

Nil.

METHOD OF EVALUATION

This EO is assessed IAW A-CR-CCP-804/PG-001, *Proficiency Level Four Standard and Plan*, Chapter 3, Annex B, 490 PC.

CLOSING STATEMENT

The GPS receiver is a very powerful navigational tool which, like so many current technologies, continues to appear in other endeavours with a revolutionary effect. If a GPS is available in a survival situation, you can move effectively to safety or rescue.

INSTRUCTOR NOTES / REMARKS

Several waypoints should be set up before this lesson.

The waypoints should be indicated on the ground or object by a marker.

The waypoints should be 200 m–500 m apart.

Cadets who are qualified Survival Instructor may assist with this instruction.

REFERENCES

C2-143 ISBN 1-58923-145-7 Featherstone, S. (2004). *Outdoor guide to using your GPS*. Chanhassen, MN: Creative Publishing International, Inc.

THIS PAGE INTENTIONALLY LEFT BLANK

WAYPOINT FORM

TEAM				
NO	WAYPOINT	CLUE	START TIME	END TIME
1				
2				
3				
4				
5				

..... Cut Here

WAYPOINT FORM

TEAM				
NO	WAYPOINT	CLUE	START TIME	END TIME
1				
2				
3				
4				
5				

THIS PAGE INTENTIONALLY LEFT BLANK

EXAMPLE OF COMPLETED WAYPOINT FORM

WAYPOINT FORM

TEAM				
NO	WAYPOINT	CLUE	START TIME	END TIME
1	60° 40' 30"N 135° 08' 30"W	Purple plastic elephant	1400 hrs	1412 hrs
2	48° 19' 50" N 070° 59' 47" W	Grey plastic army man	1415 hrs	1424 hrs
3	54° 24' 18" N 110° 16' 46" W	The word yellow	1429 hrs	1437 hrs
4	44° 16' 18" N 079° 54' 43" W	Orange peel	1445 hrs	1455 hrs
5	44° 59' 04" N 064° 55' 01" W	Blue plastic airplane	1458 hrs	1505 hrs

THIS PAGE INTENTIONALLY LEFT BLANK



**ROYAL CANADIAN AIR CADETS
PROFICIENCY LEVEL FOUR
INSTRUCTIONAL GUIDE**



SECTION 5

EO M490.05 – LIGHT FIRES USING IMPROVISED IGNITION

Total Time:	120 min
-------------	---------

PREPARATION

PRE-LESSON INSTRUCTIONS

Resources needed for the delivery of this lesson are listed in the lesson specification located in A-CR-CCP-804/PG-001, *Proficiency Level Four Qualification Standard and Plan*, Chapter 4. Specific uses for said resources are identified throughout the instructional guide within the TP for which they are required.

Review the lesson content and become familiar with the material prior to delivering the lesson.

TPs 4 and 6 should be conducted on a sunny day.

For TPs 3–6, the cadets are only required to light the tinder.

PRE-LESSON ASSIGNMENT

Nil.

APPROACH

A demonstration was chosen for TPs 1 and 2 to allow the cadets to observe lighting a fire with a bow drill and a fire piston, and to stimulate interest in lighting fires using improvised ignition.

A demonstration and performance was chosen for TPs 3–6 as it allows the instructor to explain and demonstrate lighting fires with improvised ignition and permits the cadets to practice lighting fires under supervision.

INTRODUCTION

REVIEW

Nil.

OBJECTIVES

By the end of this lesson the cadet shall be expected to light fires using improvised ignition.

IMPORTANCE

It is important for cadets to light fires using improvised ignition to demonstrate the basics for achieving the ignition of tinder. This is a fundamental skill that will enable the cadet to be warm and dry in any survival situation. Practicing these skills will enable the cadet to demonstrate these techniques to other cadets at the squadron.

Teaching Point 1**Explain and demonstrate lighting a fire using a bow drill.**

Time: 15 min

Method: Demonstration

BOW DRILL

The bow drill is one of the oldest known methods of starting a fire.

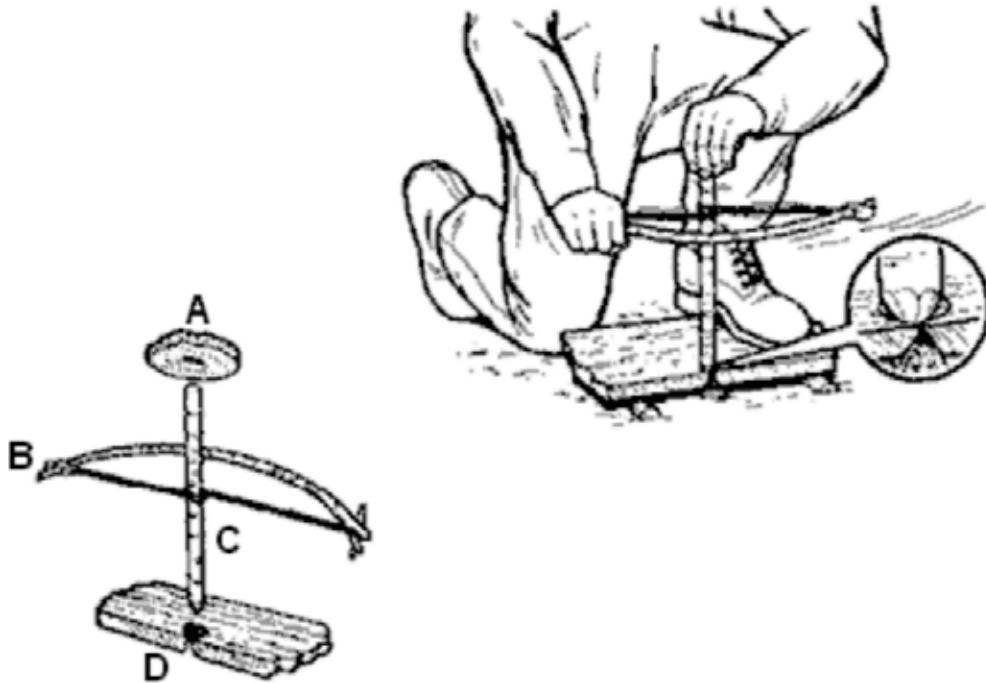

Figure 1 The Bow Drill

Note. From *U.S. Army Survival Handbook* (p. 132), by Department of the Army, 2002, Guilford, CT: The Lyons Press.

The parts of a bow drill are:

- A.** The bearing block or handhold,
- B.** The bow,
- C.** The spindle or drill, and
- D.** The hearth or fire board.

The spindle is held at one end by the bearing block and at the other by the hearth. The middle of the bow string is wrapped around the spindle one or more times. Moving the bow back and forth causes the spindle to spin. This spinning movement and pressure on the bearing block causes friction at the spindle hearth contact point.

The Bearing Block or Handhold

The bearing block can be made of anything that will protect the hand and apply pressure to the top of the spindle. Hardwood is easiest to procure, but bone, antler and stone work best as they can be easily lubricated, do not create as much friction, and do not burn. An indentation should be cut into the bottom of the block, matching the top of the spindle. The handhold can be lubricated with fat, grease, mud, soap or oil from the hair or face.

The Bow

The bow is constructed from a piece of wood and cordage. The bow string should be approximately 6 mm (1/4 inch) diameter cord. The bow should be approximately 60–75 cm (24–30 inches) long and have a curve

that measures 8–10 cm (3–4 inches) high when the ends are placed on a flat surface. The bow should be constructed from green wood or dry hardwood approximately the thickness of the thumb. Notches cut into the ends of the bow will help keep the bow string in place. A clove hitch should be used to fasten the cordage to the ends of the bow. The bow should maintain the proper tension on the bow string, allowing it to spin the spindle between the bearing block and the hearth. When using natural cordage, use less tension on the cord to prevent breakage.

The Spindle or Drill

The spindle is a piece of hard or softwood, about thumb thickness, usually 15–20 cm (6–8 inches) long. To create a properly shaped hole in the hearth, the spindle should be pointed on the bottom. To reduce friction at the top of the spindle, it should be chamfered (bevelled all around the edge) to a 45-degree angle.

The Hearth or Fire Board

The hearth is a rectangular piece of softwood, approximately 30 cm (12 inches) long, 6 cm (2 1/2 inches) wide and 1 cm (1/2 inch) thick. An indentation should be carved into the hearth, one spindle thickness in (from the edge), on the long edge of the hearth.

Using the Bow Drill

The position that a person assumes while operating the bow drill is as follows:

1. Place the right knee on the ground (assuming a right-handed operator) with the hearth located under the arch of the left foot, and the carved indentation to the right of the left foot.
2. Place the left wrist, holding the handhold, in front of the left shin to brace the hand and the handhold.
3. Hold the bow, with the cordage wrapped around the middle of the spindle, in the right hand. Place the spindle between the hearth and the handhold. Friction is achieved by pushing down on the handhold with the left hand and spinning the drill by pulling and pushing the bow with the right hand.

The hearth and spindle must be broken in before a glowing ember can be obtained. The heat of the friction between the hearth and the spindle creates charred dust. This dust will appear light brown at first. Continue spinning the spindle until the dust is dark brown. The spindle and indentation in the hearth now have matching profiles.

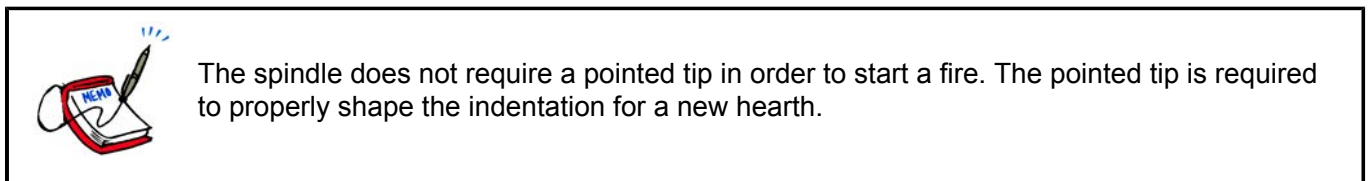

Cut a notch in the edge of the hearth perpendicular to the indentation created by the spindle. It should be wide enough to allow the dust to fall and collect in the notch. Place flat material under the notch to catch the dust and eventually the ember. Continue to spin the spindle with the bow and the dust will turn black and begin to smoke. Carefully watch for a glowing ember on the tinder. Carefully blowing on the ember will ignite the tinder.

CONFIRMATION OF TEACHING POINT 1

QUESTIONS:

- Q1. What are the four parts of a bow drill?
- Q2. What is the easiest material to find to use as a handhold?
- Q3. What is the usual position for using a bow drill?

ANTICIPATED ANSWERS:

A1. The four parts of a bow drill are:

- the bearing block or handhold,
- the bow,
- the spindle or drill, and
- the hearth or fire board.

A2. Hardwood.

A3. The usual position that a person assumes operating the bow drill is as follows:

1. Place the right knee on the ground (assuming a right-handed operator) with the hearth located under the arch of the left foot and the carved indentation to the right of the left foot.
2. Place the left wrist, holding the handhold, in front of the left shin to brace the hand and the handhold.
3. Hold the bow, with the cordage wrapped around the middle of the spindle, in the right hand. Place the spindle between the hearth and the handhold. Friction is achieved by pushing down on the handhold with the left hand and spinning the drill by pulling and pushing the bow with the right hand.

Teaching Point 2

Explain and demonstrate lighting a fire using a fire piston.

Time: 15 min

Method: Demonstration

FIRE PISTON

The fire piston is an ancient method of starting fires. It is believed to have originated in areas that developed blowguns in East Asia.

The fire piston is a unique method of producing fire. Fire pistons rely on the principle that compressing a volume of air raises its temperature. This is the same principle that is used in diesel engines. If air is compressed quickly enough, it can ignite tinder.

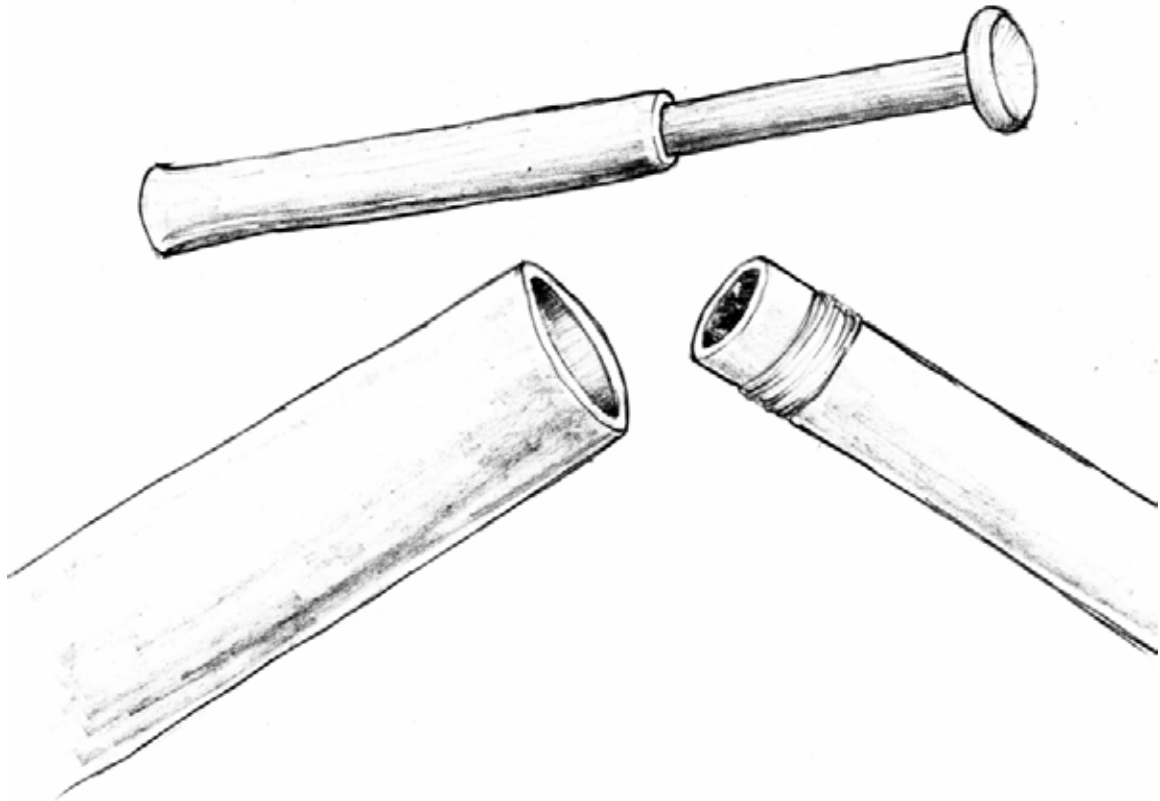

Figure 2 Fire Piston

Note. Created by Director Cadets 3, 2009, Ottawa, ON Department of National Defence.

A fire piston consists of a closed end cylinder and a plunger. The plunger should fit into the cylinder with an airtight seal. Tinder is placed into the cylinder (or in a hole on the end of the plunger) and the plunger is inserted a short way into the cylinder. The plunger is quickly forced down into the cylinder, compressing the air and raising its temperature, igniting the tinder and creating an ember. The movement is similar to smacking the plunger into the cylinder. The compressed air in the cylinder pushes the plunger outward. The plunger is quickly removed and the ember carefully removed and placed into a larger bundle of tinder and then blown into flame.

Traditionally, bamboo was used to construct fire pistons but they can be crafted from metal tubing salvaged from an aircraft or vehicle or carefully carved from hardwood.

CONFIRMATION OF TEACHING POINT 2

QUESTIONS:

- Q1. What principle does the fire piston use?
- Q2. What are the two main parts of a fire piston?
- Q3. From what material can fire pistons be crafted?

ANTICIPATED ANSWERS:

- A1. Fire pistons rely on the principle that compressing a volume of air raises its temperature.
- A2. The cylinder and plunger.
- A3. Traditionally, bamboo was used to construct fire pistons but they can be crafted from metal tubing salvaged from an aircraft or vehicle or carefully carved from hardwood.

Teaching Point 3

Explain, demonstrate and have the cadets light a fire using a magnesium fire starter.

Time: 20 min

Method: Demonstration and Performance



For this skill lesson, it is recommended that instruction take the following format:

1. Explain and demonstrate the complete skill while cadets observe.
2. Explain and demonstrate each step required to complete the skill. Monitor cadets as they imitate each step.
3. Monitor the cadets' performance as they practice the complete skill.

Note: Assistant instructors may be employed to monitor cadet performance.

Magnesium is a metal, that when powdered or shaved, will ignite from a spark. It burns at a very high temperature, making it an effective way to light a fire.

A magnesium fire starter consists of a piece of magnesium and a striking rod. Shaved off pieces of magnesium can be used with a rock or steel object to strike a spark onto the shavings.



Figure 3 Magnesium Fire Starter

Note. Created by Director Cadets 3, 2009, Ottawa, ON, Department of National Defence

The steps to use a magnesium fire starter are:

1. Prepare the area for the fire by assembling tinder and wood for the fire.
2. Place the bottom edge of the magnesium block on a small rock or piece of wood next to the tinder. The small rock or piece of wood will prevent the magnesium block from sinking into soft ground during the shaving process.
3. Using a knife blade, scrape the magnesium, making a small pile approximately the size of a quarter, at the base of the block.



The magnesium shavings are very light in weight. When experiencing high wind conditions, use your body or an object as a wind block and create a small depression where the block is resting on to catch the shavings.

4. Support the edge of the tool on the small rock or piece of wood approximately 25 cm (1 inch) from the pile of magnesium shavings. Using a piece of steel or a sharp rock, strike the sparking side of the magnesium

block. Position the magnesium block so the spray of sparks is directed onto the pile of magnesium shavings. This will ignite the magnesium shavings.



Always move the tinder to the magnesium. The burning magnesium is too hot to handle. Carefully place pieces of tinder on the pile of burning magnesium shavings.

ACTIVITY

Time: 5 min

OBJECTIVE

The objective of this activity is to have the cadets light a fire using a magnesium fire starter.

RESOURCES

- Magnesium fire starter,
- Knife,
- Tinder, and
- Pails of sand.

ACTIVITY LAYOUT

Nil.

ACTIVITY INSTRUCTIONS

1. Distribute the magnesium fire starters, knives, and tinder to each cadet.
2. Have each cadet scrape the magnesium block to produce a pile of shavings.
3. Have each cadet ignite the shavings and then add tinder to the burning magnesium.
4. After confirmation that the tinder has been lit, have the cadets extinguish the burning tinder using sand.
5. Gather the equipment.
6. Debrief the cadets on the activity.

SAFETY

Magnesium burns at a temperature of approximately 2200 degrees Celsius. The flames from burning magnesium seldom pass 30 cm in height. It will only burn as shavings or dust.

Burning magnesium is hard to extinguish as it can burn in nitrogen and carbon dioxide.

Under no circumstances should water be used to extinguish a magnesium fire.

A carbon dioxide (CO₂) fire extinguisher will not extinguish a magnesium fire.

Sand can be used to extinguish a magnesium fire.

CONFIRMATION OF TEACHING POINT 3

The cadets' participation in the activity will serve as the confirmation of this TP.

Teaching Point 4**Explain, demonstrate and have the cadets light a fire using an aluminium can and a bar of chocolate.**

Time: 20 min

Method: Demonstration and Performance



Dark tinted sunglasses will help alleviate eye strain and allow visual confirmation of the focal point.



For this skill lesson, it is recommended that instruction take the following format:

1. Explain and demonstrate the complete skill while cadets observe.
2. Explain and demonstrate each step required to complete the skill. Monitor cadets as they imitate each step.
3. Monitor the cadets' performance as they practice the complete skill.

Note: Assistant instructors may be employed to monitor cadet performance.

When the Sun's rays are focused, either through a lens or a concave reflector, they can generate enough heat to ignite tinder. The bottom of an aluminum can may have a concave shape suitable for focusing the Sun's rays. Polishing this concave shape with a compound will allow it to focus the Sun's rays. Possible polishing compounds can include:

- toothpaste,
- sink cleaner,
- chocolate, or
- very fine steel wool.

Toothpaste and sink cleaner have an aggressive grit and will polish the concave bottom quickly but will be less reflective. Chocolate has a fine grit and can take up to one hour to polish the concave bottom. The type of chocolate used can affect the time required to polish the bottom. Pure dark chocolate is best. Chocolate with nuts or raisins may take longer to polish the can. White chocolate usually does not have an abrasive quality. If more than one type of polish is available, start the process with the coarsest polishing compound and finish with the finest.



The aluminum particles removed from the can's bottom are considered harmful. They appear as a blackening of the polishing compound. Do not put any substance used in polishing in the mouth. Wash hands before eating. Do not eat the chocolate used to polish the can's bottom.



Figure 4 Polishing the Aluminum Can Bottom

Note. From "Fire from a can of coke and a chocolate bar", by W. Muma, 2003, *Wildwood Survival*, Copyright 2003 by W. Muma. Retrieved April 6, 2009, from <http://www.wildwoodsurvival.com/survival/cokecanandchocolatebar/index.html>

Polishing the Aluminium Can Base

Apply some polishing compound to a soft cloth. If using chocolate, the wrapper can be used as the polishing cloth. Polish the bottom of the can in a circular motion until the bottom has a mirror finish. The polishing will remove any evidence of printed information on the can's bottom. Embossed numbers or letters will not affect the can's ability to focus the Sun's rays.



Figure 5 Verifying the Polish

Note. From "Fire from a can of coke and a chocolate bar", by W. Muma, 2003, *Wildwood Survival*, Copyright 2003 by W. Muma. Retrieved April 6, 2009, from <http://www.wildwoodsurvival.com/survival/cokecanandchocolatebar/index.html>

The state of polish can be verified by examining the reflection of an object in the centre of the bottom of the can. Look for a clear reflection.

Igniting Tinder with the Focused Rays of the Sun

Several factors must be addressed when using this method. Full sun is required to use the can's polished bottom to ignite the tinder. The tinder must be very dry and sized to allow as much of the sun's rays as possible to enter the concave bottom of the can. The tinder must be centred at the focal point of the sun's rays. The can bottom and the tinder should be held still and close to the face to allow blowing on the tinder. Some types of tinder will smoke but will not ignite unless air is added. This is done by blowing gently on the tinder while the sun's rays are focused on it.



Figure 6 Large Ring of Light

Note. From "Fire from a can of coke and a chocolate bar", by W. Muma, 2003, *Wildwood Survival*, Copyright 2003 by W. Muma. Retrieved April 6, 2009, from <http://www.wildwoods survival.com/survival/cokecanandchocolatebar/index.html>



Figure 7 Medium Ring of Light

Note. From "Fire from a can of coke and a chocolate bar", by W. Muma, 2003, *Wildwood Survival*, Copyright 2003 by W. Muma. Retrieved April 6, 2009, from <http://www.wildwoods survival.com/survival/cokecanandchocolatebar/index.html>



Figure 8 Focused Spot of Light

Note. From "Fire from a can of coke and a chocolate bar", by W. Muma, 2003, *Wildwood Survival*, Copyright 2003 by W. Muma. Retrieved April 6, 2009, from <http://www.wildwoodsurvival.com/survival/cokecanandchocolatebar/index.html>



Figure 9 Using the Aluminum Can and Tinder

Note. From "Fire from a can of coke and a chocolate bar", by W. Muma, 2003, *Wildwood Survival*, Copyright 2003 by W. Muma. Retrieved April 6, 2009, from <http://www.wildwoodsurvival.com/survival/cokecanandchocolatebar/index.html>

The focal point of the Sun's rays passing through a convex lens or reflected by a concave reflector is the hottest point. This is where the tinder will ignite. To find the focal point, hold the can in one hand with the bottom pointed directly to the sun. The tinder can be placed on the end of a twig to avoid blocking the Sun's rays from the can's bottom.

To determine the best position for the can, hold the twig with the tinder so that the tinder is approximately three cm from the bottom of the centre of the can. Keep fingertips to the side of the can. The tinder can also be long and thin to avoid blocking sunlight (eg, birch bark, dry grass, slice of shelf mushroom).

Adjust the angle of the can by looking at the ring of light projected onto the underside of the tinder until the oval of sunlight becomes a circle. Sunglasses are recommended for this operation. Bring the tinder closer to or further from the bottom of the can until the circle of sunlight becomes the smallest dot possible. In a few moments, the tinder will start to smoke.

ACTIVITY

Time: 10 min

OBJECTIVE

The objective of this activity is to have the cadets light tinder using the polished concave bottom of an aluminum can and polishing compound.

RESOURCES

- Dark tinted sunglasses (one per cadet),
- Aluminum can (one per cadet),
- Chocolate,
- Toothpaste,
- Tinder, and
- Pails of sand.

ACTIVITY LAYOUT

Nil.

ACTIVITY INSTRUCTIONS

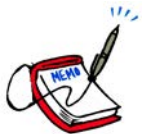

Polishing the bottom of the aluminum can with chocolate may take up to one hour. Toothpaste is preferred as a polish for this TP. If the cadets cannot finish in the allocated time, polishing of the aluminum can be done on their own time.

1. Distribute an aluminum can, piece of cloth and a dab of toothpaste to each cadet.
2. Have the cadets polish the bottom of the can with the polishing compound.
3. Wearing sunglasses, have the cadets practice establishing the focal point on the tinder.
4. After confirmation that the tinder has been lit, have the cadets extinguish all glowing / lit tinder using sand.
5. Gather the equipment.
6. Debrief the cadets on the activity.

SAFETY

A fire extinguisher and pails of sand shall be available at the site.

CONFIRMATION OF TEACHING POINT 4

The cadets' participation in the activity will serve as the confirmation of this TP.

Teaching Point 5

Explain, demonstrate and have the cadets light a fire using a battery, wire and steel wool.

Time: 20 min

Method: Demonstration and Performance

Like magnesium, steel is another metal that can burn when it is shaved or in powder form. Steel wool is made by shaving thin strands of iron off iron wire. It is used in wood and metal manufacturing as a mild abrasive and polish.



Figure 10 Using Batteries and Steel Wool

Note. From "Steel wool and a battery", 2003, *Practicalsurvivor.com*, Copyright 2003. Retrieved April 7, 2009, from <http://www.practicalsurvivor.com/node/32>



Figure 11 Battery and Steel Wool Ignition

Note. From "Steel wool and a battery", 2003, *Practicalsurvivor.com*, Copyright 2003. Retrieved April 7, 2009, from <http://www.practicalsurvivor.com/node/32>

When an electrical current passes through the strands of steel wool, the electrical resistance of the steel strands causes them to oxidize quickly enough to ignite and burn. The size and shape of the wool allows it to burn. Fine steel wool works best. Adding oxygen to the steel wool by blowing on it will increase the rate of oxidation, causing greater heat. Steel wool will burn when wet. The finer the grade of steel wool, the faster it will burn.

One battery (AA, C and D cell) does not have enough voltage and amperage to ignite the steel wool by itself. Two batteries (AA, C and D cell), a nine volt battery, cell phone or radio battery will ignite the steel wool but this will drain the batteries quickly. This use of batteries should be evaluated carefully as the batteries may be more useful in an object like a GPS, cell phone or radio.

To use steel wool and batteries:

1. Pull the steel wool into a multi-strand bundle long enough to reach both battery terminals.
2. Prepare tinder where the fire will be lit.
3. Place one end of the bundle on one terminal of the batteries.
4. Place the other end of the bundle on the opposite battery terminal.

The bundle of steel wool will ignite immediately and can be added to the tinder.

Steel wool can also be ignited by a spark from flint (hard rock) and steel, the flint of a empty lighter or any other source of spark.

ACTIVITY

Time: 10 min

The objective of this activity is to have the cadets light a fire using a battery and steel wool.

RESOURCES

- AA batteries (two per cadet),
- Tinder,
- Pails of sand, and
- Steel wool.

ACTIVITY LAYOUT

Nil.

ACTIVITY INSTRUCTIONS

1. Distribute the batteries, steel wool and tinder to the cadets.
2. Have the cadets crouch down to the ground and ignite the steel wool with the batteries.
3. Have the cadet place the tinder on the burning steel wool and blow gently on it to ignite the tinder.
4. After confirmation that the tinder is lit, have the cadets extinguish the tinder using sand.
5. Gather the equipment.
6. Debrief the cadets on the activity.

SAFETY

A fire extinguisher and pails of sand shall be available at the site.

CONFIRMATION OF TEACHING POINT 5

The cadets' participation in the activity will serve as the confirmation of this TP.

Teaching Point 6

Explain, demonstrate and have the cadets light a fire using a magnifying lens.

Time: 20 min

Method: Demonstration and Performance

A magnifying lens will accomplish the same objective as the bottom of the aluminum can. It will focus the sun's rays into one point that will ignite tinder. It can be made of glass, plastic, ice or water.

Glass or plastic lenses can be obtained from:

- a magnifying glass,
- binoculars,

- a camera, or
- eyeglasses.

The type of tinder will dictate how much effort will be required to ignite it. Average tinder and a small lens will require additional air to ignite.



Figure 12 Using Binoculars to Ignite Tinder

Note. From "Magnifying lens", by W. Muma, 2003, *Wildwood Survival*, Copyright 2003 by W. Muma. Retrieved April 6, 2009, from <http://www.wildwoodsurvival.com/survival/fire/magnifier.html>

Larger and thicker lenses will generate higher temperatures at the focal point but the point may be too far from the lens to be effective. Most eyeglasses will prove difficult to use lighting fires as they do not have the magnification necessary to ignite tinder. Experimentation is necessary to find the focal point of a lens or set of lenses. Before disassembling an object containing lenses, evaluate its worth during the survival situation.

Fire From Ice



Figure 13 Rough Carved Sphere of Ice

Note. From "Fire from ice", by W. Muma, 2003, *Wildwood Survival*, Copyright 2003 by W. Muma. Retrieved April 6, 2009, from <http://www.wildwoodsurvival.com/survival/fire/ice/rb/rbfirefromice4b.html>



Figure 14 Polishing a Sphere of Ice

Note. From "Fire from ice", by W. Muma, 2003, *Wildwood Survival*, Copyright 2003 by W. Muma. Retrieved April 6, 2009, from <http://www.wildwoods survival.com/survival/fire/ice/rb/rbfirefromice4b.html>



Figure 15 Using a Piece of Tubing to Shape an Ice Sphere

Note. From "Fire from ice", by W. Muma, 2003, *Wildwood Survival*, Copyright 2003 by W. Muma. Retrieved April 6, 2009, from <http://www.wildwoodsurvival.com/survival/fire/ice/rb/rbfirefromice4b.html>



Figure 16 Igniting Tinder with an Ice Sphere

Note. From "Fire from ice", by W. Muma, 2003, *Wildwood Survival*, Copyright 2003 by W. Muma. Retrieved April 6, 2009, from <http://www.wildwoodsurvival.com/survival/fire/ice/rb/rbfirefromice4b.html>

Spherical ice lenses can be made in cold climates. A sphere of ice used as a lens will give a usable focal point that can be used to ignite tinder. Ice from a lake or shore of a river that is free of air bubbles and crystal clear is necessary for this method of fire lighting. The sphere should be larger than 4 cm (1 1/2 inches) to be effective.

To make a spherical lens of ice:

1. Start by cutting the rough shape from a larger block of ice.
2. Once the spherical shape has been established, turn the sphere in bare hands to smooth and polish the surface. If a metal tube is available (eg. aircraft exhaust or spar tubing) spinning the sphere on the end of the tube will shave it almost perfectly round. The tubing must be slightly smaller in diameter than the ice sphere.
3. The sphere can be held by wrapping a strip of cloth or bootlace around its circumference and twisting it tight.

Fire From Water



Figure 17 Igniting Tinder with Plastic Wrap and Water

Note. From "Fire from ice", by W. Muma, 2003, *Wildwood Survival*, Copyright 2003 by W. Muma.
Retrieved April 6, 2009, from <http://www.wildwoodsurvival.com/survival/fire/ice/rb/rbfirefromice4b.html>

A clear piece of plastic wrap, balloon or condom can also be used if partially filled with water. The object is to make a perfect sphere by twisting the open end tight so the plastic takes a spherical shape. The Sun's rays can then be focused on the tinder.

1. Place some water in the plastic. The sphere should be larger than 4 cm (1 1/2 inches) to be effective.
2. Twist the opening tightly to form a sphere.

3. Hold the sphere between the tinder and the sun.
4. Locate the focal point and ignite the tinder.



Figure 18 Igniting Tinder with a Broken Light Bulb and Water

Note. From "Fire from ice", by W. Muma, 2003, *Wildwood Survival*, Copyright 2003 by W. Muma.
Retrieved April 6, 2009, from <http://www.wildwoodsurvival.com/survival/fire/ice/rb/rbfirefromice4b.html>

A piece of broken light bulb, wine glass or any other round clear object holding some water can also be used to focus the Sun's rays.

ACTIVITY

Time: 10 min

OBJECTIVE

The objective of this activity is to have the cadets ignite tinder using a magnifying lens.

RESOURCES

- Magnifying lens,
- Clear plastic bag,
- Water,
- Tinder, and
- Pails of sand.

ACTIVITY LAYOUT

Nil.

ACTIVITY INSTRUCTIONS

1. Have the cadet select a method of ignition from:
 - a. magnifying lens, or
 - b. clear plastic bag.
2. Distribute lens or clear plastic bag and water and tinder to the cadets.
3. Have the cadets ignite the tinder with the selected lens.
4. After confirmation that the tinder is lit, extinguish the tinder using sand.
5. Gather the equipment.
6. Debrief the cadets on the activity.

SAFETY

A fire extinguisher and pails of sand shall be available at the site.

CONFIRMATION OF TEACHING POINT 6

The cadets' participation in the activity will serve as the confirmation of this TP.

END OF LESSON CONFIRMATION

The cadets' participation in the activities will serve as the confirmation of this lesson.

CONCLUSION

HOMEWORK / READING / PRACTICE

Nil.

METHOD OF EVALUATION

This EO is assessed IAW A-CR-CCP-804/PG-001, *Proficiency Level Four Standard and Plan*, Chapter 3, Annex B, 490 PC.

CLOSING STATEMENT

There are many methods for igniting tinder in a survival situation. The ones demonstrated in this lesson should be practiced often. The heat and warmth of a fire can be a necessity in a survival situation.

INSTRUCTOR NOTES / REMARKS

Petroleum products such as gasoline should be handled with care due to its combustible properties. Avoid skin contact. Refer to Material Safety Data Sheet (MSDS).

Cadets who are qualified Survival Instructor may assist with this instruction.

REFERENCES

C3-002 ISBN 0-00-653140-7 Wiseman, J. (1999). *The SAS survival handbook*. Hammersmith, London: HarperCollins Publishers.

C3-003 ISBN 1-896713-00-9 Tawrell, P. (1996). *Camping and wilderness survival: The ultimate outdoors book*. Green Valley, ON: Author.

C3-314 Wildwood Survival. (2009). *Fire from a can of coke and a chocolate bar*. Retrieved February 9, 2009, from <http://www.wildwoodsurvival.com/survival/fire/cokeandchocolatebar/index.html>

C3-315 Primitive Ways. (1996). *The fire piston: Ancient firemaking machine*. Retrieved February 9, 2009, from http://www.primitiveways.com/fire_piston.html



ROYAL CANADIAN AIR CADETS
PROFICIENCY LEVEL FOUR
INSTRUCTIONAL GUIDE



SECTION 6

EO C490.01 – DESCRIBE CLIMATIC AND SEASONAL CONCERNS

Total Time: 30 min

PREPARATION

PRE-LESSON INSTRUCTIONS

Resources needed for the delivery of this lesson are listed in the lesson specification located in A-CR-CCP-804/PG-001, *Proficiency Level Four Qualification Standard and Plan*, Chapter 4. Specific uses for said resources are identified throughout the instructional guide within the TP for which they are required.

Review the lesson content and become familiar with the material prior to delivering the lesson.

PRE-LESSON ASSIGNMENT

Nil.

APPROACH

An interactive lecture was chosen for TP 1 to give an overview of climate concerns.

A group discussion was chosen for TP 2 as it allows the cadets to interact with their peers and share knowledge, experiences, opinions, and feelings about seasonal concerns associated with spring, summer, autumn, and winter weather. This helps develop rapport by allowing the instructor to evaluate the cadets' responses in a non-threatening way while helping them refine their ideas. A group discussion also helps the cadets improve their listening skills and develop as members of a team.

INTRODUCTION

REVIEW

Nil.

OBJECTIVES

By the end of this lesson the cadet shall have described climatic and seasonal factors that affect survival situations.

IMPORTANCE

It is important for cadets to describe seasonal concerns, so they can apply the knowledge in a survival situation.

Teaching Point 1**Describe climate associated with regions and climate change.**

Time: 15 min

Method: Interactive Lecture

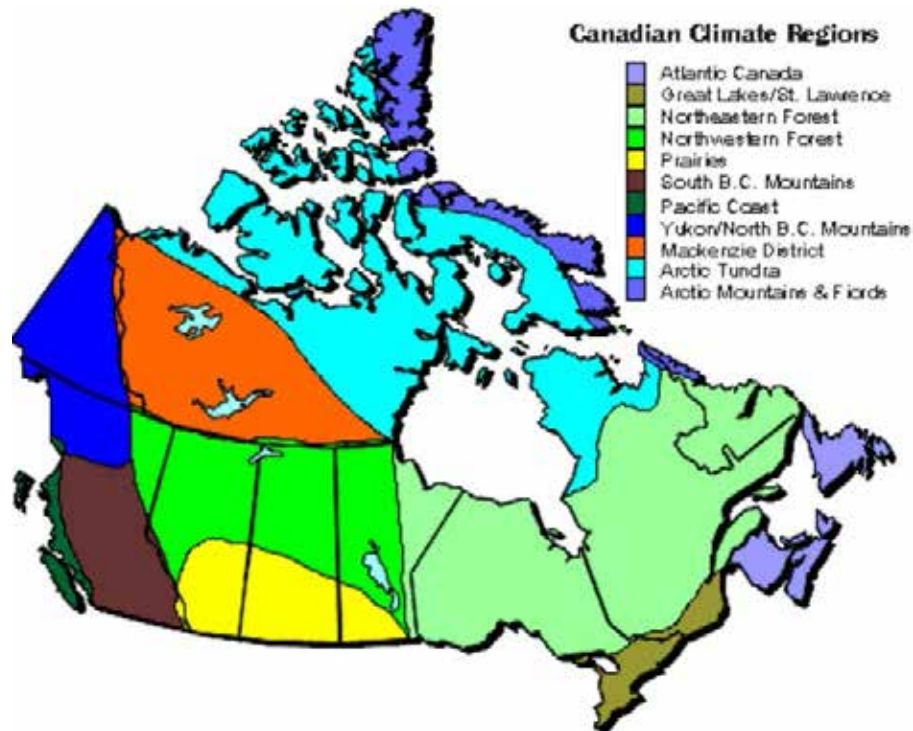

Figure 1 Climate Map

Note. From *Canadian Regional Climates*, 2002, by Environment Canada. Retrieved April 17, 2009, from http://www.msc-smc.ec.gc.ca/ccrm/bulletin/figclimate_e.html

It is important to understand each regional climate zone. If an individual is lost or in a survival situation, it is good to know the climate of the region they are surviving in. Canada has 11 regional climates (as illustrated in Figure 1).

CANADIAN REGIONAL CLIMATE**The West Coast**

British Columbia's coast has the most temperate climate in Canada. It rarely snows in the low-lying areas of the coastal range and the Rocky Mountains block the Pacific air from the Prairies. The valleys between the mountain ranges experience hot summers, almost completely precipitation free.

The Prairies

The Prairies extend east of the Rocky Mountains to the Great Lakes. The Prairies has predominant climate, with the cold winters and humid, hot summers.

The Great Lakes–St. Lawrence

More than half of the population of Canada lives here. The winters have a lot of snowfall and wind and the summers are humid and longer than anywhere else in Canada.

Atlantic Canada

It has one of the most rugged and variable climates in Canada. In the winter, temperatures can vary as the arctic air is replaced by maritime air from passing storm systems. The snowfall is heavy and fog is often present in the spring and at the beginning of summer. The warmest time of the year is in July, as temperatures average 16–18 degrees Celsius.

The North

The North is mostly covered in snow during the year. The summer lasts for two months and the temperatures rise above freezing for only a few weeks of the year. The temperatures are so cold that the ground is frozen all year long.

CLIMATE CHANGE

Environmental Impact

Canada's climate has increased by 1.3 degrees Celsius since 1948, with the Arctic experiencing the greatest changes of all regions. The warming in the Arctic has led to a decrease in snow cover and sea ice, a degradation of permafrost, and a retreat of glaciers and ice caps. To the south of the Arctic, the winter snow is melting earlier and glaciers are disappearing.

The water levels of the Great Lakes are dropping and sea levels are rising. The temperature increase is causing a longer growing season for plant vegetation.

The climate change is causing increases in related hazards, such as heat waves, droughts, floods, forest fires, storm surges, and coastal erosion. These hazards are not only costly (damage to property and infrastructure) but can be life threatening if climate change increases significantly.

A warming climate in Canada impacts water quantity and quality across the country. Frequent downpours in the Great Lakes could lead to localized flooding and overwhelm current sewage treatment facilities with increases in sewage and stormwater runoff.

The Prairies may see a decline in water levels on ponds, lakes and dugouts, leading to changes in water chemistry, which means less water for crop irrigation.

Health Impact

The health and well-being of Canadians could be affected by the climate change. Some of the health impacts are related to:

- an increasing number of smog and extreme heat events,
- the spread of infectious diseases from insects migrating northward, and
- a decline in the quality and the quantity of drinking water in some areas because of drought.

The health impact varies from one location to another and changes over time, as temperatures and other climatic conditions continue to change.

CONFIRMATION OF TEACHING POINT 1

QUESTIONS:

- Q1. How many regional climate zones are there in Canada?
- Q2. What are the health impacts related to the climate change in Canada?
- Q3. How does a changing climate impact health?

ANTICIPATED ANSWERS:

- A1. There are 11 regional climate zones in Canada.
- A2. The health impacts related to climate change in Canada are:
- an increasing number of smog and extreme heat events,
 - the spread of infectious diseases from insect migrating northward, and
 - a decline in the quality and the quantity of drinking water in some areas because of drought.
- A3. The health impact changes from one location to another and over time, as temperatures and other climatic conditions continue to change.

Teaching Point 2

Conduct a group discussion on seasonal concerns in a survival situation.

Time: 10 min

Method: Group Discussion

BACKGROUND KNOWLEDGE



The point of the group discussion is to draw the following information from the group using the tips for answering / facilitating discussion and the suggested questions provided.

There are four seasons in Canada: spring, summer, autumn and winter.

The following are typical features of seasons in the southern part of Canada:

Spring

The season starts in March and ends in May. During this period, the snow begins to melt. It is known to be the rainy season in most parts of Canada. The days become warmer, but the nights are still cool. Vegetation starts growing; however, trees remain bare until April or May.

Summer

The season starts in June and ends in August, though in some parts of Canada the season can last until mid-September. The temperatures in summer may reach 30 degrees Celsius or higher. The season is known to be typically hot and dry with occasional rainstorms / thunderstorms. Humidity is a factor around the Great Lakes region. This is the season of mosquitoes and blackflies.

Autumn

The season starts in September and ends in November with days becoming shorter. As the days become shorter, temperatures start to fall, and during the night, frost starts to appear. The vegetation starts to die off and leaves start to change colour. During this season, weather is unpredictable with rain and the first signs of snow usually appear in November.

Winter

The season starts in December and ends in February, sometimes later in some regions of Canada. This season is known for snow and ice. Snow can start as early as October and continue to late March. The temperatures are below zero degrees Celsius from December to mid-March, especially at night. The wind is a factor as well and wind chill can make it feel even colder. The only parts of Canada where temperatures appear to be milder are on the East and West Coasts, where there is more precipitation.

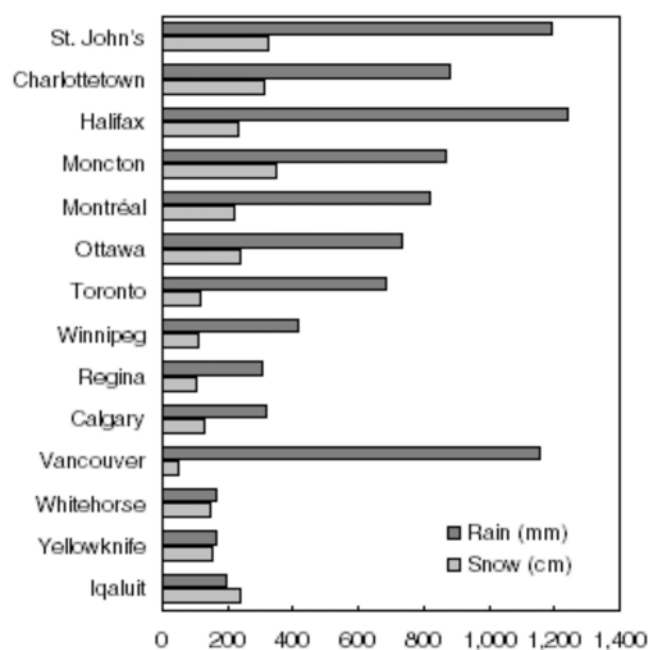

Figure 2 Annual Average Precipitation (1971 to 2000)

Note. From *Canadian Climate Normals*, by Environment Canada (2004). Retrieved April 22, 2009, from http://www.climate.weatheroffice.ec.gc.ca/climate_normals/index_e.html

GROUP DISCUSSION



TIPS FOR ANSWERING / FACILITATING DISCUSSION:

- Establish ground rules for discussion, eg, everyone should listen respectfully; don't interrupt; only one person speaks at a time; no one's ideas should be made fun of; you can disagree with ideas but not with the person; try to understand others as much as you hope they understand you; etc.
- Sit the group in a circle, making sure all cadets can be seen by everyone else.
- Ask questions that will provoke thought; in other words avoid questions with yes or no answers.
- Manage time by ensuring the cadets stay on topic.
- Listen and respond in a way that indicates you have heard and understood the cadet. This can be done by paraphrasing their ideas.
- Give the cadets time to respond to your questions.
- Ensure every cadet has an opportunity to participate. One option is to go around the group and have each cadet answer the question with a short answer. Cadets must also have the option to pass if they wish.
- Additional questions should be prepared ahead of time.

SUGGESTED QUESTIONS:

- Q1. How do the seasonal concerns in the spring affect an individual in a survival situation?
- Q2. How do the seasonal concerns in the summer affect an individual in a survival situation?
- Q3. How do the seasonal concerns in autumn affect an individual in a survival situation?
- Q4. How do the seasonal concerns in the winter affect an individual in a survival situation?



Other questions and answers will develop throughout the group discussion. The group discussion should not be limited to only those suggested.



Reinforce those answers given and comments made during the group discussion, ensuring the teaching point has been covered.

CONFIRMATION OF TEACHING POINT 2

The cadets' participation in the group discussion will serve as the confirmation of this TP.

END OF LESSON CONFIRMATION

The cadets' participation in the group discussion will serve as the confirmation of this lesson.

CONCLUSION

HOMEWORK / READING / PRACTICE

Nil.

METHOD OF EVALUATION

Nil.

CLOSING STATEMENT

It is important to describe climatic and seasonal concerns so you can apply the knowledge when in a survival situation.

INSTRUCTOR NOTES / REMARKS

Cadets who are qualified Survival Instructor may assist with this instruction.

REFERENCES

C3-341 Environment Canada.(2009). *Environmental impacts*. Retrieved April 16, 2009, from <http://www.ec.gc.ca/cc/default.asp?lang=En&n=4630D154-1>

C3-342 Environment Canada. (2009). *Health impacts*. Retrieved April 16, 2009, from <http://www.ec.gc.ca/cc/default.asp?lang=En&n=0B072979-1>

C3-343 O Canada. (2009). *Canadian regional climate*. Retrieved April 16, 2009, from <http://www.ocanada.ca/climate/regional.php>

C3-344 Government of Canada. (2008). *Four seasons*. Retrieved April 22, 2009, from <http://www.goingtocanada.gc.ca/CIC/display-afficher.do?id=000000000039&lang=eng>

THIS PAGE INTENTIONALLY LEFT BLANK



ROYAL CANADIAN AIR CADETS
PROFICIENCY LEVEL FOUR
INSTRUCTIONAL GUIDE



SECTION 7

EO C490.02 – IMPROVISE TOOLS FOR USE IN A SURVIVAL SITUATION

Total Time:	60 min
-------------	--------

PREPARATION

PRE-LESSON INSTRUCTIONS

Resources needed for the delivery of this lesson are listed in the lesson specification located in A-CR-CCP-804/PG-001, *Proficiency Level Four Qualification Standard and Plan*, Chapter 4. Specific uses for said resources are identified throughout the instructional guide within the TP for which they are required.

Review the lesson content and become familiar with the material prior to delivering the lesson.

The following examples of improvised tools should be constructed before this lesson:

- a knife,
- a needle,
- a compass, and
- a hammer.

PRE-LESSON ASSIGNMENT

Nil.

APPROACH

A group discussion was chosen for TP 1 to allow the cadets to interact with their peers and share knowledge and experiences about the potential of the materials at hand during a survival situation.

A demonstration and performance was chosen for TPs 2 and 3 as it allows the instructor to explain and demonstrate the skill of improvising tools while providing an opportunity for the cadets to practice the skill under supervision

A demonstration was chosen for TP 4 as it allows the cadets to observe how to construct a hammer.

INTRODUCTION

REVIEW

Nil.

OBJECTIVES

By the end of this lesson the cadet shall be expected to improvise tools for use in a survival situation.

IMPORTANCE

It is important for cadets to improvise tools for use in a survival situation as this skill enables the cadet to adapt to most survival situations. These skills give the survivor purpose and help build morale and spirit.

Teaching Point 1**Discuss the potential of the materials at hand for use in a survival situation.**

Time: 10 min

Method: Group Discussion

BACKGROUND KNOWLEDGE



The point of the group discussion is to draw the following information from the group using the tips for answering / facilitating discussion and the suggested questions provided.

A survival situation demands improvisation depending on what tools are available. Even simple tools can have multiple uses. If tools are not available, the surrounding area should be surveyed for possibilities.

Safety is paramount when using any tool or item as a tool. Injuries incurred during a survival situation deplete precious resources and energy and can be demoralizing to the survivor or survivors.

Using what is available should be one of the first things considered for all survival situations.

Usable items may be procured from the environment, vehicles, and buildings.

Vehicles, including cars, bicycles, trucks, heavy machinery, boats, snowmobiles and motorcycles offer some of the same items found on aircraft. Vehicles and buildings may be used as shelter.

Some suggested items that can be used from vehicles are:

- wires,
- mirrors,
- hubcaps,
- control cables,
- leatherette seat covers, and
- antennae.

Some suggested items that can be used from buildings are:

- wires,
- wood,
- glass,
- plastic, and
- various metal and plastic pipes and tubing.

Primitive man has survived in almost all environments on the planet. He has made use of the materials available.

Some suggested items that can be used from the surrounding environment are:

- trees,
- grasses and plants,
- stones,
- dirt,
- sand, and
- animal parts, to include:
 - fat,
 - skin,
 - organs,
 - bones, and
 - sinew.

GROUP DISCUSSION



TIPS FOR ANSWERING / FACILITATING DISCUSSION:

- Establish ground rules for discussion, eg, everyone should listen respectfully; don't interrupt; only one person speaks at a time; no one's ideas should be made fun of; you can disagree with ideas but not with the person; try to understand others as much as you hope they understand you; etc.
- Sit the group in a circle, making sure all cadets can be seen by everyone else.
- Ask questions that will provoke thought; in other words avoid questions with yes or no answers.
- Manage time by ensuring the cadets stay on topic.
- Listen and respond in a way that indicates you have heard and understood the cadet. This can be done by paraphrasing their ideas.
- Give the cadets time to respond to your questions.
- Ensure every cadet has an opportunity to participate. One option is to go around the group and have each cadet answer the question with a short answer. Cadets must also have the option to pass if they wish.
- Additional questions should be prepared ahead of time.

SUGGESTED QUESTIONS:

- Q1. Why is safety important when using tools in a survival situation?
- Q2. What are some items that can be taken from vehicles?

Q3. What are some items that can be taken from buildings?

Q4. What are some items that can be taken from the surrounding environment?



Other questions and answers will develop throughout the group discussion. The group discussion should not be limited to only those suggested.



Reinforce those answers given and comments made during the group discussion, ensuring the teaching point has been covered.

CONFIRMATION OF TEACHING POINT 1

The cadets' participation in the group discussion will serve as the confirmation of this TP.

Teaching Point 2

Explain, demonstrate and have the cadets construct a cutting or piercing tool.

Time: 15 min

Method: Demonstration and Performance



For this TP, it is recommended that instruction take the following format:

1. Explain and demonstrate the complete skill while cadets observe.
2. Explain and demonstrate each step required to complete the skill. Monitor cadets as they imitate each step.
3. Monitor the cadets' performance as they practice the complete skill.

Note: Assistant instructors may be employed to monitor the cadets' performance.

Cutting and piercing tools can make everyday life in a survival situation easier. They are used to prepare food, assemble shelter and create other tools.

Most purchased cutting and piercing tools are made of stainless or tool steel. Even if these materials are available, they are difficult to work without a forge, machine shop or special metal working tools. Therefore, softer materials like aluminum, bone or plastic should be considered.

A safety razor contains one or more thin blades. These are removed by disassembling the razor's head. Although small and thin, these blades are extremely sharp. The opposite edge should be covered with tape or mounted in wood.

Stone may be shaped into cutting tools, but the technique, called flint knapping, is difficult to master. The sharp edge of broken stones may be used as a cutting tool. Smashing two stones together may leave sharp fragments that will serve as a cutting tool. Use caution when breaking stones as sharp fragments will fly off the broken stone, potentially causing injury.

Broken glass can be used but is brittle and difficult to use without inflicting wounds on the user. A piece of broken glass has cutting edges on all sides. Covering the opposite edge of the tool with thick tape or in a grooved stick may prevent injury. Glass is very fragile and will not endure hard use as a cutting tool.

Bone, metal or plastic can be used to fashion cutting or piercing tools but the edge or point will not remain sharp. Adding small teeth to the edge of a cutting tool will help during cutting. Aluminum and other soft metal cutting edges can be formed by pounding the edge between two stones. The edge of a cutting tool and size of the blade should not exceed 10 cm. Longer edges become unwieldy in use.

Bone can be fashioned into a sewing needle. Strike the bone with a stone to create splinters. These splinters can be smoothed and shaped by rubbing on a stone. To pierce a hole for the eye of the needle, a sharp chip of stone can be set and bound in a split stick and spun between the hands to create a drill.

Handle material can be wood, with wire, strong material (seat cover, or leather) or cord wrapping. The handle should be comfortable in the hand and securely fastened to the blade.

When not being used, a protective cover can be fashioned from strong material to protect the knife and user.

CONFIRMATION OF TEACHING POINT 2

The cadets' construction of a cutting / piercing tool will serve as the confirmation of this TP.

Teaching Point 3

Explain, demonstrate and have the cadets construct a compass.

Time: 15 min

Method: Demonstration and Performance



For this skill lesson, it is recommended that instruction take the following format:

1. Explain and demonstrate the complete skill while cadets observe.
2. Explain and demonstrate each step required to complete the skill. Monitor cadets as they imitate each step.
3. Monitor the cadets' performance as they practice the complete skill.

Note: Assistant instructors may be employed to monitor the cadets' performance.

A compass needle points north because the needle is magnetized and becomes aligned by the earth's magnetic field. An improvised compass can be created from a small strip of ferrous metal and a container of water.

To magnetize the ferrous metal several methods may be employed. A sewing needle is an excellent piece of ferrous metal to magnetize as it is light in weight and easily magnetized.

Method 1:

Stroke a piece of silk fabric repeatedly in one direction (from the eye end to the point).

Method 2:

Stroke a magnet in one direction along the length of the needle (from the eye end to the point) repeatedly.

Method 3:

Heat the needle red hot and allow it to cool in an approximate north-south direction will. Use caution, as moving the red hot needle around to align it may prove difficult and dangerous in a survival situation.

Constructing the Compass

Once magnetized, the needle needs to be able to pivot freely to locate north.

There are several ways to allow the needle to pivot freely. One method is to float the needle on a liquid. If the needle floats on a liquid such as water it can rotate. A buoyant object (eg, cork, leaf, Styrofoam, plastic cling wrap, etc.) can be used to support the needle on the surface of the water. Surface tension supports a small needle, but any disturbance to the container and the needle will sink.

Another method of allowing the needle to rotate is to attach it to a fine string, cord, long strand of hair, fishing line or other fine cordage. The cordage is attached exactly in the middle of the needle to keep it horizontal. The needle points north when allowed to dangle at the bottom of the cordage. North is found by slowly turning the cordage left or right and observing when the needle is rotating the least. This method proves difficult in windy conditions.

To verify which end of the needle is pointing north, use basic navigational skills (eg, North Star, Sun's position during the day, etc.).

ACTIVITY

Time: 5 min

OBJECTIVE

The objective of this activity is to have the cadets a construct compass.

RESOURCES

- sewing needle,
- silk cloth, and
- small magnet.

ACTIVITY LAYOUT

Nil.

ACTIVITY INSTRUCTIONS

Have the cadets:

1. select a method of magnetizing the needle;
2. magnetize the needle;
3. select a method for allowing the needle to pivot;
4. determine north with the constructed compass; and
5. discuss the process of making a compass.



Cadets using the liquid method should improvise the float and container of water. Cadets using the cordage method should improvise the cordage.

SAFETY

Nil.

CONFIRMATION OF TEACHING POINT 3

The cadets' construction of an improvised compass will serve as the confirmation of this TP.

Teaching Point 4**Explain and demonstrate how to construct a hammer.**

Time: 10 min

Method: Demonstration



Using the hammer constructed prior to this lesson, explain and demonstrate how the hammer was made.

A hammer is one of the most basic and fundamental tools. It is perhaps the oldest human tool known. The earliest evidence of stone used as a hammer dates to about 2.4 million years ago. 30 000 years ago, humans adapted handles to stones to create hammers.

A stone can be used as a hammer for driving sticks into the ground, dispatching fish and small animals. If unhandled, the stone fits comfortably in the hand, with the finger tips extending just past the midpoint of the stone. Using smaller stones risks smashing fingers.

To make a split stick hammer, use the following steps:

1. Wrap the handle 15–20 cm from end with cordage.
2. Split the handle to the wrap.
3. Open tines and insert the stone hammer head.
4. Securely lash the stone to the handle.
5. Pull tines together at the top of the stone head and lash securely.

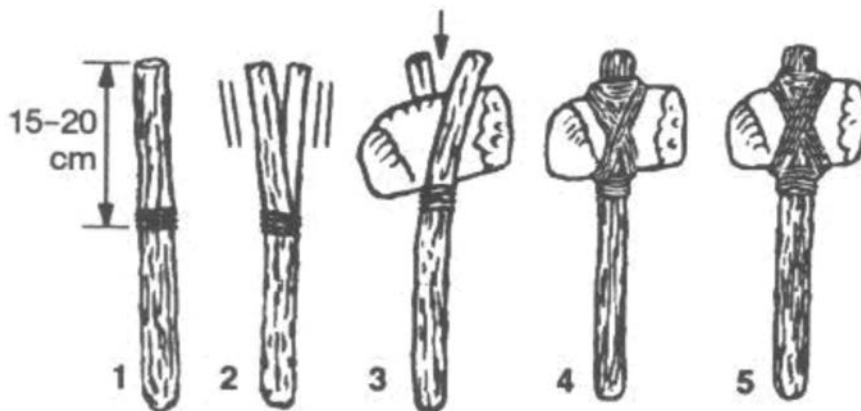

Figure 1 Split Stick Hammer

Note. From *U.S. Army Survival Handbook* (p. 134), by Department of the Army, 2002, Guilford, CT: The Lyons Press.

To make a forked stick hammer:

1. Find a suitable green wood forked branch and trim it to the correct length. Leave the tines long enough to be lashed above the stone.
2. Lash the base of the fork in the stick to prevent it from splitting when the tines are attached above the stone. A groove in the stone will help keep it from moving in use.
3. Set the stone in the crotch of the forked stick and start pulling the tines together with cordage. Secure the tines with cordage.

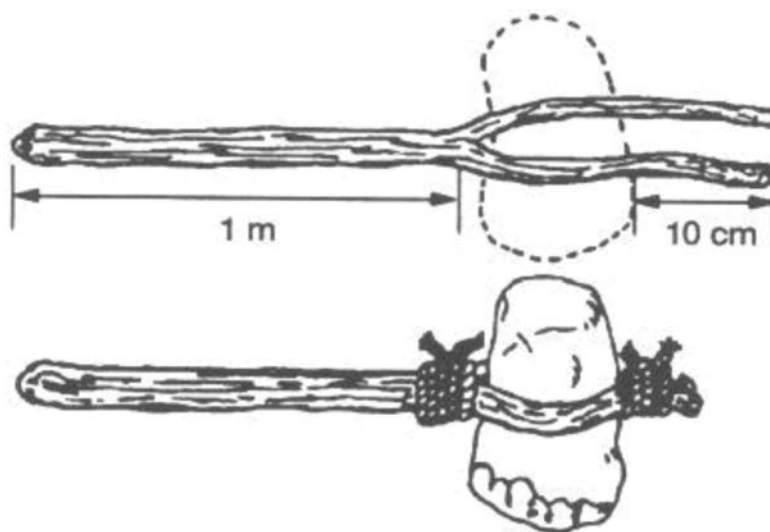

Figure 2 Forked Stick Hammer

Note. From *U.S. Army Survival Handbook* (p. 134), by Department of the Army, 2002, Guilford, CT: The Lyons Press.

To make a thinned stick hammer use the following steps:

1. Using a small stone, chip the hammer stone to create a shallow groove around its circumference for the wood to wrap.
2. Shave the end to half the diameter, long enough to wrap around the stone and meet the handle.
3. Wrap the wood around the stone head and lash securely.

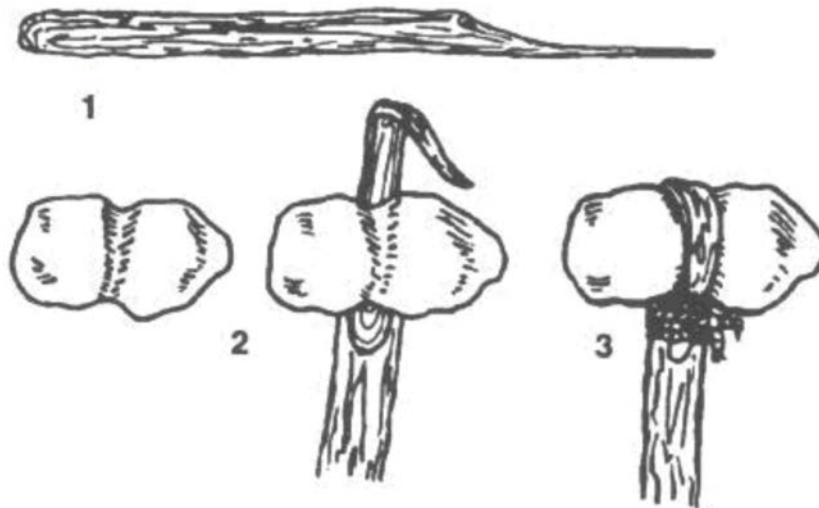

Figure 3 Thinned Stick Hammer

Note. From *U.S. Army Survival Handbook* (p. 134), by Department of the Army, 2002, Guilford, CT: The Lyons Press.

Wooden sticks can be attached to a stone to act as a handle. The handle increases the length of the swing radius, increasing the speed of the hammer head and the force delivered to the object being struck. It also keeps the user's hand away from the point of impact and reduces the shock of the blow to the user's hands. It is important to size the handle to the stone and the task. A handle that is too long results in an unwieldy tool and too short is inefficient.

The handle should be carefully constructed from green wood and attached securely to the stone. The diameter of the handle should be the same size as the user's index and middle finger combined. A split stick, Y-shape stick with the tines wrapped around or a stick thinned where it wraps around the stone will be more secure (as illustrated in Figures 1–3). The joint is strengthened by grooving the stone by chipping around its circumference, and lashing using a wet leather thong, wire, strong cordage or sinew for the binding.

Be conscious of the arc of the striking tool. If the stone separates from the handle, it has the potential to strike anything in that arc.

A piece of wood can also be used as a striking implement. The handle sizing remains the same as for a stone hammer. Larger diameter sections of log are reduced in the handle area to the proper handle size. This hammer or club is used either split or cut a piece of wood by hitting the back of the knife held in the opposite hand. This type of hammer or club does not last long in use as the objects being struck are usually wood, stone, or metal, which are harder than the club, causing it to splinter.

CONFIRMATION OF TEACHING POINT 4

QUESTIONS:

- Q1. What are some uses for a stone hammer?
- Q2. How should the stone be attached to the handle?
- Q3. Why will a wooden club not last long?

ANTICIPATED ANSWERS:

- A1. A stone can be used as a hammer for driving sticks into the ground, dispatching fish and small animals.
- A2. The stone should be attached to the handle by lashing using a wet leather thong, wire, strong cordage or sinew for the binding
- A3. A hammer or club will not last long in use as the objects being struck are usually wood, stone or metal which is harder than the club, causing it to splinter.

END OF LESSON CONFIRMATION

The cadets' improvisation of tools will serve as the confirmation of this lesson.

CONCLUSION

HOMEWORK / READING / PRACTICE

Nil.

METHOD OF EVALUATION

Nil.

CLOSING STATEMENT

The ability to improvise tools using found material can make the task of surviving easier. There will always be material in the area around the survivor. Identifying what they can be used for to assist in a survival situation is an asset.

INSTRUCTOR NOTES / REMARKS

Cadets who are qualified Survival Instructor may assist with this instruction.

REFERENCES

A3-016 B-GA-217-001/PT-001 Director Air Operations and Training. (1978). *Down but not out*. Ottawa, ON: Department of National Defence.

THIS PAGE INTENTIONALLY LEFT BLANK



**ROYAL CANADIAN AIR CADETS
PROFICIENCY LEVEL FOUR
INSTRUCTIONAL GUIDE**



SECTION 8

EO C490.03 – MOVE A CASUALTY TO SHELTER

Total Time:

90 min

PREPARATION

PRE-LESSON INSTRUCTIONS

Resources needed for the delivery of this lesson are listed in the lesson specification located in A-CR-CCP-804/PG-001, *Proficiency Level Four Qualification Standard and Plan*, Chapter 4. Specific uses for said resources are identified throughout the instructional guide within the TP for which they are required.

Review the lesson content and become familiar with the material prior to delivering the lesson.

There is no requirement for a qualified first aid instructor to teach the material contained in this lesson; however, the instructor should be a qualified first-aider.

Samples of improvised stretchers should be fabricated before conducting this lesson to use as examples.

PRE-LESSON ASSIGNMENT

Nil.

APPROACH

A practical activity was chosen for TP 1 as it is an interactive way to allow cadets to experience emergency scene management skills in a safe, controlled environment. This activity contributes to the development of first aid skills and knowledge in a fun and challenging setting.

A demonstration and performance was chosen for TPs 2 and 3 as it allows the instructor to explain and demonstrate moving a casualty to shelter and fabricating an improvised stretcher while providing an opportunity for the cadets to practice and develop these skills under supervision.

An interactive lecture was chosen for TP 4 to introduce the cadets to assessing the situation and caring for a casualty.

INTRODUCTION

REVIEW

Nil.

OBJECTIVES

By the end of this lesson the cadet shall have moved a casualty to shelter.

IMPORTANCE

It is important for the cadets to be able to perform first aid skills as injuries are a common occurrence in field settings. Having an understanding of moving a casualty to shelter, using proper carrying techniques and improvised stretchers, as well as, performing ongoing care will allow the cadets to take action in an emergency during a survival situation.

Teaching Point 1

Conduct an activity where the cadets will practice emergency scene management.

Time: 15 min

Method: Practical Activity



Qualified first-aiders must assist in the conduct of this TP.

EMERGENCY SCENE MANAGEMENT

Scene Survey

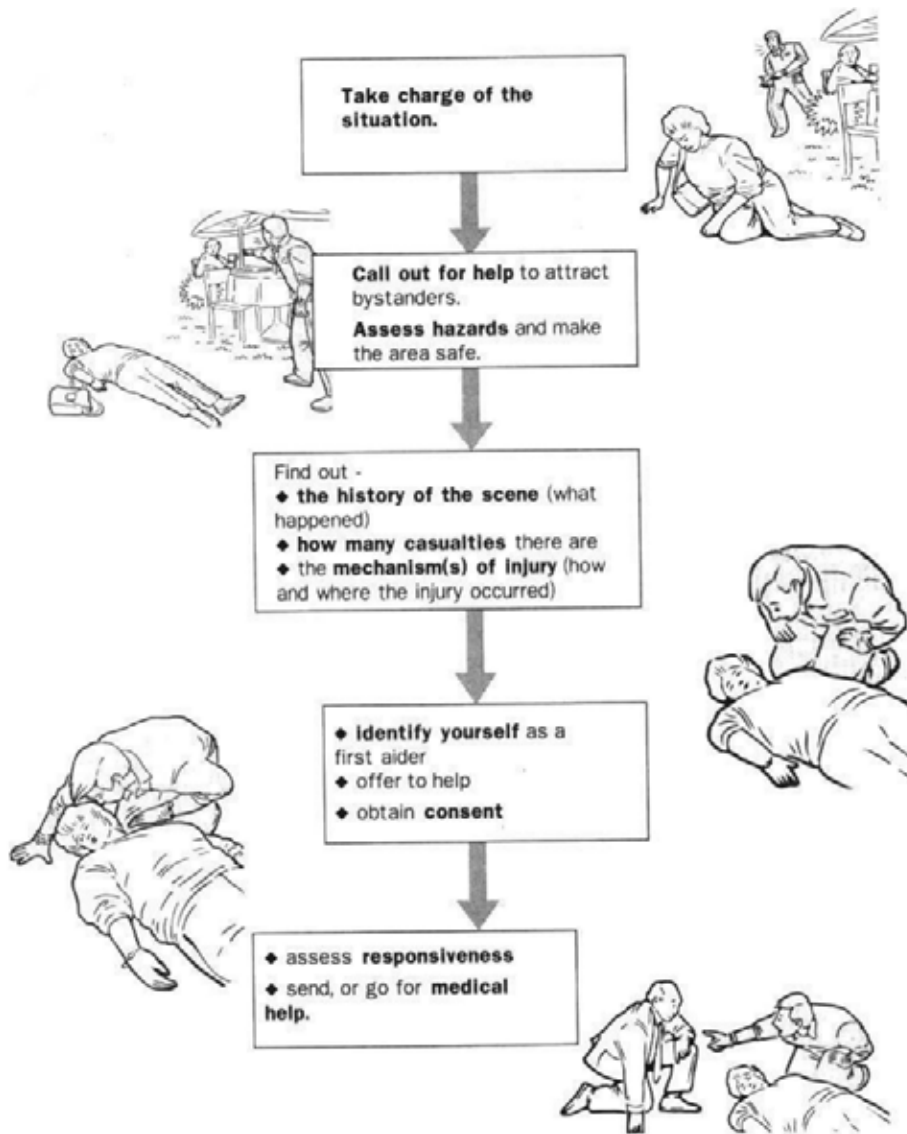

Figure 1 Scene Survey

Note. From *Military First Aid Safety Oriented Basic and Standard Levels Student Reference Guide* (p. 1-12), by St. John Ambulance, 2006, Ottawa, ON: National Defence Headquarters. Copyright 2006 by Priory of Canada of the Most Venerable Order of the Hospital of St. John Jerusalem.

Primary Survey

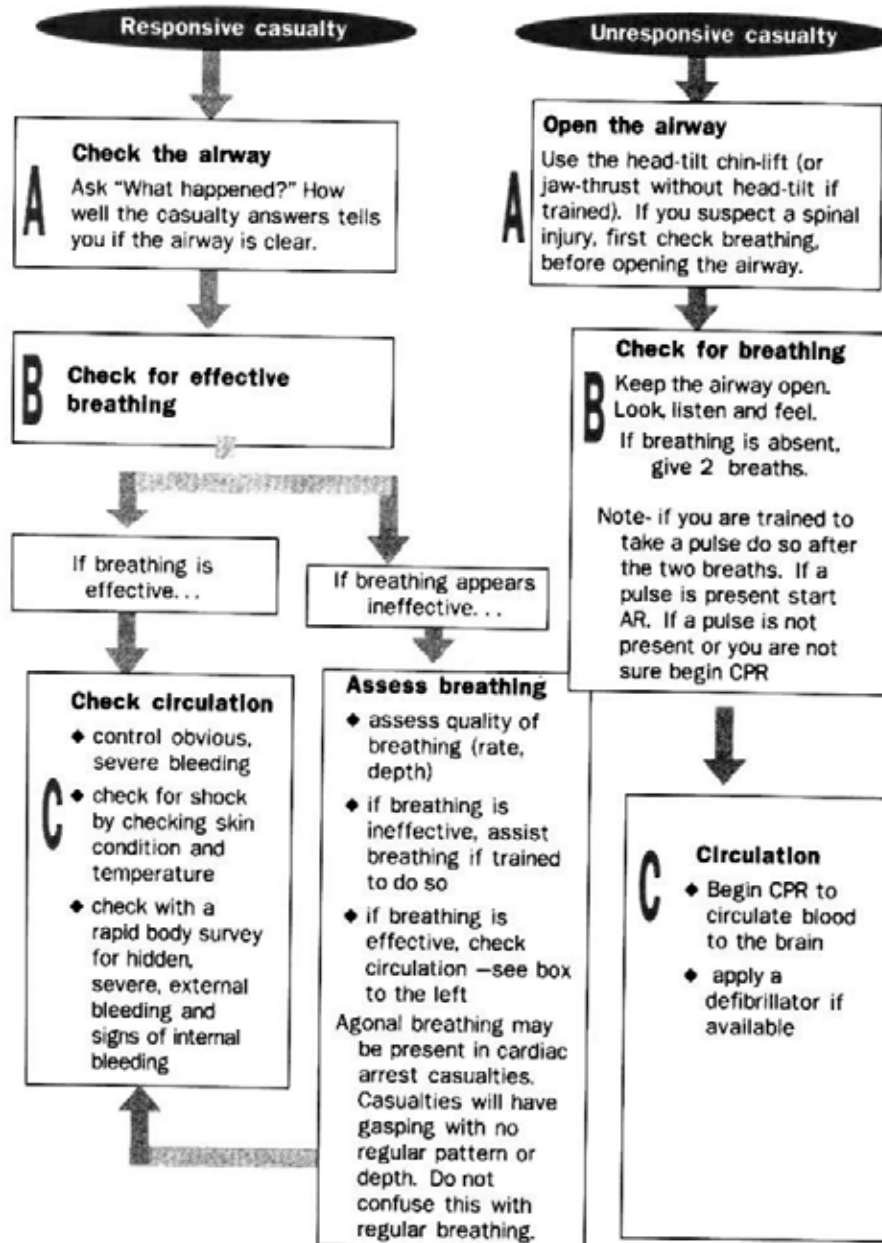

Figure 2 Primary Survey

Note. From *Military First Aid Safety Oriented Basic and Standard Levels Student Reference Guide* (p. 1-13), by St. John Ambulance, 2006, Ottawa, ON: National Defence Headquarters. Copyright 2006 by Priory of Canada of the Most Venerable Order of the Hospital of St. John Jerusalem.

Secondary Survey

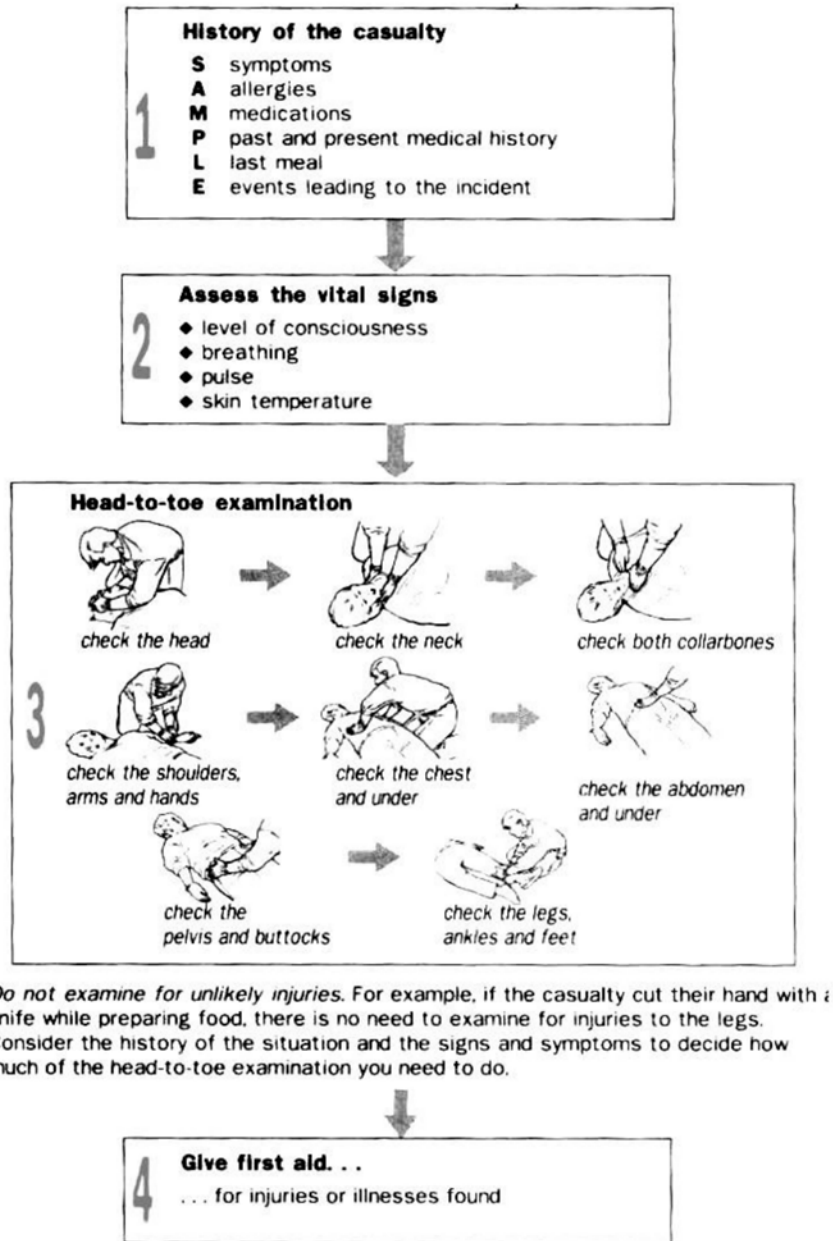

Figure 3 Secondary Survey

Note. From *Military First Aid Safety Oriented Basic and Standard Levels Student Reference Guide* (p. 1-14), by St. John Ambulance, 2006, Ottawa, ON: National Defence Headquarters. Copyright 2006 by Priority of Canada of the Most Venerable Order of the Hospital of St. John Jerusalem.

Ongoing Casualty Care

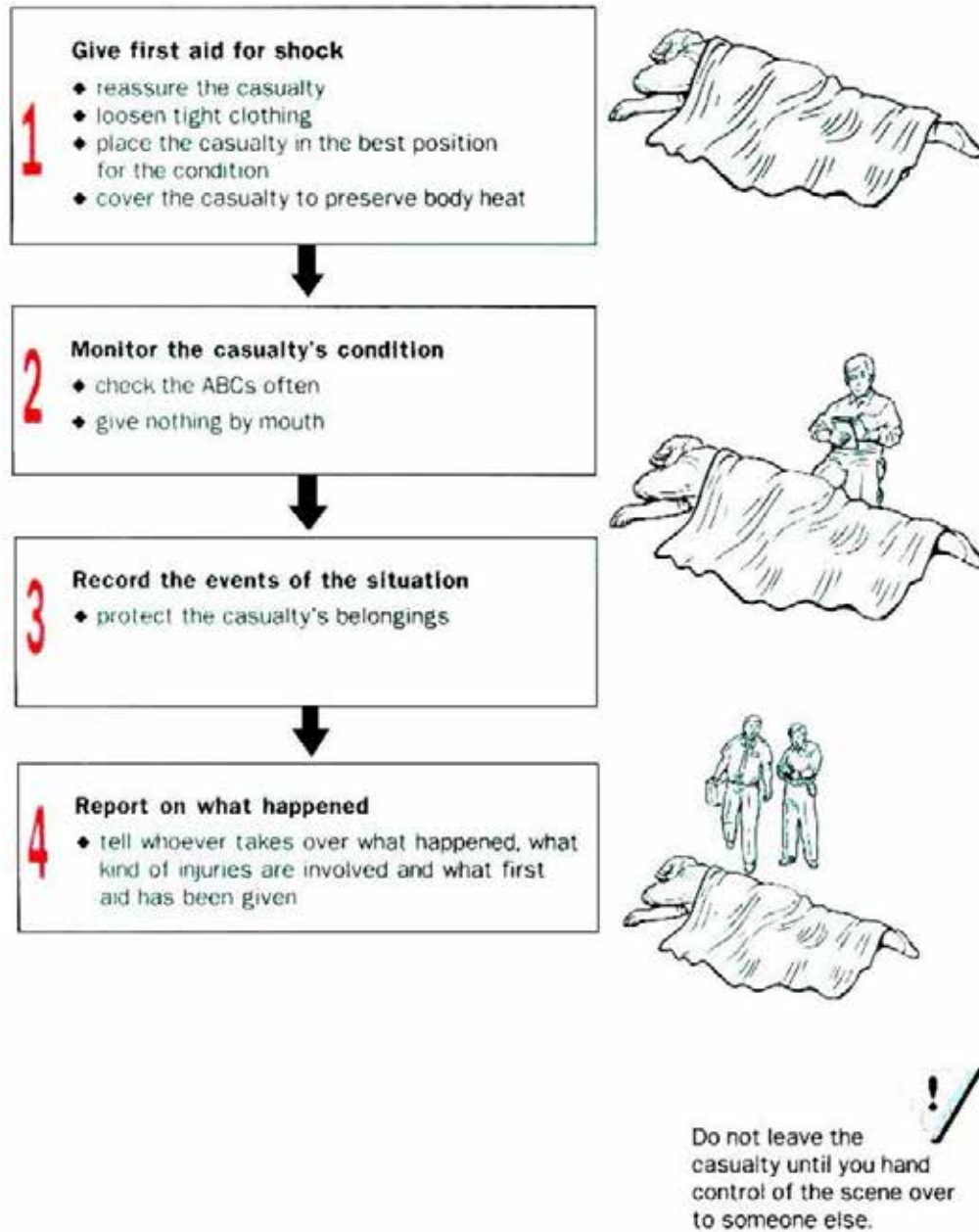

Figure 4 Ongoing Casualty Care

Note. From Military First Aid Safety Oriented Basic and Standard Levels Student Reference Guide (p. 1-15), by St. John Ambulance, 2006, Ottawa, ON: National Defence Headquarters. Copyright 2006 by Priory of Canada of the Most Venerable Order of the Hospital of St. John Jerusalem.

ACTIVITY

OBJECTIVE

The objective of this activity is to have the cadets review emergency scene management.

RESOURCES

Scenarios located at Attachment A.

ACTIVITY LAYOUT

Nil.

ACTIVITY INSTRUCTIONS

1. Divide the cadets into a group of three.
2. Assign a casualty, a first-aider and a bystander for each group.
3. Distribute a scenario to each group.
4. Have the cadets use the steps of emergency scene management to simulate providing first aid to the casualties.
5. Debrief the cadets on their performance during the scenario.



If time allows, cadets may change roles within the group.

SAFETY

Nil.

CONFIRMATION OF TEACHING POINT 1

The cadets' participation in the activity will serve as the confirmation of this TP.

Teaching Point 2

Explain, demonstrate and have the cadets, in pairs / groups of three, move a casualty to shelter.

Time: 20 min

Method: Demonstration and Performance



For this skill TP, it is recommended that the instruction take the following format:

1. Explain and demonstrate each carry while the cadets observe.
2. Explain and demonstrate each step required to complete the skill. Monitor the cadets as they imitate each step in pairs / groups of three.
3. Monitor the cadets' performance as they practice the complete skill.

Note: Assistant instructors may be used to assist with carries and monitor the cadets' performance.

MOVING AND CARRYING OVER SHORT DISTANCES

Many wilderness survival emergencies require moving or carrying a casualty a short distance, with usually only one or two rescuers. It is difficult to carry an adult for any distance and it is easy to injure them further while carrying. The following methods are used to minimize the chance of causing further injury while moving a casualty to shelter.

Drags

A casualty should be dragged only if they must be moved quickly out of danger, severe cold, strong winds, blowing snow or water. It is important to assess the casualty before attempting a drag because some injuries, if not yet stabilized, may be aggravated by premature movement. If there is only one rescuer, dragging may be the only means of moving a casualty.

When dragging a casualty, observe the following rules:

- Drag a casualty headfirst. This allows the head and neck to be supported and keeps the body straight.
- Keep the body in-line. The casualty's body must not twist or bend. Avoid major bumps.
- The neck should not bend sharply, nor should the head fall forward, back or to the side.

Steps to drag a casualty:

1. If possible, secure the casualty's hands before beginning the drag.
2. Reach under the casualty's body and grip their clothing just below their shoulder on either side while supporting the head and neck using the forearms.
3. Crouch or kneel and walk backwards (as illustrated in Figure 5).
4. Stop when the casualty is out of danger.



This drag is hard on the rescuer's back, so be careful.



Figure 5 Drag

Note. From *St. John Ambulance: The Official Wilderness First Aid Guide* (p. 21), by W. Merry, 1994, Toronto, ON: McClelland & Stewart Inc. Copyright 1997 by St. John Ambulance.

5. If the casualty's clothing pulls up too much or tears, place a shirt or jacket over their chest and bring the sleeves under their back to provide a firm grip (as illustrated in Figure 6).



The first-aider can use cuff buttons or Velcro, mitten ties or a piece of cord to assist in this drag.



Figure 6 Modified Drag

Note. From St. John Ambulance: The Official Wilderness First Aid Guide (p. 21), by W. Merry, 1994, Toronto, ON: McClelland & Stewart Inc. Copyright 1997 by St. John Ambulance.

Tarp Drag Method



Rarely should lifts or carries be done on snow because of the possibility of the rescuer slipping; it is safer and easier to drag a casualty on a tarp or sled.

The tarp drag method works well on snow. A rescuer may make a ramp of snow and slide a casualty onto a sled. This drag is also a good way to move a casualty onto insulating material to protect them from the cold ground or snow.

One may wish to leave the tarp under the casualty to aid in another lift. Always put the casualty into a basket stretcher with a backboard, blanket or tarp under them, as it is otherwise difficult to remove them without excessive movement.



Be careful when using the tarp drag method on sloping snow as control may be lost on a downhill slope.

Dragging a casualty on a tarp, blanket, sail, tent or large hide can be accomplished by following these steps:

1. Place the tarp next to the casualty.
2. Fold the tarp into accordion folds of about 1 m (3 feet) wide.
3. Log-roll the casualty by:
 - a. assigning a person to the head, torso, and foot of the casualty;
 - b. having the person at the head of the casualty control the roll and signal the start by counting to the three;
 - c. having the first-aiders roll the casualty towards the person who is at the torso;

- d. placing half of the tarp underneath the casualty while holding them securely on their side;
 - e. having the person at the head of the casualty count to three to signal the other first-aiders to roll the casualty back to their back.
4. Take the tarp that has been coiled underneath the casualty and pull it taut until the tarp is flat.



Figure 7 Rolling Onto a Tarp

Note. From *St. John Ambulance: The Official Wilderness First Aid Guide* (p. 21), by W. Merry, 1994, Toronto, ON: McClelland & Stewart Inc. Copyright 1997 by St. John Ambulance.

5. Grip the tarp and hold the casualty's head and shoulders off the ground and drag carefully.



Figure 8 Tarp Drag

Note. From *St. John Ambulance: The Official Wilderness First Aid Guide* (p. 21), by W. Merry, 1994, Toronto, ON: McClelland & Stewart Inc. Copyright 1997 by St. John Ambulance.

Single-Rescue Carries

Most single-rescue carries are for short distances and cannot be used to transport a casualty with major injuries. All are extremely strenuous. They are often used to transport casualties with injuries of the lower extremities but care must be taken as it is easy to cause further injuries.

Packstrap Carry

This is a quick, easy carry for very short distances. The casualty must be able to stand to get into position with their arms across the shoulders like packstraps. Bring the casualty's arms across the shoulders, crossing their wrists in front. Hold their wrists while bending forward and lift the casualty's feet off the ground. Be sure their arms are bent at the elbow.



Figure 9 Packstrap Carry

Note. From *St. John Ambulance: The Official Wilderness First Aid Guide* (p. 23), by W. Merry, 1994, Toronto, ON: McClelland & Stewart Inc. Copyright 1997 by St. John Ambulance.

Piggyback Carry

This familiar carry is good for short-distance transport of conscious casualties with minor injuries and may be used to carry children for long distances.



Figure 10 Piggyback Carry

Note. From *St. John Ambulance: The Official Wilderness First Aid Guide* (p. 23), by W. Merry, 1994, Toronto, ON: McClelland & Stewart Inc. Copyright 1997 by St. John Ambulance.

Carrying Seat

A quick and easy backpack seat to assist the piggyback system may be made with a simple loop of wide strap. It may be necessary to adjust the length once or twice for maximum comfort. This seat is best used if the casualty is lighter than the rescuer, otherwise it may put pressure on the rescuer's neck and shoulders.



Figure 11 Carrying Seat With Wide Strap

Note. From *St. John Ambulance: The Official Wilderness First Aid Guide* (p. 23), by W. Merry, 1994, Toronto, ON: McClelland & Stewart Inc. Copyright 1997 by St. John Ambulance.

CARRYING OVER LONG DISTANCES USING TWO-PERSON CARRIES

Lifting is half as strenuous if there are two rescuers; however carrying for any distance is usually not easier because two carriers must compensate for each other's movements to keep balanced. The chance of error is multiplied with each added person in a lifting team and injury to the casualty often occurs if lifts are poor. Whenever more than one person lifts, observe the following rules:

- One person must be clearly designated as the leader and be responsible for giving all of the commands.
- The partner(s) must be told exactly what is to be done and what the commands will be.
- The lift should first be practiced without the casualty or on an uninjured person.
- Rescuers should maintain eye contact while lifting.

The Fore-and-Aft Lift and Carry

This should be used only if the casualty has minor injuries. On uneven terrain, it may be the easiest method of lifting a casualty onto a stretcher or another means of transport. As it produces some pressure against the chest, it will restrict the casualty's air flow. Follow these steps:

1. If the casualty is conscious, help them sit up. If the casualty is unconscious, have a partner take the casualty's hands and pull them into the sitting position.

2. Cross the casualty's arms on their chest.
3. Crouch behind them, reach under their arms and grasp the casualty's wrist.
4. Have your partner crouch between the casualty's knees, facing the casualty's feet and take a leg under each arm.
5. At the leader's signal, rise, keeping your back straight.



Figure 12 Fore-and-Aft Lift and Carry

Note. From *St. John Ambulance: The Official Wilderness First Aid Guide* (p. 26), by W. Merry, 1994, Toronto, ON: McClelland & Stewart Inc. Copyright 1997 by St. John Ambulance.

Two-Hand Seat

This two-person lift and carry is good for casualties who cannot hold onto the rescuer's shoulders for support, or who are not fully alert.

1. Rescuers crouch on either side of the casualty.
2. Each rescuer will slide one hand under the casualty's thighs and lock fingers over a pad or while wearing mittens or gloves so that fingernails do not dig into each other (as illustrated in Figure 13).

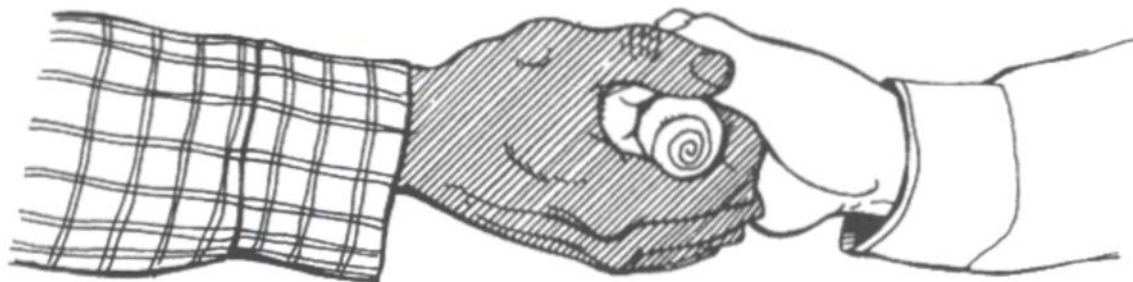

Figure 13 Hand Grip

Note. From *St. John Ambulance: The Official Wilderness First Aid Guide* (p. 26), by W. Merry, 1994, Toronto, ON: McClelland & Stewart Inc. Copyright 1997 by St. John Ambulance.

3. Reach across the casualty's back and grip their belt and pants at the opposite hip; the rescuers' arms are crossed (as illustrated in Figure 14).
4. At the leader's signal, raise and step off with the inside foot. This supports the casualty's back; however, the fingers of the gripping hands will tire quickly.



Figure 14 Two-Person Lift

Note. From *St. John Ambulance: The Official Wilderness First Aid Guide* (p. 26), by W. Merry, 1994, Toronto, ON: McClelland & Stewart Inc. Copyright 1997 by St. John Ambulance.

For longer carries, try gripping your partner's wrists rather than their fingers. If wearing mittens, gripping the wrist will be more secure than gripping the hand. If the casualty is unconscious, they may be lifted easily to a sitting position. One rescuer pulls on the casualty's hands while the other lifts and supports their head; then the rescuers move into position while supporting the casualty's head and back.



Figure 15 Two-Person Carry

Note. From St. John Ambulance: The Official Wilderness First Aid Guide (p. 26), by W. Merry, 1994, Toronto, ON: McClelland & Stewart Inc. Copyright 1997 by St. John Ambulance.

CONFIRMATION OF TEACHING POINT 2

The cadets' performing the rescue carries will serve as the confirmation of this TP.

Teaching Point 3

Explain, demonstrate and have the cadets, as members of a group, fabricate an improvised stretcher.

Time: 30 min

Method: Demonstration and Performance

FABRICATE AN IMPROVISED STRETCHER

If a person is injured and the situation requires that the casualty be moved, an improvised stretcher may be required. When fabricating an improvised stretcher, follow these steps:

1. **Inventory the available resources.** What materials are available to fabricate a stretcher? Any materials may be used, from natural resources to parts of a downed aircraft. Roots to wiring may be used as cordage and wooden poles to a section of a wing of an aircraft as the frame. Materials that make the casualty comfortable; from spruce boughs to blankets. Examine everything that may be of use.
2. **Fabricate the improvised stretcher.** Once the materials have been gathered, they need to be fabricated into the stretcher. Care should be made to ensure both the strength of the stretcher and the comfort of the casualty.
3. **Test the durability of the stretcher before use.** Before placing the casualty on the stretcher, it should be tested to ensure it is both strong and comfortable. If the stretcher comes apart, dropping the casualty,

it may make a bad situation worse. If the stretcher is not comfortable, it may cause further injury or make the casualty move around, trying to get comfortable, making the stretcher more difficult to carry.



For this skill TP, it is recommended that instruction take the following format:

1. Explain and demonstrate each type of improvised stretcher while the cadets observe.
2. Explain and demonstrate each step required to complete the skill. Monitor the cadets as they imitate each step in groups.
3. Monitor the cadets' performance as they practice the complete skill.

Note: Assistant instructors may be used to assist with fabricating of the improvised stretchers and to monitor the cadets' performance.

EXAMPLES OF IMPROVISED STRETCHERS

Pole Stretcher

A very stable stretcher, but the casualty may need to be secured to prevent their sliding off.

RESOURCES

- Two poles approximately 3 m long,
- 10–12 sticks approximately 60 cm long,
- Cordage, and
- Blanket.

ACTIVITY INSTRUCTIONS

1. Lay the two long poles approximately 50 cm apart.
2. Using the cordage, tie the short sticks across the gap to create a bed approximately 2 m long.
3. Lay the blanket over the stretcher.
4. Test the stretcher by having one cadet at the head and one cadet at the foot of a volunteer, standing between the poles, using their legs (not their backs), in unison, lift the volunteer.

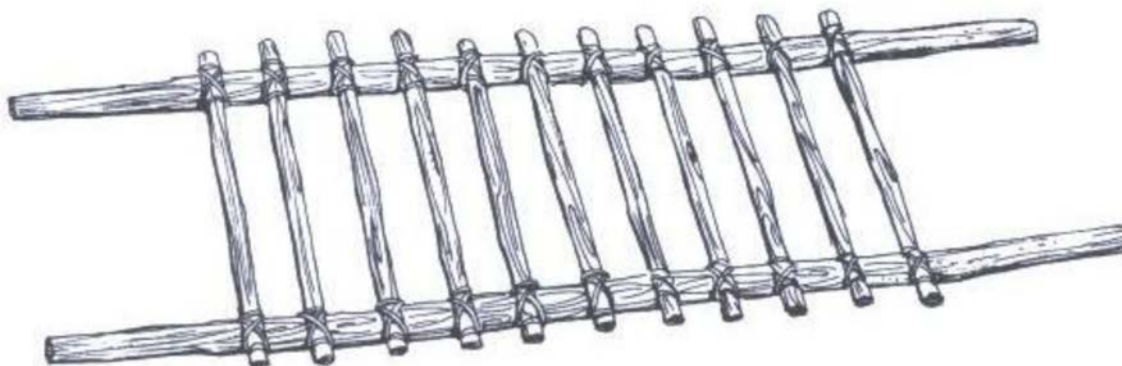

Figure 16 Pole Stretcher

Note. From *St. John Ambulance: The Official Wilderness First Aid Guide* (p. 31), by W. Merry, 1994, Toronto, ON: McClelland & Stewart Inc. Copyright 1997 by St. John Ambulance.

Rolled Pole Stretcher

Easy to fabricate and requires minimal resources. However, there is a possibility of the casualty being compressed within the stretcher, which may cause further injury.

RESOURCES

- Two poles approximately 3 m long, and
- One tarp.

ACTIVITY INSTRUCTIONS

1. Lay the casualty on the centre of the tarp.
2. Roll each pole into the tarp, one on each side, parallel to the casualty (see Figure 17).
3. Test the stretcher by having one cadet at the head and one cadet at the foot of a volunteer, standing between the poles, using their legs (not their backs), in unison, lift the volunteer.



Figure 17 Rolled Pole Stretcher

Note. From *St. John Ambulance: The Official Wilderness First Aid Guide* (p. 29), by W. Merry, 1994, Toronto, ON: McClelland & Stewart Inc. Copyright 1997 by St. John Ambulance.

Shirt Stretcher

Easy to fabricate and requires minimal resources. However, there is a possibility of the casualty being compressed within the stretcher, which may cause further injury. There is also the possibility of the casualty falling between a gap between two shirts.

RESOURCES

- Two poles approximately 3 m long, and
- Two to four shirts.

ACTIVITY INSTRUCTIONS

1. Insert the poles into the sleeves and bodies of the shirts to create a bed approximately 2 m long. Ensure that any fasteners (eg, buttons, zippers) are fastened.
2. Test the stretcher by having one cadet at the head and one cadet at the foot of a volunteer, standing between the poles, using their legs (not their backs), in unison, lift the volunteer.

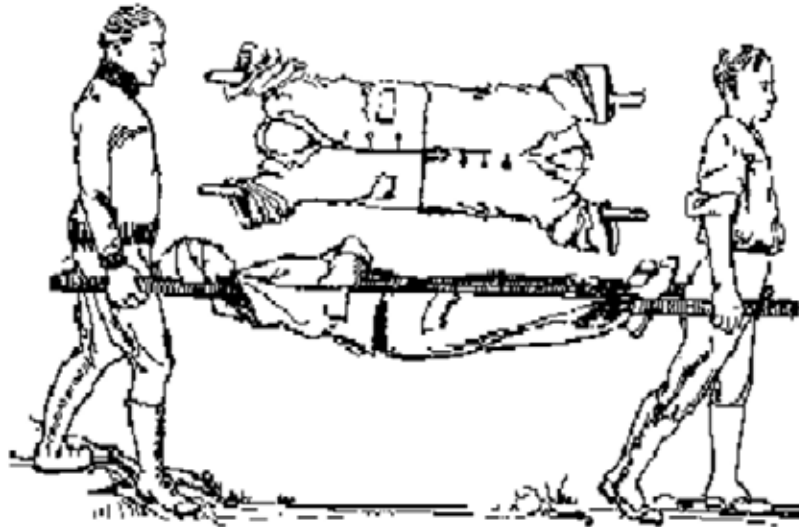

Figure 18 Shirt Stretcher

Note. From "Soil and Health Library", by S. Solomon, 2007, *First Aid in Accidents*. Retrieved March 17, 2009, from <http://www.soilandhealth.org/02/0201hyglibcat/020146.lindlahr.nat.therap/Nat.Thera.Pt5.htm>

CONFIRMATION OF TEACHING POINT 3

The cadets' fabricating improvised stretchers will serve as the confirmation of this TP.

Teaching Point 4

Time: 15 min

Discuss casualty care.

Method: Interactive Lecture

DISCUSS CASUALTY CARE

In a survival situation, there may be a long time between administering first aid and getting the casualty to medical help. The first-aider is required to administer ongoing casualty care until rescued / found. The first-aider should focus on the following:

Breathing

When someone is inactive deep breaths are rarely, if ever, taken. Shallow breathing may allow fluids and mucus to build up in the lungs. This promotes the growth of bacteria and for the possibility of the casualty catching pneumonia. It is important for the casualty to take deep breaths and to cough, even if it hurts. If the injury permits, place the casualty in a semi-sitting position to make it easier to take deeper breaths / cough. Semi-sitting also makes it easier for the casualty to hold their sides, which may make taking deeper breaths / coughing less painful.

Warmth

The body, when injured, uses energy to try to heal itself. This results in less energy to maintain body heat which means an injured person can take twice as long to replace lost body heat.



Never assume that because you are warm, a casualty is also warm.

It is easier to cool a person down than to warm them up, therefore it is better to keep a casualty warm. Keep the casualty dry, if possible wearing layers or in a sleeping bag. Put extra padding / insulation between the casualty's body and the ground. Care must be taken when using clothing that does not breathe as condensation will form from the casualty's body as this will make the inner layers damp, however, it should be used to protect from the rain and the wind.

Rocks warmed by the fire and wrapped in cloth will act as a portable heater; however, ensure that the rock is not as hot as to burn. If the casualty is unconscious, check the casualty often and move / replace the heated rock as required.

Body's Position

Body position may have a profound effect on the casualty. Often, a casualty may want to get into a different position. If the injury is not affected, allow the casualty to get into their own comfortable position. Certain positions will produce specific results, as follows:

- **Recovery position.** This position should be used if the casualty is unconscious, or not fully alert.
- **Semi-sitting position.** This position makes it easier for the casualty to breathe as it reduces the pressure of the abdomen on the lungs.
- **Knees raised position.** This position reduces tension on the chest and abdomen making injuries there less painful.
- **Shock position (on the back with legs slightly raised).** This position is used if the casualty is in shock or faint.
- **Elevation of injured arms / legs.** These positions will help reduce swelling / bleeding to the injured limb.
- **Most comfortable position.** Sometimes it may be necessary to place a casualty into a position that they find to be the most comfortable.

If a casualty maintains the same position for several days, watch out for bedsores. If bedsores develop, treated them the same as an infected wound and do not place the casualty back into the same position. This will only aggravate the treated bedsores.

Morale

Reassurance is important during every moment of a casualty's care. As in a survival situation, fear greatly reduces a person's will to survive. A survival situation combined with an injury multiplies the effect of fear. Ways to maintain a casualty's morale include:

- Staying cheerful and optimistic even if personally discouraged.
- Reassuring the casualty often.
- Always explaining to the casualty what is being done to them.
- Touching the casualty often in an appropriate, comforting and companionable way. Warm human contact is a major part of reassurance.
- Not discussing the casualty's condition in their hearing unless it is optimistic.
- Involving the casualty in their own care by encouraging them to do as much as possible for themselves.
- Keeping the casualty informed of / part of any plans. For example, if someone is leaving the survival site to gather berries, tell the casualty so they do not worry about the possibility that they are being abandoned.

Rest

Rest promotes healing, reduces tendencies to bleed or swell, and often reduces pain and stress. Sometimes, pain will prevent adequate rest. If pain medications are available and are used as prescribed, they will help the casualty to rest.

Fluid Intake

Maintaining fluid levels is very important, especially for an injured person. Fluids should not be given to a person with internal injuries or who is vomiting. Unfortunately, dehydration over a day or two may cause more damage than small amounts of fluids, even when they are not recommended in normal first aid practice. The following should be considered:

- Give no fluids if the casualty is unconscious, feels nauseated or is vomiting, or has abdominal injuries.
- Give only small amounts at first until it can be determined whether the casualty will vomit or not. Always be ready for vomiting.
- Give small amounts often rather than lots at once. If the casualty can barely swallow, give sips every five or ten minutes.
- If possible, give nutritious fluids. However, do not give alcohol, coffee, tea, hot chocolate or any drinks with caffeine as these are diuretics which increase urine output and increase the possibility of dehydration.
- Give water to any shock, burn or dehydration casualty who can tolerate it.
- Maintain liquid intake of at least five to six litres / day. If there are signs of dehydration, encourage the casualty to drink more.

Urination

A person normally urinates about one litre per day. If there is less than expected, suspect shock / dehydration. If the urine is bloody, discoloured, or has a strong smell, record this information. If the casualty's injury prevents them from urinating on their own, improvise a bedpan / urinal. Always try to maintain the casualty's dignity.

RECORDING ALL OBSERVATIONS

It is very important to record all observations, including the date and time. Also record what was done (eg, first aid provided, what drunk / eaten, symptoms, vital signs, bowel movements, urination) and when. Be alert to changes as these are signs of changes in the casualty's condition. This information may be of assistance to the medical personnel who will be taking over the care for the casualty.

CONFIRMATION OF TEACHING POINT 4**QUESTIONS:**

- Q1. Describe three (of the five) body positions discussed.
- Q2. What is the importance of rest?
- Q3. Why should all observations be recorded?

ANTICIPATED ANSWERS:

A1. The six positions discussed:

- **Recovery position.** This position should be used if the casualty is unconscious, not fully alert, or is nauseated and may vomit.
- **Semi-sitting position.** This position makes it easier for the casualty to breathe as it reduces the pressure of the abdomen on the lungs.
- **Knees raised position.** This position reduces tension on the chest and abdomen making injuries there less painful.
- **Shock position (on the back with legs slightly raised).** This position is used if the casualty is in shock or faint. However, if there are breathing problems or a chest / abdominal injury, make sure just the legs, and not the whole body, is raised to reduce pressure on the abdomen / lungs.
- **Elevation of injured arms / legs.** These positions will help reduce swelling / bleeding to the injured limb.
- **Most comfortable position.** Sometimes it may be necessary to place a casualty into a position that they find to be the most comfortable.

A2. Rest promotes healing, reduces tendencies to bleed or swell, and often reduces pain and stress.

A3. Alerts the caregiver to changes as these may be signs of changes in the casualty's condition. This information may be of assistance to the medical personnel who will be taking over the care for the casualty.

END OF LESSON CONFIRMATION

The cadets' moving a casualty to shelter will serve as the confirmation of this lesson.

CONCLUSION

HOMEWORK / READING / PRACTICE

Nil.

METHOD OF EVALUATION

Nil.

CLOSING STATEMENT

It is important for the cadets to be able to perform first aid skills as injuries are a common occurrence in field settings. Having an understanding of moving a casualty to shelter, using proper carrying techniques and improvised stretchers, as well as, performing ongoing casualty care will allow the cadets to take action in an emergency during a survival situation.

INSTRUCTOR NOTES / REMARKS

Cadets who are qualified Survival Instructor or qualified first-aiders in Proficiency Level Four may assist in the conduct of this EO.

The assessment of the casualty in order to move the casualty will be conducted by the qualified first-aider.

Samples of improvised stretchers should be fabricated before conducting this lesson to use as examples.

REFERENCES

A0-134 A-MD-050-072/PW-001 Canadian Forces (2006). *Military first aid: Safety oriented: Basic and standard levels: Activity book*. Ottawa: Department of National Defence.

C2-030 ISBN 0-7710-8250-9 Merry, W. (1994). *St. John Ambulance: The official wilderness first aid guide*. Toronto, ON: McClelland & Stewart Inc.

THIS PAGE INTENTIONALLY LEFT BLANK

EMERGENCY SCENE MANAGEMENT SCENARIOS

Scenario 1

A shopper has fallen while slipping on the wet floor and hits his/her head and is unconscious. There is one employee trained in first aid and another shopper is willing to assist until medical help arrives.

Scenario 2

A spectator in an arena falls down a set of stairs. You are a St. John Ambulance volunteer who must respond and perform Emergency Scene Management for the casualty who has suspected head / spinal injuries.

Scenario 3

Three first year cadets are inside of a modular tent during a thunderstorm. The first cadet is leaning against the pole and lightning strikes the tent. The first cadet receives burns to his back. The second cadet is trained in first aid and the third cadet will assist with the casualty until officers and medical help arrives.

Scenario 4

A cadet is using a knife to cut a piece of wood, while the cadet is doing this, another cadet close by bumps into the cadet. The cadet has cut their hand.. A few cadets are in the general area and hear the screams of the two cadets. One of them is trained in first-aid and assists until medical help arrives.

THIS PAGE INTENTIONALLY LEFT BLANK



ROYAL CANADIAN AIR CADETS
PROFICIENCY LEVEL FOUR
INSTRUCTIONAL GUIDE



SECTION 9

EO C490.04 – PRACTICE SAFE TOOLCRAFT

Total Time:	90 min
-------------	--------

PREPARATION

PRE-LESSON INSTRUCTIONS

Resources needed for the delivery of this lesson are listed in the lesson specification located in A-CR-CCP-804/PG-001, *Proficiency Level Four Qualification Standard and Plan*, Chapter 4. Specific uses for said resources are identified throughout the instructional guide within the TP for which they are required.

Review the lesson content and become familiar with the material prior to delivering the lesson.

PRE-LESSON ASSIGNMENT

Nil.

APPROACH

A demonstration and performance was chosen for this lesson as it allows the instructor to explain and demonstrate the skills. The cadets are expected to sharpen a knife and an axe, and to cut wood while providing an opportunity for the cadets to practice the skills under supervision.

INTRODUCTION

REVIEW

Nil.

OBJECTIVES

By the end of this lesson the cadet shall be expected to practice safe toolcraft.

IMPORTANCE

It is important for the cadets to be able to safely use tools on an aircrew survival exercise. Tools support aircrew survival training by assisting the cadets in setting up an aircrew survival exercise site, erecting tents and starting fires. The cadets need to know how to safely use tools to prevent accidents.

Teaching Point 1**Explain, demonstrate and have the cadets handle, pass and store tools.**

Time: 25 min

Method: Demonstration and Performance

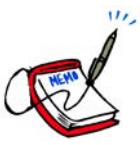

For this skill lesson it is recommended that the instruction take the following format:

1. Explain and demonstrate handling, passing and storing tools while the cadets observe.
2. Explain and demonstrate each step required to complete each skill. Monitor the cadets as they imitate each step.
3. Monitor the cadets' performance as they practice the complete skill.

Note: Assistant instructors may be used to monitor the cadets' performance.

HANDLING TOOLS

All tools need to be handled with great care and control. For this lesson, focus on the safe handling and passing of a knife, an axe and a bow saw, since these tools are most dangerous when used incorrectly.

These safety considerations should transfer to all other tools that are used during an aircrew survival training exercise.

Axe

A blade cover protects the user from injury, the cutting edge from damage and should be used if available. Always carry an axe by its head. Place two fingers on one side, and grip the neck with the other fingers and thumb on the other side. The handle should point horizontally to the ground and the blade should face outward.



Figure 1 Axe

Note. Created by Director Cadets 3, 2009 Ottawa, ON: Department of National Defence.

Bow Saw

A bow saw has a sharp long blade that should be covered when carrying for long distances. When the bow saw is carried short distances, the carrier should be aware of where the blade is at all times. Keep the blade facing away from the body and hold the handle firmly. It can be carried in hand, with the blade facing down.



Figure 2 Bow Saw

Note. Created by Director Cadets 3, 2009 Ottawa, ON: Department of National Defence.

Shovel

The shovel is to be handled at the upper part of the shaft toward the shoulder when carrying. The shovel blade should be facing the ground with the cutting edge pointing downward.



Figure 3 Spade Shovel

Note. Created by Director Cadets 3, 2009 Ottawa, ON: Department of National Defence.

Knives



Using a knife improperly can cause injuries and damage the knife. It is important to remember what the knife is designed to do. It is not designed to pry. This may damage the tip of the blade. The handle or butt is not a hammer.

A dull knife requires more energy to use and increases the risk of injury.

A knife can assist greatly during a survival situation but it is useless if it is broken by using it as a substitute for another tool.

When handling a knife, practice the following principles:

- Always cut away from the body or limbs, never toward.
- If the knife is dropped, let it fall to the ground as trying to catch it may cause serious injury.
- Never point a knife at anybody.
- If the knife is a fixed blade, always return it to the sheath when not in use.
- If the knife is of the folding variety, keep it folded away when not in use or keep it in a sheath.
- Never walk or run around with an open or unsheathed knife.

Ensure the knife is only used when the user can clearly see what they are doing. Use adequate lighting after dark.



Figure 4 Survival Knife

Note. From "Military Pictures", *Gerber Infantry Survival Knife*, Retrieved April 28, 2009, from <http://www.militarypictures.info/weapons/gerber.jpg.html>

PASSING TOOLS

When passing tools that have a sharp edge, adhere to the following steps:

1. The passer communicates the intent to pass the tool.
2. The receiver gives both a verbal response and eye contact that they accept.
3. The passer and the receiver stand facing each other.
4. The passer holds out the tool with both hands and the sharp edge down.
5. The passer waits for the recipient to place both hands on the tool.
6. The passer asks the recipient if they have control.
7. The recipient states that they have control.
8. The passer releases control of the tool.



These steps may seem overstated, but most accidents that occur when passing tools are a result of poor communication. It takes very little force for a sharp tool to severely injure.

STORING TOOLS

When storing tools, adhere to the following:

- Always clean tools before storing.
- Check tools frequently to ensure they are in operating condition.
- Always choose a tree close to the aircrew survival site to store tools or build a tool shelter.
- Store tools in a common area that is clearly identifiable.
- Mask or store axes and bow saws in a secure case when not in use (as illustrated in Figure 6)
- Keep all tools away from rain, snow and dirt.
- Do not leave an axe or a bow saw embedded in a stump as the sap causes the blade or bit to rust.
- Do not leave tools lying on the ground.
- Tools should not be stored against a tree even for a brief time.
- The user is responsible for the tool from the time it is taken from its case or storage area until it is returned.



Figure 5 Tool Rack

Note. From *Scoutmaster, Knots and Pioneering*, Copyright 2007 by Amazon.com, Inc. Retrieved November 18, 2007, from http://scoutmaster.typepad.com/.shared/image.html?/photos/uncategorized/chip5_copy_copy.jpg

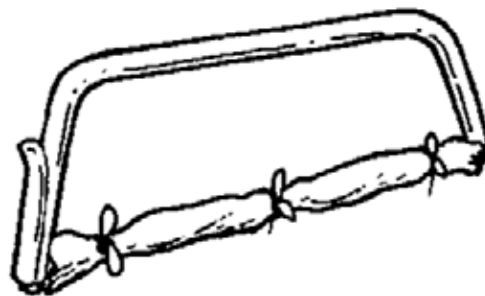

Figure 6 Storing a Bow Saw

Note From "Use of Axes and Saws", Copyright 2005 by ScoutBase UK. Retrieved April 28, 2009, from <http://www.scoutbase.org.uk/library/hqdocs/facts/pdfs/fs315070.pdf>

CONFIRMATION OF TEACHING POINT 1

The cadets' participation in handling an axe, a bow saw, a shovel and a knife, and safely passing and storing tools will serve as the confirmation of this TP.

Teaching Point 2**Explain, demonstrate and have the cadets clean and sharpen a knife and file and sharpen an axe.**

Time: 20 min

Method: Demonstration and Performance



For this skill lesson it is recommended that the instruction take the following format:

1. Explain and demonstrate cleaning and sharpening a knife and an axe while the cadets observe.
2. Explain and demonstrate each step required to complete the skill. Monitor the cadets as they imitate each step.
3. Monitor the cadets' performance as they practice the complete skill.

Note: Assistant instructors may be used to monitor the cadets' performance.

KNIVES

To preserve the life of a knife, only use it for its intended purpose. Do not to use blades to pry things, punch holes, as a hammer, or as a screwdriver.

Cleaning

To clean a folding knife, open the blade and rinse with warm soapy water and dry well. It may be helpful to scrub it with an old toothbrush. Be careful when handling the knife while the blade is open.

When the knife is completely dry, lightly oil it with machine oil (or cooking oil if the knife is used for food). Wipe off any excess oil and close the blades.

It is important to keep the edge of a knife blade sharp, as a dull knife can be more dangerous than a sharp one. Do not exert too much pressure or use force to make a blade cut through something. By keeping the knife clean, dry and lightly oiled, it will not require sharpening as often.

When sharpening a knife it is important to keep it secure, maintain a uniform sharpening angle on both sides and be careful of cutting fingers. A sharpening stone is most practical for sharpening a knife.

Sharpening Using a Sharpening Stone and a Honing Stone

Sharpen a knife as soon as it becomes dull. Use a quality sharpening stone and apply lubricant as specified for the stone. To reshape an edge use a 400 grit sharpening stone. A 1 000 grit sharpening stone and above will sharpen the edge. A honing stone is used to polish the cutting edge and is usually above 2 000 grit. To polish a blade that has stains on it, use wood ash as it will not scratch the blade. Use the following steps when sharpening a knife with a sharpening stone:

1. Apply a light coating of oil (if it is a whetstone or oil stone) to the stone to lubricate and protect the surface. The oil helps keep bits of stone and steel—called slurry—on the surface of the stone. The slurry helps the cutting action of the stone. Ceramic and diamond stones can be used dry or wetted with water.
2. If a combination stone is being used, start with the coarsest grit side.



A hollow ground blade will be sharpened only at the cutting edge at a combined angle 20–30 degrees.

3. To sharpen a hollow ground blade hold the knife with the back edge of the knife off the sharpening stone at 10–15 degrees.
4. To sharpen a flat ground blade, place the bevel flat on the stone. This will register the blade at the proper angle for sharpening.
5. Start where the blade meets the handle and draw the full length of the blade across the stone while moving the blade from one end of the stone to the other. Apply steady pressure. Repeat this eight times on each side.
6. Repeat the process using the fine side of the sharpening stone.
7. Using a honing stone and honing oil, hone the blade, alternate each stroke with the opposite side of the blade for eight strokes maintaining the same angle as before.
8. If a wire edge forms—a thin wire of steel at the very edge of the blade—repeat the same motion on a piece of card board or honing stone until the wire edge falls off.
9. Test for sharpness by cutting something or by looking at the edge of the blade for reflections from unsharpened areas, not by drawing the fingers across the blade.
10. Clean and dry the stone following the manufacturers' instructions.

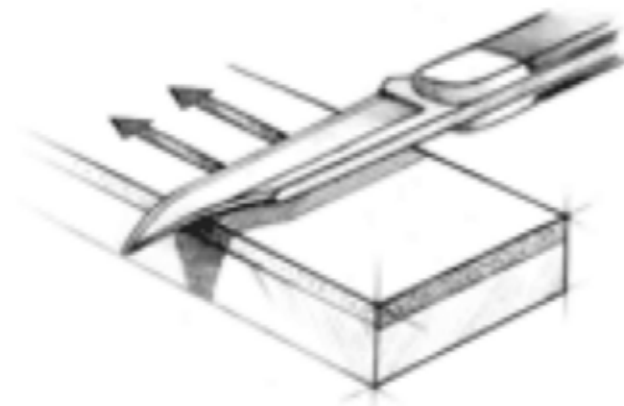

Figure 7 A Sharpening Stone

Note. From *Chesapeakeknifeandcutlery.com*, Copyright 2007 by PAX River Enterprises. Retrieved November 19, 2007, from <http://www.chesapeakeknifeandcutlery.com/index.asp?PageAction=Custom&ID=49>

AXES

If the axe's cutting edge is chipped or misshaped from repeated honing, filing will be necessary. If the edge has the proper profile but is dull, honing is all that is required.

Filing an Axe Head

Placing the axe in a vice or clamp it securely to a work surface. Facing the axe head, hold the handle of the file with the right hand and the tip of the file with the left hand. Reverse if left handed. Thick leather gloves are

recommended for this procedure. File towards the edge at a 10-degree angle, moving from the top of the blade to the bottom. The file must bite only in the push movement and not to touch the axe when returning to the start position. Only remove enough material to shape the cutting edge. Once a side is done then turn the blade over in the vice and repeat the process.



Figure 8 Filing an Axe

Note. From “U.S. Department of Transportation Federal Highway Administration”, 2004, *An Axe to Grind: A Practical Ax Manual*,

Sharpening Using a Sharpening Stone and Honing Stone

With the axe in the vice, sharpen the edge using a sharpening stone. Use a circular motion starting from the top of the blade to the bottom. Make sure the stone remains in contact with the blade at the proper angle of 20 degrees. Finish sharpening with a honing stone and honing oil to polish the edge, using the same circular motion as with the sharpening stone.



The best way to keep an axe sharp is to use and store it properly. Do not stick it in the dirt or leave it in a tree. Always clean it after each use and apply oil to the blade. Always keep the original shape of the bit and the bevel. An axe that is given the wrong shape and bevel can bounce off the wood uncontrolled.

CONFIRMATION OF TEACHING POINT 2

The cadets' cleaning and sharpening of a knife and filing and sharpening an axe will serve as confirmation of this TP.

Teaching Point 3**Explain, demonstrate and have the cadets cut wood.**

Time: 20 min

Method: Demonstration and Performance



For this skill lesson, it is recommended that instruction take the following format:

1. Explain and demonstrate how to cut wood using tools skill while cadets observe.
2. Explain and demonstrate each step required to complete the skill. Monitor cadets as they imitate each step.
3. Monitor the cadets' performance as they practice the complete skill.

Note: Assistant instructors may be employed to monitor the cadets' performance.

SAFE WOOD CUTTING

An axe and a saw can be dangerous tools if mishandled. If the tools are in a poor condition—either dull, rusted or damaged—they should not be used. Using cutting tools requires proper attitude and concentration. Avoid using tools when tired or angry. Always be conscious of where the blade is.

Clothing

Avoid loose clothing, scarves or anything that may become entangled with the tool. Thick leather boots with steel toes are recommended.

Site

The site should be clear of ground obstructions and people. Overhanging branches should be trimmed away from the cutting site. Ensure all people know that wood is being cut and that they stay 10 m back. An axe held at arms length will indicate the minimum area that should be cleared for chopping. Cordon off the area used for chopping.

Inspect the axe before use. Do not use an axe if the head and handle do not line up straight, if the handle is split, chipped or otherwise damaged or broken, or if the head is loose. Never use a blunt axe as it can slip or bounce off wood uncontrolled.

Splitting Wood

Always use a chopping block below the wood to be chopped and do not let the axe go into the ground. The chopping block should be the largest round available and placed upright so the top surface is level and parallel to the ground.

Chop directly over the chopping block. The part to be cut should be resting at the centre of the chopping block and standing on its own.

Always stop when feeling tired, because there is a greater chance of missing and causing a serious injury.

Use an axe within a marked out chopping area. A bow saw is a safer tool to use away from the chopping area.

The chopping area is out of bounds for anyone not properly clothed or trained.

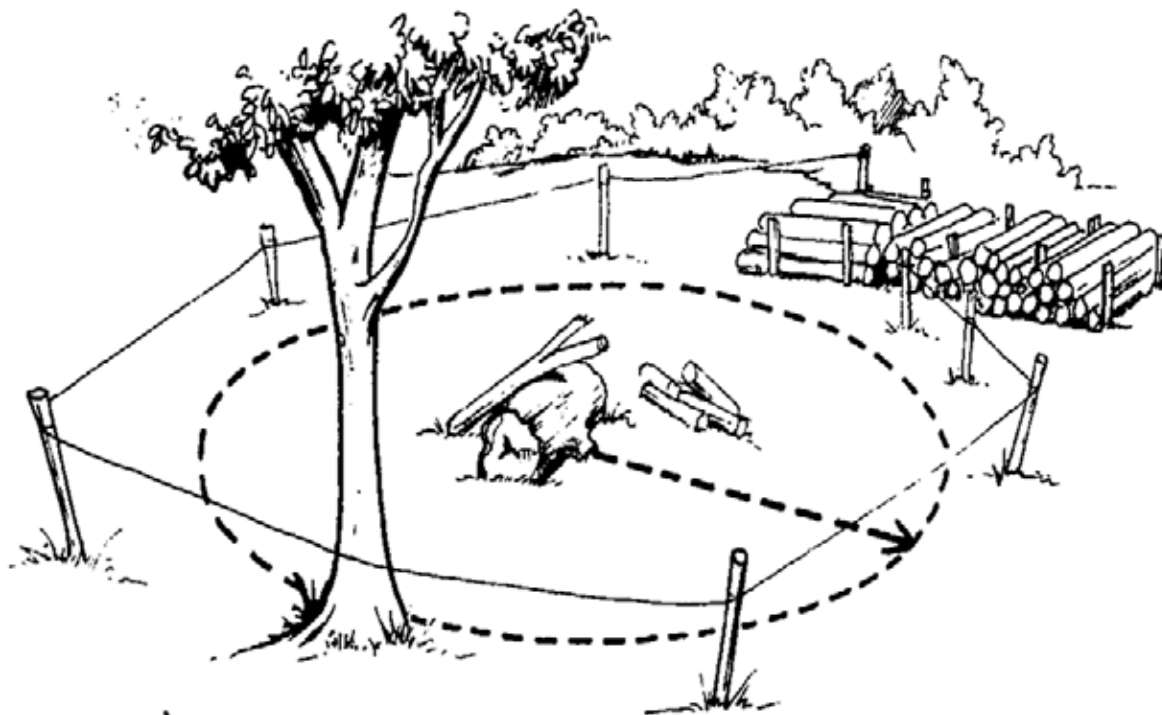

Figure 9 Chopping Area

Note. From [Scoutingresources.org/camping](http://www.scoutingresources.org/camping), Copyright 2007 by Scouting Resources.
Retrieved November 19, 2007, from http://www.scoutingresources.org.uk/camping_axe.html

USING AN AXE

On a Chopping Block



Before starting to use an axe, ensure that there is no one in the chopping area.

To chop wood with an axe:

1. Place a round of wood on the chopping block on its widest end, aligning the round so no knots face the person chopping.
2. Stand facing the chopping, legs spread shoulder width apart, the axe head centred on the chopping block at arms length.
3. Raise the axe above the head and bring it down onto the round. Let the momentum of the swing and weight of the axe do the work. To verify the distance from the block is correct, check the swing by chopping into the chopping block. Adjust the position as necessary.



To split larger logs, use a wedge and a mallet (as illustrated in Figure 15).

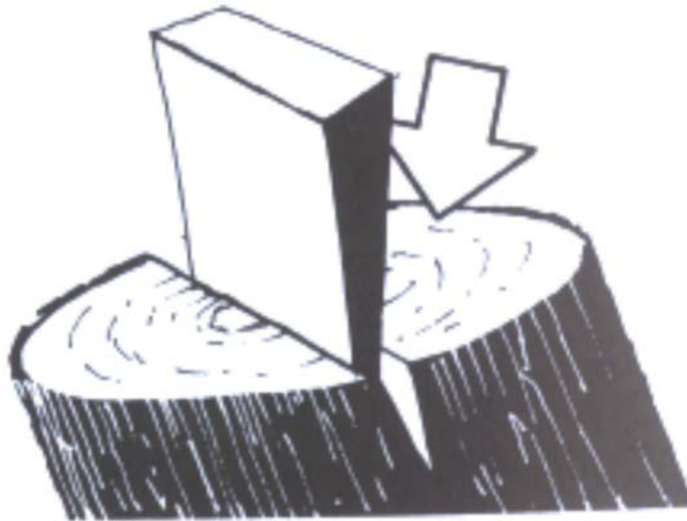

Figure 10 Wedge

Note. From *The SAS Survival Handbook* (p. 306), by J. Wiseman, 1999, Hammersmith, London: HarperCollins Publishers. Copyright 1986 by John Wiseman.

Cutting Logs



Before starting to use an axe, ensure that there is no one in the work area.

To remove branches, chop on the outside of the fork (as illustrated in Figure 11). Make sure to stand on the other side of the log to prevent injury (as illustrated in Figure 12). Always cut towards the tip of the tree.

To chop a log into shorter pieces, stand facing the log, feet wider than shoulder width, axe in hand, arm and axe length from the log. If is too close to the log, the axe head may pass over the log causing the axe handle to strike the log and break. If the person cutting the log is too far from the log, the axe head may strike the ground. Start the cut by striking the log a few times at a 45 degree angle left of the center of the cut. Create a V shape as wide as the log is round. Repeat this on the right side of the center of the cut. Alternate blows to either side of the cut. When possible, cut past the half way point, roll the log over and continue chopping from that side. The final blows should be done with caution as hitting the ground with the axe will dull it immediately.



Figure 11 Removing Branches 1

Note. From *The SAS Survival Handbook* (p. 306), by J. Wiseman, 1999, Hammersmith, London: HarperCollins Publishers. Copyright 1986 by John Wiseman.

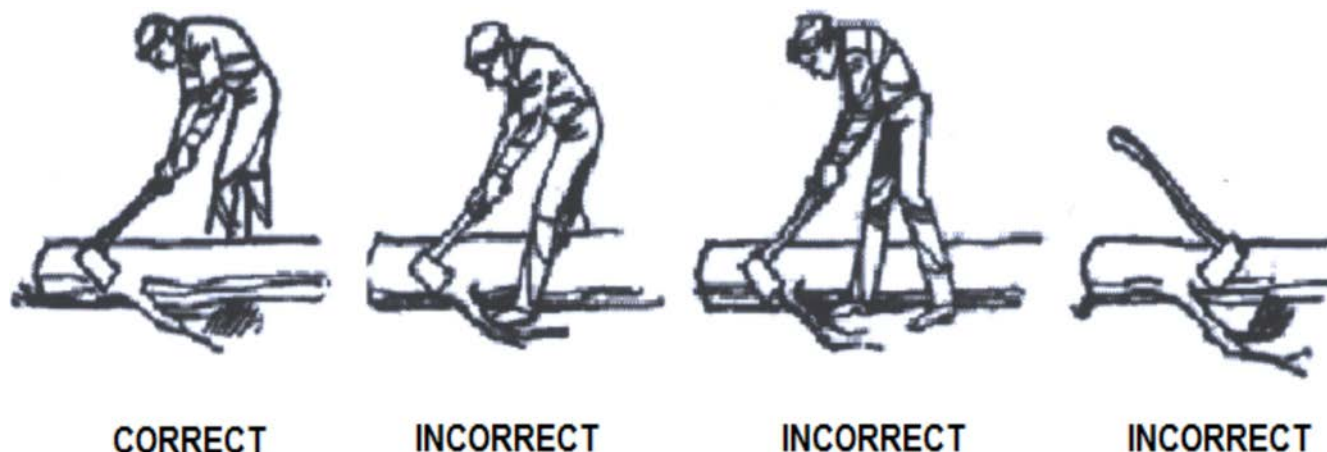

Figure 12 Removing Branches 2

Note. From [Scoutingresources.org/camping](http://www.scoutingresources.org/camping), Copyright 2007 by Scouting Resources. Retrieved November 19, 2007, from http://www.scoutingresources.org.uk/camping_axe.html



Figure 13 Log Chopping 1

Note. From *The SAS Survival Handbook* (p. 306), by J. Wiseman, 1999, Hammersmith, London: HarperCollins Publishers. Copyright 1986 by John Wiseman.

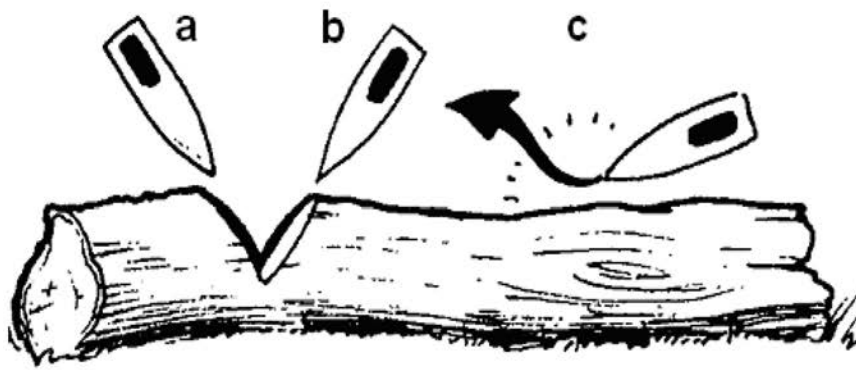

a. First few chops at 45 degrees.

b. Opposite angle chops at 45 degrees.

c. Wrong angle resulting in the axe bouncing off the wood.

Figure 14 Log Chopping 2

Note. From scoutingresources.org/camping, Copyright 2007 by Scouting Resources. Retrieved November 19, 2007, from http://www.scoutingresources.org.uk/camping_axe.html



Always look at the place the axe will hit. When practicing it is a good idea to put a chalk mark on the log and try to hit it.

After each swing make sure to look around and check for people close by.

Clear chippings away regularly and use them for kindling.

USING A BOW SAW



Before beginning, ensure that there is no one in the immediate area.

A bow saw is an efficient wood cutting tool when used properly. The wood being sawn must be supported so it cannot move. The saw should be held by one hand at the handle just above the blade. The other hand is placed at the top of the bow. The hand holding the handle supplies the power to the stroke. The upper hand guides the saw without applying any downward pressure.

To start the cut, place the saw blade where the wood is to be cut and pull the saw backward. At first it may be difficult to push and pull the blade as very few teeth are in contact with the wood causing the teeth to dig in. As the saw cuts deeper, it will be easier to push and pull as more teeth become supported by the wood. Avoid pushing down on the bow as this will cause the teeth to dig deep into the wood stopping the saw. Maintain rhythm while pushing and pulling. The teeth of the saw blade are set, meaning each tooth is alternately bent to the left or right of the blade. This removes chips wider than the blade preventing the saw from sticking in the wood. Ease up and slow down near the end of the cut.

The diameter of the piece of wood being cut should be less than half the length of the blade. This will allow the wood chips to be pushed clear the kerf (the width of the cut).

Avoid using one hand to hold the wood while sawing with the other. The wood being cut can be held down by a helper.



Always cover the blade of the saw after each use by using either a plastic 'clip-on' mask or tie a length of canvas around the blade.

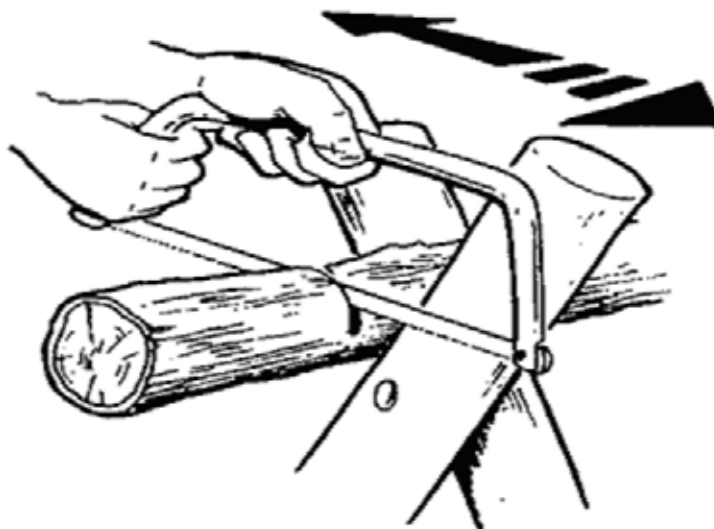

Figure 15 Cutting With a Bow Saw

Note. From scoutingresources.org/camping, Copyright 2007 by Scouting Resources. Retrieved November 19, 2007, from http://www.scoutingresources.org.uk/camping_axe.html

CONFIRMATION OF TEACHING POINT 3

The cadets' using an axe and a bow saw to cut wood will serve as the confirmation of this TP.

Teaching Point 4

Explain, demonstrate and have the cadets use a shovel.

Time: 15 min

Method: Demonstration and Performance



For this skill lesson, it is recommended that instruction take the following format:

1. Explain and demonstrate the complete skill while cadets observe.
2. Explain and demonstrate each step required to complete the skill. Monitor cadets as they imitate each step.
3. Monitor the cadets' performance as they practice the complete skill.

Note: Assistant instructors may be employed to monitor the cadets' performance.

Ensure that the area where the hole will be dug is marked. Areas with roots and rocks should be avoided.

DIGGING A HOLE

Place the tip of the shovel on top of the ground. The blade of the shovel should be vertical before digging into the ground. Place one foot on top of the shovel blade and while pushing down, rock the shovel from side to side. Once the blade of the shovel is in the ground pull back 45 degrees to free the soil. If the shovel will not pull back, reposition it around the hole. With one hand midway down the shovel shaft and the other at the top

using the leg muscles, lift the soil from the hole. Place the soil in a pile close to the hole. Continue to dig the hole until it is 30 cm deep into the ground.

FILLING THE HOLE

Holes that are no longer needed should be filled in. To fill the hole, push the blade of the shovel into the soil and then lift the soil into the hole. Repeat until the hole is filled. Pack the soil down to make the soil even with the rest of the earth. Sod should be replaced and the area groomed to remove all signs of the hole.

CONFIRMATION OF TEACHING POINT 4

The cadets' participation in using a shovel to dig a hole and to fill a hole will serve as the confirmation of this TP.

END OF LESSON CONFIRMATION

The cadets' practicing of safe toolcraft will serve as the confirmation of this lesson.

CONCLUSION

HOMEWORK / READING / PRACTICE

Nil.

METHOD OF EVALUATION

Nil.

CLOSING STATEMENT

It is important for the cadets to be able to use tools on an aircrew survival exercise. Tools support aircrew survival training by assisting in setting up a field exercise, erecting tents, starting fires. The cadets need to know how to safely use and care for tools to prevent accidents.

INSTRUCTOR NOTES / REMARKS

Sharpening should only be done under close supervision of trained staff members, to prevent unnecessary damage to the equipment and injury to cadets.

Cadets who are qualified Survival Instructor may assist with this instruction.

REFERENCES

C3-002 ISBN 0-00-653140-7 Wiseman, J. (1999). *The SAS survival handbook*. Hammersmith, London: HarperCollins Publishers.

C3-003 ISBN 1-896713-00-9 Tawrell, P. (1996). *Camping and wilderness survival: The ultimate outdoors book*. Green Valley, ON: Falcon Distribution.



ROYAL CANADIAN AIR CADETS
PROFICIENCY LEVEL FOUR
INSTRUCTIONAL GUIDE



SECTION 10

EO C490.05 – NAVIGATE A ROUTE USING A MAP AND COMPASS

Total Time:	120 min
-------------	---------

PREPARATION

PRE-LESSON INSTRUCTIONS

Resources needed for the delivery of this lesson are listed in the lesson specification located in A-CR-CCP-804/PG-001, *Proficiency Level Four Qualification Standard and Plan*, Chapter 4. Specific uses for said resources are identified throughout the instructional guide within the TP for which they are required.

Review the lesson content and become familiar with the material prior to delivering the lesson.

Learning stations are a form of group work, where the cadets will be learning by demonstration and performance. When setting up learning stations, ensure that there is enough room for each cadet to be comfortable, and adequate space to work with the equipment. When cadets arrive at a learning station, all materials shall be available. These stations should be placed closely together to minimize time for movement; however far enough apart to avoid interruptions from other groups. For this lesson, four learning stations are required: one station for TPs 1 and 2 and one station each for TPs 3–5.

Based on the topographical map being used, create:

- a list of 10 conventional signs, to be used for TP 2;
- a list of 20 conventional signs for the cadets to determine four- and six-figure grid references (GRs), and a list of 20 four- and six-figure GRs for the cadets to determine the conventional signs, to be used for TP 3;
- two sets of GRs (one set for point-to-point and one set for along-a-route) for the cadets to measure distance on a map, to be used for TP 4;
- a set of GRs for the cadets to determine the bearing on a map, to be used for TP 4; and
- a 100-m straight flat course used to determine personal pace, to be used for TP 5.

A reconnaissance (recce) of the exercise area should be made to determine a site with several distinctive features to be used as prominent objects, to create a bearing course to be used for TP 5.

Create 4–6 three-leg map and compass courses to be used for TP 6. Each course will be listed as a set of four 6-figure GRs (the start point and the endpoint of each leg). Total length of each course should not exceed 2 km.

Determine a safety bearing in the event any groups become disoriented or lost.

PRE-LESSON ASSIGNMENT

Nil.

APPROACH

A practical activity was chosen for this lesson as it is an interactive way for the cadets to review the compass, topographical maps, GRs, distance on the map and on the ground, bearings on the map and on the ground, and to navigate a route using a map and compass in a safe and controlled environment. This activity contributes to the development of navigation skills and knowledge in a fun and challenging setting.

INTRODUCTION

REVIEW

Nil.

OBJECTIVES

By the end of this lesson the cadet shall navigate using a map and compass.

IMPORTANCE

It is important for cadets to navigate using a map and compass because it allows cadets another opportunity to practice skills learned in Proficiency Level Three.



Divide the cadets into four groups. Have the groups rotate between four learning stations: one station for TPs 1 and 2 and one station each for TPs 3–5. After the groups have been to all four stations, have them rendezvous at the designated location for TP 6.

Teaching Point 1

Review the compass.

Time: 10 min

Method: Practical Activity

BACKGROUND KNOWLEDGE

PRINCIPLES BEHIND THE WORKINGS OF A COMPASS

Regardless of intended purpose or complexity of construction, most compasses operate on the same basic principle. A small, elongated, permanently magnetized needle is placed on a pivot so that it may rotate freely on the horizontal plane. The earth's magnetic field, which is shaped approximately like the field around a simple bar magnet, exerts forces on the compass needle causing it to rotate until it comes to rest in the same horizontal direction as the magnetic field. Over much of the earth this direction is roughly running between north and south, which accounts for the compass's importance in navigation.

The earth has a north and south magnetic pole. These magnetic poles correspond roughly with the actual geographical poles. The north magnetic pole is located (2005 estimate) at approximately 82.7 degrees N latitude and 114.4 degrees W longitude, which lies over 800 km from the north geographic pole.

The horizontal force of the magnetic field, responsible for the direction in which a compass needle is oriented, decreases in strength as one approaches the north magnetic pole. This decrease is due to the lines of force changing direction towards the vertical as they bend back into the earth at the north magnetic pole towards the south magnetic pole. The compass starts to behave erratically, and eventually as the horizontal force decreases even more, the compass becomes unusable.

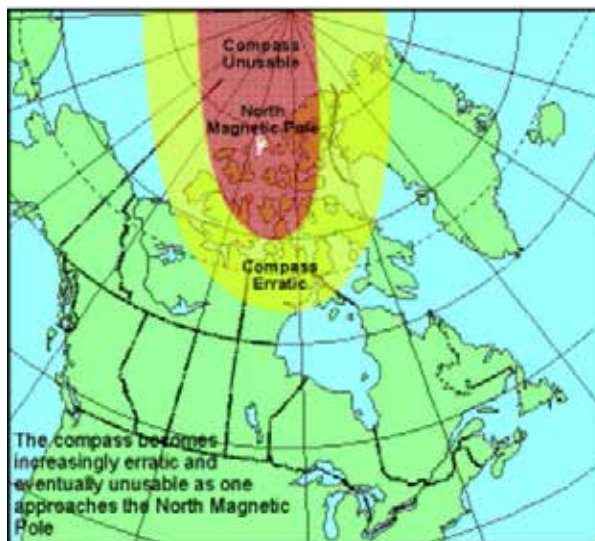

Figure 1 Earth's Magnetic Field

Note. From *Royal Canadian Army Cadet Reference Book* (p. 5-33), by Director Cadets 3, 2003, Ottawa, ON: Department of National Defence.

The nature of the earth's magnetic field is such that the magnetic north pole shifts geographic position about 5–10 km per year. Natural phenomena, like earthquakes, may also shift the magnetic field.

PARTS OF THE COMPASS

A - Sight. Located at the top of the compass cover. Used to align on an object when taking a bearing or to observe one along a given bearing.

B - Compass cover. Protects the compass dial and houses the sighting mirror.

C - Sighting mirror. Used to see the compass dial while taking a bearing.

D - Sighting line. Used when aligning an object or observing along a bearing.

E - Luminous index point. At the top of the compass dial and where a bearing is set or read from.

F - Compass dial. Houses the magnetic needle, the orienting arrow, the meridian lines, the declination scale (on the inside) and the dial graduations (on the outside).

G - Dial graduations. The compass dial is graduated in 2-degree divisions from 0 to 360 degrees. The dial is rotated by hand.

H - Orienting arrow. The black and red orienting arrow is located inside the compass dial and is used to line up with the magnetic needle when taking a bearing on the ground. The orienting arrow is what is adjusted when the magnetic declination is set.

I - Romer 1 : 25 000. Used to measure six-figure grid references (GRs) on maps with a 1 : 25 000 scale.

J - Compass base plate. A clear piece of flat plastic to which the cover, dial and lanyard are attached.

K - Declination scale. Used when adjusting the orienting arrow and while setting the magnetic declination for the map being used. It is graduated in 2-degree divisions.

L - Compass meridian lines. Black or red lines inside the compass dial. They are used to line up the compass dial with the grid lines (eastings) on a map.

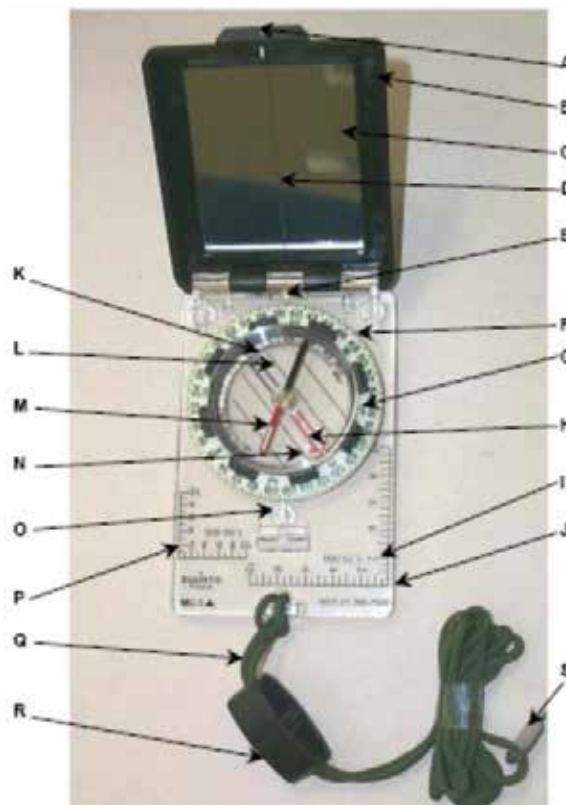

Figure 2 Compass

Note. From *Royal Canadian Army Cadet Reference Book* (p. 5-33), by Director Cadets 3, 2003, Ottawa, ON: Department of National Defence.

M - Magnetic needle. Spins freely and points towards magnetic north. The south end of the compass needle is black and the north end, with a luminous patch, is red.



When the magnetic needle is lined up in the red end of the orienting arrow, the mnemonic device "Red in the Bed" is used to remember that the red end of the needle belongs in the red end of the arrow.

N - Luminous orienting points. There are two luminous orienting points located on either side of the red end of the orienting arrow.

O - Luminous index point. At the bottom of the compass dial; where a back bearing is read from.

P - Romer 1 : 50 000. Used to measure six-figure GRs on maps with a 1 : 50 000 scale.

Q - Safety cord or lanyard. Used to fasten the compass to the wrist (never around the neck).

R - Adjustable wrist lock. Used to attach the compass to the wrist.

S - Screwdriver. Located at the end of the safety cord and is used to turn the screw to adjust the orienting arrow's position on the declination scale.

T - Declination adjusting screw. Located on the back side of the compass dial and is used to adjust the orienting arrow's position on the declination scale.

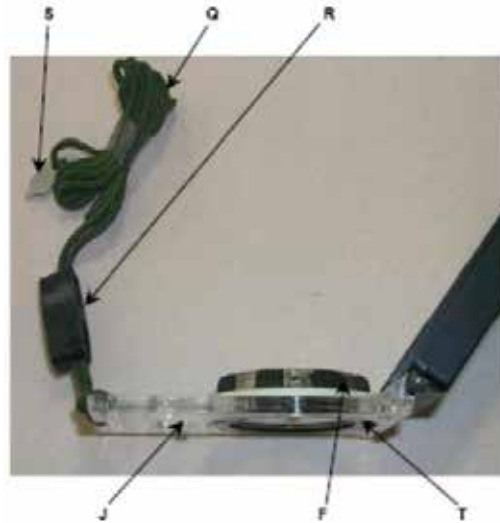

Figure 3 Compass

Note. From Royal Canadian Army Cadet Reference Book (p. 5-34), by Director Cadets 3, 2003, Ottawa, ON: Department of National Defence.



After being exposed to a strong light source, the luminous parts of the compass will glow in the dark making operating the compass at night possible.

HOW TO SET A PREDETERMINED DECLINATION

Declination

Magnetic declination is the difference in bearing either between grid north and magnetic north or between true north and magnetic north. Declination will change for each topographical map and it also changes annually due to the shifting north magnetic pole.



Cadets will almost always use the magnetic declination value between grid north and magnetic north (grid declination) when navigating using a map and compass. By setting the magnetic declination on the compass, magnetic bearings are converted to grid bearings which allow bearings taken from the map to be used on the ground and vice versa.

Declination is further described by stating whether the declination is east or west of magnetic north. The declination for the map being used is calculated using the information in the declination diagram (as illustrated in Figure 4) found in the marginal information of the map.



Declinations are stated in degrees and minutes. Each degree is subdivided into 60 minutes. This is important when setting the declination as the declination scale is graduated in 2-degree divisions.

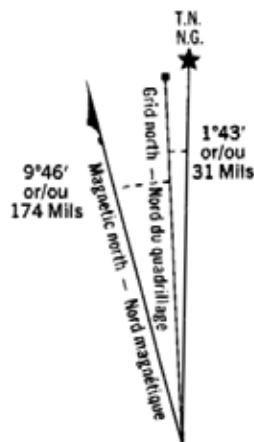

Use diagram only to obtain numerical values
 APPROXIMATE MEAN DECLINATION 1982
 FOR CENTRE OF MAP
 Annual change (increasing) 4.4'

N'utiliser le diagramme que pour obtenir les valeurs numériques.
 DÉCLINAISON MOYENNE APPROXIMATIVE
 AU CENTRE DE LA CARTE EN 1982
 Variation annuelle (croissante) 4.4'

Figure 4 Declination Diagram

Note. From *Royal Canadian Army Cadet Reference Book* (p. 5-39), by
 Director Cadets 3, 2003, Ottawa, ON: Department of National Defence.

Adjusting the Declination on a Compass

The compass's declination scale must be set to compensate for the difference between grid north and magnetic north. To do this, first have the amount of declination in degrees east or west. Then, turn the compass over and look at the back of the dial.

From the zero point, using the screwdriver, turn the declination adjusting screw to the right for west and to the left for east declination (as illustrated in Figure 5). Each small black line represents two degrees of declination.



When setting declination on a compass, it is easier to hold the screwdriver and turn the compass, especially in cold weather. The declination shall never be turned past the last number of the declination scale.



Figure 5 Declination Scale and Screw

Note. Created by Director Cadets 3, 2008, Ottawa, ON: Department of National Defence.



If a person were to follow a compass bearing for 1 km without first adjusting for declination, for every one degree of declination, that person would be over 17 m to the left or right of their plotted bearing. This is how important declination is.

ACTIVITY

Time: 5 min

OBJECTIVE

The objective of this activity is to have the cadets name a part of the compass and describe its purpose.

RESOURCES

Compasses.

ACTIVITY LAYOUT

Nil.

ACTIVITY INSTRUCTIONS

1. Hand out the compasses to the cadets.
2. Ask the cadets to describe how a compass works.
3. Point to a part of the compass and have a cadet name it and describe its purpose.
4. Rotate through all the cadets.

SAFETY

Nil.

ACTIVITY

Time: 5 min

OBJECTIVE

The objective of this activity is to have the cadets set four different magnetic declination values on a compass.

RESOURCES

- Compasses, and
- Predetermined declinations, to include:
 - 8 degrees W,
 - 15 degrees E,
 - 3 degrees 30 minutes E, and
 - 9 degrees 45 minutes W.



When verifying the declinations set by the cadets, the line at the end of the orienting arrow should be:

- 8 degrees W: directly over the fourth graduated line to the left of the zero mark.
- 15 degrees E: halfway between the seventh and eighth graduated line to the right of the zero mark.
- 3 degrees 30 minutes E: three quarters of the way from the first towards the second graduated line to the right of the zero mark.
- 9 degrees 45 minutes W: to the right of and beside the fifth graduated line to the left of the zero mark.

ACTIVITY LAYOUT

Nil.

ACTIVITY INSTRUCTIONS

1. Review magnetic declination.
2. Give the cadets a declination value.
3. Have the cadets turn the compass over (on its back with the declination adjusting screw facing up).
4. Have the cadets grasp the screwdriver attached to the safety cord / lanyard.
5. Using the screwdriver, have the cadets turn the declination adjusting screw to the right for west and to the left for east declination values and set the given declination.
6. Check the set declination.
7. Have the cadets repeat Steps 2–6 for each of the predetermined declinations.
8. Have the cadets set the declination to zero before returning the compasses.

SAFETY

Nil.

CONFIRMATION OF TEACHING POINT 1

The cadets' participation in the activities will serve as the confirmation of this TP.

Teaching Point 2

Review topographical maps.

Time: 10 min

Method: Practical Activity

BACKGROUND KNOWLEDGE

MARGINAL INFORMATION

The margins provide information important to the understanding and use of the map. Before using an unfamiliar map, it is important to have a good look at the information contained in its margins. The layout and contents of the marginal information is normally in the same place for all topographical maps, but will always be found within the margins. This information includes:

Name of map sheet. For ease of reference, the name of the map is usually a major community or district located on the map (found at the bottom centre of the margin, as well as in the top or bottom right corner).

Number of the map and index of adjoining maps. A diagram showing the position of the map sheet in relation to adjoining sheets is shown near the lower right-hand margin. The diagram shows the sheet numbers of the adjoining sheets and accentuates the sheet in hand.

Date of map data. Helps to indicate the amount of change that may have occurred since the map was printed (found in the bottom left corner).

Map scale. Indicates the scale of the map, most commonly 1 : 25 000 or 1 : 50 000. Scale is used to represent distances on the map in direct relation to the ground. On a 1 : 50 000 scale map 1 cm on the map represents 50 000 cm (500 m) on the ground.

Scale bars. Used as a measuring aid for determining distance on the map (found bottom centre below the map name). The left end of the scale bars is divided into tenths for measuring distances more accurately.

Contour interval. Indicates the vertical (height) interval between contour lines and is given in metres or feet. The contour interval is found in the bottom margin.

Legend of conventional signs. A table showing the conventional signs used on the sheet in their correct colours with their descriptions is shown in the bottom or side margin, plus in a more complete list on the back of the map.

Military index number. The index is found in the top right corner of the map sheet and used for ordering additional maps.

Declination diagram. Contains the information for the map on how true, grid, and magnetic north relate to each other. This information is given in the form of a diagram with explanatory notes. The diagram is in the right side margin.

Universal Transverse Mercator grid system (UTM). The UTM grid system divides the earth's surface into zones, each covering six degrees of longitude and eight degrees of latitude. The 60 longitude bands are

numbered and the 20 latitude bands are lettered. Each grid zone is one rectangle of the grid pattern, established by the bands and designated by the figures of the longitude band followed by the letter of latitude band.

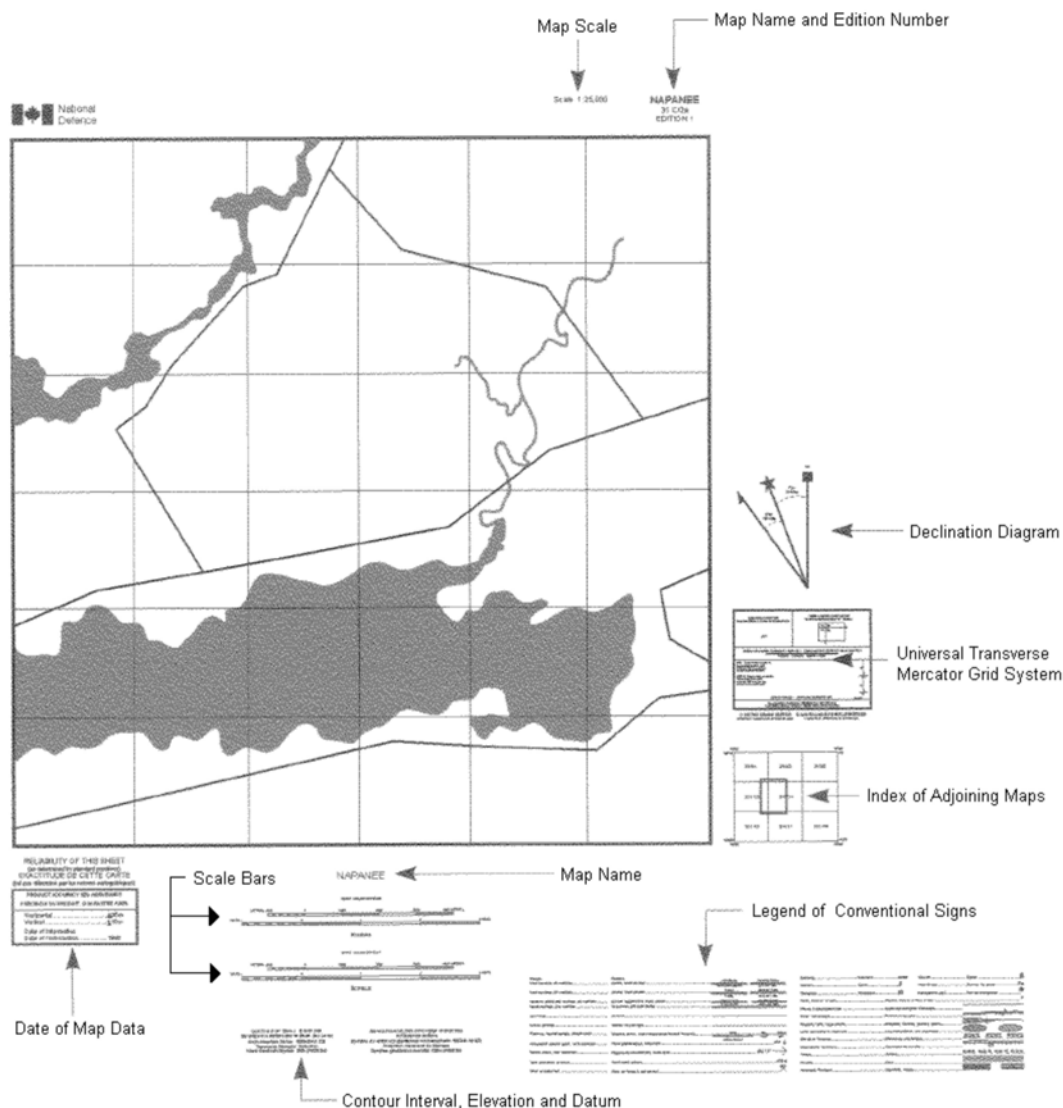

Figure 6 Marginal Information

Note. From *Maps, Field Sketching, Compasses and the Global Positioning System* (p. 11), by Directorate of Army Doctrine 8, 2006, Ottawa, ON: Copyright 2006 by Her Majesty the Queen in Right of Canada.

Military users, refer this map as:	SERIES A901 MCE 320 EDITION 1
------------------------------------	--------------------------------------

Figure 7 Military Index Number

Note. From *Maps, Field Sketching, Compasses and the Global Positioning System* (p. 12), by Directorate of Army Doctrine 8, 2006, Ottawa, ON: Copyright 2006 by Her Majesty the Queen in Right of Canada.

CONVENTIONAL SIGNS

A number of symbols are used to indicate an object or item of detail that cannot be shown either by outline or by a line symbol. Most have been established through long usage and standardization agreements. The meaning of most symbols is obvious. However, if there is doubt, consult the table of conventional symbols located on every map. Located on the back of most maps will be a chart listing many additional conventional signs.

Map-reading not only involves the ability to interpret the symbols shown on the map and to understand the information given in pictorial or written form, but it also involves a true understanding of the ground portrayed and an appreciation of the reliability and value of the particular map being used.

Where the symbol may have more than one meaning, the sign or symbol will be accompanied by a descriptive word (eg, tank or tower).

The use of colour aids in distinguishing details.

Red. Used to identify paved roads and highway numbers. Red is also used to shade in areas of urban development.

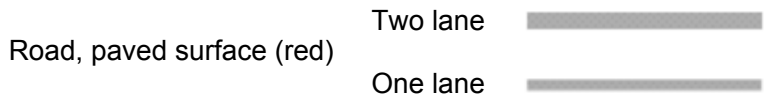

Figure 8 Red Conventional Signs

Note. Created by Director Cadets 3, 2008, Ottawa, ON: Department of National Defence.

Orange. Used to represent unpaved roads.

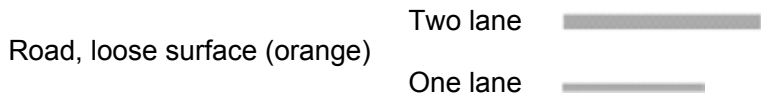
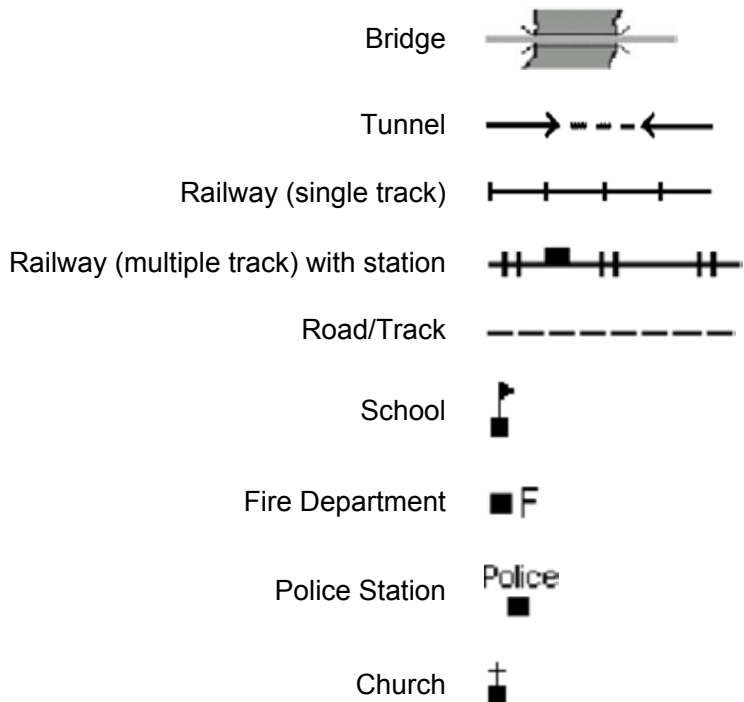

Figure 9 Orange Conventional Signs

Note. Created by Director Cadets 3, 2008, Ottawa, ON: Department of National Defence.

Black. Used for cultural features, toponyms (place names), some symbols and precise elevations.



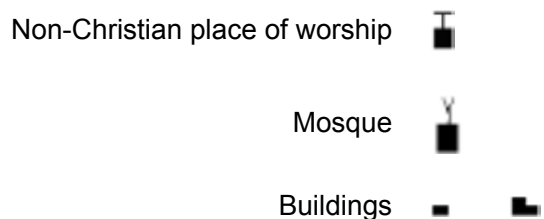

Figure 10 Black Conventional Signs

Note. Created by Director Cadets 3, 2008, Ottawa, ON: Department of National Defence.

Brown. Used for contour lines, contour elevations, spot elevations, sand, cliffs, and other geographical features.

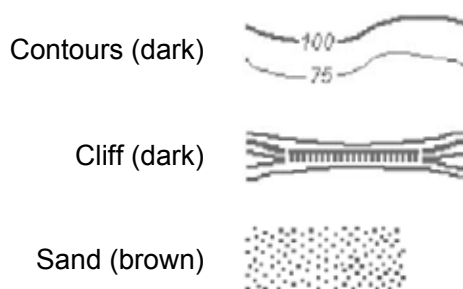

Figure 11 Brown Conventional Signs

Note. Created by Director Cadets 3, 2008, Ottawa, ON: Department of National Defence.

Blue. Used for water or permanent ice features (eg, rivers, lakes, swamps and ice fields), names of water features and the grid lines.

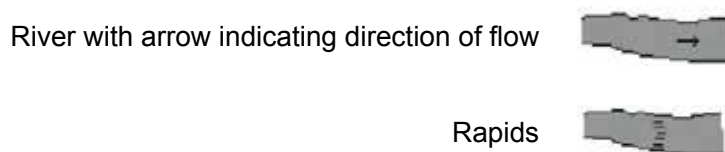

Figure 12 Blue Conventional Signs

Note. Created by Director Cadets 3, 2008, Ottawa, ON: Department of National Defence.

Green. Used for vegetation features such as woods, orchards and vineyards.

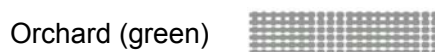

Figure 13 Green Conventional Signs

Note. Created by Director Cadets 3, 2008, Ottawa, ON: Department of National Defence.

White. Used to represent open fields.

Grey. Used for the legend of conventional signs on the back of the map.

Purple. Used for updates that are made over top of the original map information.

ACTIVITY

Time: 10 min

OBJECTIVE

The objective of this activity is to have the cadets locate marginal information and identify conventional signs on a topographical map.

RESOURCES

- Topographical maps, and
- List of conventional signs (as per pre-lesson instructions).

ACTIVITY LAYOUT

Large flat areas, preferably tables. If outside, use paperweights to hold down the maps.

ACTIVITY INSTRUCTIONS

1. Review the purpose of marginal information.
2. Review the purpose of conventional signs.
3. Have the cadets study the topographical maps.
4. Have the cadets locate the following marginal information:
 - a. declination diagram,
 - b. date of map data,
 - c. scale bars,
 - d. map name, and
 - e. contour interval.
5. Have the cadets locate conventional signs.

SAFETY

Nil.

CONFIRMATION OF TEACHING POINT 2

The cadets' participation in the activity will serve as the confirmation of this TP.



Send the group to their next learning station (only for the first three groups). If this is the last group, have them rendezvous at the designated location for TP 6.

Teaching Point 3**Conduct an activity to have the cadets review GRs.**

Time: 20 min

Method: Practical Activity

BACKGROUND KNOWLEDGE

FOUR-FIGURE GRs

Characteristics of a four-figure GR:

- Four-figure GRs will have four numerical digits derived from the numbers assigned to the eastings and northings on the map sheet.
- The numbers are listed by recording the two-digit easting followed by the two-digit northing.



The grid lines that intersect in the bottom left corner of the grid square are used to identify that grid square.

Steps to determine a four-figure GR:

1. Confirm the correct grid square.
2. Place a finger at the bottom left corner of the map.
3. Move that finger along the bottom of the map (left to right) up to the grid line (easting) before the grid square.
4. Record the two-digit easting.
5. Place a finger at the bottom left corner of the map.
6. Move that finger along the left side of the map (bottom to top) up to the grid line (northing) before the grid square.
7. Record the two-digit northing after the two-digit easting to create the four-figure GR.
8. Confirm the four-figure GR.

In Figure 14 Building A is located at GR 7433 and Building B at GR 7632.

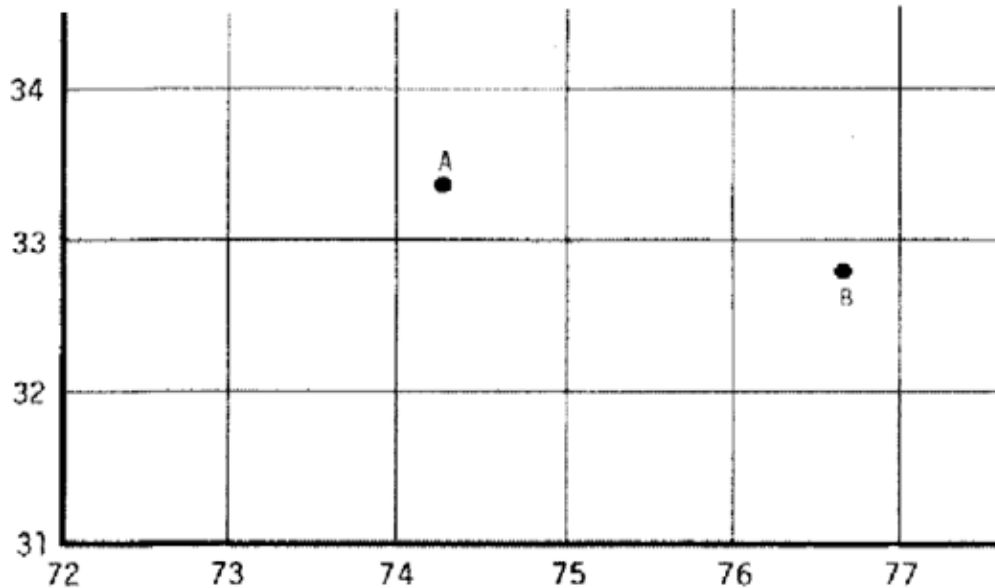

Figure 14 Four-Figure Grid References

Note. From *Maps, Field Sketching, Compasses and the Global Positioning System* (p. 37), Directorate of Army Doctrine 8, 2006, Ottawa, ON: Department of National Defence.

Steps to determine a grid square using a four-figure GR:

1. Confirm the four-figure GR.
2. Place a right-hand finger at the bottom left corner of the map.
3. Move that finger along the bottom of the map (left to right) up to the grid line (easting) numbered the same as the first two digits of the four-figure GR.
4. Place a left-hand finger at the bottom left corner of the map.
5. Move that finger along the left side of the map (bottom to top) up to the grid line (northing) numbered the same as the last two digits of the four-figure GR.
6. Move the right-hand finger up the grid line and the left-hand finger right along the grid line.
7. Where the two grid lines intersect is the bottom left corner of the grid square.
8. Confirm the correct grid square.

In Figure 14, GR 7532 represents the grid square southeast of Building A and west of Building B.

CONSTRUCTING A ROMER

Romer. A device used for measuring a point within a grid square to determine its six-figure GR.

Romers may be purchased or created. Purchased romers include compasses and protractors. Constructed romers use a small piece of paper and the scale bars of a topographical map.

Compass

Many compasses include romers already printed on the compass base plate. There are commonly two romers, for use with 1 : 25 000 and 1 : 50 000 scale topographical maps.

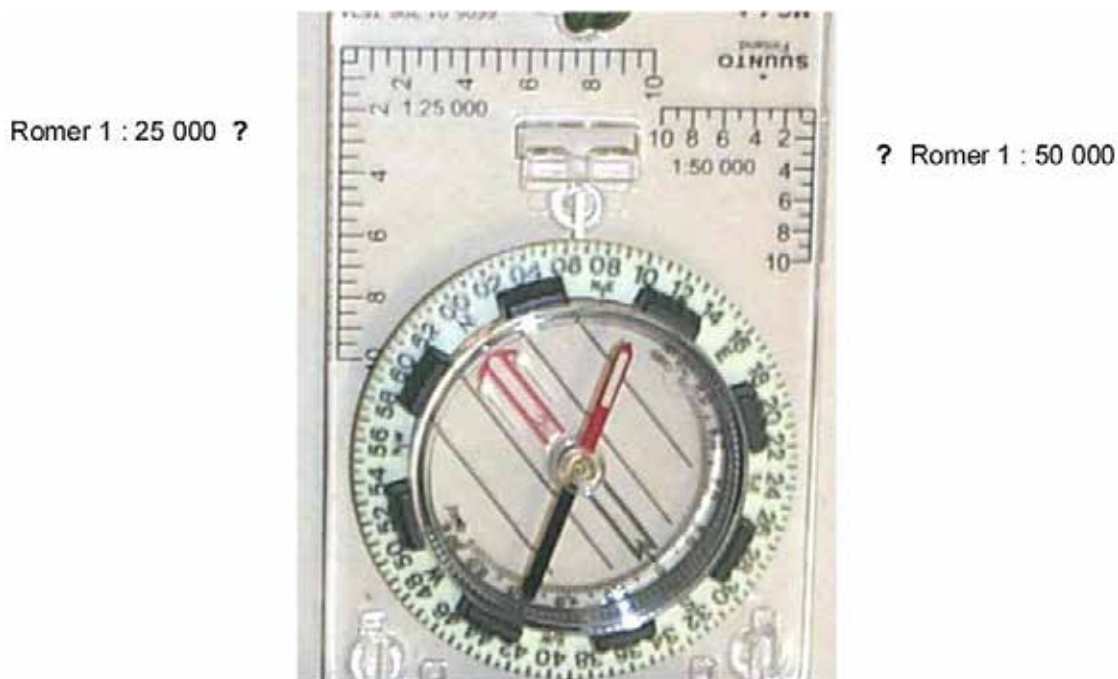

Figure 15 Compass

Note. Created by Director Cadets 3, 2008, Ottawa, ON: Department of National Defence.

Protractor

All protractors may be used to determine a bearing on a map, however, few have romers already printed on them. The Canadian Forces has created the C2 protractor (as illustrated in Figure 16) specifically designed for use on topographical maps.

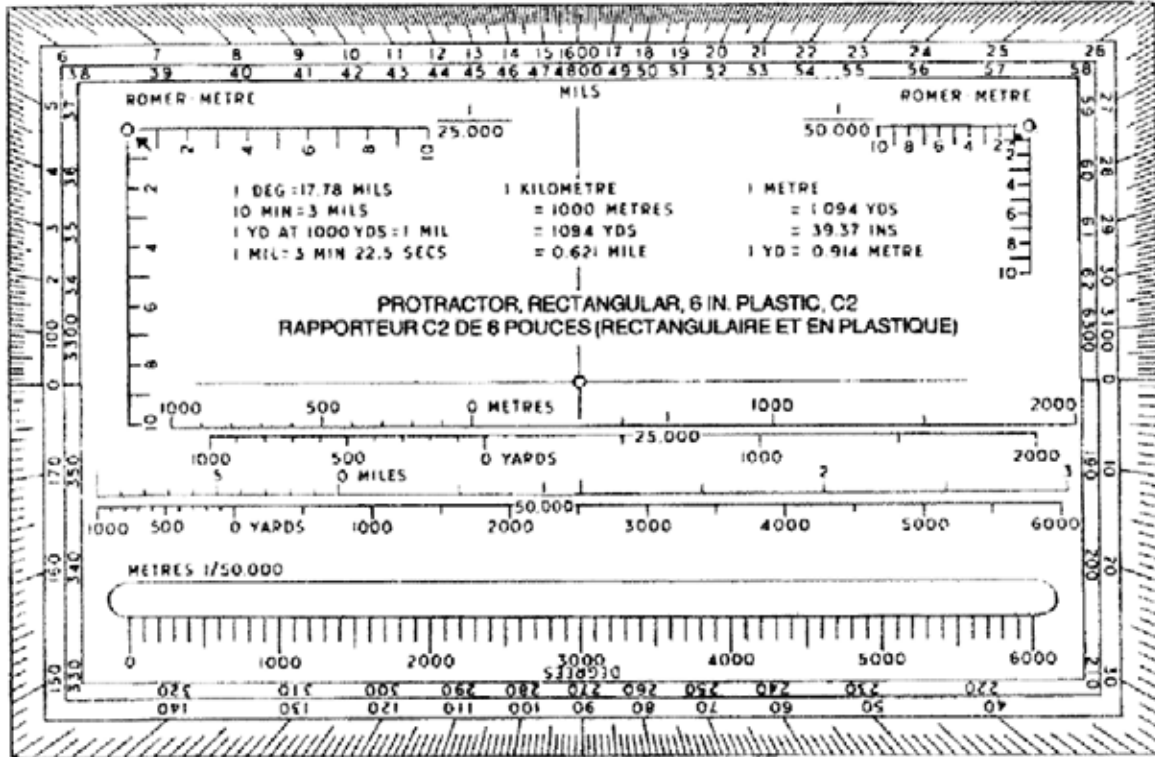

Figure 16 C2 Protractor

Note. From *Maps, Field Sketching, Compasses and the Global Positioning System* (p. 41), Directorate of Army Doctrine 8, 2006, Ottawa, ON: Department of National Defence.

Constructed

A constructed romer requires a piece of paper with at least one square corner and the scale bars of the topographical map. Using the scale bars of the topographical map, a romer can be constructed as illustrated in Figure 17.

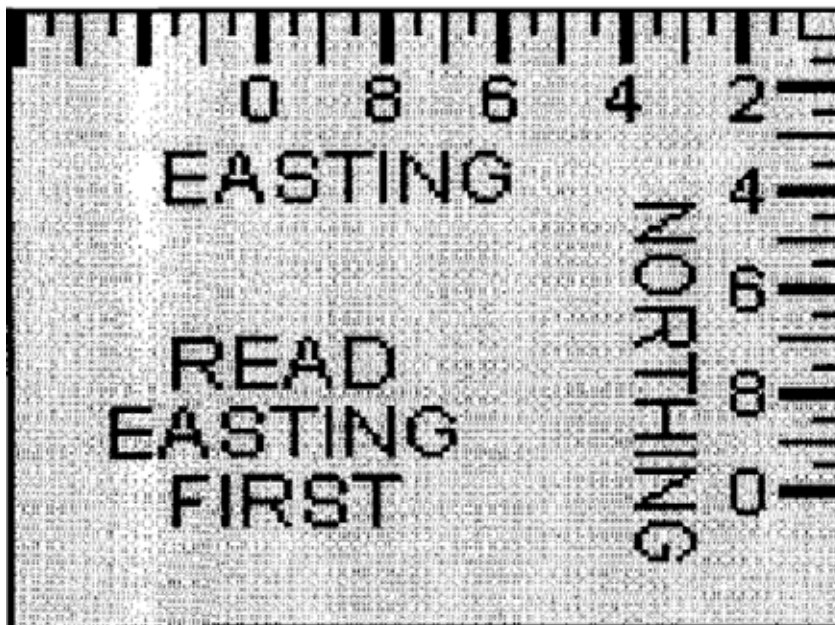

Figure 17 Constructed Romer

Note. From *Maps, Field Sketching, Compasses and the Global Positioning System* (p. 41), Directorate of Army Doctrine 8, 2006, Ottawa, ON: Department of National Defence.

Construct a romer for determining six-figure GRs by:

1. obtaining a blank piece of paper with a square edge;
2. placing one side of the square edge along the 100-m scale bars;
3. marking off 100-m segments beginning at the corner of the paper and working outward;
4. numbering these markings from zero (at the corner of the paper) to ten; and
5. repeating Steps 2–4 on the adjacent edge (eg, completed romer as illustrated in Figure 17).



It is important to use the correct scale bar. The constructed romer's markings should match the grid lines of the topographical map; the side of a grid square must be equal to ten 100-m marks on each of the romer's two edges.

SIX-FIGURE GRs

Determine a six-figure GR using a constructed romer by:

1. placing the corner of the constructed romer on the bottom left corner of the grid square, noting the four-figure GR;
2. moving the constructed romer to the right the number of tenths required to align the romer directly to or before (never past) the conventional sign or location for which the GR is being determined;

3. reading the value along the X-axis of the romer where it crosses the easting on the map sheet (the value at this intersection becomes the value for the third digit of the six-figure GR);
4. moving the constructed romer up the number of tenths required for the corner of the romer to be positioned on or before (never past) the conventional sign or location for which the GR is being determined;
5. reading the value along the Y-axis of the romer where it crosses the northing on the map sheet (the value at this intersection becomes the value for the sixth digit of the six-figure GR); and
6. combining the two sets of digits to create the six-figure GR.



Figure 18 Using a Constructed Romer

Note. From *Royal Canadian Army Cadet Reference Book* (p. 5-20), by Director Cadets 3, 2003, Ottawa, ON: Department of National Defence.

Determine what a six-figure GR represents using a constructed romer, by:

1. determining the four-figure GR, by removing the third and sixth digits from the six-figure GR, to identify and locate the correct grid square;
2. placing the corner of the constructed romer on the bottom left corner of the grid square;
3. moving the constructed romer to the right the number of tenths, as identified by the third digit;
4. moving the constructed romer up the number of tenths, as identified by the sixth digit; and
5. determining the object (that is up and to the right from the tip of the romer).

ACTIVITY

Time: 20 min

OBJECTIVE

The objective of this activity is to have the cadets determine four- and six-figure GRs and construct a romer.

RESOURCES

- Topographical maps,
- List of 20 conventional signs (as per pre-lesson instructions),
- Pens / pencils, and
- Paper.

ACTIVITY LAYOUT

Large flat areas, preferably tables. If outside, use paperweights to hold down the maps.

ACTIVITY INSTRUCTIONS

1. Have the cadets study the topographical maps.
2. Have the cadets determine the four-figure GR for each conventional sign.
3. Have the cadets determine the conventional sign of each four-figure GR.
4. Have the cadets construct a romer.
5. Have the cadets determine a six-figure GR for each grid square.
6. Have the cadets determine the conventional sign of each six-figure GR.

SAFETY

Nil.

CONFIRMATION OF TEACHING POINT 3

The cadets' participation in the activity will serve as the confirmation of this TP.



Send the group to their next learning station (only for the first three groups). If this is the last group, have them rendezvous at the designated location for TP 6.

Teaching Point 4

Conduct an activity to have the cadets review determining distance on a map and determining bearings on a map.

Time: 20 min

Method: Practical Activity

BACKGROUND KNOWLEDGE**DETERMINING DISTANCE ON A MAP**

Cadets can use a map to measure the distance between two points (eg, points A and B as illustrated at Figure 19) on the ground. All maps are drawn to scale; therefore, a specified distance on a map equals a specified distance on the ground. The scale of a map is printed at the top and bottom of each map (eg, scale 1 : 50 000). This means that 1 cm on the map equals 50 000 cm (500 m) on the ground.

There are two ways to determine distance on a topographical map—point-to-point and along-a-route.

Measuring Point-to-Point

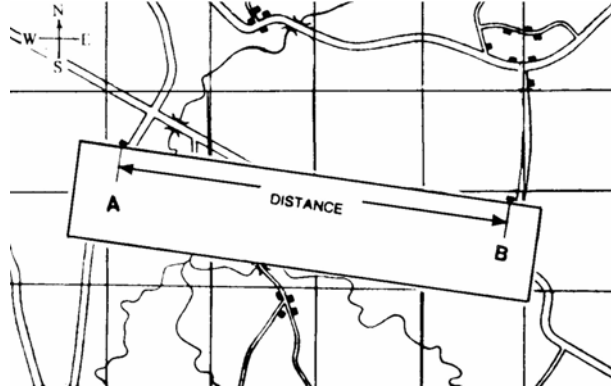

Figure 19 Measure Distance Point-to-Point

Note. From Royal Canadian Army Cadet Reference Book (p. 5-24), by Director Cadets 3, 2003, Ottawa, ON: Department of National Defence.

To measure a distance point-to-point:

1. Lay the straight edge of a piece of paper against the two points.
2. With a sharp pencil, mark the paper at the A (start) and B (end) points.
3. Lay the paper just under the metres scale bar with the B mark at the right end of the scale. Move the paper to the left, aligning the B mark with each thousand metre mark until the A mark falls within the subdivided thousands (hundreds) to the left of the zero.
4. To calculate the total distance, add the number of thousands where the B mark is, plus the number of subdivided thousands where the A mark is to the left of the zero.

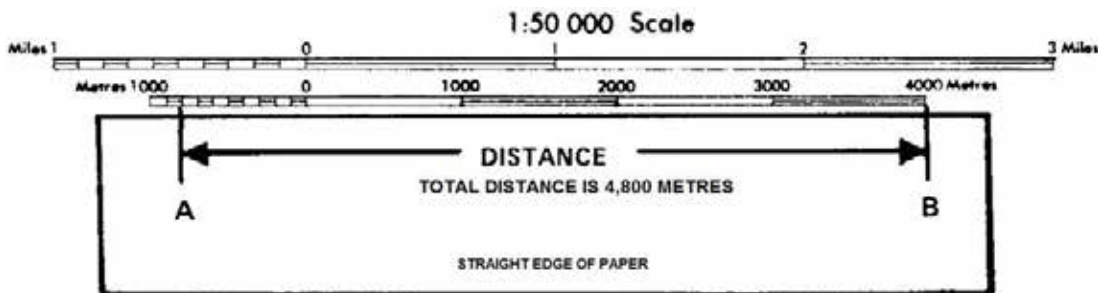

Figure 20 Calculate Distance

Note. From Royal Canadian Army Cadet Reference Book (p. 5-25), by Director Cadets 3, 2003, Ottawa, ON: Department of National Defence.



For a distance that is longer than 5 000 m, measure the first 5 000 m and mark the paper with a new line and label it '5 000 m'. Place the new mark at the zero or thousands mark until the A mark fits within the subdivided thousands (hundreds) bar. Add the total of that distance to the 5 000 m to create the total distance.

Measuring Along-a-Route Between Two Points

Sometimes cadets need to find the distance between A and B around the curves in a road along a planned route.

To measure a distance along a route between two points:

1. Lay the straight edge of a piece of paper against point A.
2. With a sharp pencil, mark point A on the paper and the map.
3. Line up the paper with the edge of the road until a curve is reached and make another mark on the paper and on the map.
4. Pivot the paper so that it continues to follow the road edge. Repeat until point B is reached.
5. Mark the paper and the map at point B.
6. Lay the paper just under the metres scale bar with the B mark at the right end of the scale. Move the paper to the left, aligning the B mark with each thousand metre mark until the A mark falls within the subdivided thousands (hundreds) to the left of the zero.
7. Add the number of thousands where the B mark is, plus the number of subdivided thousands (hundreds) where the A mark is to the left of the zero, to determine the total distance.

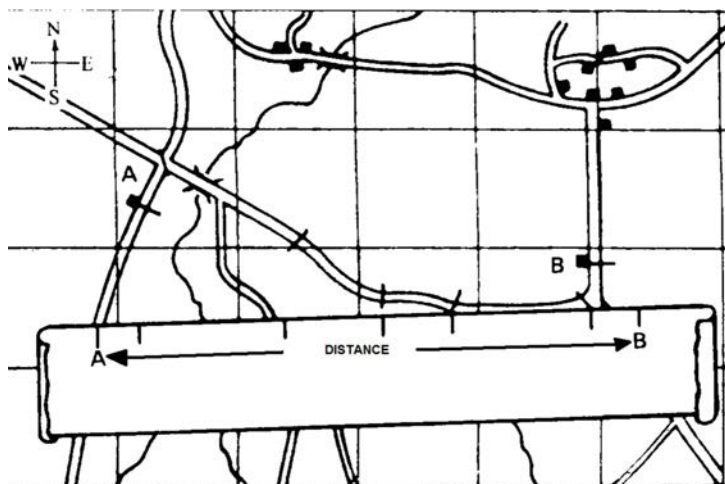

Figure 21 Measure Distance Along-a-Route

Note. From *Royal Canadian Army Cadet Reference Book* (p. 5-25), by Director Cadets 3, 2003, Ottawa, ON: Department of National Defence.

DETERMINING BEARINGS ON A MAP

In order to determine bearings on a map, the cadet needs to understand the points of a compass, the degree system, the three norths and types of bearings.

The 16 Points of a Compass



Figure 22 Compass Rose

Note. Created by Director Cadets 3, 2007, Ottawa, ON: Department of National Defence.

The four cardinal points of the compass, measured at right angles clockwise from north are:

- north (N) at 0 and 360 degrees,
- east (E) at 90 degrees,
- south (S) at 180 degrees, and
- west (W) at 270 degrees.

The four inter-cardinal points are located halfway between each of the cardinal points. Measured clockwise from north, they are:

- northeast (NE) at 45 degrees,
- southeast (SE) at 135 degrees,
- southwest (SW) at 225 degrees, and
- northwest (NW) at 315 degrees.

The eight intermediate points are located halfway between each cardinal point and inter-cardinal point. Measured clockwise from north, they are:

- north-northeast (NNE) at 22.5 degrees,
- east-northeast (ENE) at 67.5 degrees,
- east-southeast (ESE) at 112.5 degrees,
- south-southeast (SSE) at 157.5 degrees,

- south-southwest (SSW) at 202.5 degrees,
- west-southwest (WSW) at 247.5 degrees,
- west-northwest (WNW) at 292.5 degrees, and
- north-northwest (NNW) at 237.5 degrees.



As an aid to remember the different types of points:

- cardinal points are designated by one letter,
- inter-cardinal points are designated by two letters, and
- intermediate points are designated by three letters.

The Degree System

The cardinal, inter-cardinal, and intermediate points describe directions only to within one-sixteenth of a full circle. For a more precise indication of direction, it is necessary to use the sub-divisions of the circle called degrees. This measurement starts and ends at north (top) and is measured in a clockwise rotation.

Degrees. The most common method of dividing a circle is by degrees. These degrees represent 360 equal angles in a complete circle and they are represented by the symbol "°" (eg, 222°).



It is important to emphasize that degrees should always be measured clockwise and always using north as the start point.

The Three Norths

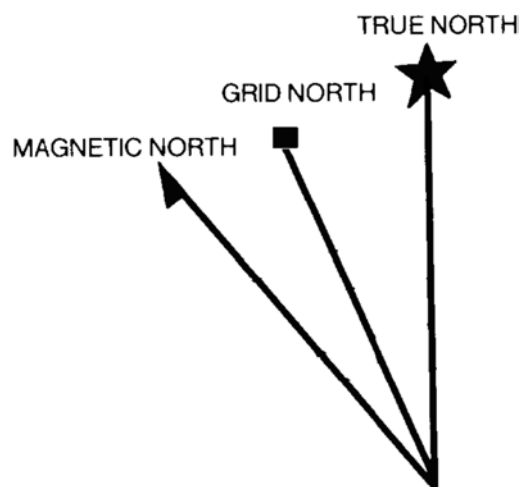

Figure 23 The Three Norths

Note. Created by Director Cadets 3, 2008, Ottawa, ON: Department of National Defence.

The relationship between the three norths, especially grid and magnetic, is key to using a compass on both a map and on the ground.

True north. True north is located at the top of the earth where the geographic North Pole is located, where all lines of longitude meet. In the declination diagram on the map, true north is represented by the symbol of a star, which represents the North Star, Polaris.

Grid north. Grid north is the north indicated by the grid lines (eastings) on a topographical map. The easting lines run parallel to each other and will never meet at the geographic North Pole; because of this, grid north points off slightly from true north. In the declination diagram on the map, grid north is represented by a square, which represents a map grid.

Magnetic north. Magnetic north is the location of the north magnetic pole, where the Earth's magnetic field bends back into the Earth toward the south magnetic pole. It is located in the Canadian arctic and is different from true north. It is the direction in which the compass needle points. In the declination diagram on the map, magnetic north is represented by a needle as on a compass.

The differences between the three norths affect navigation for the map and compass user, in the form of magnetic declination. Magnetic declination is the difference in bearing either between true north and magnetic north or between grid north and magnetic north.



Cadets will normally use the magnetic declination value between grid north and magnetic north when navigating using a map and compass. By setting the magnetic declination on the compass, magnetic bearings are converted to grid bearings which allow bearings taken from the map to be used on the ground and vice versa.

Types of Bearings

Bearing. A bearing is an angle that is measured clockwise, from north. It is measured in degrees and is relative to the observer.



In geometry, an angle is based on three points; a vertex, and two points, each of which designates a ray. For a bearing, the vertex is the point where the bearing is taken from, another point is north, and the last point is where the bearing is directed to. The north (either true, grid or magnetic) used identifies the type of bearing.

In ground navigation, one ray of the angle points north (usually grid north) and the other ray, known as a plotting ray, points to the object / direction.

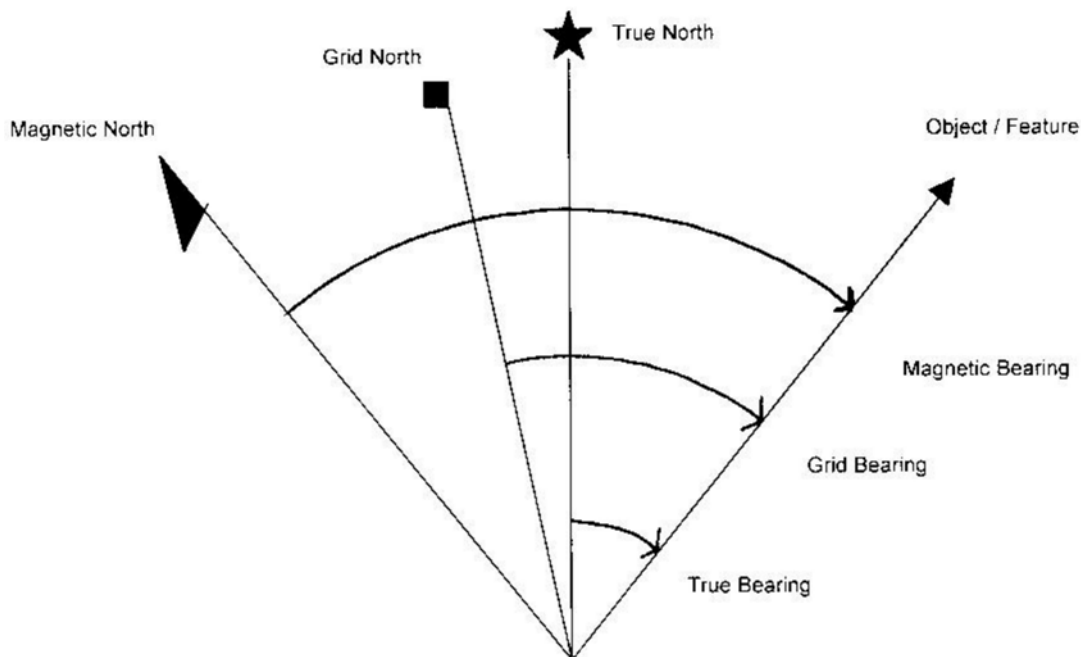

Figure 24 Types of Bearings

Note. Created by Director Cadets 3, 2008, Ottawa, ON: Department of National Defence.

True bearings. A true bearing is a bearing measured from true north. While map users rarely use them, directions determined using the sun, moon and stars are true bearings. Global Positioning System (GPS) receivers also use true bearings.

Grid bearings. A grid bearing is a bearing measured from grid north. The ability to determine a bearing from a map allows a map user to plan routes or activities before going into the field, and allows an easy method of communicating information about movement or location.

Magnetic bearings. A magnetic bearing is measured from magnetic north and is measured using a compass, which either has no option of setting magnetic declination or has the magnetic declination set to zero. A magnetic bearing is a quick and efficient method of describing a route when a map is not being used.



If a compass has its declination set to zero, bearings to objects on the ground determined by that compass are magnetic bearings. Setting the magnetic declination on a compass converts the magnetic bearings determined by that compass into grid bearings for the map being used.

Back bearing. A back bearing is a bearing that is in exactly the opposite direction of the bearing that has been measured. A back bearing can be useful for different reasons: to return to the start location after a hike, or to calculate the bearing from an object to one's current location. The steps to calculate a back bearing are:

- if the bearing is less than 180 degrees, add 180 degrees; and
- if the bearing is greater than 180 degrees, subtract 180 degrees.

ACTIVITY

Time: 20 min

OBJECTIVE

The objective of this activity is to have the cadets determine distances and bearings on a map.

RESOURCES

- Topographical maps,
- Sets of GRs for distances (as per pre-lesson instructions),
- Sets of GRs for bearings (as per pre-lesson instructions),
- Pens / pencils, and
- Paper.

ACTIVITY LAYOUT

Large flat areas, preferably tables. If outside, use paperweights to hold down the maps.

ACTIVITY INSTRUCTIONS

1. Have the cadets study the topographical maps.
2. Have the cadets determine the distance point-to-point on a map.
3. Have the cadets determine the distance along-a-route on a map.
4. Have the cadets identify the 16 points of a compass.
5. Have the cadets describe the degree system.
6. Have the cadets identify the three norths.
7. Have the cadets describe types of bearings.
8. Have the cadets determine a bearing on a map (as per created list).

SAFETY

Nil.

CONFIRMATION OF TEACHING POINT 4

The cadets' participation in the activity will serve as the confirmation of this TP.



Send the group to their next learning station (only for the first three groups). If this is the last group, have them rendezvous at the designated location for TP 6.

Teaching Point 5

Conduct an activity to have the cadets review determining distance on the ground and determining bearings on the ground.

Time: 20 min

Method: Practical Activity

BACKGROUND KNOWLEDGE

DETERMINING DISTANCE ON THE GROUND

Before distance can be determined on the ground, a method of measuring distance needs to be found. One such method is by determining one's own personal pace.

Determining a Personal Pace for 100 m

Being able to determine distance is a key skill for ground navigation. By learning how to determine distance using a personal pace, a cadet will have the skill to determine how far they have travelled, and how far they have to travel to reach their destination.

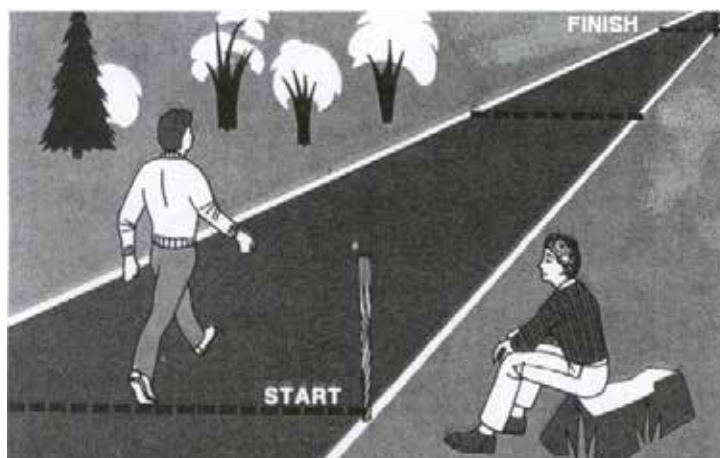

Figure 25 Determining Distance Using Pacing

Note. From *Be Expert With Map & Compass* (p. 53), by B. Kjellstrom, 1994, New York: Hungry Minds, Inc. Copyright 1994 by Bjorn Kjellstrom.

Personal pace. The number of paces a person walks over a distance of 100 m.

Counting Paces

There are two basic methods to count pace:

- count every pace (count every step); or
- count every other pace (count every left or every right step).

For example:

- count every pace: 140 paces = 100 m; or
- count every other pace: 70 paces = 100 m.

Calculating Distance

In order to determine distance travelled, the total number of paces travelled is divided by the personal pace and multiplied by 100 m to calculate the number of metres travelled.

Formula:

$$\frac{\text{total number of paces}}{\text{personal pace}} \times 100 \text{ m} = \text{total distance travelled (m)}$$

Example:

$$\frac{140 \text{ paces}}{70} \times 100 \text{ m} = 200 \text{ m}$$

Common methods of keeping track of the number of paces travelled include:

- transferring pebbles from one pocket to another: one pebble for each 100 paces;
- using a length of cord with knots—the knotted cord is held with the hand gripping a knot and the hand is advanced one knot down the cord for every 100 paces; and
- combining the knotted cord and pebbles (eg, cord with 10 knots, pebbles transferred for each completed cord [10 knots x 100 paces each = 1000 paces / pebble]).

Identifying Factors That Affect Pace

Factors that will affect personal pace include:

Terrain. The rougher the ground, the shorter the pace.

Slopes. Pace is shorter going uphill and longer going downhill.

Fatigue. Will shorten a person's pace.

Equipment. Footwear with poor traction will shorten a person's pace. Carrying a heavy load will also shorten a person's pace.

Weather. Snow and rain will shorten a person's pace. The wind will increase / decrease pace length if a person is travelling with / against the wind.

Obstacles. Going around small features (eg, trees, bushes) will affect pace count unless compensated for. Compensation methods include:

- **Sidestepping.** Stepping to the side (left / right) enough paces to bypass the obstacle, pacing forward past the obstacle and sidestepping back (right / left) to return to the original line of travel. This method maintains pace accuracy, but takes time.



The paces that the cadets sidestep are not added to their total pace count.

- **Alternating sides.** In this method, the cadet alternates which side (left / right) of the obstacle they pass (eg, last obstacle was passed on the left, next will be on the right). This method is less accurate, but faster.



If obstacles are always bypassed on the same side, the line of travel will veer off in that direction unless a distant steering point (eg, tall tree, hill top, building) is used as a guide.

DETERMINING BEARINGS ON THE GROUND

A compass can be used to determine the bearing for a direction of travel and from one's current location to a prominent object. The ability to take a bearing of a prominent object also allows the cadet to look for a prominent object as a steering point when they need to follow a given bearing. A bearing is a quick and accurate method for describing the direction of travel.



A prominent object is something that is usually tall and easily recognizable (eg, church steeple, tall tree or hilltop).



Figure 26 Determining a Bearing

Note. Created by Director Cadets 3, 2008, Ottawa, ON: Department of National Defence.



After the cadets have demonstrated the skill, have them practice determining the bearings of other prominent objects. This location should be predetermined by the recce IAW the pre-lesson instructions.

To determine the bearing of a prominent object:

1. Set the predetermined declination on the compass.
2. Hold the compass at eye level and at arm's length, and turn to face the prominent object (as illustrated in Figure 26).
3. Aim at the object using the compass sight, ensuring the sighting line is in line with the index pointer.
4. Adjust the compass cover so the compass dial is seen in the sighting mirror.

5. Look in the mirror and turn the compass dial until the magnetic needle is over the orienting arrow (put the red in the bed).
6. Read the number on the compass dial at the luminous index pointer.



Inform the cadets that when taking a bearing of a prominent object they will get different readings than other cadets unless they are all using the same line of sight to that prominent object (eg, standing in the same spot).

ACTIVITY

Time: 20 min

OBJECTIVE

The objective of this activity is to have the cadets determine distance on the ground and to determine bearings on the ground.

RESOURCES

- Compass, and
- Bearing course.

ACTIVITY LAYOUT

Pace course set up as per pre-lesson instructions. A bearing course with locations identified (spot to take bearing from and the prominent object / feature for which to take the bearing).

ACTIVITY INSTRUCTIONS

1. Have the cadets determine their personal pace using the pace course.
2. Have the cadets identify factors that affect pace.
3. Have the cadets determine bearings on the ground using the bearings course.

SAFETY

Nil.

CONFIRMATION OF TEACHING POINT 5

The cadets' participation in the activity will serve as the confirmation of this TP.



Send the group to their next learning station (only for the first three groups). If this is the last group, have them rendezvous at the designated location for TP 6.

Teaching Point 6**Have the cadets navigate a route using a map and compass.**

Time: 30 min

Method: Practical Activity

ACTIVITY**OBJECTIVE**

The objective of this activity is to have the cadets navigate a route using a map and compass.

RESOURCES

- Topographical map of the area,
- Predetermined magnetic declination,
- Set of four 6-figure GRs (the start point and the endpoint of each leg),
- Compass,
- Pencil, and
- Paper.

ACTIVITY LAYOUT

Four to six 3-leg map and compass courses, with the starting point for each course designated with a stake / marker.

ACTIVITY INSTRUCTIONS

1. Divide the cadets into groups of two.
2. Distribute a map, a compass, the predetermined magnetic declination, safety bearing, a set of four 6-figure GRs, a pencil and a sheet of paper to each group.
3. Brief the cadets on the activity, to include:
 - a. the purpose of the activity, and
 - b. safety.
4. Move the cadets to their start points.
5. Have the cadets complete their navigation exercise.
6. Have the cadets return their maps and compasses.

SAFETY

Nil.

CONFIRMATION OF TEACHING POINT 6

The cadets' participation in the activity will serve as the confirmation of this TP.

END OF LESSON CONFIRMATION

The cadets' navigating a route using a map and compass will serve as the confirmation of this lesson.

CONCLUSION

HOMEWORK / READING / PRACTICE

Nil.

METHOD OF EVALUATION

Nil.

CLOSING STATEMENT

Map and compass skills are important when training in a field setting. It allows groups to navigate within the training area in a safe manner. Survival training usually requires working within the bush away from the main exercise site. Understanding and practicing these skills allows the cadets to help plan survival training and organize routes between the main exercise site and the aircrew survival training areas.

INSTRUCTOR NOTES / REMARKS

TPs 1–5 are taught by learning stations. Divide the cadets into four groups and have the groups rotate between four learning stations: one station for TPs 1 and 2 and one station each for TPs 3–5.

To preserve and reuse the maps, they should be covered or coated with mac tac to allow the use of dry-erase markers instead of pencils or pens.

Assistant instructors and cadets who are qualified Survival Instructor may assist with this instruction.

REFERENCES

A2-036 A-CR-CCP-121/PT-001 Director Cadets 3. (2003). *Royal Canadian Army Cadet reference book*. Ottawa, ON: Department of National Defence.

A2-041 B-GL-382-005/PT-001 Directorate of Army Doctrine 8. (2006). *Maps, field sketching, compasses and the global positioning system*. Ottawa, ON: Department of National Defence.

C0-111 ISBN 978-0-9740820-2-8 Tawrell, P. (2006). *Camping and wilderness survival: The ultimate outdoors book* (2nd ed.). Lebanon, NH: Author.

C2-041 ISBN 978-0-07-1361101-3 Seidman, D., & Cleveland, P. (1995). *The essential wilderness navigator*. Camden, ME: Ragged Mountain Press.



**ROYAL CANADIAN AIR CADETS
PROFICIENCY LEVEL FOUR
INSTRUCTIONAL GUIDE**



SECTION 11

EO C490.06 – ERECT, TEAR DOWN AND PACK TENTS

Total Time:	120 min
-------------	---------

PREPARATION

PRE-LESSON INSTRUCTIONS

Resources needed for the delivery of this lesson are listed in the lesson specification located in A-CR-CCP-804/PG-001, *Proficiency Level Four Qualification Standard and Plan*, Chapter 4. Specific uses for said resources are identified throughout the instructional guide within the TP for which they are required.

Review the lesson content and become familiar with the material prior to delivering the lesson.

Additional instructors are required for this lesson to ensure TP 1 is covered in the time allotted.

PRE-LESSON ASSIGNMENT

Nil.

APPROACH

An interactive lecture was chosen for TP 1 to give direction on factors to consider when selecting a site.

A demonstration and performance was chosen for TPs 2 and 3 as it allows the instructor to explain and demonstrate erecting, tearing down and packing tents while providing an opportunity for the cadets to practice the skills under supervision.

INTRODUCTION

REVIEW

Nil.

OBJECTIVES

By the end of this lesson the cadet shall have the opportunity to erect, tear down and pack a two-section modular tent with walls and either an arctic tent or a civilian-pattern tent.

IMPORTANCE

It is important for the cadets to be able to use a modular tent because they are often used during aircrew survival exercises. A cadet's understanding of this lesson will allow them to better assist in the set-up of an aircrew survival exercise.

Teaching Point 1

Discuss site selection.

Time: 10 min

Method: Interactive Lecture

SITE SELECTION

When selecting a tent site on snow-covered ground, choose an area free from crevices. Prod the surface to ensure that a flat base is selected. The snow shall be removed until a firm base is exposed. The tent shall, if possible, be positioned so that its side is located downwind to avoid drifting snow blocking the entranceway.

When setting up an exercise site, it is important to know where to locate your sites for tents. There are factors to consider when doing this and they should be followed correctly as it is beneficial to everyone. The factors to consider are:

- Vehicle access for set-up and equipment transport.
- Inspecting the area for proximity to a water source that provides potable water and food from fishing.
- Inspecting for proximity to a fuel source for fire during cold weather.
- Inspecting for proximity to building materials.
- Inspecting proximity to animal trails and holes.
- Inspecting an entrance that is sheltered from the wind and preferably in the direction of the sun.
- Placing the tents away from the cooking area.

ACTIVITY

Time: 5 min

OBJECTIVE

The objective of this activity is to have the cadets find a site that is suitable for setting up tents.

RESOURCES

Nil.

ACTIVITY LAYOUT

Nil.

ACTIVITY INSTRUCTIONS

Have cadets, in pairs, find suitable sites for setting up tents.

CONFIRMATION OF TEACHING POINT 1

The cadets' participation in the activity will serve as the confirmation of this TP.

Teaching Point 2

Explain, demonstrate and have the cadets, as a member of a group, erect, tear down and pack a two-section modular tent with walls.

Time: 70 min

Method: Demonstration and Performance



For this skill, it is recommended that the instruction take the following format:

1. Explain and demonstrate each step in erecting, tearing down and packing a modular tent.
2. After demonstrating each step have the cadets perform the skill while monitoring their performance.

Note: Assistant instructors may be employed to monitor the cadets' performance.



If the modular tent is going to remain erected for the duration of the exercise, instruct tearing down and packing at the end of the exercise.

COMPONENTS OF A MODULAR TENT

A module of tent is comprised of a canvas section supported by tubular aluminum framework. It measures 2.5 m long by 5.5 m wide. The frame of a modular tent consists of two arch frames and three purlins (the horizontal beams along the length of the roof that support the canvas). The arch frame is hinged at the peak and the eaves. When folded the arch measures 2.75 m long. The purlins are 2.5 m long and connect two arches; one purlin at the peak and two more at each eave. They are locked into place without the use of tools. The framework is anchored with steel pegs which are inserted at the base of each arch and can be diagonally cross braced with cables or straps, between the eaves and base of the arches, to give an unobstructed inside space and an outside perimeter clear of guy wires. Guy wires are only used when the tent requires further reinforcement.

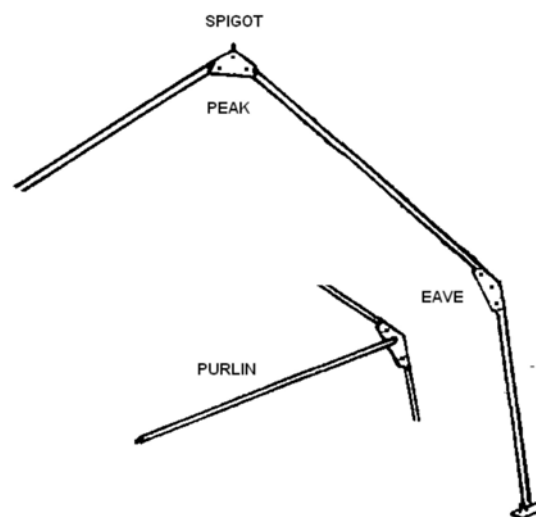

Figure 1 Frame

Note. Created by Director Cadets 3, 2007, Ottawa, ON: Department of National Defence.

TENT SECTIONS

The three tent sections are centre sections, front walls and rear walls. The tent sections attach to one another by means of a series of cord loops and grommets known as "Dutch lacing". The cord loops are on the opposite side of the grommets requiring all sections to be placed in the same direction. For example, all the cord loops on the right. Tent sections are made of olive green, core-spun, polyester-cotton, rip-stop woven material treated to be water-, rot- and flame-resistant. The sod cloth which extends 40 cm from the foot of each tent section is made from plastic-coated, waterproof material. The windows are screened and have blackout flaps and transparent vinyl panels which are attached with fastener tape (Velcro).

Centre section. This is the canvas roof and side wall covering of a module. It has a window in each side and a chimney opening in the roof.

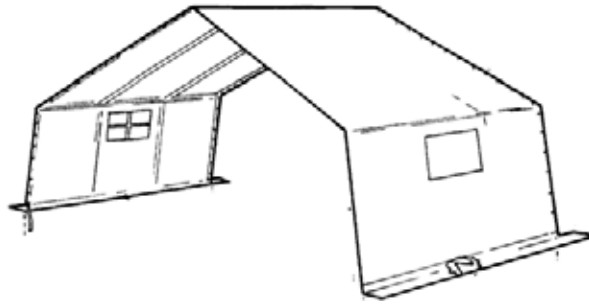

Figure 2 Centre Section

Note. From C-87-110-000/MS-000 *Operational Support and Maintenance Manual for Tent, Main*(p. 1-5), by DND Canada, 1983, Ottawa ON: Department of National Defence. Copyright 1983 by DND Canada.

Front wall. Attaches with grommets and opens with two zippered personnel doors. The front wall includes one window and a closable air vent.

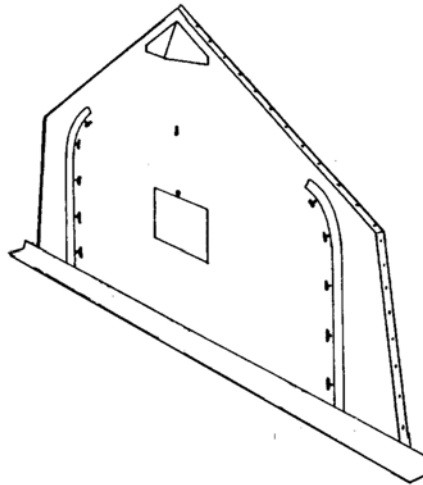

Figure 3 Front Wall

Note. From C-87-110-000/MS-000 *Operational Support and Maintenance Manual for Tent, Main*(p. 1-5), by DND Canada, 1983, Ottawa ON: Department of National Defence. Copyright 1983 by DND Canada.

Rear wall. Attaches with cord loops and opens in the centre. The opening reaches the peak of the module and is fastened with toggles, allowing access for large equipment. The rear wall includes two windows.

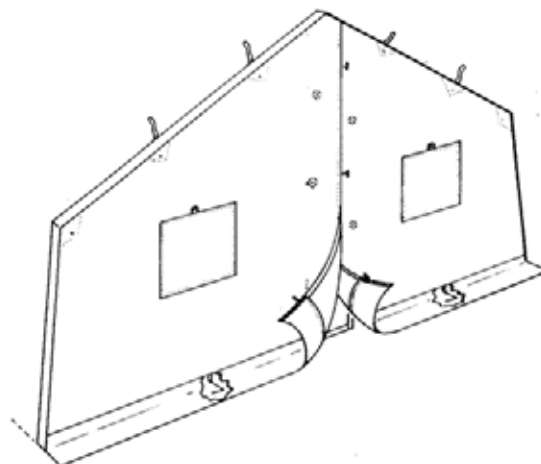

Figure 4 Rear Wall

Note. From C-87-110-000/MS-000 *Operational Support and Maintenance Manual for Tent, Main*(p. 1-5), by DND Canada, 1983, Ottawa ON: Department of National Defence. Copyright 1983 by DND Canada.

ACCESSORIES

Liners. The three common tent sections—centre section, front wall and rear wall—each have corresponding white fabric liners. These provide insulation as well as a light reflective surface, and are made from flame resistant material. The liners are suspended from inside the frame and are laced together similar to the tent sections.

Blackout hallway. Black fabric enclosure, 2.5 m long, attached inside the tent and laced to a grommet by the doorway, to prevent the entranceway from emitting light.

Lacing band. Provides the cord loops, to tie the two tent sections together when the module lacing sequence is disrupted because two grommet ends meet. It is 8.5 m long and 15 cm wide. A strap and a hooked shock cord are at each end to secure it to the frame and keep the band taut against the canvas.

Guy wires. Lines of cord that assist in securing the tent to the ground. Available for situations where the footings cannot be anchored in the ground or where the tent is subject to extreme windy conditions.

Bag tent. This is a flat canvas wrap specifically designed for containing tent sections. It includes a pocket to hold pertinent hardware.

Tools. A mallet, shovel and occasionally a stepladder. Tools are not included.



Explain tent maintenance to the cadets, but do not demonstrate or have the cadets perform.

TENT MAINTENANCE

The following precautionary measures, when followed, will protect the tent components from corrosion, mildew, rot and unnecessary damage and will work to prolong the life and usefulness of the tentage:

- Avoid folding or packing tent or liner sections when wet. Wet or damp tentage shall be unfolded and air dried within 48 hours.
- Protect tent and liner sections from petroleum and chemical stains. If soiling occurs, clean immediately with warm soapy water.
- Do not allow oil, mud or other foreign matter to gather or harden on frame components. Warm soapy water or cleaning solvents are recommended for cleaning. The components should not be lubricated.
- Do not leave collapsed tent sections and components in contact with the ground or exposed to the elements for more than 48 hours.
- All detected damage should be identified, reported and repaired at the earliest convenience.
- Dragging tentage on the ground, walking on tentage and general rough handling is prohibited.
- Effort shall be made to keep tentage equipment serviceable at all times and preventative maintenance practices must be employed during use.
- Erect and tear down tentage in accordance with the detailed procedures.



Explain, demonstrate and have the cadets perform each step in erecting, tearing down and packing.

ERECTING

Lay Out and Connect the Frame

Expand all arch frames leaving the legs in a folded position and space them in module increments using a purlin as a measure. Connect the purlins to each arch at the peak and eaves.

Lock the Frame

To operate the connecting, locking device on the peak bracket, first ensure the lock is released by:

1. placing the button head pin of the purlin into the bracket keyhole and push it upward in the keyhole slot;
2. moving the sliding bar up to allow the pivot lock to be swung over to hold the purlin in place;
3. moving the sliding bar down to lock the pivot;
4. operating the save bracket lock by lifting the sliding bar; and
5. releasing the arch frame leg from its erected state and moving down the lever lock, located inside the eave bracket.

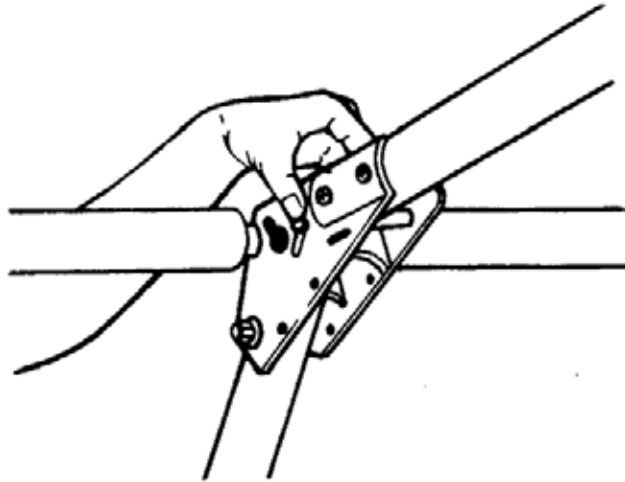

Figure 5 Frame Lock

Note. From C-87-110-000/MS-000 *Operational Support and Maintenance Manual for Tent, Main*(p. 2-5), by DND Canada, 1983, Ottawa ON: Department of National Defence. Copyright 1983 by DND Canada.

Connect Tent Sections

Identify the tent sections and position them so the front-rear sequence of lacing corresponds to the front and rear wall location. Lace the centre sections together using the dutch lace as follows:

1. Sandwich the grommet side between the flaps on the lacing side.

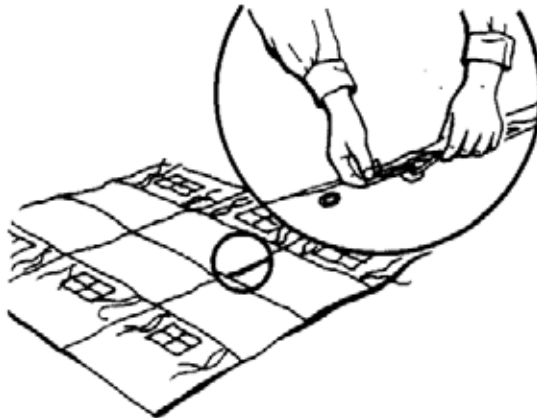

Figure 6 Canvas Lacing

Note. From C-87-110-000/MS-000 *Operational Support and Maintenance Manual for Tent, Main*(p. 2-8), by DND Canada, 1983, Ottawa ON: Department of National Defence. Copyright 1983 by DND Canada.

2. Pass the cord loops through the corresponding grommet holes and then through the next loop working from the centre outwards.

3. Tie off the last loop.

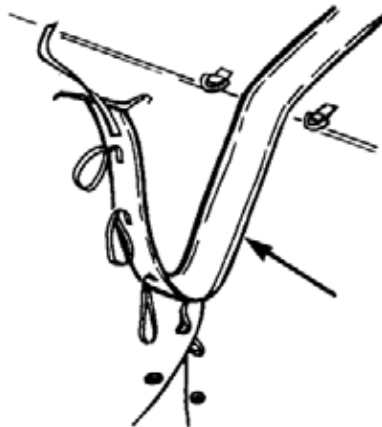

Figure 7 Canvas Lacing

Note. From C-87-110-000/MS-000 *Operational Support and Maintenance Manual for Tent, Main*(p. 1-8), by DND Canada, 1983, Ottawa ON: Department of National Defence. Copyright 1983 by DND Canada.

Raise the Side and Place Canvas

The following steps outline the procedure for raising the modular tent structure and placing the canvas:

1. Ensure the doors on the front and rear walls are closed. If the doors are left open they will be difficult to close after the modular tent is erected.
2. Raise one side of the frame with one person assigned to each arch frame. In windy conditions, temporarily secure the upright section to the ground with the tent pegs.



Figure 8 Erect One Side

Note. From C-87-110-000/MS-000 *Operational Support and Maintenance Manual for Tent, Main*(p. 2-8), by DND Canada, 1983, Ottawa ON: Department of National Defence. Copyright 1983 by DND Canada.

3. Place the previously folded canvas on the sloped side of the frame, positioning the master grommets (large holes at the peak of the canvas) over the frame spigots (large point at the peak of the frame), and then unfold the canvas onto the raised side.



Figure 9 Place Canvas

Note. From C-87-110-000/MS-000 *Operational Support and Maintenance Manual for Tent, Main*(p. 2-8), by DND Canada, 1983, Ottawa ON: Department of National Defence. Copyright 1983 by DND Canada.

4. Secure eave and foot straps on the raised side.
5. Attach the front and rear walls to the centre sections along the roof line only.
6. Raise the other side of the tent and align legs.
7. Attach save straps (straps on the underside of the canvas that attach to the purlins as illustrated in Figure 10) and bracing cables (support cables as illustrated in Figure 11) but do not tighten.

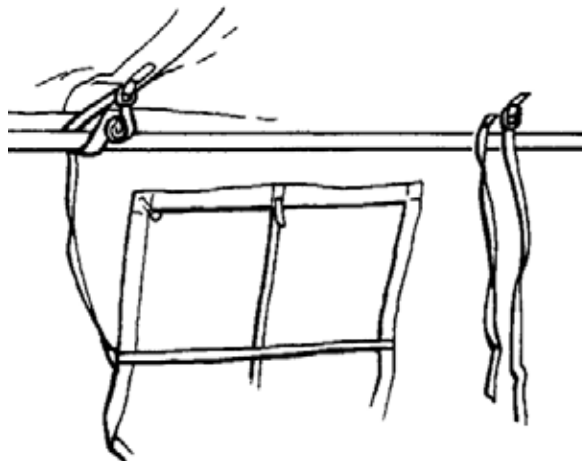

Figure 10 Save Straps

Note. From C-87-110-000/MS-000 *Operational Support and Maintenance Manual for Tent, Main*(p. 2-8), by DND Canada, 1983, Ottawa ON: Department of National Defence. Copyright 1983 by DND Canada.

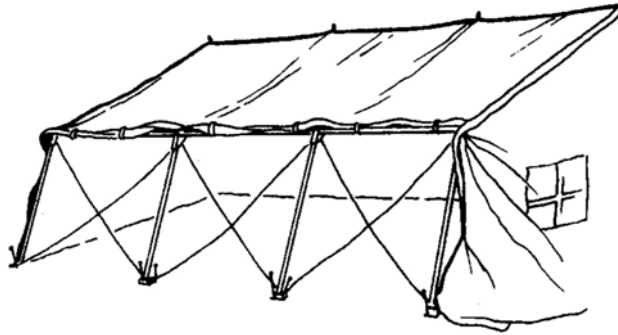

Figure 11 Bracing Cables

Note. From C-87-110-000/MS-000 *Operational Support and Maintenance Manual for Tent, Main*(p. 2-8), by DND Canada, 1983, Ottawa ON: Department of National Defence. Copyright 1983 by DND Canada.

8. Complete lacing the end walls to the centre sections.
9. Raise the other side and adjust the positioning and alignment of the arch legs to achieve a smooth canvas fit.

Anchor

The following steps outline the procedure for anchoring the modular tent to the ground:

1. Secure the frame to the ground. Hammer in the steel pegs (two per foot), working from the outside of the tent, so that the pegs are angled inwards (to prevent frame lifting as illustrated in Figure 12).

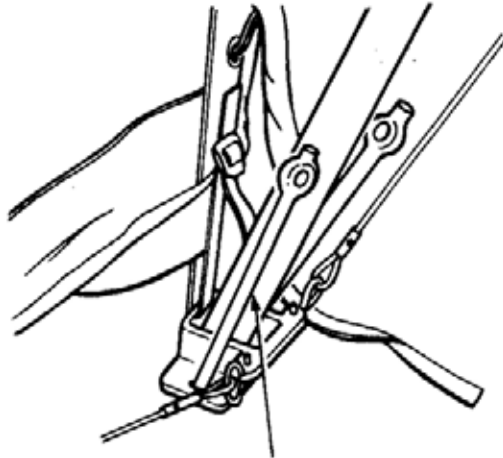

Figure 12 Drive in Pegs

Note. From C-87-110-000/MS-000 *Operational Support and Maintenance Manual for Tent, Main*(p. 2-8), by DND Canada, 1983, Ottawa ON: Department of National Defence. Copyright 1983 by DND Canada.

2. Tighten bracing cables or bracing straps to maximum tension.
3. Attach the foot strap, cinching to the maximum.
4. When using bracing cables, connect the vertical hold anchors with the corresponding D rings at the anchor points along the ground line of the canvas.

5. Drive the pegs into the ground under the sod cloth so that the side wall canvas is taut.
6. Connect the sod cloth flaps with the toggles and loops at the corners and along the sides. Place sod, snow or other suitable material on the sod cloths to prevent the wind from getting underneath them.



A trench is sometimes required when the tent is pitched on poor draining ground such as a flat, clay or heavy soil surfaces or shallow soil over bed rock. Sandy soils or areas which slope off normally do not require drainage trenches. The trench should be 20 cm wide by 15 cm deep. Slope the trench so that it drains away from the tent. Dig outlet drains at the lowest points of the trench, ensuring that they do not interfere with pedestrian or vehicular movement.



Only dig a trench if the situation requires.

TEARING DOWN

The reverse order for erecting is used to tear down a modular tent. The steps are:

1. Loosen the cables and ground anchors and remove (if wind is not too strong), otherwise leave until the tent is lowered.
2. Remove material from the sod cloth.
3. Release all straps and lacing up to the eave purlins.
4. Lower the tent one side at a time.
5. Unlace tent walls and sections and remove from frame.
6. Dismantle frame (reverse procedure).

Ensure that arrangements are made to clean and dry the equipment, if required, at the earliest opportunity.

PACKING



A diagram of the packing procedures is located at Attachment A.

To pack a modular tent, use the following steps:

1. Lay out the canvas with the outer surface facing the ground, for ease of cleaning.
2. Fold the front and rear walls by:
 - a. bringing the peak and sides of the wall toward the centre to square off the wall;
 - b. bringing the ends of the walls to the centre of the wall;

- c. folding the wall in half; and
 - d. folding the opposite way to complete the process; and
3. Fold the centre section by:
- a. taking the ends of the section and placing them in the centre of the section;
 - b. taking one end and folding it across to the other end;
 - c. taking the section and folding it into thirds;
 - d. folding the section in half; and
 - e. folding the section in half in the opposite direction.

CONFIRMATION OF TEACHING POINT 2

The cadets' participation in erecting, tearing down, and packing a modular tent will serve as the confirmation of this TP.

Teaching Point 3

Explain, demonstrate and have the cadets, as a member of a group, erect, tear down and pack an arctic tent or civilian-pattern tent.

Time: 30 min

Method: Demonstration and Performance



These descriptions and instructions will be given as the tent is being erected, torn down and packed.

If the tent is going to remain erected for the duration of the exercise, instruct tearing down and packing at the end of the exercise.

COMPONENTS OF A 5- OR 10-PERSON ARCTIC TENT

The 5- and 10-person arctic tents are bell-shaped with a pentagonal base. Each wall section of the pentagon has a snow flap attached to the bottom portion of its panel. The tent consists of an inner and an outer portion. The inner portion is most commonly used for cadet training and consists of a zipper door, base tie-down points, air vents, stove pipe openings and a reinforced apex for pole insertion. The tent is supported by a single telescopic centre pole and 16 (10-person) or 10 (5-person) guy wires. The guy wires are pegged down with lightweight alloy or plastic pegs.

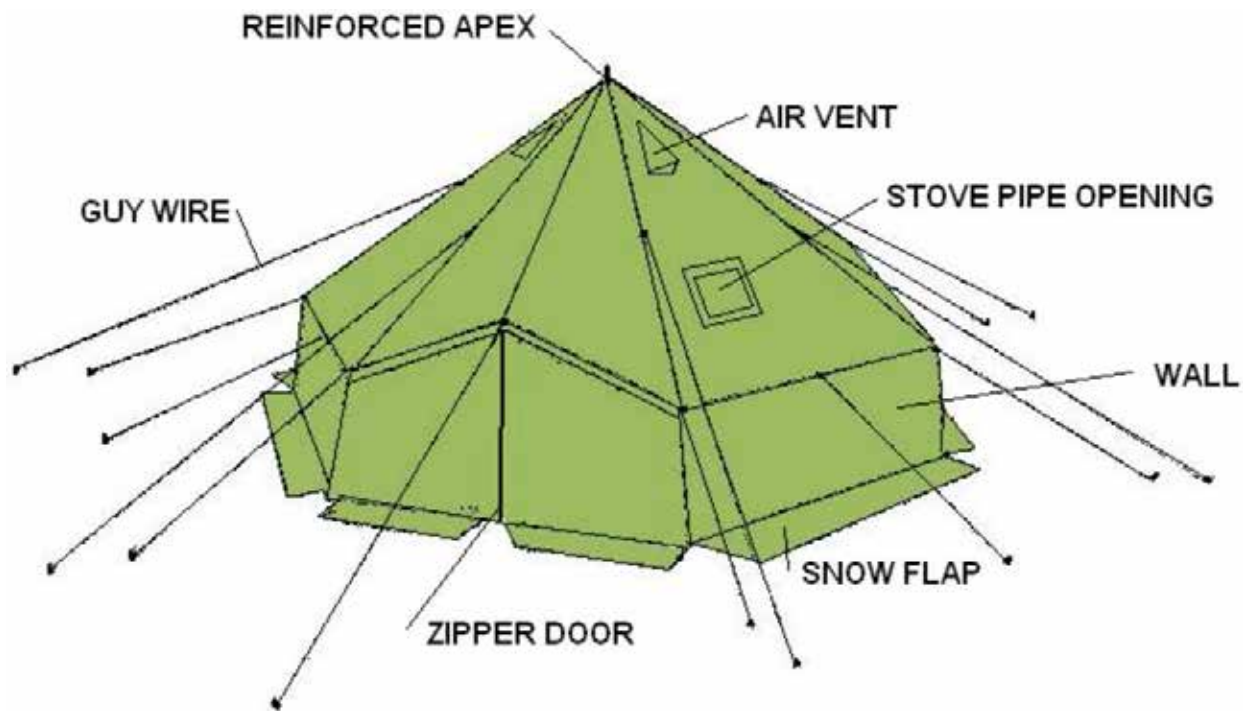

Figure 13 10-Person Arctic Tent Parts

Note. Created by Director Cadets 3, 2007, Ottawa, ON: Department of National Defence.



Figure 14 5-Person Arctic Tent

Note. From *Hero Army Surplus, Army Tents*, by heroarmysurplus.com, 2007. Copyright 2007 by heroarmysurplus.com. Retrieved December 2, 2007, from <http://heroarmysurplus.com/index.php/cPath/116?osCsid=jncvpsk59lech7i4chja975q6>



Figure 15 5-Person Arctic Tent Sleeping Arrangement

Note. From *B-GG-302-002/FP-001 Arctic and Sub-Arctic Operations, Part 1*(p. 3-11), by DND Canada, 1974, Ottawa ON: Department of National Defence. Copyright 1974 by DND Canada.



Figure 16 10-Person Arctic Tent

Note. From *Hero Army Surplus, Army Tents*, by heroarmysurplus.com, 2007. Copyright 2007 by heroarmysurplus.com. Retrieved December 2, 2007, from <http://heroarmysurplus.com/index.php/cPath/116?osCsid=jncvpsk59lech7i4chja975q6>

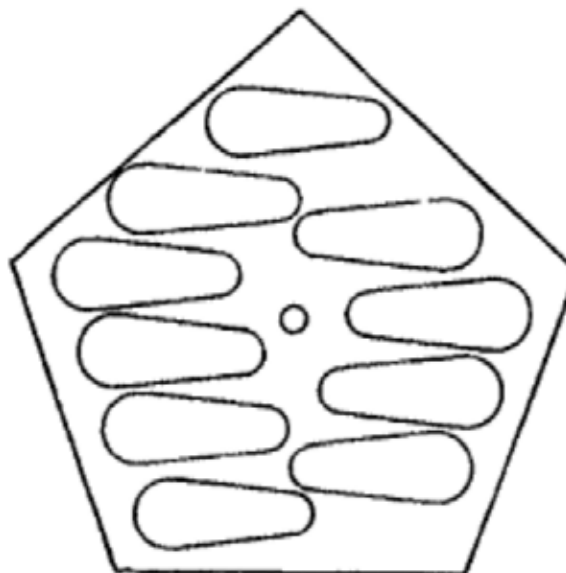

Figure 17 10-Person Arctic Tent Sleeping Arrangement

Note. From B-GG-302-002/FP-001 *Arctic and Sub-Arctic Operations, Part 1* (p. 3-12), by DND Canada, 1974, Ottawa ON: Department of National Defence. Copyright 1974 by DND Canada.

ARCTIC TENT INSPECTION

The tent must be inspected to ensure the following faults are not present:

- reinforced ring on apex damaged or torn;
- air vents are stuck closed or damaged;
- panels have tears, holes, broken threads or seams;
- guy wires or loops are either damaged or missing;
- broken or frayed guy wires or guy wire loops;
- stove pipe opening is damaged or missing;
- zipper on the outer door is broken;
- snow flaps with eyelets are torn away from the walls;
- drying line keepers are torn away from the seams;
- toggles are missing;
- telescopic pole (10-person tent) sections have bends or splits or the pole keeper pin is missing;
- tent pole (5-person tent) has bends or splits and do not fit together properly;
- base plate has cracks and, in the case of the 5-person tent, the base plate keep pin is missing; and
- pegs have broken points or bends.

ERECTING



Explain and demonstrate the following. Cadets may assist as necessary.

The only difference in erecting these two tents is the number of guy wires. On a 5-person arctic tent there are five wires and on a 10-person arctic tent there are 16. The following outlines the steps to take for erecting a 5- or 10-person arctic tent:

1. Choose a site for the tent (see TP 1 Site Selection).
2. Spread the tent out on the ground with the outside facing up.
3. Ensure the zipper is closed on the front door.
4. Check if the liner is in place; usually it is not in place in a new tent.
5. If the liner is not in place, follow these steps:
 - a. Spread out the liner above the tent with the inside of the tent facing up.
 - b. Attach the top and bottom stove pipe toggles of the liner to the tent.
 - c. Attach the remaining toggles of the liner to the tent. Use the corners of the tent as check points to make sure a toggle was not missed.
 - d. Thread the lower drying line through the drying line keepers.
6. Peg the corners of the arctic tent.
7. The tent pole will be folded in two. Straighten and lock it into position.
8. The individual (pole person) takes the pole and base plate under the canvas, going through the door and inserting it into the centre eye (reinforced apex) of the tent.
9. Secure the base of the pole onto the base plate and have the pole person hold the pole upright.
10. Before erecting the pole, drive the corner pegs into the ground.
11. Have the pole person extend the pole until the skirt and snow flaps are level with the ground. Use the pegs as a guide; they should be pulled out during this step.
12. The pole will have a shackle that needs to be lifted prior to extending. Be careful of the shackle pinching the pole person's fingers.
13. Lock the shackle into place to secure the height of the tent.
14. Pull on each of the lower guy wires and extend them in line with the seams of the tent.
15. Each guy wire will have an adjuster on it; make sure this adjuster is set to the middle position.
16. Peg the guy wires to the ground using heavy duty pegs.
17. Adjust the guy wires to remove any sag in the lower portion of the tent. The tent should be even in height all the way around.

18. Repeat Steps 14–16 with the upper guy wires. The tent guy wires should never cross with other tents.
19. Adjust and tighten all wires and prop up the door wire if necessary.
20. The two door eave wires can be propped up by placing the wire over an improvised pole, tree branch or other object higher than the door entrance. This keeps the doors from sagging and makes it easier to get in and out of the tent and gives the tent greater stability.

TEARING DOWN

Use the following steps to tear down an arctic tent:

1. Have the pole person enter the tent and hold the pole.
2. Pull out the pegs one at a time and roll up the guy wires and tie them off.
3. Have the pole person lower and remove the pole.

PACKING

Use the following steps to pack an arctic tent:

1. Lay out the tent with the tent door up and in the centre with zippers closed and remove any debris.
2. Make sure there are no double folds on the underside.
3. Hold the apex securely. The first long fold is made by folding the wings to the centre, with the pegs straight up and down.
4. Straighten and flatten out the arctic tent.
5. Fold in snow flaps across the base.
6. Make the second long fold, repeating the action for the first long fold.
7. Straighten and flatten out the arctic tent.
8. Make the third long fold, repeating the action for the first long fold.
9. Straighten and flatten out the arctic tent.
10. Make the fourth long fold by flipping the folds one on top of the other.
11. Make the first cross-fold; fold in the base to the top of the wall.
12. Make the second cross-fold by folding the apex into the base of the inserted pole section, allowing approximately 10 cm of loose fold at the base of the pole section to avoid wear and tear. The top of the pole should be offset.
13. Make the third cross-fold by placing the previous two folds one on top of the other.
14. Insert the tent, base plate and pegs into the bag.
15. Place the remaining two pole sections in the bag beside the tent.
16. Tie up the top of the tent bag.

SELECTING A CIVILIAN-PATTERN DOME TENT

To select a suitable civilian tent, consider the number of people it will need to accommodate, seasons during which it is being used, weather conditions that may be encountered, the weight of the tent and required features.

Seasons and Conditions

Three-season tents. Designed to offer good ventilation in the spring, summer, and fall, and provide sturdy weather protection in everything but heavy snowfalls and very high winds. Many three-season tents have mesh inner bodies, which reduce condensation, and can often be used without the fly for a cool, bug-proof shelter on hot nights. Three-season tents are airier, less expensive, lighter, more compact and roomier than four-season tents. Their versatility makes them popular with backpackers, paddlers, and cyclists.



Figure 18 Three-Season Tent

Note. From MEC Funhouse 4 Tent, by MEC.ca, 2007, Copyright 2007 by MEC.ca. Retrieved December 2, 2007, from http://www.mec.ca/Products/product_listing.jsp?FOLDER%3C%3Efolder_id=2534374302702837&bmUID=1196614958520

Four-season tents. Built to protect in extreme weather. They usually come with many poles and have low, curved shapes to shield high winds and reduce snow buildup. Extra guy wires provide more staking options. Fabrics tend to be heavier, with thicker waterproof coatings that make them more weatherproof, but less ventilated, and more susceptible to interior condensation. This additional protection means greater weight and packed size, and may be inappropriate for anything other than ski touring, winter camping, or mountaineering.



Figure 19 Four-Season Tent

Note. From MEC Mondarack Tent, by MEC.ca, 2007, Copyright 2007 by MEC.ca. Retrieved December 2, 2007, from http://www.mec.ca/Products/product_listing.jsp?FOLDER%3C%3Efolder_id=2534374302702837&bmUID=1196614958520

Weight

Tent weights are described as “minimum weight” and “packaged weight”. The minimum weight includes the tent and frame, and the fewest pegs and guy wires necessary to properly set up the tent. Packaged weight includes the full tent, instructions, stuff sacks, repair swatches, all guy wires and pegs. Conditions permitting, weight can be saved by leaving some pegs and components at home, and improvising with materials available at the site.

Features

Tent footprints. These are groundsheets that are custom-fit to the tent. Groundsheets protect tent floors from abrasions, increase waterproofness, and help insulate from the cool ground. Most tents have pre-made footprints, which are sold separately.

Vestibules. This is an excellent way to increase the liveability of a tent. They are useful for storing gear, to peel off wet clothing or put on boots. A pole-supported vestibule will be heavier, but generally larger and more storm-proof.

ERECTING

Setting up the Main Body

Use the following steps to set up the main body of a civilian-pattern dome tent:

1. Remove sharp objects that might puncture the tent floor. A footprint beneath the structure is not necessary for a waterproof tent, but it will reduce long-term wear on the tent floor.
2. Assemble all poles carefully.



Shock-corded poles (bungee cord) are meant to keep pole sections in the proper order, not as an automatic assembly mechanism for poles. Do not hold one section while whipping the rest of the pole back and forth, or toss the poles into the air; either procedure excessively stresses the pole joints and shock cord. Instead, fit poles together section by section, making sure that each piece slides completely into the next. Forcing an improperly assembled pole can damage the pole and / or the tent body and fly.

3. Lay the tent body flat. In windy conditions, peg all the floor corners before proceeding.
4. Lay the poles on top of the tent body so that each one crosses diagonally from one corner to the opposite corner; the two poles should cross in the centre to form an X.
5. Attach the pole clips to the canopy.
6. Fit the pole ends into the grommet tabs at the four corners of the tent.



Have one person lift the top of the tent to loft it up as the tension can cause the other poles to pop out. This is the stage when the greatest stress can be placed on the poles. There is often more than one grommet on each webbing tab to increase or decrease the tautness of the tent to compensate for fabric slackening or tightening caused by changes in humidity. When first erecting the tent, it is best to use the outermost (loosest) grommet on each tab.

7. Starting at a point over one of the doors, attach the clips on the tent to the poles.
8. Peg out the corners of the tent.



Most tents are colour-coded to help users put them up easier.

Attaching the Fly

1. Drape the fly over the tent so that the doors in the fly line up with the doors in the canopy.
2. Attach the Velcro wrap-ties to secure the fly onto the poles. They are usually on the underside of the fly on most tents. Attaching these wrap-ties is very important for strengthening the tent. The wrap-ties allow the poles to reinforce one another in a series of trusses; they also connect the corner guy wire attachment points directly to the poles for maximum stiffness when these guy wires are rigged.
3. Fit all of the grommet tabs on the fly over the appropriate pole ends.

Staking and Guying Out the Tent

Attach, peg out, and tension the four corner guy wires. Rather than thick, heavy poles for strength, most tents employ light, sturdy guy wires as part of their structure. This keeps the tents weight low. The design also makes it very important to securely rig the guy wires in any amount of wind. Not doing so could cause the tent to move in the wind (as with any tent, shelter from trees, rock, or snow walls will make for a quieter night under stormy conditions).



The pegs included with a tent are suitable for general use on relatively soft ground. On very hard-packed ground, use stakes that can withstand the force needed to secure them. On snow, sand, or other loose-packed surfaces, wider T-stakes or aluminum snow stakes will hold better; these stakes hold best buried horizontally. Improvise with other stakes (hiking staffs, ice axes, branches, rocks, trees), using the tents stake loops or cord as required.

Ventilating the Tent

Proper ventilation is the key to minimizing condensation in any tent. Some points to consider are:

- Keep fabric doors open as widely as the prevailing weather permits.
- If bugs are not a problem, leave mesh doors open.
- Open each door from the top down; warm, moist air rises and will escape through high openings.
- If the design of the tent allows, open it at either end or both sides to allow air to flow through.
- On very hot nights, when there will be no rain or dewfall, leave the flysheet off and use the inner tent to keep out bugs.

TEARING DOWN AND PACKING

The most important consideration in taking down a tent is not to stress the poles and fabrics by following these steps:

1. Disconnect guy wires and release the tension from the tent.
2. Release all the poles. If the tent has pole sleeves, push the poles out of the sleeves instead of pulling them out.
3. To minimize the stress on the bungee cord in the poles and to speed disassembly, fold each pole in half first, and then fold down towards the outsides, two sections at a time.
4. Make sure to remove all of the components from one another prior to storing. A wet tent should be dried prior to packing as the moisture will damage the tent over time.
5. If possible, fold and roll the tent rather than stuffing it into its sack. Rolling makes a smaller package, and causes fewer creases in the polyurethane coating. The tent and poles may be carried separately for easier packing or load sharing.

MAINTAINING THE TENT

Protecting the Tent

Ultraviolet (UV) damage is the largest hazard for tents. Fabrics should not be exposed to sunlight for extended periods of time; this will eventually result in colour fading and fabric failure. The uncoated fabrics of the tent canopy are most susceptible to damage from UV and should be covered by the more durable fly. If extended exposure is unavoidable, cover the tent with a tarp or a sheet of nylon.

Lighting the Tent

Using a candle lantern in a tent carries definite risks. Never leave a candle lantern burning unattended; always watch for fire hazards from overheating fabrics or spilling wax. Spilling wax can be dangerous, particularly to eyes and other sensitive areas. Use candle lanterns wisely and with extreme caution. Cooking in a tent is strongly discouraged because of fire hazards and carbon monoxide inhalation risks. Unlike campfire smoke and other fumes, carbon monoxide can render someone unconscious without warning.

Not Eating in the Tent

Mop up spills promptly with water. Many foods, particularly acidic ones like fruit or juices, can weaken synthetic fabrics over time. It is best to eat and store food away from a tent to avoid attracting animals.

Cleaning the Tent

Clean the tent by hand while it is set up, using a sponge, a mild non-detergent soap, and warm water. Rinse thoroughly. Do not dry clean, machine wash, or machine dry. Stubborn stains like tar can be left in place and dusted with talcum powder to prevent transfer to other areas of the tent in storage. After cleaning, a spray-on water repellent designed for synthetic fabrics may be applied to the flysheet if surface water repellent is weakened. This is apparent when water droplets no longer bead on the fabric. If the poles are exposed to salt or salt water, rinse them in fresh water and allow them to dry before storing (while aluminum does not rust, it can become brittle through unseen corrosion over time).

CONFIRMATION OF TEACHING POINT 3

The cadets' participation in erecting, tearing down and packing an arctic tent or civilian-pattern tent will serve as the confirmation of this TP.

END OF LESSON CONFIRMATION

The cadets participation in erecting, tearing down and packing a modular tent and either an arctic tent or civilian-pattern tent will serve as the confirmation of this lesson.

CONCLUSION

HOMEWORK / READING / PRACTICE

Nil.

METHOD OF EVALUATION

Nil.

CLOSING STATEMENT

It is important for the cadets to be able to setup / tear down a modular tent because they are often used during aircrew survival exercises. A cadet's understanding of this lesson will allow them to better assist in the set-up of a aircrew survival exercise.

INSTRUCTOR NOTES / REMARKS

If the squadron does not have access to modular tents, have the cadets erect, tear down and pack the arctic tent and the civilian-pattern tent.

Cadets who are qualified Survival Instructor may assist with this instruction.

REFERENCES

A3-059 C-87-110-000/MS-000 Canadian Forces. (1983). *Operational support and maintenance manual: Tent, main*. Ottawa, ON: Department of National Defence.

A3-060 B-GG-302-002/FP-001 Canadian Forces. (1974). *Arctic and Sub-Arctic operations: Part 1*. Ottawa, ON: Department of National Defence.

THIS PAGE INTENTIONALLY LEFT BLANK

FOLDING A SINGLE TENT SECTION

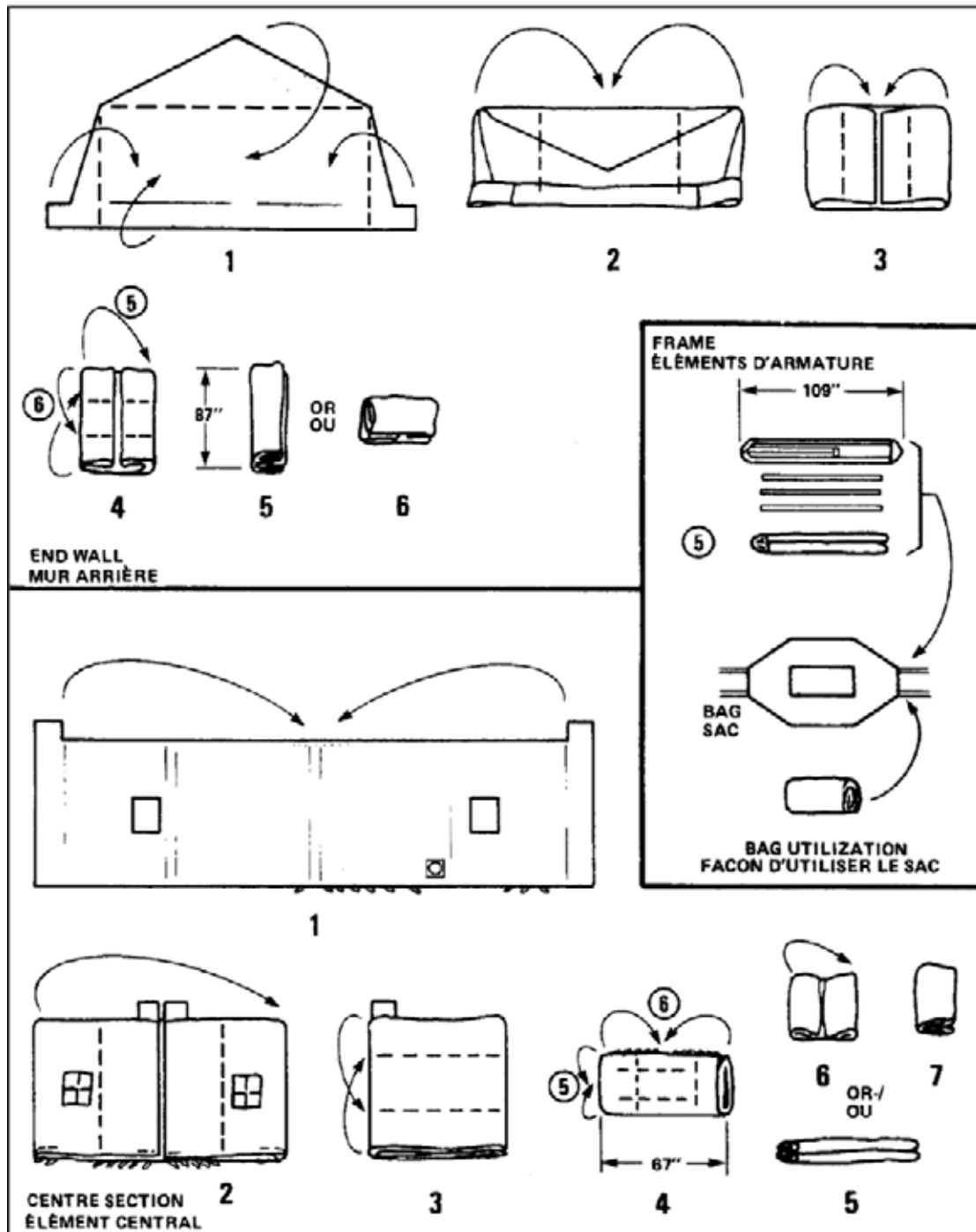

Figure A-1 Folding a Single Tent Section

Note. From C-87-110-000/MS-000 Operational Support and Maintenance Manual for Tent, Main(p. 2-17), by DND Canada, 1983, Ottawa ON: Department of National Defence. Copyright 1983 by DND Canada.

FOLDING LACED TENT SECTION

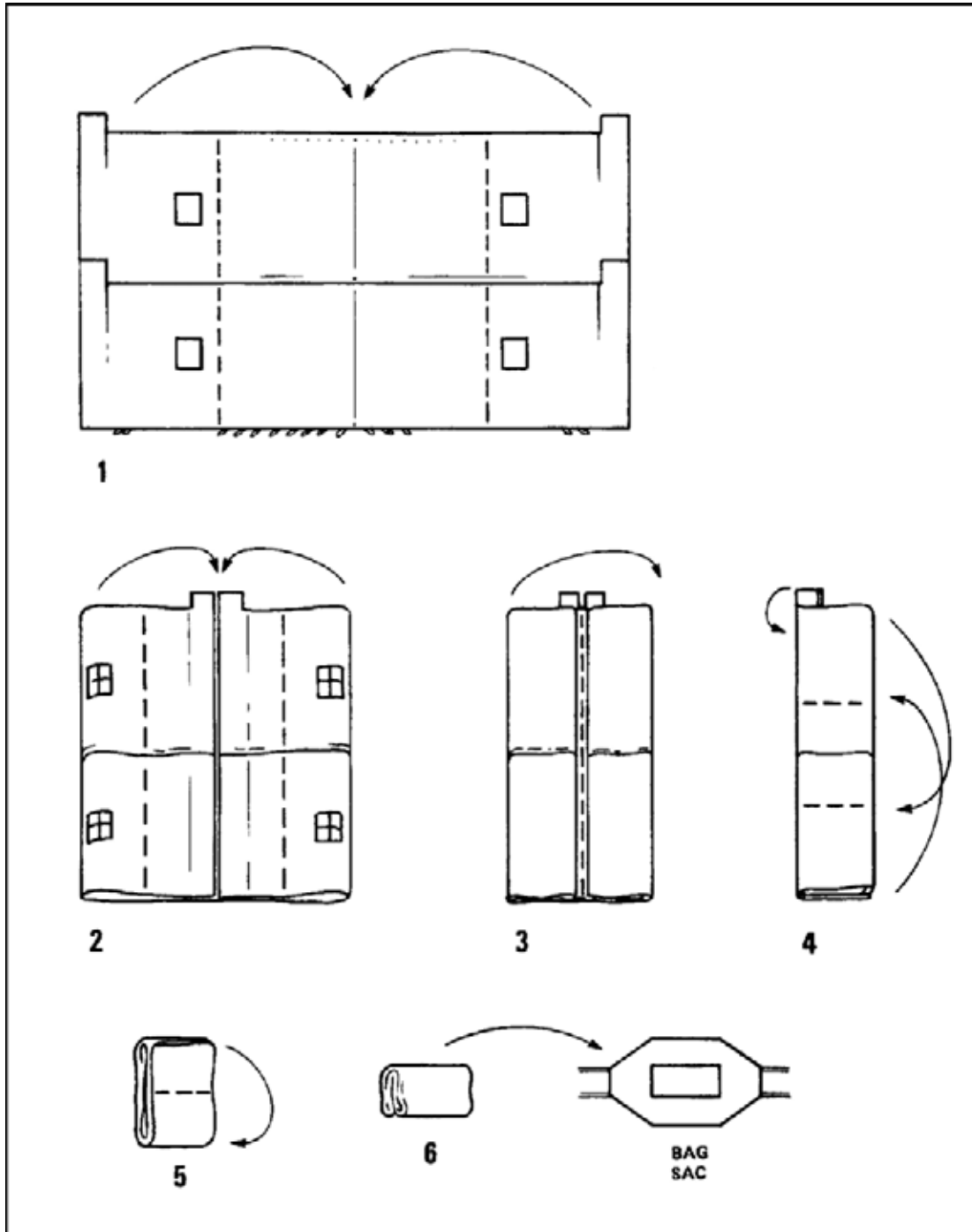

Figure A-2 Folding Laced Tent Sections

Note. From C-87-110-000/MS-000 *Operational Support and Maintenance Manual for Tent, Main*(p. 2-18), by DND Canada, 1983, Ottawa ON: Department of National Defence. Copyright 1983 by DND Canada.